

TYP 202

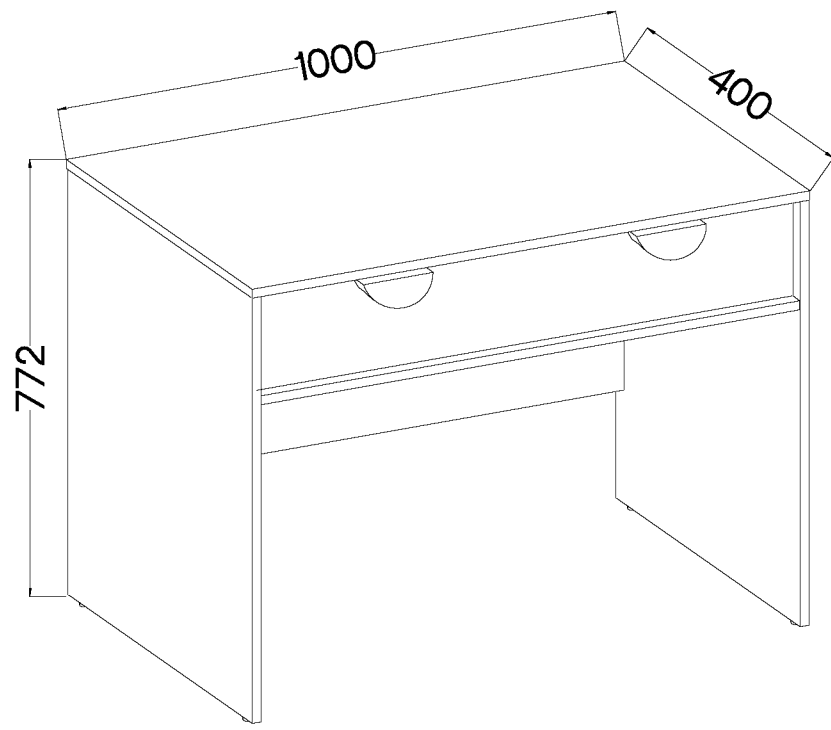

 †8x30mm A 20 L=20mm	 †6x42mm B2 4	 †15/12mm C 24	 †12/10mm C5 4	 †15x5mm D2 28	 E 4	 F4 4	 27/310mm I4 2	 †20/8mm J14 4	 L 4	 †6,3x13mm M2 8	 †6.3x20mm M3 4	 †4.0x30mm R2 4	 L=96mm S 2	 M4x9mm U1 4
---	-------------------------------	--------------------------------	--------------------------------	--------------------------------	-------------------	--------------------	--------------------------------	--------------------------------	-------------------	---------------------------------	---------------------------------	---------------------------------	-----------------------------	------------------------------

ISM-VIS-008

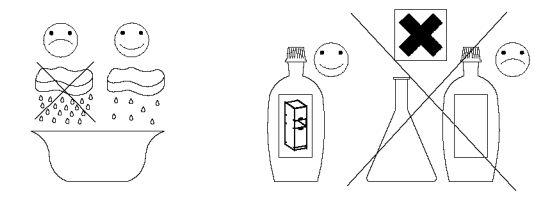
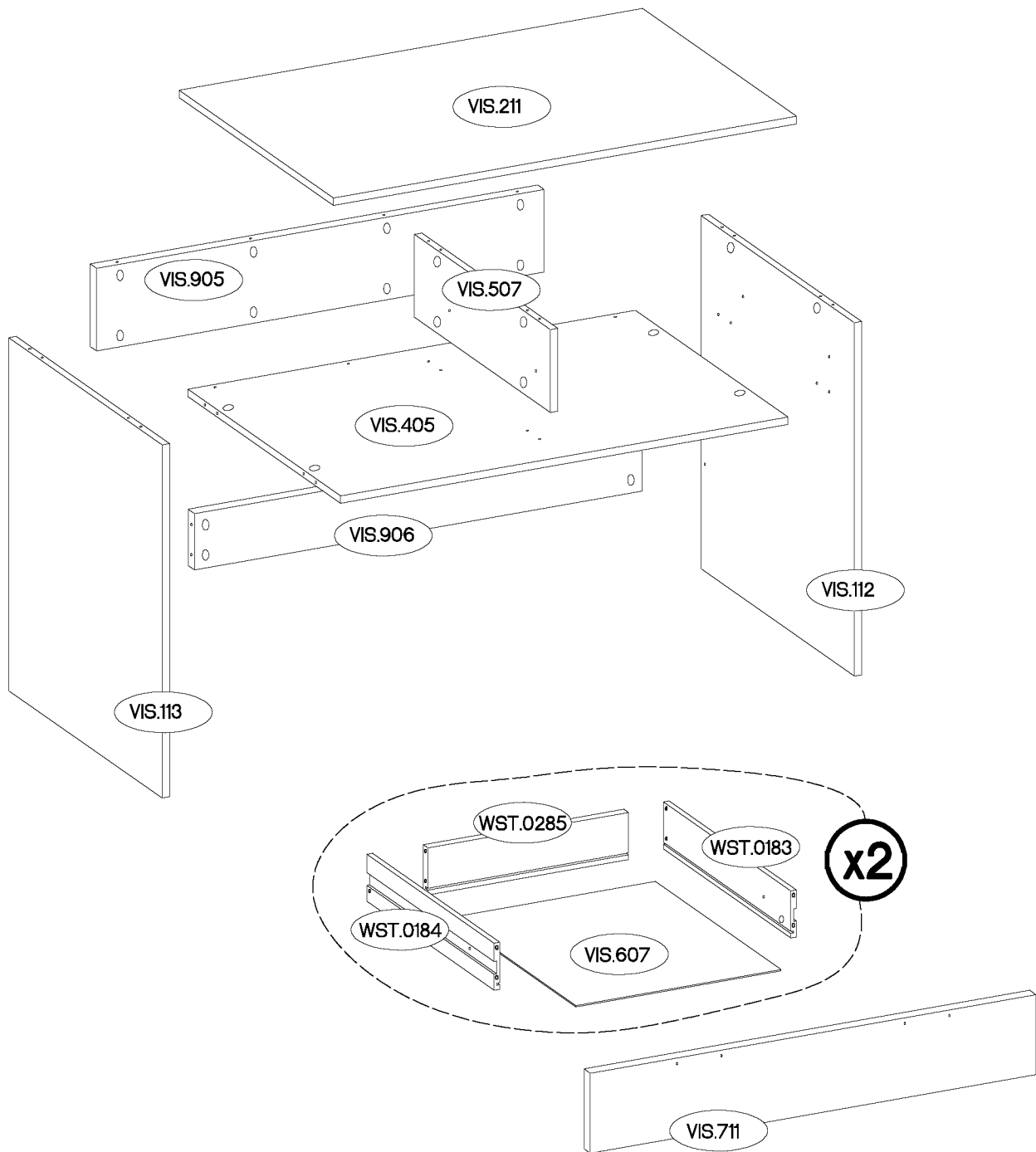

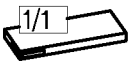
	Ersatzteil Nummer	Dimension
	VIS.112	751x398x16
	VIS.113	751x398x16
	VIS.507	176x353x16
	VIS.211	1000x400x16
	VIS.405	966x396x16
	VIS.905	966x120x16
	VIS.607	444x327x2,5
	WST.0183 x2	330x100x12
	WST.0184 x2	330x100x12
	WST.0285 x2	433x100x12
	VIS.711	170x962x16



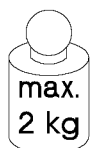

VIS.211



VIS.607

1

+12/10mm  C5 4	+8x30mm  A 8
---	---

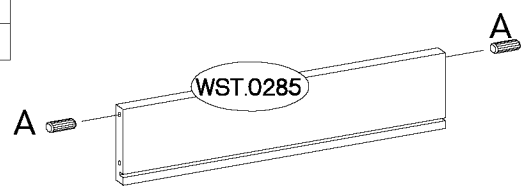
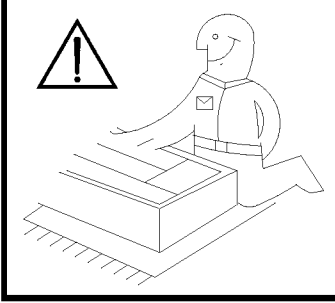

x2

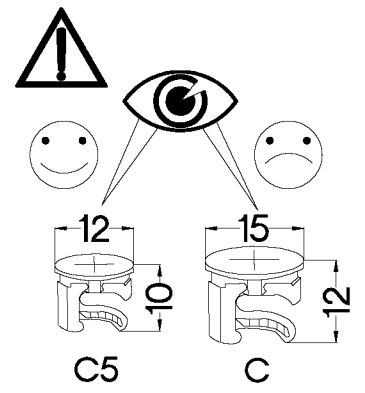
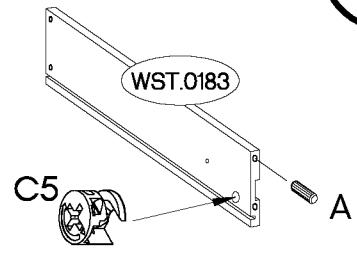
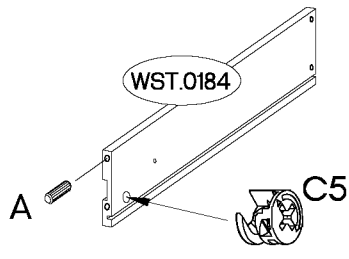

2

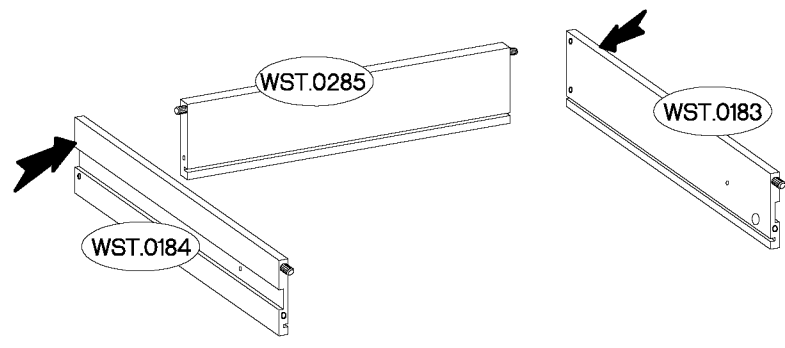

x2

+6x42mm  B2 4

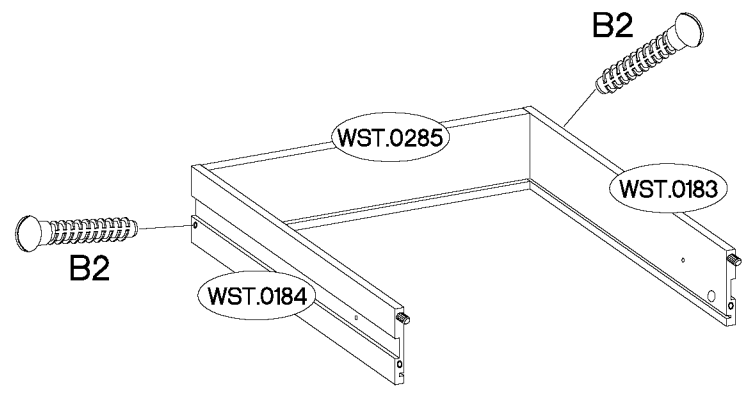
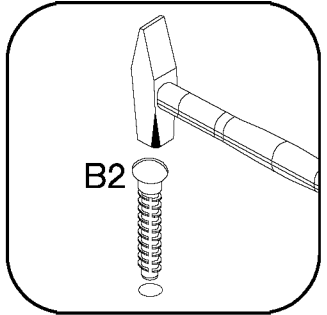

3

L=20mm  D2 4
--

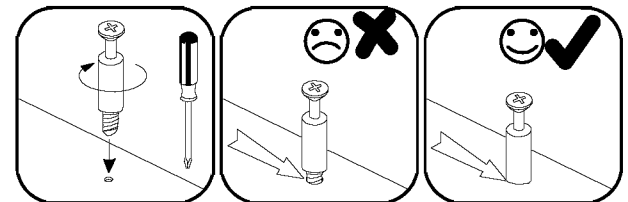
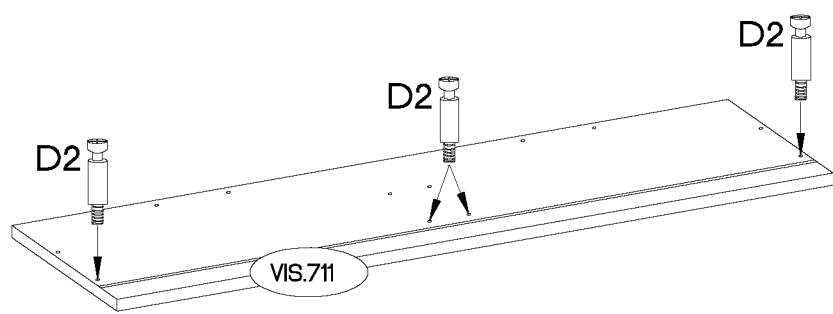



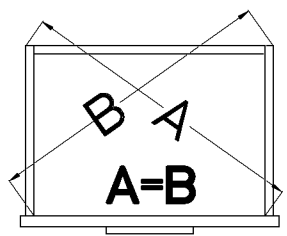
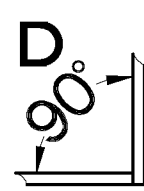
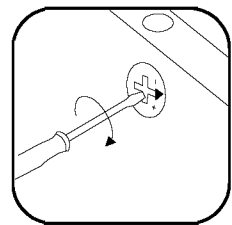
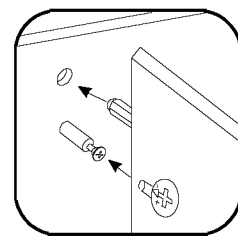
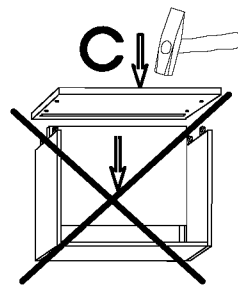
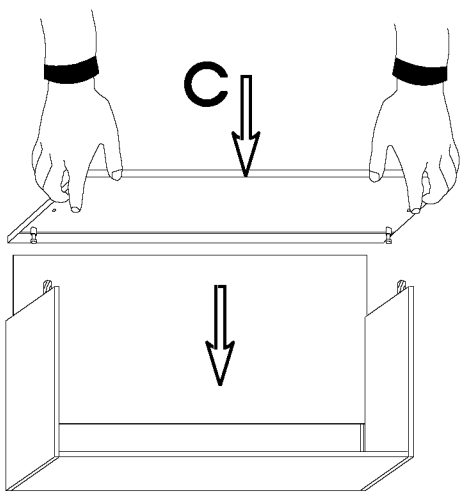
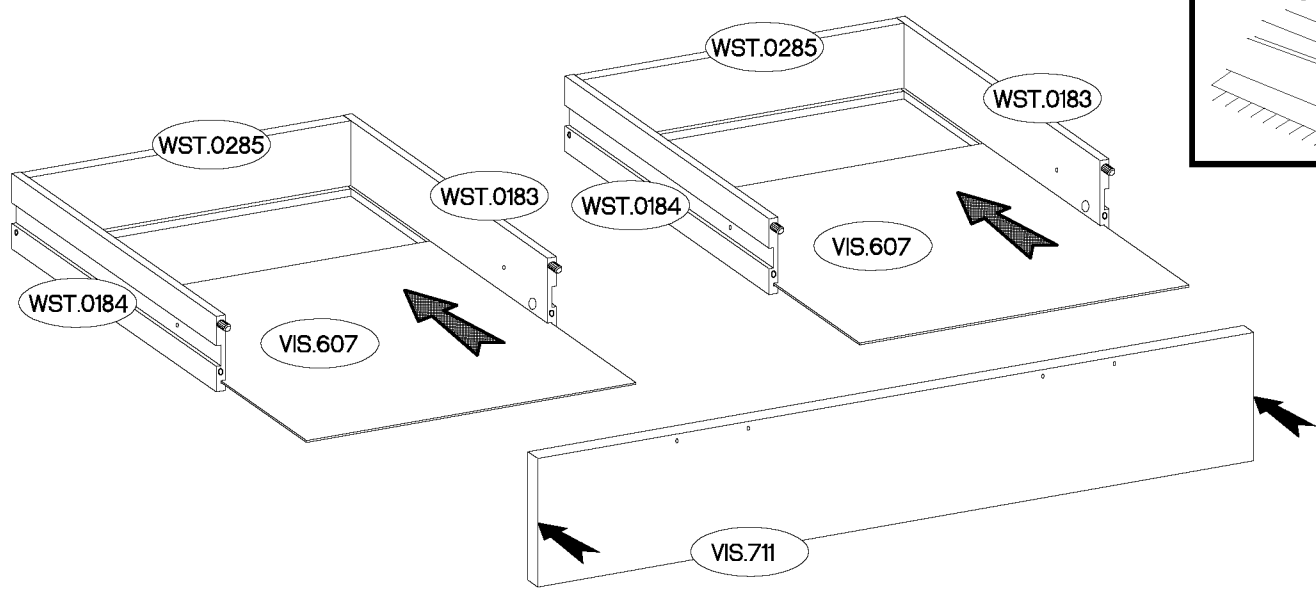
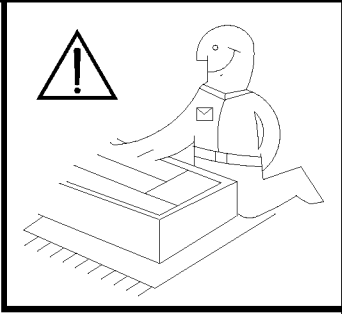

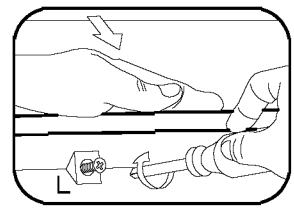
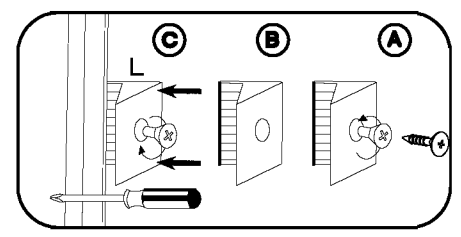
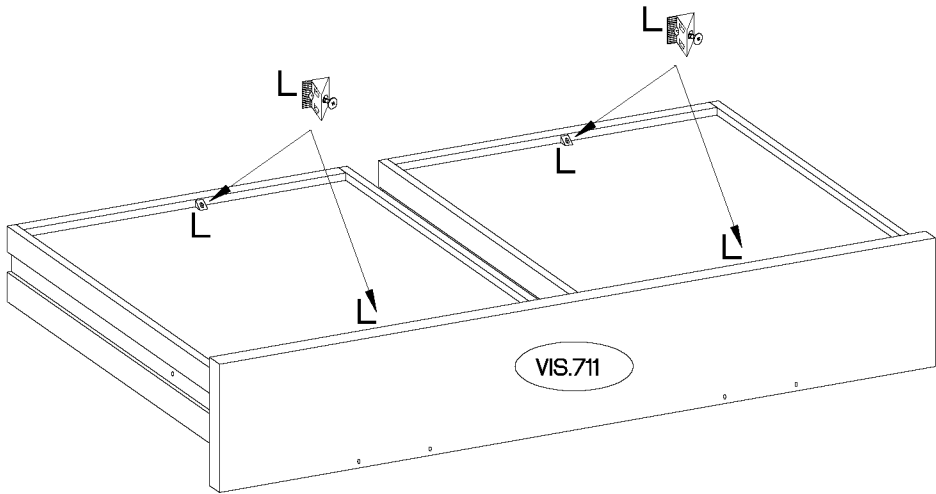
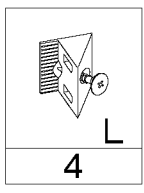

4

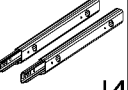

5



+8x30mm	+15/12mm	L=20mm	27/310mm	+15x5mm	+6,3x13mm	+6.3x20mm	+20/8mm
							
A	C	D2	I4	F4	M2	M3	J14
8	8	8	2	4	8	4	4

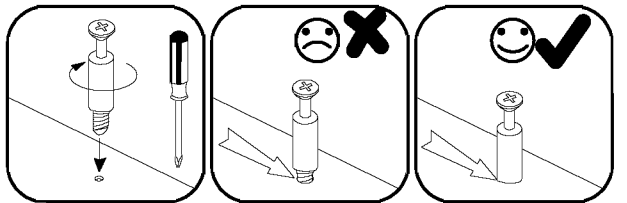
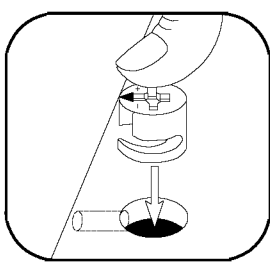
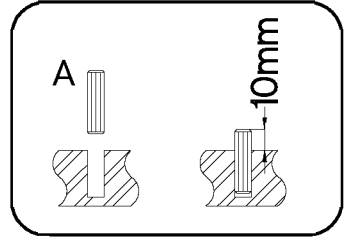
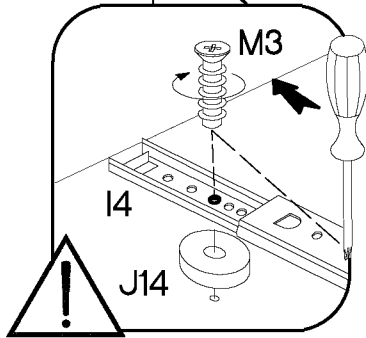
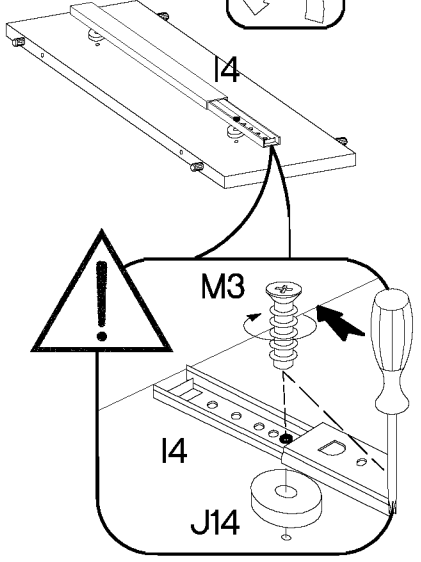
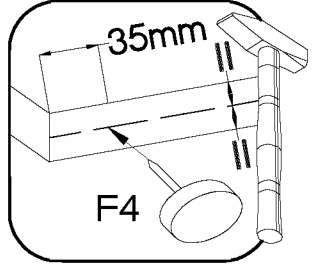
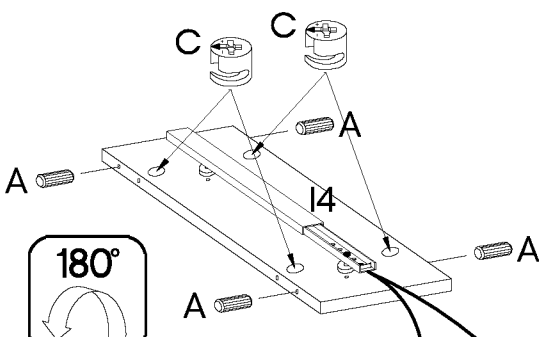
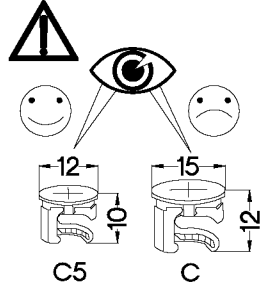
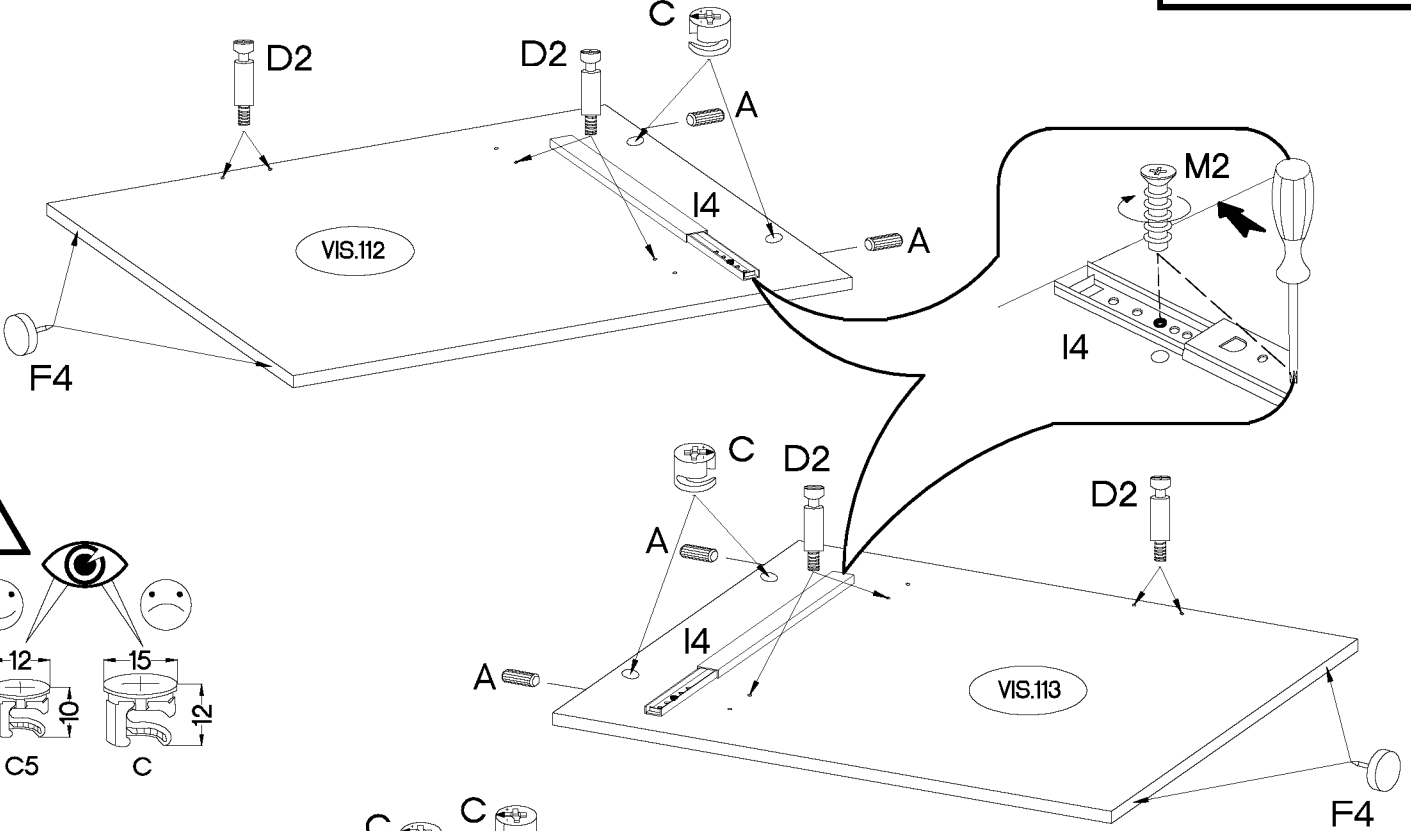
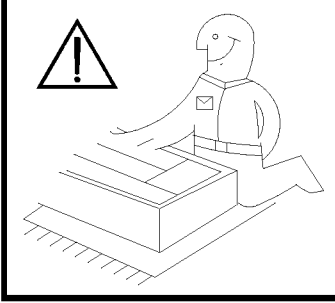

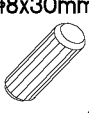
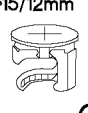
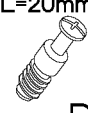
$\pm 8 \times 30 \text{mm}$ 	$\pm 15/12 \text{mm}$ 	$L=20 \text{mm}$ 
A	C	D2
4	16	16

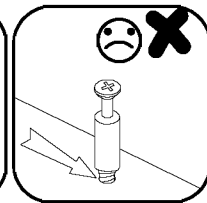
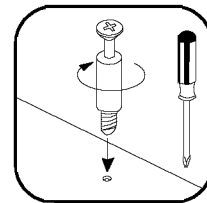
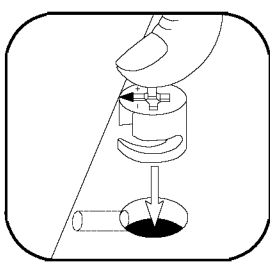
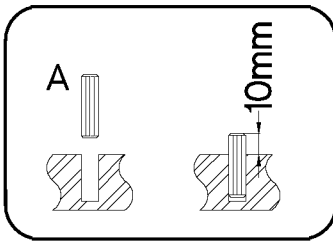
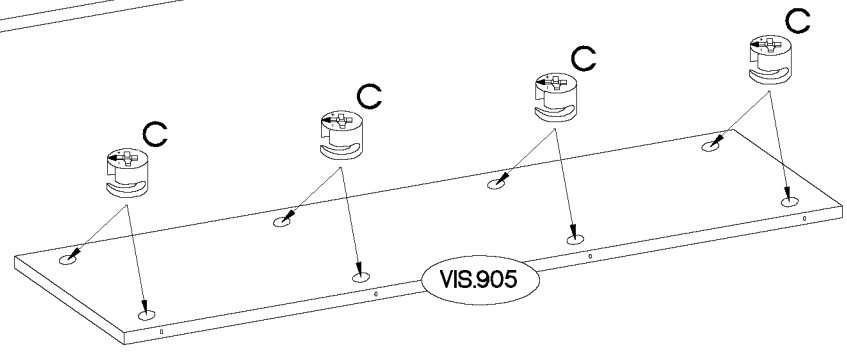
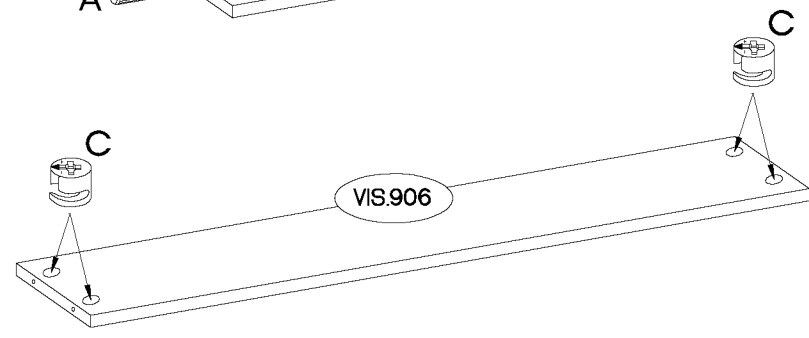
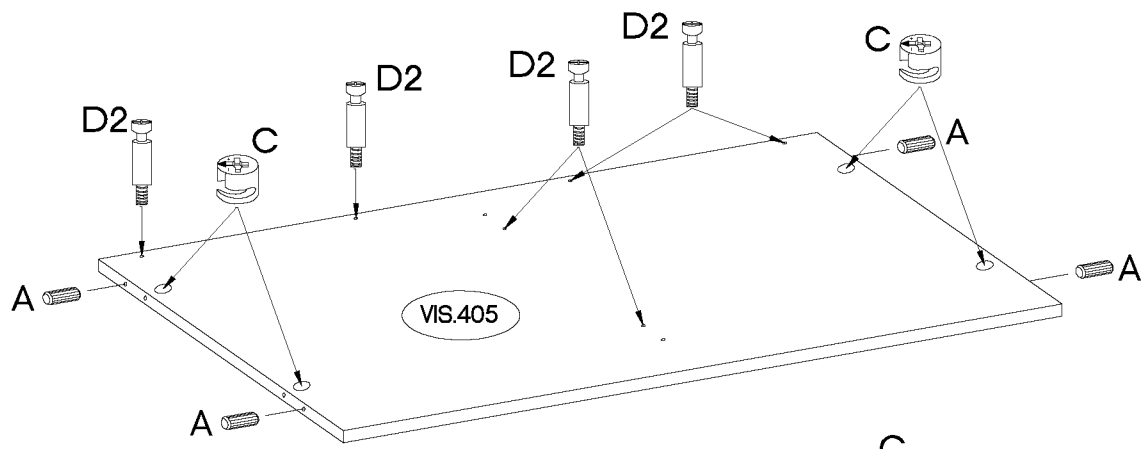
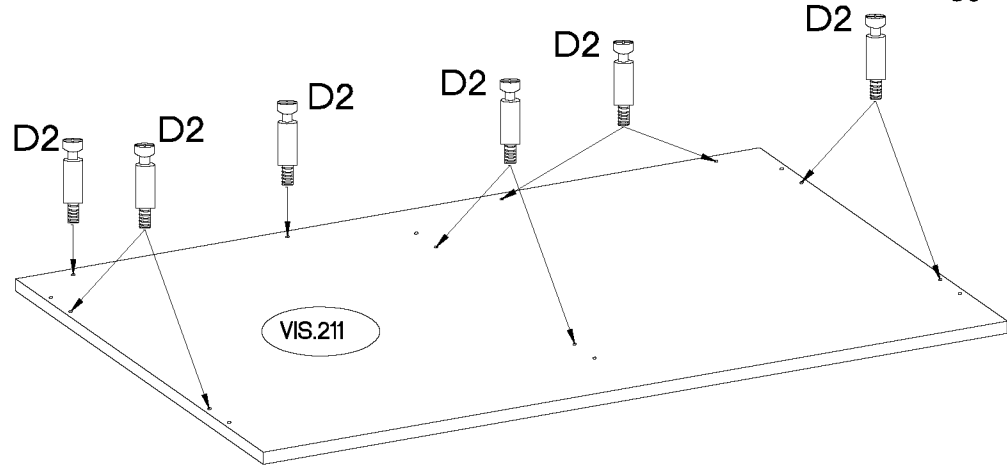
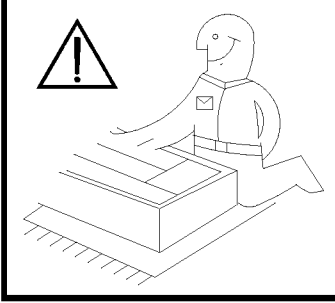
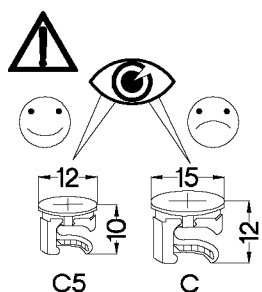



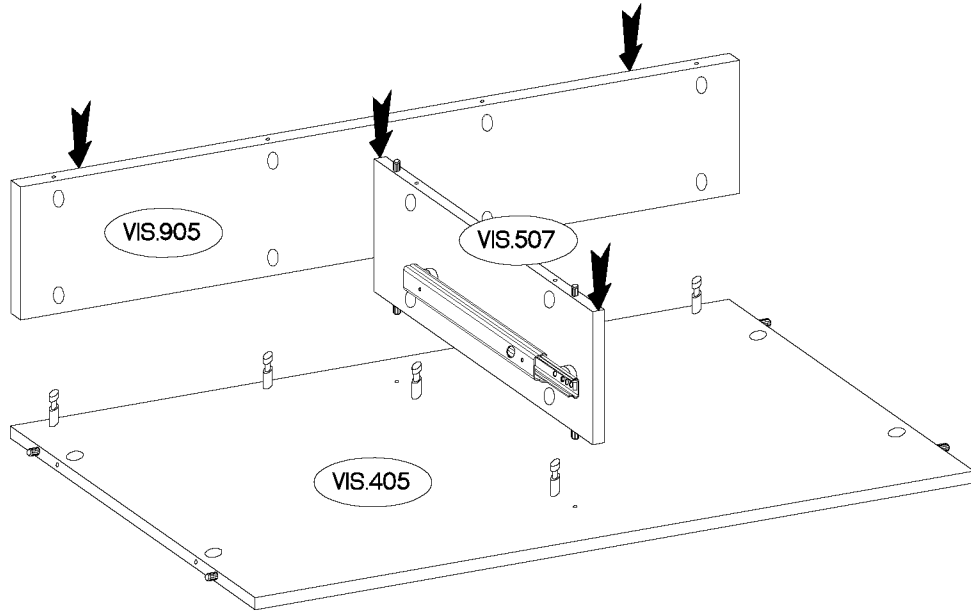

8

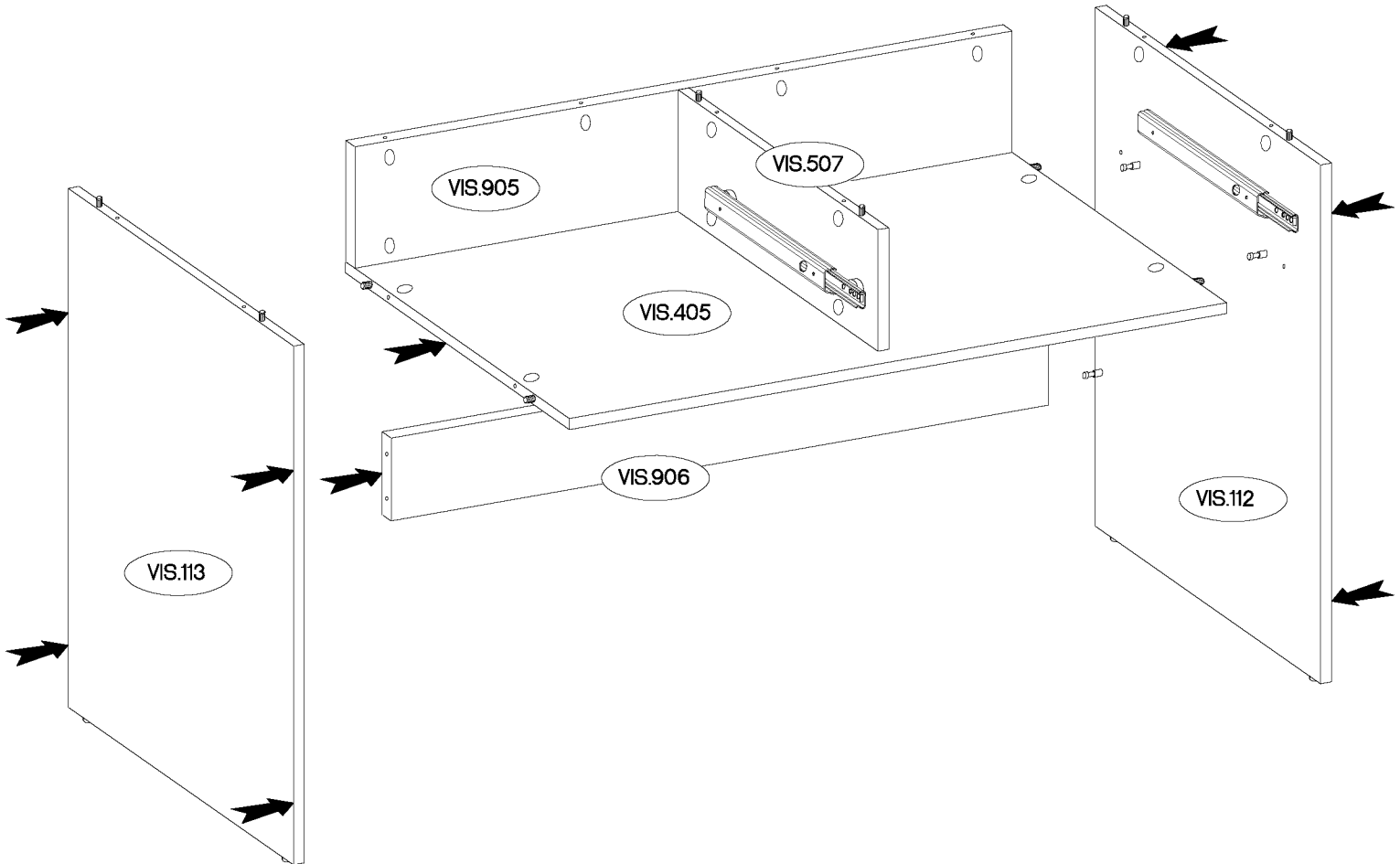
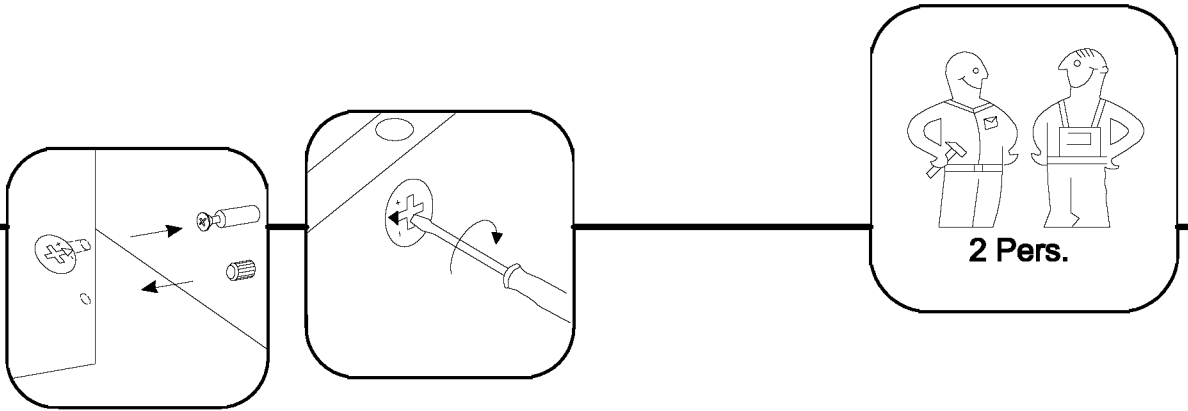

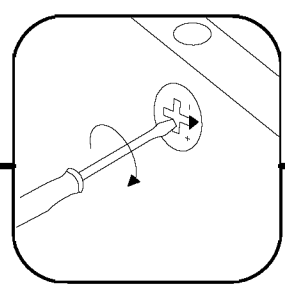
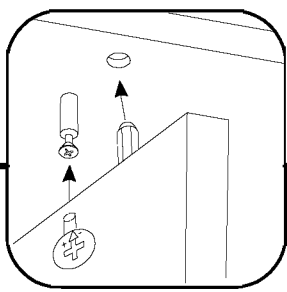
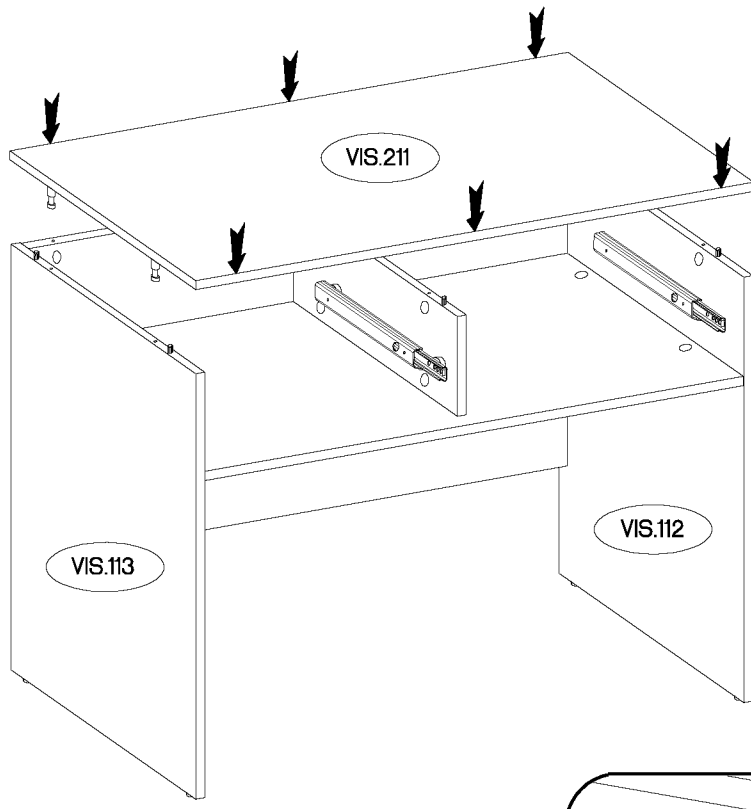
9





L=96mm	+4.0x30mm	M4x9mm	
			
S	R2	U1	E
2	4	4	4

