

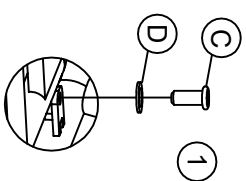

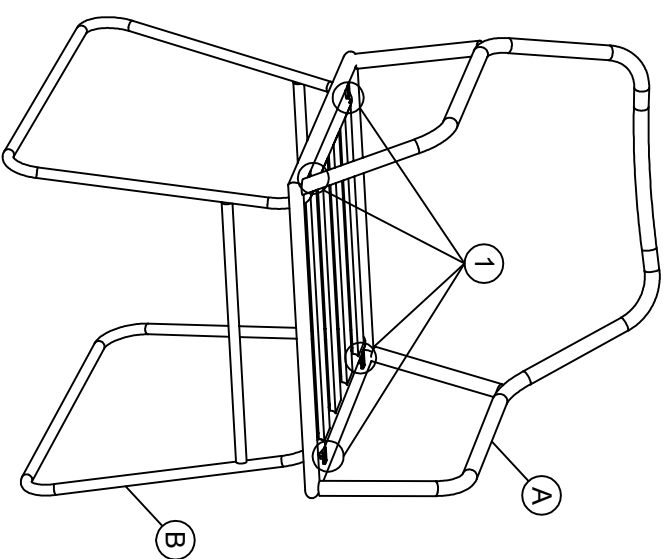

Step 1

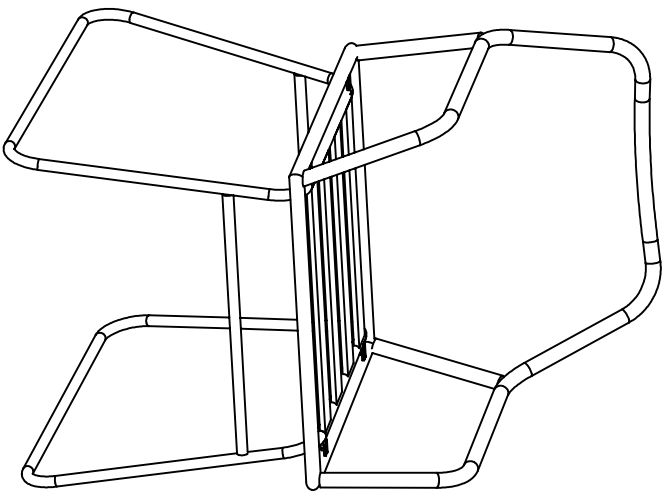
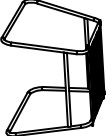

	A*1		B*1		C*4 Bolt M6*15		D*4 M6 flat washer
-----------------------------------------------------------------------------------	-----	-----------------------------------------------------------------------------------	-----	-----------------------------------------------------------------------------------	-------------------	-----------------------------------------------------------------------------------	-----------------------