

**INSTALLATION****KRETSSCHEMAN**

Nedan återfinns kretsscheman för felsökning. Notera modellnumren, som återfinns på enheterna.

**INSTALLASJON
ELEKTRISITET****ELEKTRISKE SKJEMA**

Nedenfor er kretsskjemaer for feilsøking. Noter modellnummer, funnet på enhetenes navneskilt.

**ASENNUS
SÄHKÖ****SÄHKÖ KAAVIOITA**

Alla Kaavio vianmäärittys. Huomaa malli numero, joka löytyy vastaavat osat.

**INSTALLATION
ELECTRICAL****ELECTRICAL SCHEMATICS**

Below are schematics for troubleshooting. Note the model numbers, findable on each part.

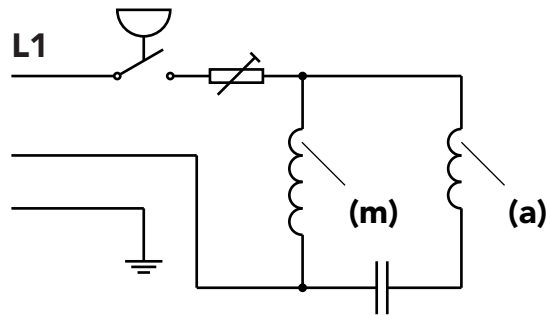
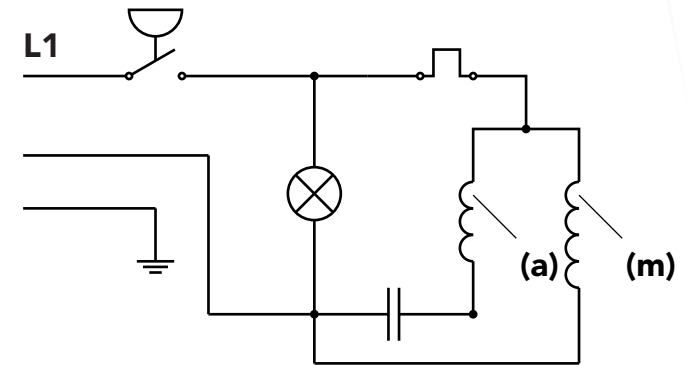
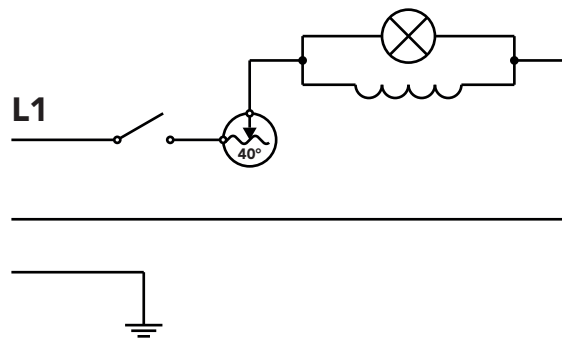
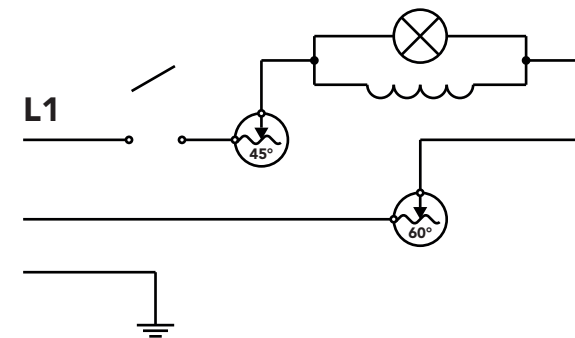
DXD**DXD-310****LX[®]****TDA09****SDP-1500****HRC-31**

Copyright ©2017 Bygghemma Sverige AB. All rights reserved. Bygghemma Group Nordic AB is the registered holder of the bathlife® logo.



Information contained within this document was considered accurate at the time of publication, but may be subject to revision.



Some colours are based on the PANTONE® Colour Matching System. Colours may present differently in digital and physical formats.

emv_bathtub_connections

v1.2



EL (FORTS.)



ELKOPPLINGSSCHEMA

Lokala lagar och föreskrifter gäller alltid före manualen.



ELEKTRISITET (FORTS.)



ELEKTRISK TILKOBLING

Lokale lover og forskrifter har alltid prioritet over håndboken.



SÄHKÖ (JATKUI)



SÄHKÖJOHDOT

Paikalliset lait ja määräykset korvaavat aina käsikirjan.



ELECTRICAL (CONT.)



ELECTRICAL INSTALLATION

Local laws and regulations always supersede the manual.

+ **1500W** (≈6,6A)
 VITAL x ECO x PLUS ✓

+ **700W** (≈3,1A)
 VITAL x ECO ✓ PLUS ✓

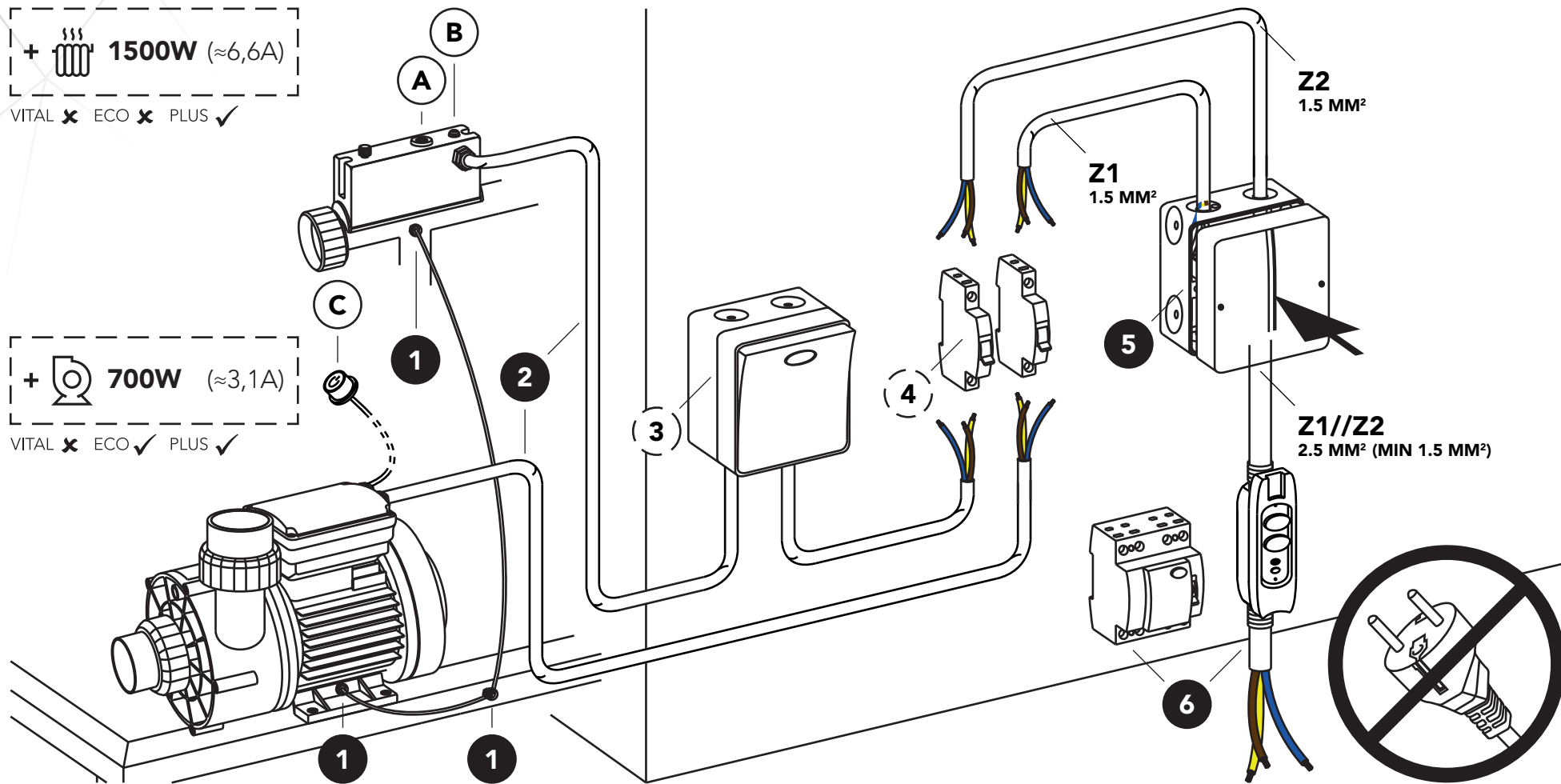

Copyright ©2017 Bygghemma Sverige AB. All rights reserved. Bygghemma Group Nordic AB is the registered holder of the bathlife® logo.



Information contained within this document was considered accurate at the time of publication, but may be subject to revision.



Some colours are based on the PANTONE® Colour Matching System. Colours may present differently in digital and physical formats.



EL (FORTS.)

- 1 Jord**
Anslut jordkablarna till en gemensam punkt på stålramen.
- 2 Ledare**
1-fas, 230V 50Hz. Fas (brun), neutral (blå) & jord (gul). Effekt och kabelarea, förra sidan.
- 3 Strömbrytare (ej krav)**
Endast rek. Värmaren aktiveras automatiskt med pumpen. Med brytare kan den slås av separat.
- 4 Trög automatsäkring (ej krav)**
Endast rek. Kan skydda vid strömöverslag. Lämpliga vid parallella (1x16A) lösningar.
- 5 Kopplingsdosa**
Anslut antingen parallellt (1x16A), eller till separata faser (2x10A).
- 6 Jordfelsbrytare (ingår ej)**
Max 30mA. Använd ALLTID en jordfelsbrytare, på gemensam ledare eller i elcentralen.
- A Omstartsknapp (ej alla värmare)**
Startar om värmaren vid problem.
- B Statuslampa (ej alla värmare)**
Lyser när värmaren är aktiv.
- C Strömknapp**
Slår av/på pumpen. Sitter på karet.
- Behörig?**
Installation skall ALLTID utföras av behörig hantverkare.
- Se upp för skadade kablar**
SLUTA använda vid kabelskada.



ELEKTRISITET (FORTS.)

- 1 Jording**
Forbinder de jordledning(er) til et felles punkt på stålrammen.
- 2 Leder**
1-fase, 230V 50Hz. Fase (brun), nøytral (blå) & jording (gul). Effekt og tverrsnitt, forrige side.
- 3 Strømbryter (ikke krav)**
Bare anbefaling. Varmer kjøres automatisk sammen med pumpen. Med bryteren kan slås av separat.
- 4 Tøff automatsikring (ikke krav)**
Bare anbefaling. Kan beskytte kraft-overbelastning. Egnert for parallell (1x16A) løsninger.
- 5 Koblingsboks**
Tilkobling enten parallellt (1x16A), eller til separate faser (2x10A).
- 6 Jordfeilbrytere (ikke inkl.)**
Max 30mA. Bruk ALLTID en jordfeilbryter, enten den felles leder eller fordelingsboks.
- A Nullstillknapp (ikke alle varmer)**
Nullstill varmer i tilfelle problemer.
- B Statuslampe (ikke alle varmer)**
Lyser når varmer er på.
- C På-knapp**
Slår av/på pumpen. Sitter i karet.
- Kvalifisert?**
All installasjon skal ALLTID utføres av kvalifiserte håndverkere.
- Pass på skadede kabler**
IKKE bruk hvis kabelskade.



SÄHKÖ (JATKUI)

- 1 Maakaapeli**
Liitä kaikki johdot yhteen pisteeseen teräskehys.
- 2 Johdinvaijerin**
1-vaihe, 230V 50Hz. Vaihe (ruskea), neutraali (sininen) & maa (keltainen). Virta/alue, edelli. sivu.
- 3 Virtakytkin (ei vaadittu)**
Suositus vain. Lämmitin automaattisesti aktiivinen pumppu. Kytkin sallii sen ottamista pois käytöstä.
- 4 Viive auto.katkaisija (ei vaadittu)**
Suositus vain. Suojaus Suuri virta. Hyödyllisiä rinnakkaisia (1x16A) asetuksia varten.
- 5 Haaroitusrasia**
Kytketty joko rinnan (1x16A), tai kahdessa eri vaiheessa. (2x10A).
- 6 Vikavirtasuojien (ei sisälly)**
Max 30mA. AINA käyttää vikavirtasuojien, liitetyssä johdinvaijerin tai jakokoteloon.
- A Nollaus painike (tiettyjä malleja)**
Nollata toimintahäiriö lämmitin.
- B Tililmaisain (tiettyjä malleja)**
Sytty, kun lämmitin on aktiivinen.
- C Virtapainike**
Kytke pumppu päälle/pois päältä.
- Pätevä?**
AINA palkata lisensoitu ammattilainen suorittamaan asennus.
- Varokaa johdoissa vaurioita**
Jos kaapelin vaurioita, ÄLÄ käytä.



ELECTRICAL (CONT.)

- 1 Ground**
Connect ground wire(s) to a unison point on the steel frame.
- 2 Conductor**
1-phase, 230V 50Hz. Phase (brown), neutral (blue) & ground (yellow). Power/area, prev. page.
- 3 Power switch (not required)**
Recommended only. Heater automatically activates with the pump. A switch allows disabling it.
- 4 Slow blow MCB (not required)**
Recommended only. Can protect components from excess current. Useful for parallel (1x16A) setups.
- 5 Coupling box**
Connect either in parallel (1x16A) or to separate phases (2x10A).
- 6 GFCI/RCD (not included)**
Max 30mA. ALWAYS use a GFCI/RCD, on a joint conductor or in the distribution box.
- A Reset button (not on all heaters)**
Resets a malfunctioning heater.
- B Status lamp (not on all heaters)**
Is lit when the heater is active.
- C Power button**
Turns on/off pump. Found on tub.
- Certificated?**
Work should ALWAYS be carried out by a certificated professional.
- Beware damaged cabling**
STOP using if a cable is damaged.



Copyright ©2017 Bygghemma Sverige AB. All rights reserved. Bygghemma Group Nordic AB is the registered holder of the bathlife® logo.



Information contained within this document was considered accurate at the time of publication, but may be subject to revision.



Some colours are based on the PANTONE® Colour Matching System. Colours may present differently in digital and physical formats.



INSTALLATION



ENGREPPSBLANDARE

Följ denna guide om karet har engreppsblandare. Lokala lagar och föreskrifter går före manualen.

INSTALLASJON
VANN

ENGREPPSBATTERI

Følg denne veiledningen på karet har engreppsbatteri. Lokale lover og forskrifter kommer før boken.

ASENNUS
VESI

YHDEN KÄDENSIJAN MIKSERI

Seuraa, jos ammeessa on yhden kädensijan mikseri. Paikallisia lakeja ja säädöksiä etusijalla.

INSTALLATION
WATER

SINGLE GRIP MIXER

Follow this guide if the tub has a single grip mixer. Local laws and regulations supersede the manual.

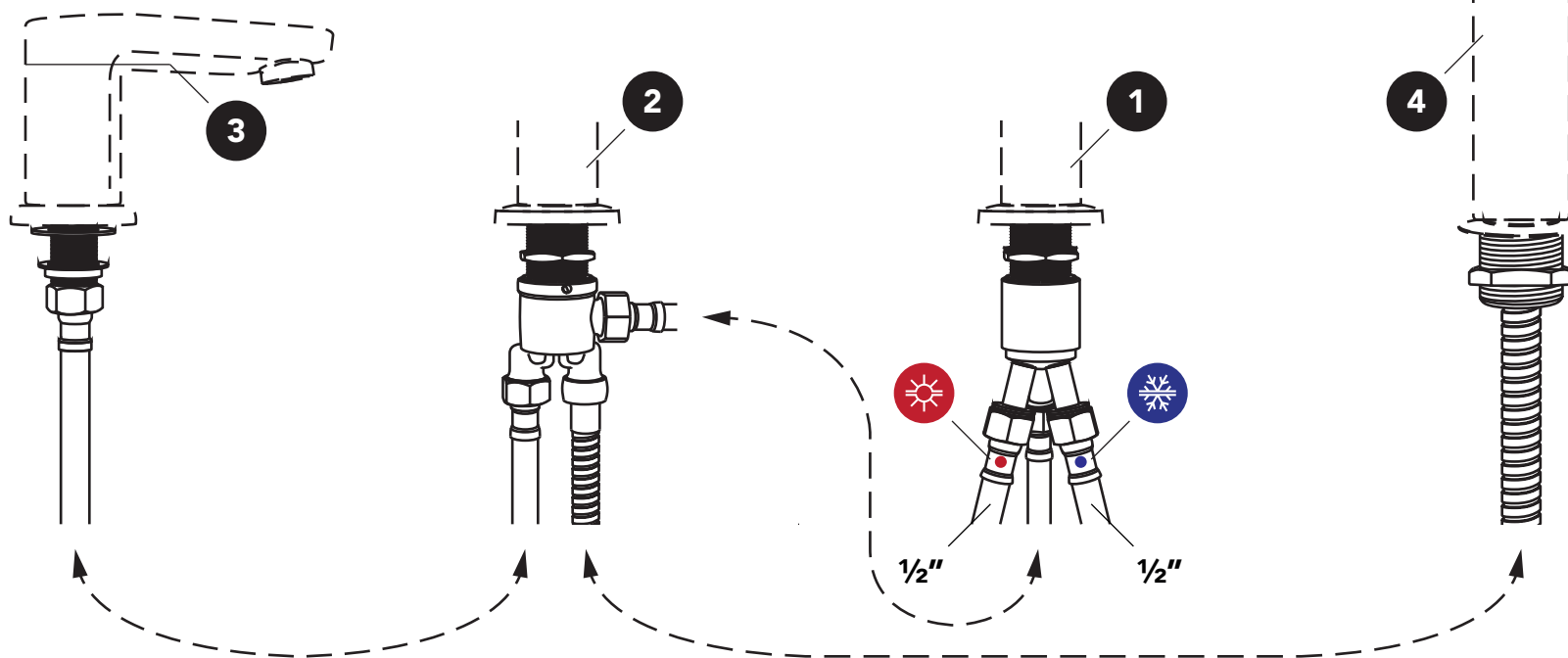
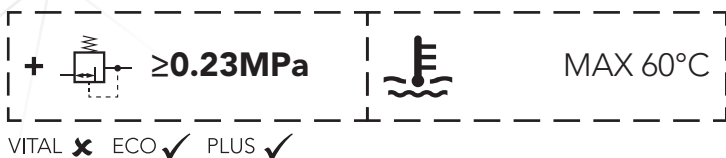

Copyright ©2017 Bygghemma Sverige AB. All rights reserved. Bygghemma Group Nordic AB is the registered holder of the bathlife® logo.



Information contained within this document was considered accurate at the time of publication, but may be subject to revision.





Some colours are based on the PANTONE® Colour Matching System. Colours may present differently in digital and physical formats.

emv_bathtub_connections

v1.2



VATTEN (FORTS.)

- 1 Engreppsblandare ***
Kopplas samman med utflödesblandaren. Här ansluts inkommande varm- och kallvatten.
 - 2 Utfloëdesblandare ***
Kopplas samman med engreppsblandaren. Här ansluts även alla munstycken.
 - 3 Kran ***
Tappkran eller vattenfall. Aktiveras med hjälp av utfloëdesblandaren.
 - 4 Dusch, handhållen ***
Kan lyftas ur sitt fäste. Aktiveras med hjälp av utfloëdesblandaren.
-  **Varmvattenanslutning**
Maxtryck ≥ 0.23 MPa. Maxtemp. (blandat flöde) 60°C. 1/2"-koppling.
-  **Kallvattenanslutning**
Maxtryck ≥ 0.23 MPa. Maxtemp. (blandat flöde) 60°C. 1/2"-koppling.
-  **Behörig?**
Installation skall ALLTID utföras av behörig hantverkare.
-  **Se upp för läckande kopplingar**
REPARERA läckor och andra skador i rör och slangar omedelbart när de upptäcks.

* Kranar, blandarhuvuden och munstycken kan variera mellan olika varianter av produkten. Installationsförfarandet är dock detsamma för alla varianter.







VANN (FORTS.)

- 1 Engreppsbatteri ***
Kobles til utstrømningsbatteri. Forbinder innkommende varmt og kaldt vann.
 - 2 Utstrømningsbatteri ***
Kobles til det andre blandebatteri. Forbinder også alle dyser for utstrømningsbatteri.
 - 3 Kran ***
Kraner eller foss. Aktiveres ved utstrømningsbatteri.
 - 4 Håndholdt dusj ***
Kan løftes fra festet. Aktiveres ved utstrømningsbatteri.
-  **Tilkobling (varmt vann)**
Maks trykk ≥ 0.23 MPa. Maks temperatur (blandet flyt) 60°C.
-  **Tilkobling (kaldt vann)**
Maks trykk ≥ 0.23 MPa. Maks temperatur (blandet flyt) 60°C.
-  **Kvalifisert?**
All installasjon skal ALLTID utføres av kvalifiserte håndverkere.
-  **Pass på lekkende koblinger**
REPARER lekkasjer og andre skader på rør og slangar umiddelbart når detektert.

* Kraner, blandebatterihoder og dyser kan variere mellom ulike versjoner av produktet. Installasjonsprosessen er imidlertid den samme for alle varianter.





VESI (JATKUI)

- 1 Yhden kädensijan mikseri ***
Liittyy ulosvirtausmikserin. Tulossa oleva kylmä ja kuuma vesi yhdistävät myös tänne.
 - 2 Ulosvirtausmikserin ***
Liittyy yhden kädensijan mikseri. Kaikki suuttimet yhdistävät myös tänne.
 - 3 Hana ***
Hana tai vesiputous. Aktivoituna kanssa ulosvirtausmikseri.
 - 4 Käsisuihku ***
Nostettava ulos kannatin. Aktivoituna kanssa ulosvirtausmikserin.
-  **Kuumavesitilo**
Maksimipaine ≥ 0.23 MPa. Maksimilämpötila (sekoitettu virtaus) 60°C.
-  **Kylmävesitilo**
Maksimipaine ≥ 0.23 MPa. Maksimilämpötila (sekoitettu virtaus) 60°C.
-  **Pätevä?**
AINA palkata lisensoitu ammattilainen suorittamaan asennus.
-  **Varokaa vuotavat liitännät**
KORJAA vuotoja ja muita asioita putkista ja putkista välittömästi havaitessaan.

* Hanat, mikseri päät ja suuttimet voivat vaihdella eri versioiden välillä. Asennus on kuitenkin sama kaikissa versioissa.



WATER (CONT.)

- 1 Single grip mixer ***
Connects to the outflow mixer. Incoming cold and hot water also connects here.
 - 2 Outflow mixer ***
Connects to the single grip mixer. All nozzles (such as the tap) also connect here.
 - 3 Tap ***
Tap or waterfall. Activated using the outflow mixer.
 - 4 Handheld shower ***
Can be lifted from its mount. Activated using the outflow mixer.
-  **Hot water inlet**
Max pressure ≥ 0.23 MPa. Max temperature (mixed flow) 60°C.
-  **Cold water inlet**
Max pressure ≥ 0.23 MPa. Max temperature (mixed flow) 60°C.
-  **Certificated?**
Work should ALWAYS be carried out by a certificated professional.
-  **Beware leaking couplings**
REPAIR leaks and other issues in pipes and hoses immediately when discovered.

* Taps, mixer heads and nozzles may vary between different versions of the product. However, the installation procedure remains the same for all versions.



Copyright ©2017 Bygghemma Sverige AB. All rights reserved. Bygghemma Group Nordic AB is the registered holder of the bathlife® logo.



Information contained within this document was considered accurate at the time of publication, but may be subject to revision.



Some colours are based on the PANTONE® Colour Matching System. Colours may present differently in digital and physical formats.



VATTEN (FORTS.)

**TVÅGREPPSBLANDARE**

Följ denna guide om karet har tvågreppsblandare. Lokala lagar och föreskrifter går före manualen.



VANN (FORTS.)

**TOGREPPSBATTERI**

Følg denne veiledningen på karet har togreppsbatteri. Lokale lover og forskrifter kommer før boken.



VESI (JATKUI)

**KAKSI KÄDENSIJAN MIKSERI**

Seuraa, jos ammeessa on kaksi kädensijan mikseri. Paikallisia lakeja ja säädöksiä etusijalla.



WATER (CONT.)

**DUAL GRIP MIXER**

Follow this guide is the tub has a dual grip mixer. Local laws and regulations supersede the manual.



VITAL ✗ ECO ✓ PLUS ✓

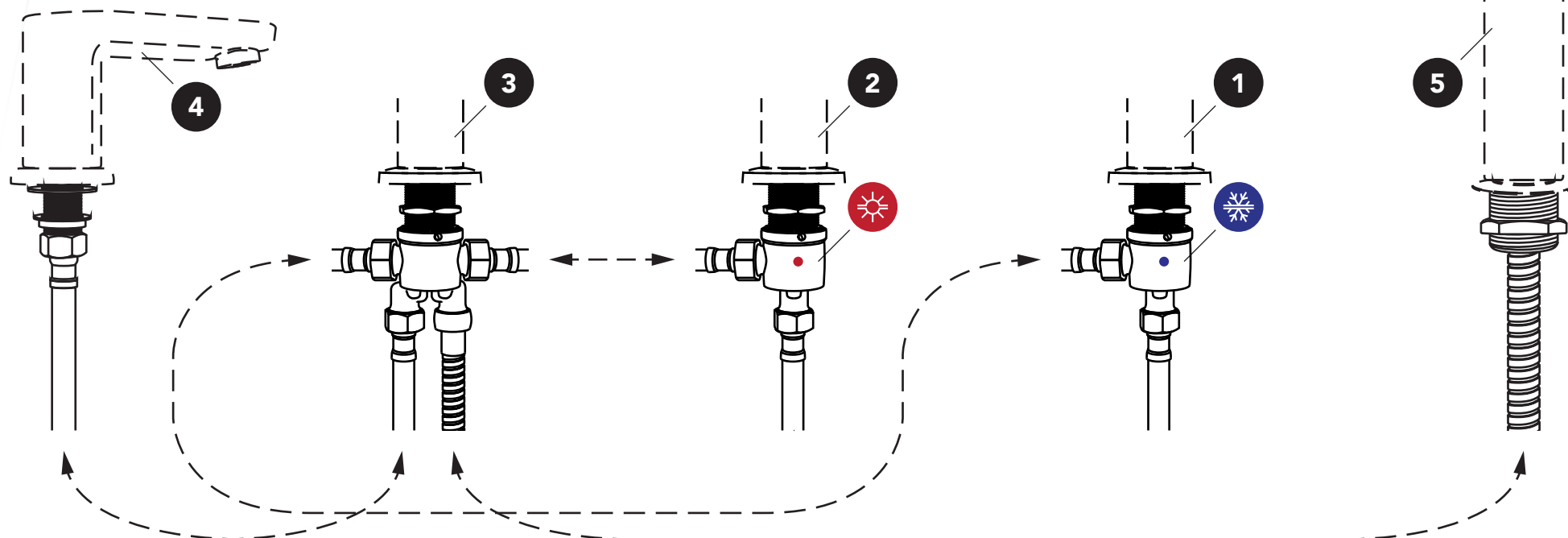

Copyright ©2017 Bygghemma Sverige AB. All rights reserved. Bygghemma Group Nordic AB is the registered holder of the bathlife® logo.



Information contained within this document was considered accurate at the time of publication, but may be subject to revision.



Some colours are based on the PANTONE® Colour Matching System. Colours may present differently in digital and physical formats.

emv_bathtub_connections

v1.2



VATTEN (FORTS.)

- 1 Tvågreppsblandare (kallv.) ***
Kopplas samman med utflödesblandaren. Här ansluts inkommande kallvatten.
 - 2 Tvågreppsblandare (varmv.) ***
Kopplas samman med utflödesblandaren. Här ansluts inkommande varmvatten.
 - 3 Utflödesblandare ***
Kopplas samman med engreppsblandaren. Här ansluts även alla munstycken.
 - 4 Kran ***
Tappkran eller vattenfall. Aktiveras med hjälp av utflödesblandaren.
 - 5 Dusch, handhållen ***
Kan lyftas ur sitt fäste. Aktiveras med hjälp av utflödesblandaren.
-  **Varmvattenanslutning**
Maxtryck ≥ 0.23 MPa. Maxtemp. (blandat flöde) 60°C. ½"-koppling.
-  **Kallvattenanslutning**
Maxtryck ≥ 0.23 MPa. Maxtemp. (blandat flöde) 60°C. ½"-koppling.
-  **Behörig?**
Installation skall ALLTID utföras av behörig hantverkare.
-  **Se upp för läckande kopplingar**
REPARERA läckor och andra skador i rör och slangar omedelbart när de upptäcks.

* Kranar, blandarhuvuden och munstycken kan variera mellan olika varianter av produkten. Installationsförfarandet är dock detsamma för alla varianter.





VANN (FORTS.)

- 1 Togreppsbatteri (kaldt vann) ***
Kobles til utstrømningsbatteri. Her kobles også den innkommende kaldt vann.
 - 2 Togreppsbatteri (varmt vann) ***
Kobles til utstrømningsbatteri. Her kobles også den innkommende varmt vann.
 - 3 Utstrømningsbatteri ***
Kobles til det andre blande-batteri. Forbinder også alle dyser for utstrømningen.
 - 4 Kran ***
Kraner eller foss. Aktiveres ved utstrømningsbatteri.
 - 5 Håndholdt dusj ***
Kan løftes fra festet. Aktiveres ved utstrømningsbatteri.
-  **Tilkobling (varmt vann)**
Maks trykk ≥ 0.23 MPa. Maks temperatur (blandet flyt) 60°C.
-  **Tilkobling (kaldt vann)**
Maks trykk ≥ 0.23 MPa. Maks temperatur (blandet flyt) 60°C.
-  **Kvalifisert?**
All installasjon skal ALLTID utføres av kvalifiserte håndverkere.
-  **Pass på lekkende koblinger**
REPARER lekkasjer og andre skader på rør og slangar umiddelbart når detektert.

* Kraner, blande-batterihoder og dyser kan variere mellom ulike versjoner av produktet. Installasjonsprosessen er imidlertid den samme for alle varianter.





VESI (JATKUI)

- 1 Kaksi kädensijan mikseri (ky. v.) ***
Liittyy ulosvirtausmikserin. Tulossa oleva kylmä vesi yhdistävät myös tänne.
 - 2 Kaksi kädensijan mikseri (ku. v.) ***
Liittyy ulosvirtausmikserin. Tulossa oleva kuuma vesi yhdistävät myös tänne.
 - 3 Ulosvirtausmikserin ***
Liittyy yhden kädensijan mikseri. Kaikki suuttimet yhdistävät myös tänne.
 - 4 Hana ***
Hana tai vesiputous. Aktivoituna kanssa ulosvirtausmikseri.
 - 5 Käsisuihku ***
Nostettava ulos kannatin. Aktivoituna kanssa ulosvirtausmikserin.
-  **Kuumavesitilo**
Maksimipaine ≥ 0.23 MPa. Maksimilämpötila (sekoitettu virtaus) 60°C.
-  **Kylmävesitilo**
Maksimipaine ≥ 0.23 MPa. Maksimilämpötila (sekoitettu virtaus) 60°C.
-  **Pätevä?**
AINA palkata lisensoitu ammattilainen suorittamaan asennus.
-  **Varokaa vuotavat liitännät**
KORJAA vuotoja ja muita asioita putkista välittömästi havaitessaan.

* Hana, mikseri päät ja suuttimet voivat vaihdella eri versioiden välillä. Asennus on kuitenkin sama kaikissa versioissa.



WATER (CONT.)

- 1 Dual grip mixer (cold water) ***
Connects to the outflow mixer. Incoming cold water also connects here.
 - 2 Dual grip mixer (hot water) ***
Connects to the outflow mixer. Incoming hot water also connects here.
 - 3 Outflow mixer ***
Connects to the single grip mixer. All nozzles (such as the tap) also connect here.
 - 4 Tap ***
Tap or waterfall. Activated using the outflow mixer.
 - 5 Handheld shower ***
Can be lifted from its mount. Activated using the outflow mixer.
-  **Hot water inlet**
Max pressure ≥ 0.23 MPa. Max temperature (mixed flow) 60°C.
-  **Cold water inlet**
Max pressure ≥ 0.23 MPa. Max temperature (mixed flow) 60°C.
-  **Certificated?**
Work should ALWAYS be carried out by a certificated professional.
-  **Beware leaking couplings**
REPAIR leaks and other issues in pipes and hoses immediately when discovered.

* Taps, mixer heads and nozzles may vary between different versions of the product. However, the installation procedure remains the same for all versions.



Copyright ©2017 Bygghemma Sverige AB. All rights reserved. Bygghemma Group Nordic AB is the registered holder of the bathlife® logo.



Information contained within this document was considered accurate at the time of publication, but may be subject to revision.



Some colours are based on the PANTONE® Colour Matching System. Colours may present differently in digital and physical formats.

emv_bathtub_connections

v1.2

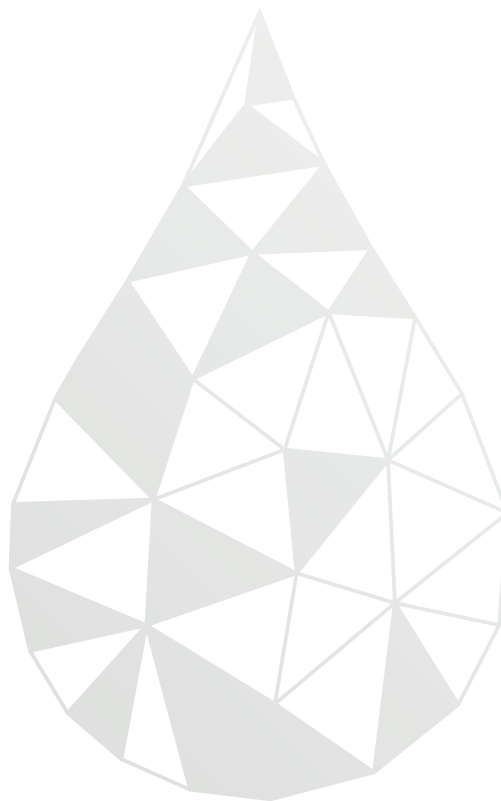

Copyright ©2017 Bygghemma Sverige AB. All rights reserved. Bygghemma Group Nordic AB is the registered holder of the bathlife® logo.



Information contained within this document was considered accurate at the time of publication, but may be subject to revision.



Some colours are based on the PANTONE® Colour Matching System. Colours may present differently in digital and physical formats.

emv_bathtub_connections

v1.2