

VIGHET



EN 60335-1:2008+A11:2014 (15)

EN 60335-2-35:2002+A2:2011 (15)

EN 60335-2-41+A2:2010 (15)

EN 62233:2008 (15)

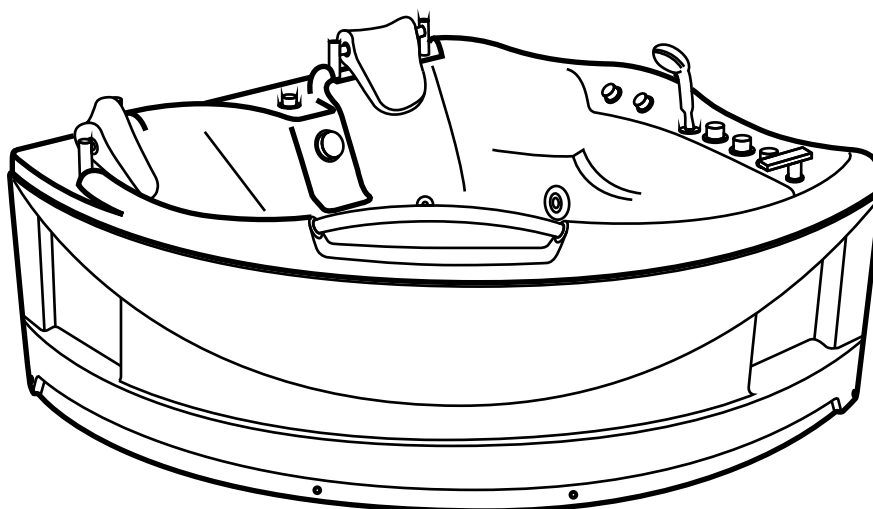

bathlife[®]

OF SWEDEN

© 2016

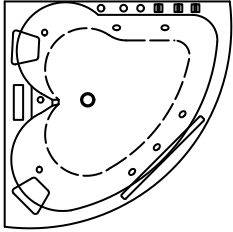

x1

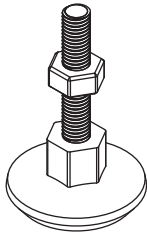

x6

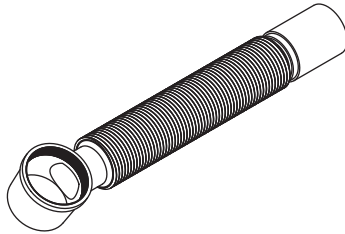

x1

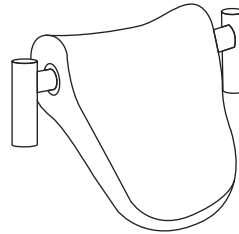

x2

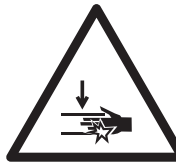
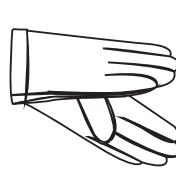
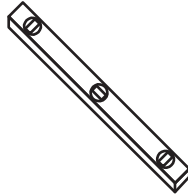
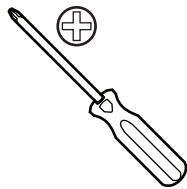



220V AC

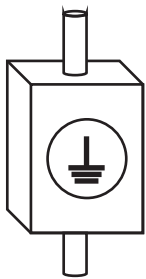
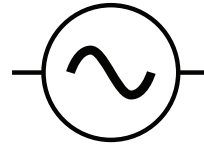

GFCI/RCD
MAX 30mA



750W

ECO ✓ PLUS ✓



1500W

ECO ✗ PLUS ✓

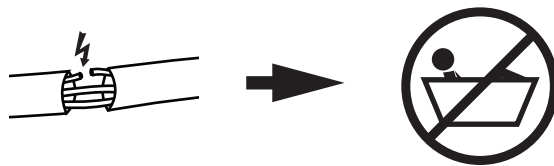
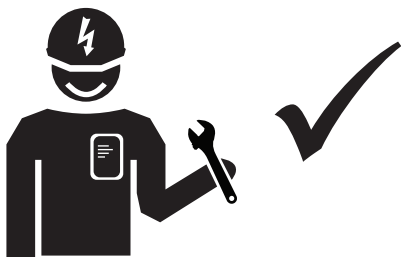



$\geq 0,23$ MPa

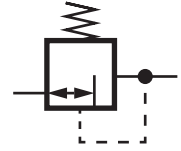

MAX 60°C

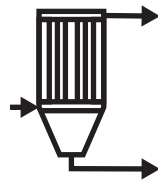
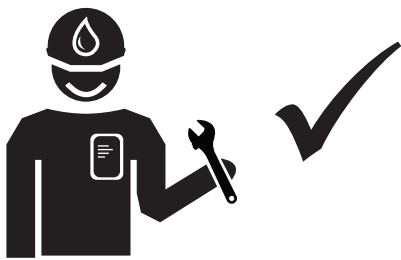
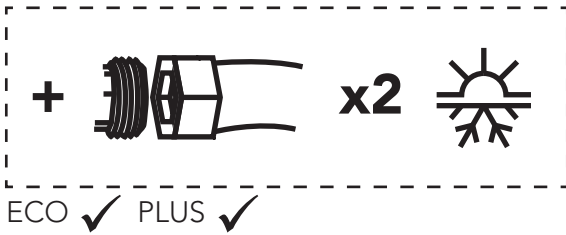

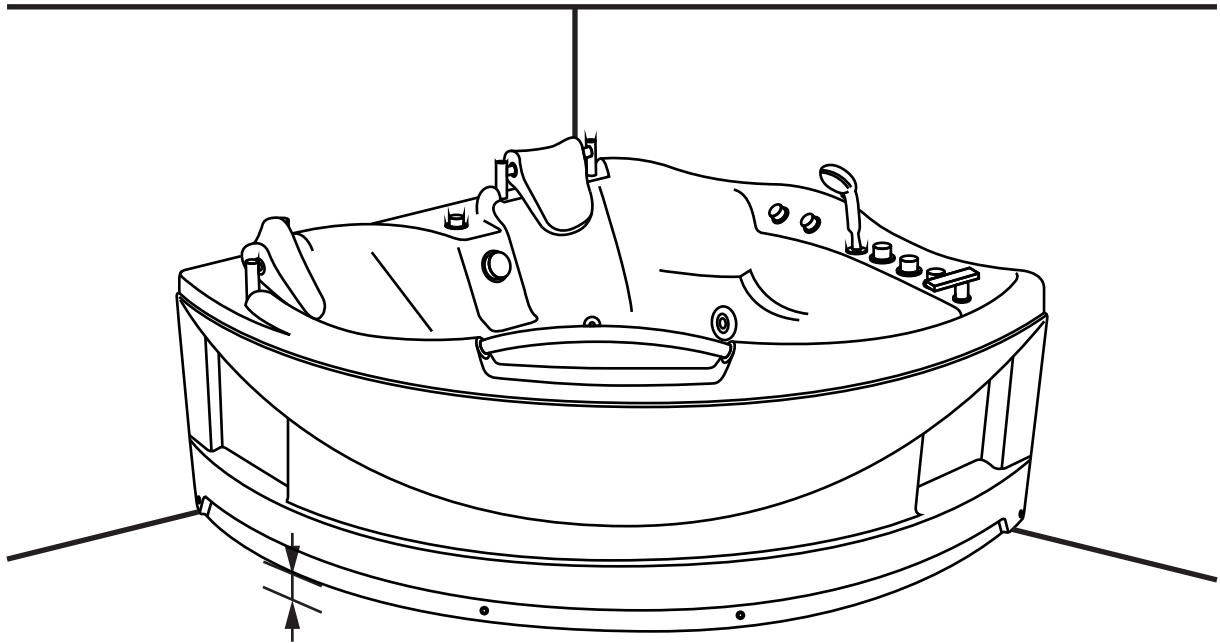
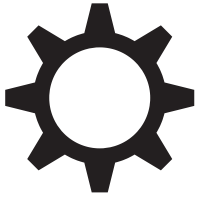

MIN 10 mm

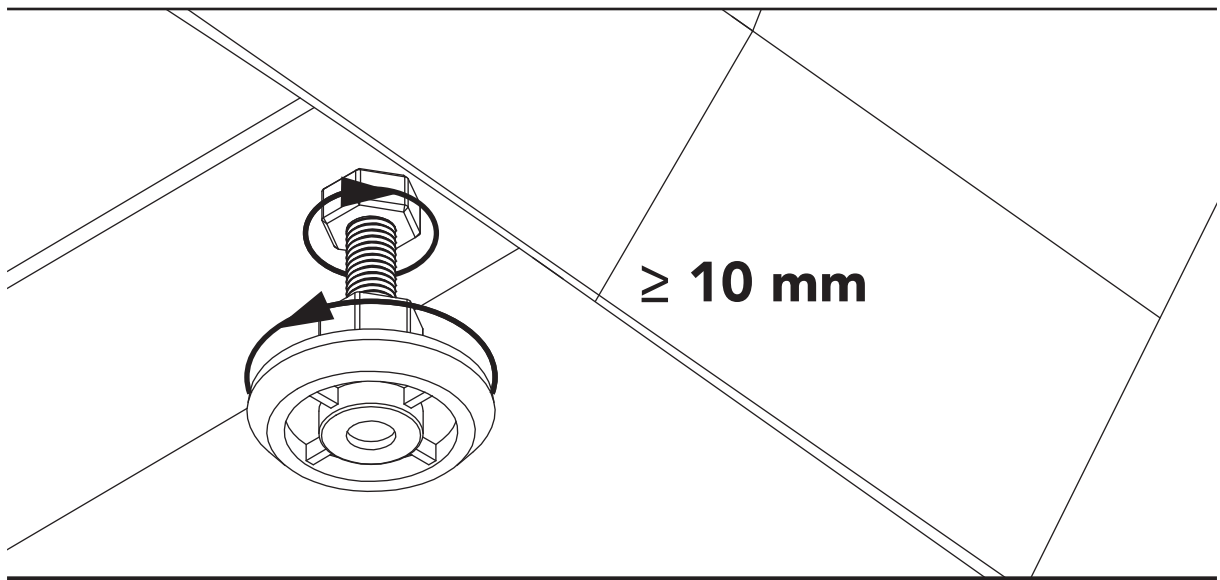

≥ 10 mm

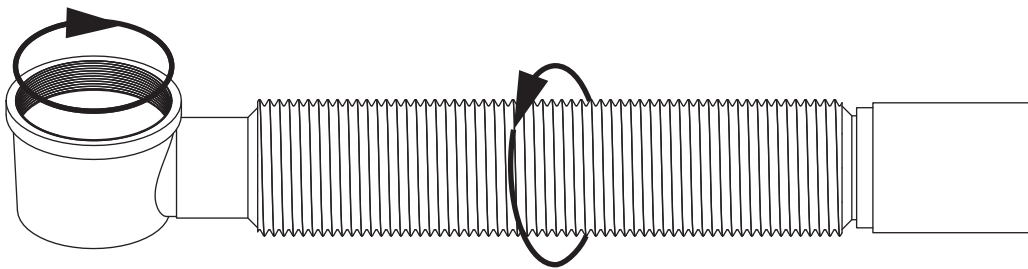
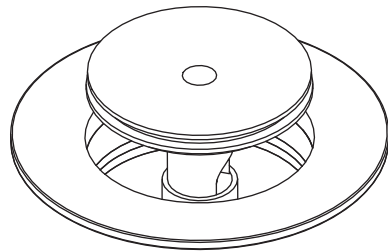
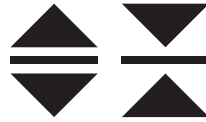
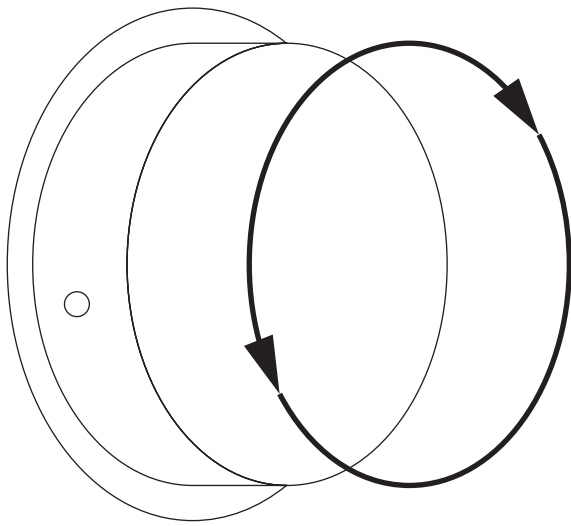

160 - 700 mm

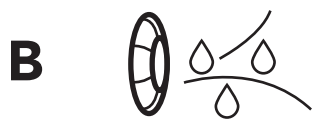
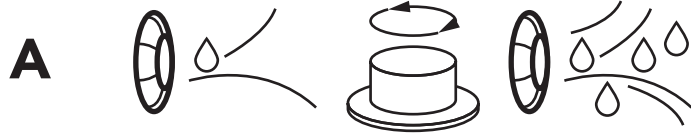
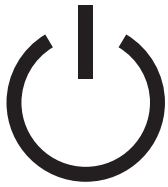

ECO ✗ PLUS ✓

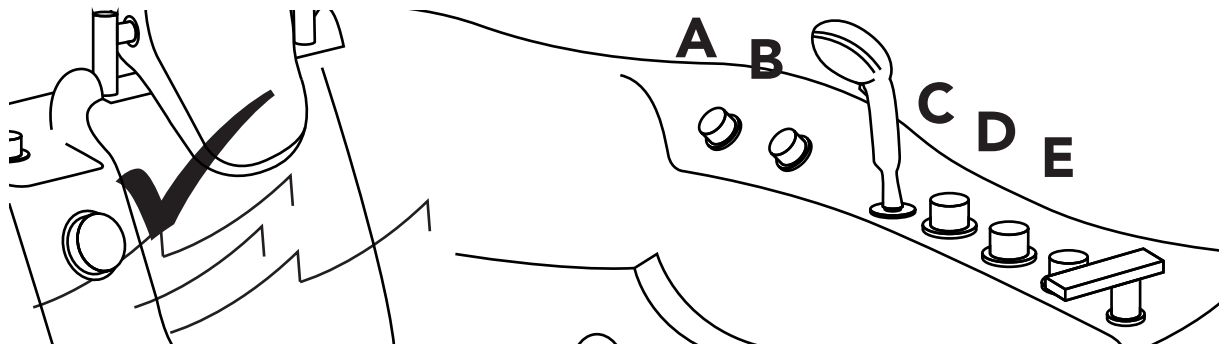
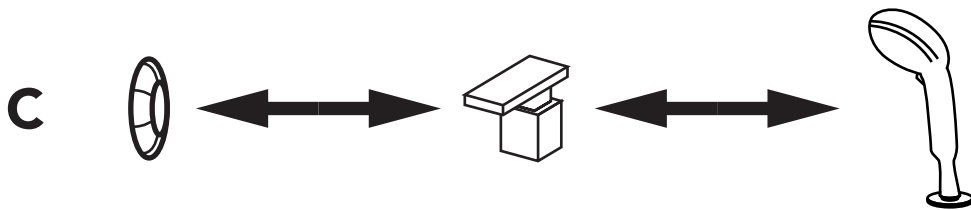
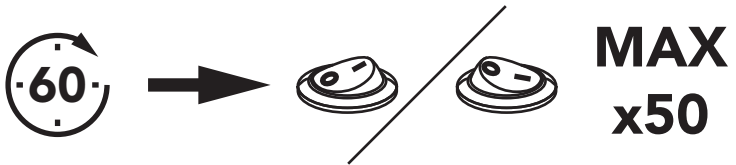



Never use chemicals with bleaching or abrasive properties.
Använd aldrig kemikalier med blekande eller slipande egenskaper.
Bruk aldri kjemikalier med blegning eller slipende egenskaper.
Brug aldrig kemikalier med blegemiddel eller slibende egenskaber.
Älä koskaan käytä kemikaaleja valkaisevaa tai hankaavia ominaisuuksia.
Verwenden sie niemals chemikalien mit bleichmittel oder abrasiven eigenschaften.

