

# PUSTA

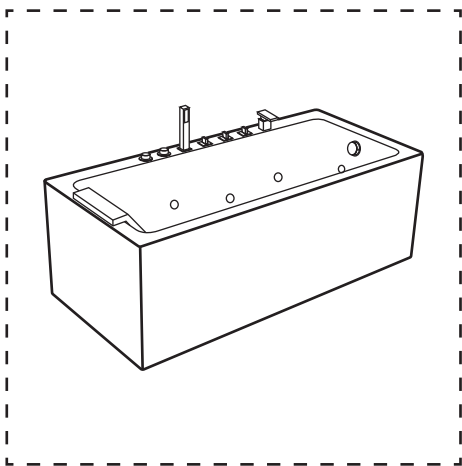

CE EN 14516:2006+A1:2010

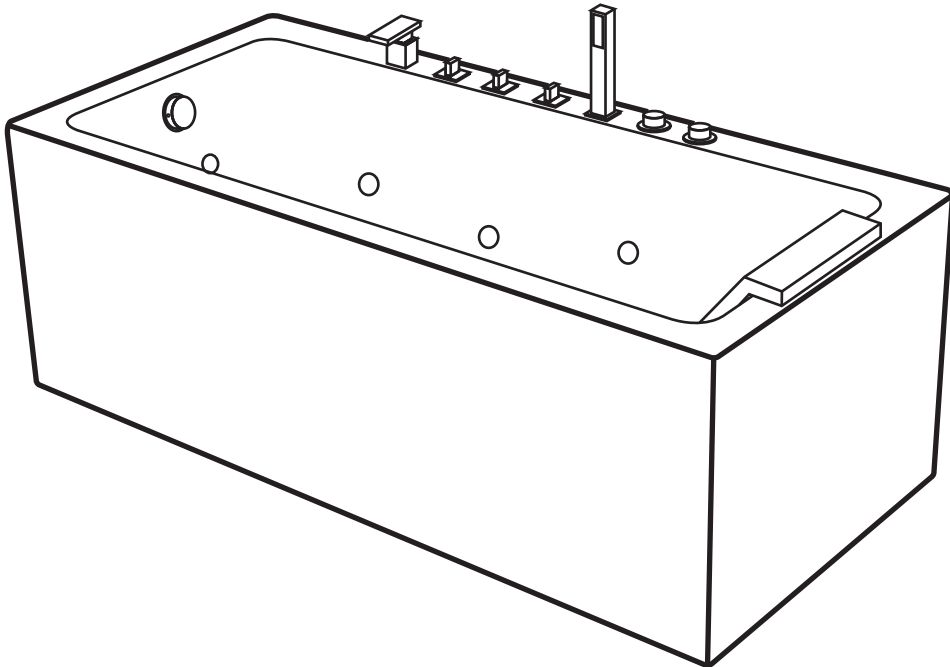

bathlife<sup>®</sup>

OF SWEDEN

© 2016

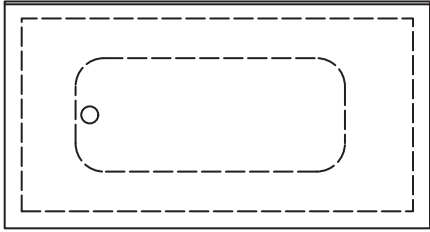

x1

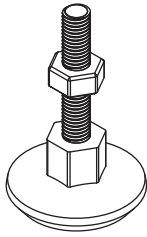

x6

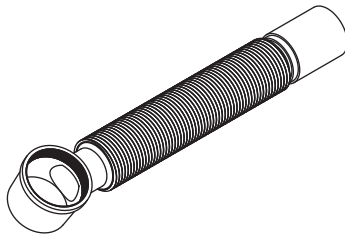

x1

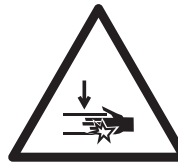
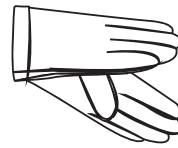
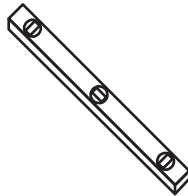
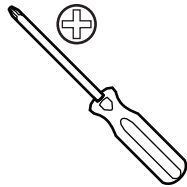



VITAL ✗ ECO ✓ PLUS ✓

---

220V AC

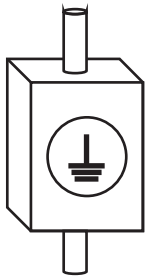
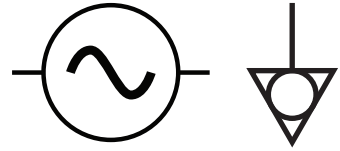

**GFCI/RCD**  
MAX 30mA

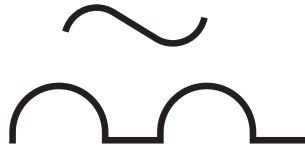

+ **750W**

VITAL ✗ ECO ✓ PLUS ✓



+ **1500W**

VITAL ✗ ECO ✗ PLUS ✓

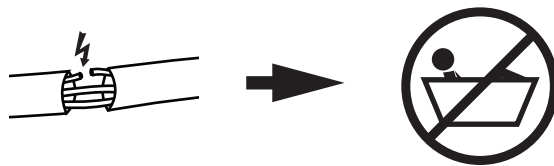
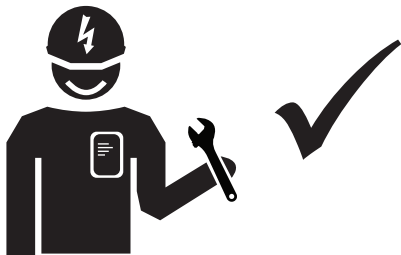



VITAL ✗ ECO ✓ PLUS ✓

---

$\geq 0,23$  MPa

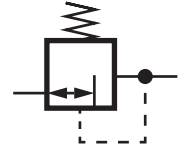

MAX 60°C

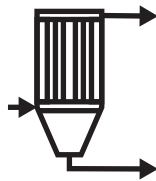
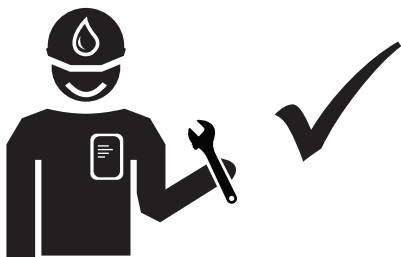
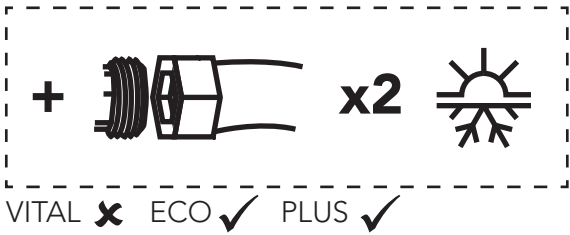

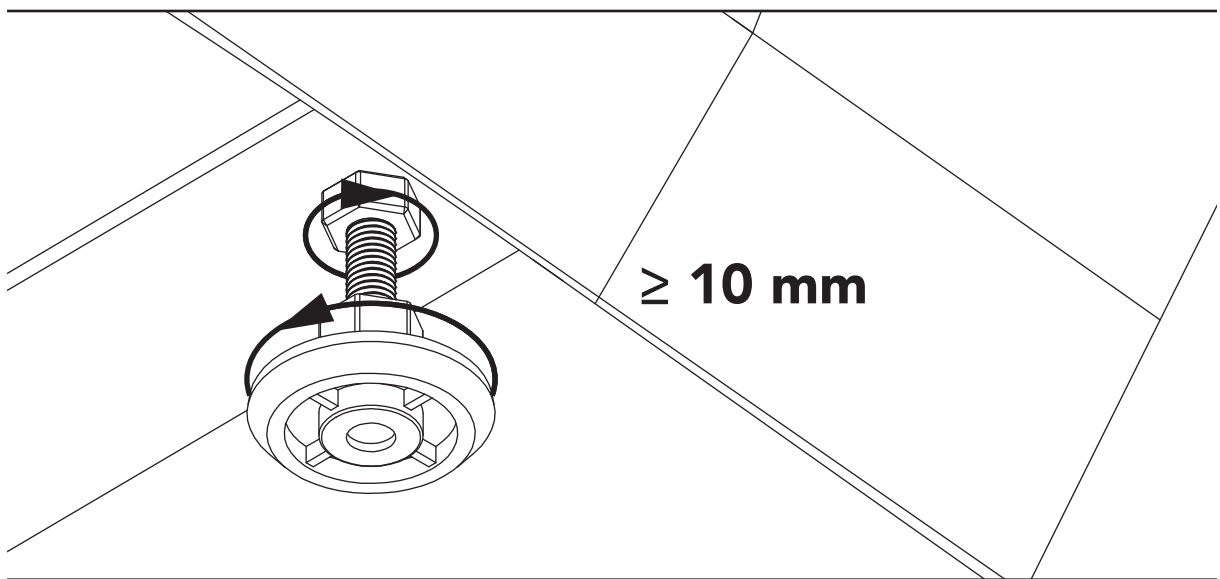
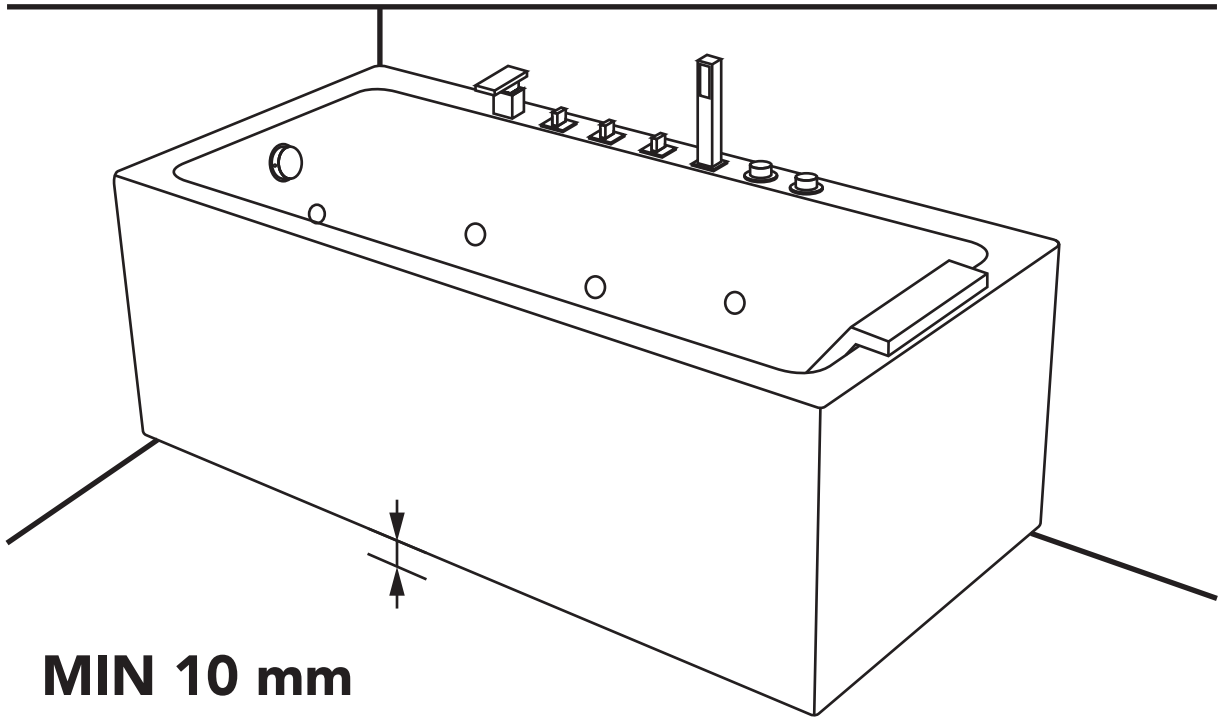
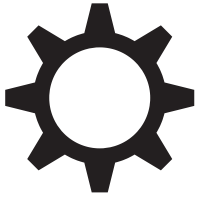

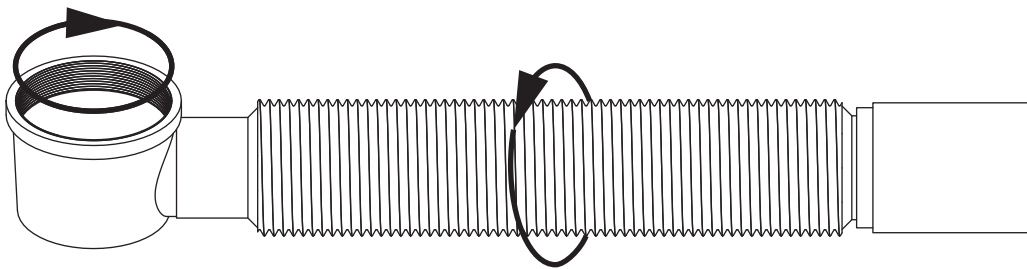
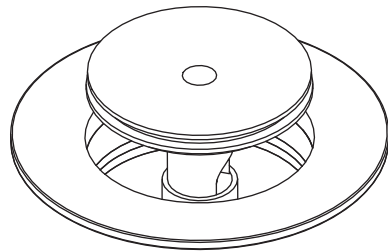
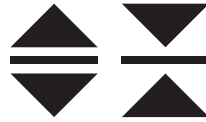
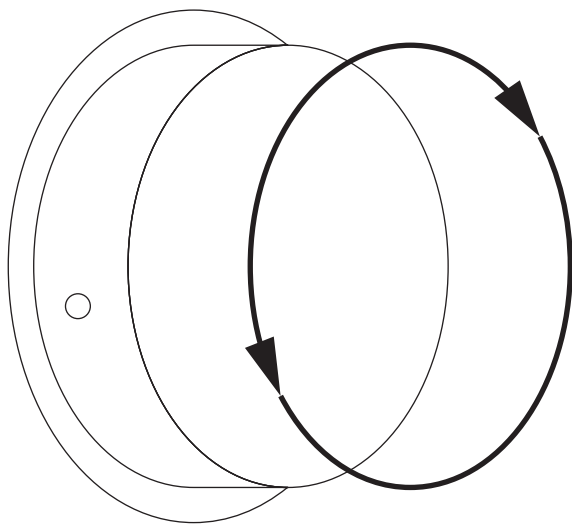
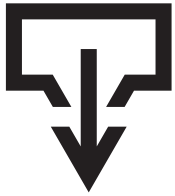

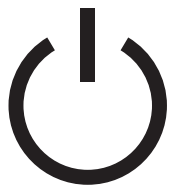

**160 - 700 mm**



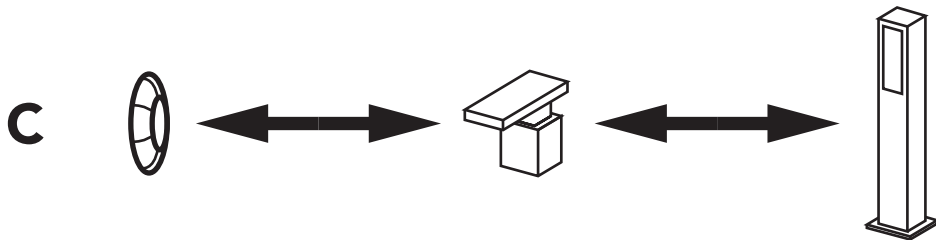

VITAL ✗ ECO ✓ PLUS ✓





A/B  



D  

 **AUTO ≈ 40°C**  
 VITAL ✗ ECO ✗ PLUS ✓

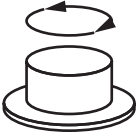
 →  **MAX x50**

E     

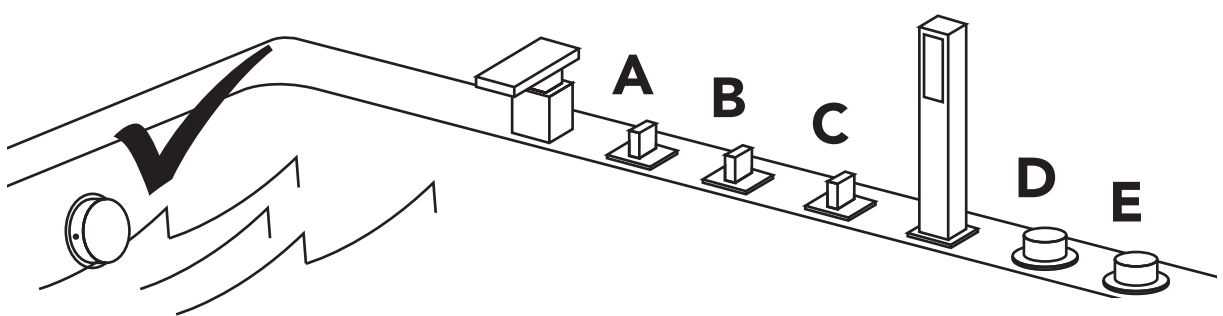



Never use chemicals with bleaching or abrasive properties.  
Använd aldrig kemikalier med blekande eller slipande egenskaper.  
Bruk aldri kjemikalier med blegning eller slipende egenskaper.  
Brug aldrig kemikalier med blegemiddel eller slibende egenskaber.  
Älä koskaan käytä kemikaaleja valkaisevaa tai hankaavia ominaisuuksia.  
Verwenden sie niemals chemikalien mit bleichmittel oder abrasiven eigenschaften.

