

9015B
90*90*200/80*80*200cm

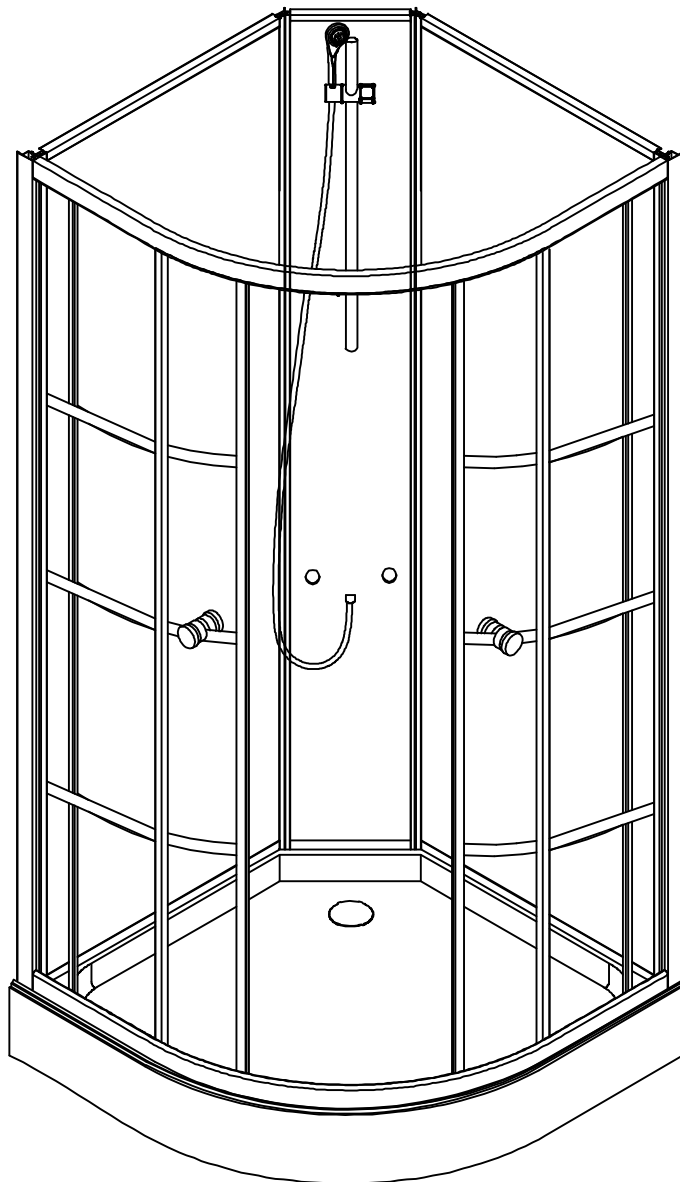

bathlife®
OF SWEDEN

Install Manual



REMARK:

- 1: At least two people installed this shower cabin**
- 2: The four corners of the tempered glass are very fragile and must be protected when installed.**



Copyright ©2016 Bygghemma Sverige AB. The bathlife® logo is a registered trademark of Bygghemma Sverige AB. All rights reserved.



This artwork is presented as-is, is a work in progress concept and does not represent the quality or function of a final product.



Some colours are based on the PANTONE® Colour Matching System. Colours may display differently in digital and final products.



MAINTENANCE

CLEANING

- Clean regularly with a mixture of equal parts of water and vinegar. Allow 5 minutes for it to act, and then rinse with water.
- Do not use strong or abrasive detergents or solvents, this could damage the product.
 - Follow the manufacturer's instructions when using detergents. Do not use steel wool/Scotchbrite, abrasive detergents or sharp implements.
- Use bactericidal detergent on a regular basis.
- Leave the doors open after using the shower to reduce the risk of mildew.
- Rinse off residual soap etc. from the walls after use.

MAINTENANCE

- Lubricate the doors if they make a noise, or do not open and close smoothly.
- Check that all parts are correctly fitted and sealed before using the shower.
- Check that the walls are vertical and correctly fitted to each other before use.

TROUBLESHOOTING

Problem	Action
Leakage	Check the watertightness between the base and the glass walls.
	Check the watertightness between the base and the rails.
	Check the watertightness between the rails and the glass walls.
Walls do not fit properly to the base	Check with a spirit level that the base is horizontal.
	Check with a spirit level that the walls are vertical.
Doors make a noise and/or do not open and close smoothly	Check with a spirit level that the shower cabinet is fastened vertically to the wall.
	Check door wheels and their lubrication.



bathlife®
OF SWEDEN



UNDERHÅLL

RENGÖRING

- Rengör regelbundet med en blandning av lika delar vatten och ättika. Låt verka 5 minuter och skölj med vatten
- Använd inte starka eller slipande rengöringsmedel eller lösningsmedel, det kan skada produkten.
 - Följ tillverkarens anvisningar vid användning av rengöringsmedel. Använd inte stålull/scotchbrite, slipande rengöringsmedel eller vassa föremål.
- Använd regelbundet bakteriedödande rengöringsmedel.
- Låt dörrarna stå öppna efter att duschen har använts, för att minska risken för uppkomst av mögel.
- Spola bort tvålrester och liknande från väggarna efter varje användning.

UNDERHÅLL

- Smörj om dörrarna bullrar eller rör sig ojämnt.
- Kontrollera att alla delar är korrekt monterade och tätade innan du använder vatten.
- Kontrollera före användning att väggarna är vertikala och korrekt inpassade mot varandra.

FELSÖKNING

Problem	Åtgärd
Läckage	Kontrollera vattentätheten mellan botten och glasväggar.
	Kontrollera vattentätheten mellan botten och skenor.
	Kontrollera vattentätheten mellan skenor och glasväggar.
Väggar inte inpassade mot botten	Kontrollera med vattenpass att botten är horisontell.
	Kontrollera med vattenpass att väggarna är vertikala.
Dörrarna bullrar och/eller rör sig ojämnt	Kontrollera med vattenpass att duschkabinen är vertikalt infäst mot väggen.
	Kontrollera dörrarnas hjul och deras smörjning.



bathlife[®]
OF SWEDEN



VEDLIKEHOLD

RENGJØRING

- Rengjør regelmessig med en blanding av like deler vann og eddik. La virke i 5 minutter og skyll med vann
- Ikke bruk sterke eller slipende rengjøringsmidler eller løsemidler, det kan skade produktet.
 - Følg produsentens anvisninger ved bruk av rengjøringsmiddel. Ikke bruk stålull/scotchbrite, slipende rengjøringsmidler eller skarpe gjenstander.
- Bruk regelmessig bakteriedrepende rengjøringsmiddel.
- La dørene stå åpne etter at dusjen er brukt, for å redusere faren for at det danner seg mugg.
- Skyll bort såperester og lignende fra veggene etter hver gangs bruk.

VEDLIKEHOLD

- Smør hvis dørene støyer og/eller beveger seg ujevnt.
- Kontroller at alle deler er riktig montert og tett før du bruker vann.
- Kontroller før bruk at veggene er vertikale og korrekt tilpasset mot hverandre.

FEILSØKING

Problem	Tiltak
Lekkasje	Kontroller vanntettheten mellom bunnen og glassvegger.
	Kontroller vanntettheten mellom bunnen og skinner.
	Kontroller vanntettheten mellom skinner og glassvegger.
Vegger ikke rettet inn mot bunnen	Kontroller med vaterpass at bunnen er horisontal.
	Kontroller med vaterpass at veggene er vertikale.
Dørene støyer og/eller beveger seg ujevnt	Kontroller med vaterpass at dusjkabinettet er vertikalt festet mot veggene.
	Kontroller hjulene på dørene og om de er smurt.



bathlife®
OF SWEDEN

Produkt oversikt

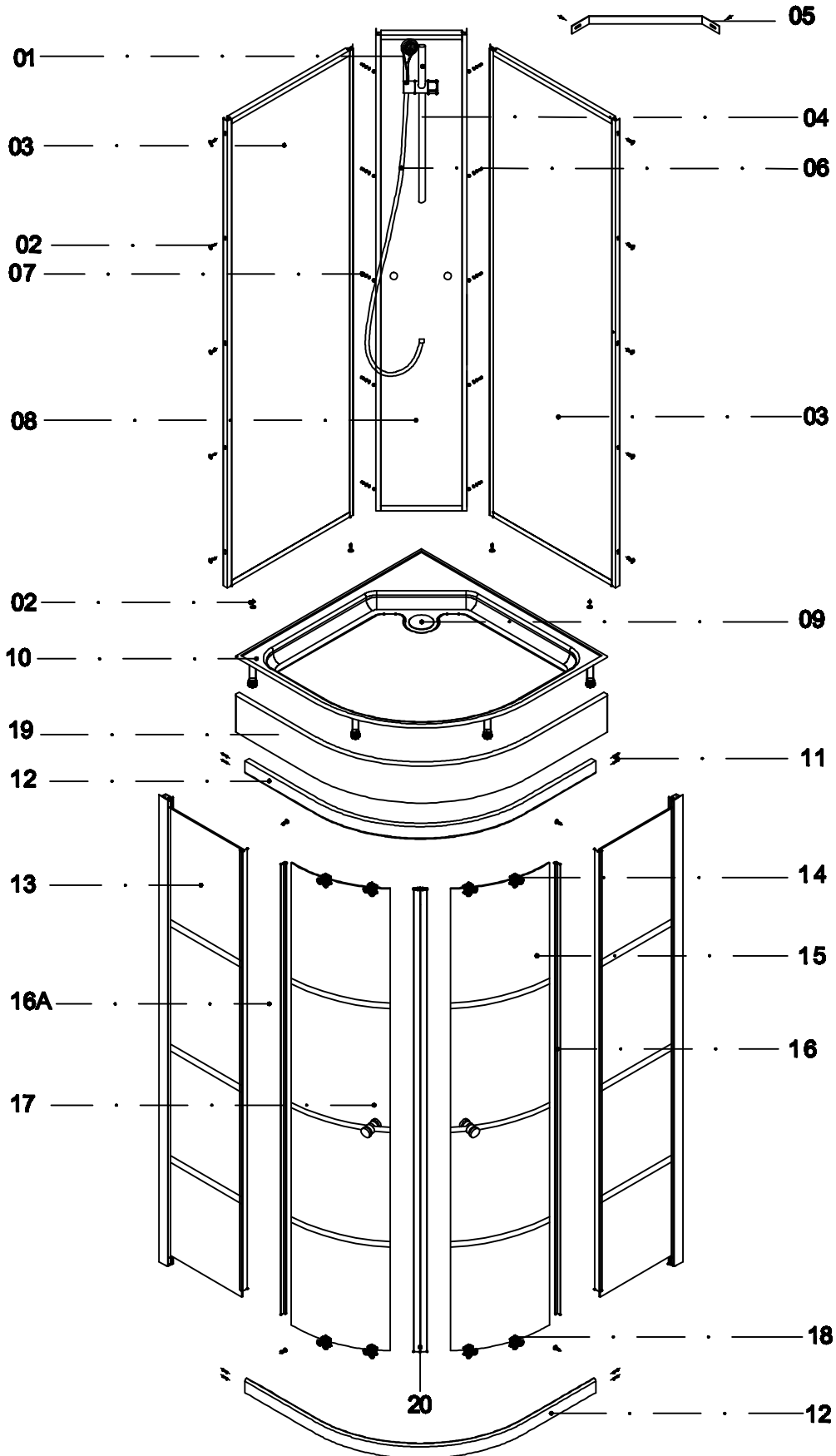



bathlife®
OF SWEDEN

Tilbehør

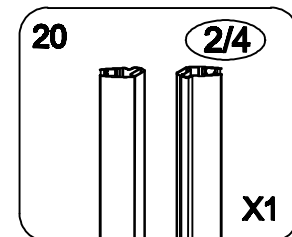
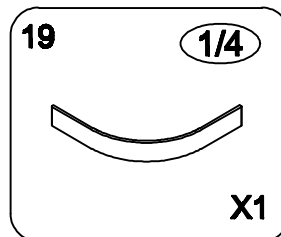
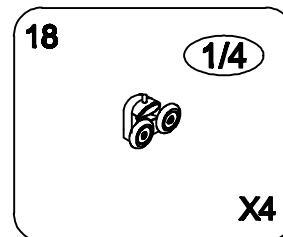
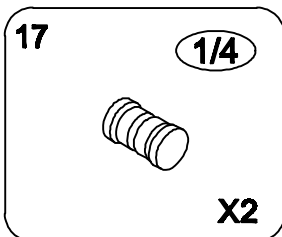
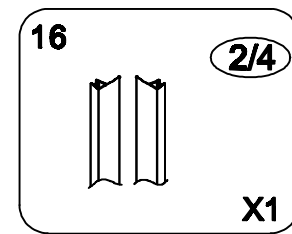
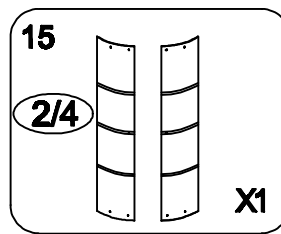
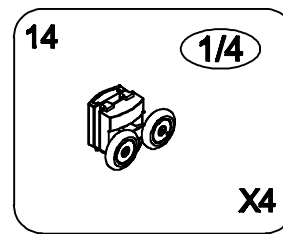
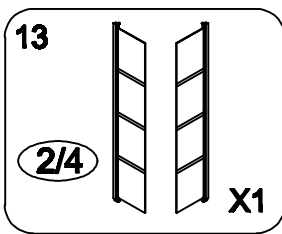
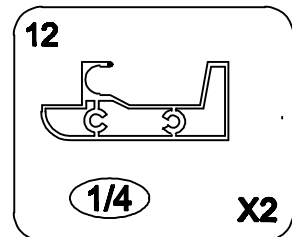
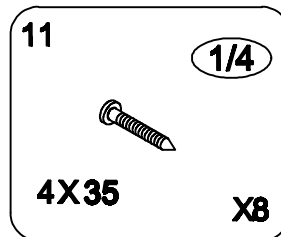
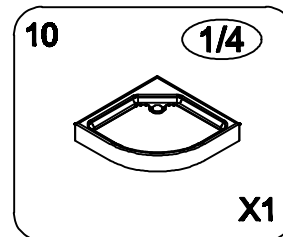
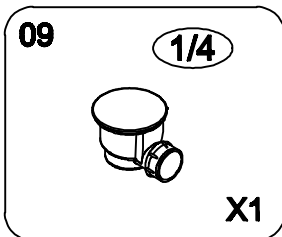
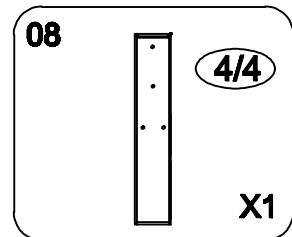
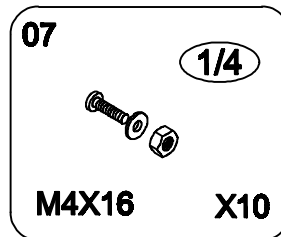
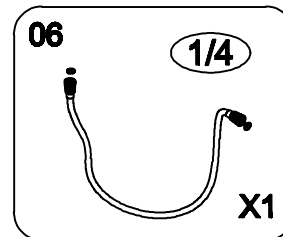
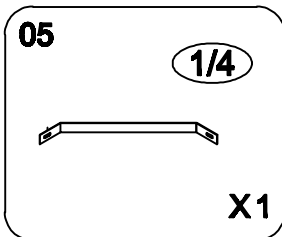
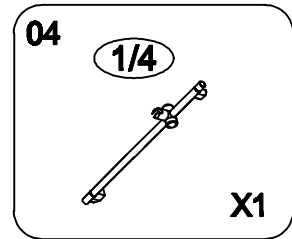
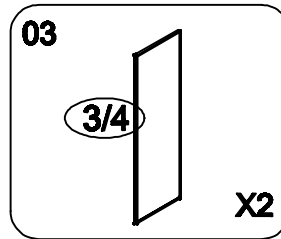
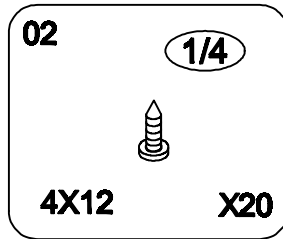
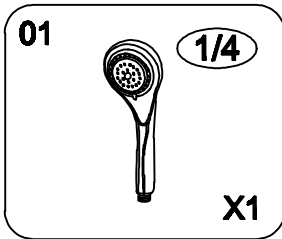

1/4: Tray
2/4: Font glass
3/4: Back glass
4/4: Shower panel

1: After opening the package, please check carefully whether the accessories are complete.

2: Properly take care of all the accessories. During installation, each accessory will be used.



bathlife®

OF SWEDEN

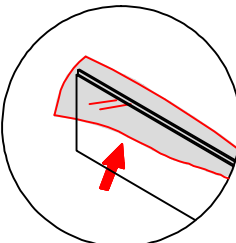
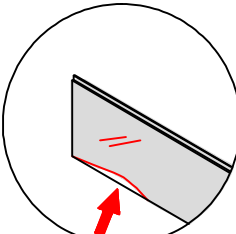
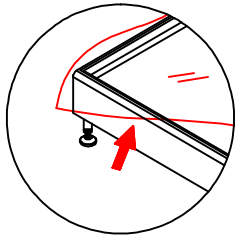
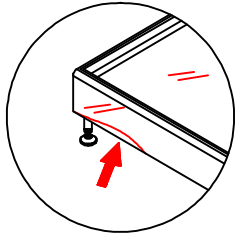
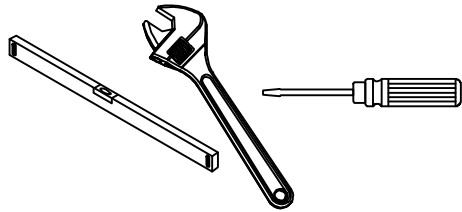
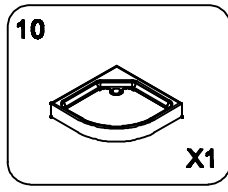
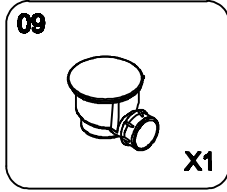

10

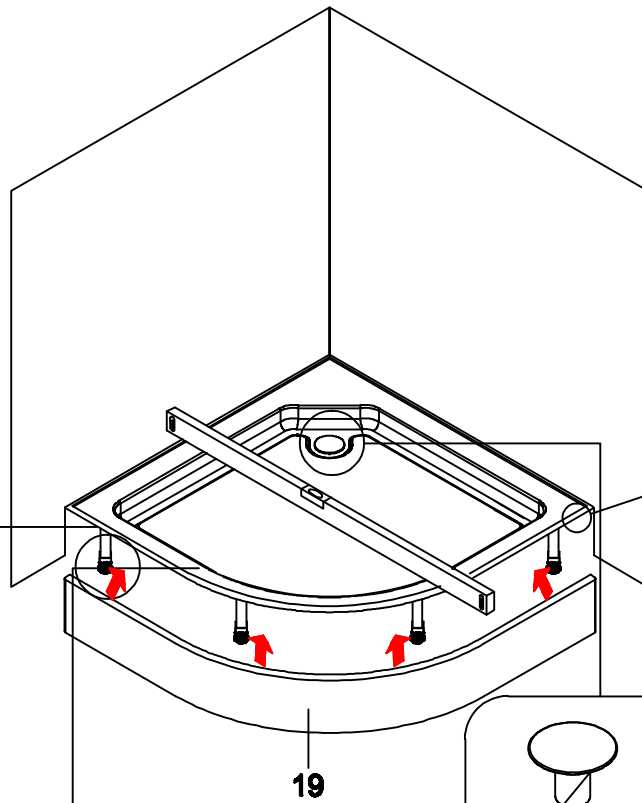

19

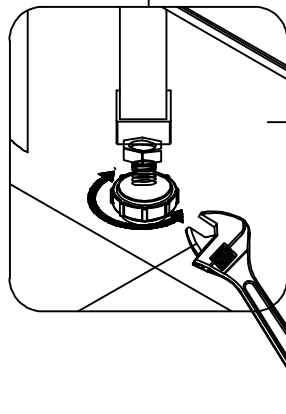

10
09

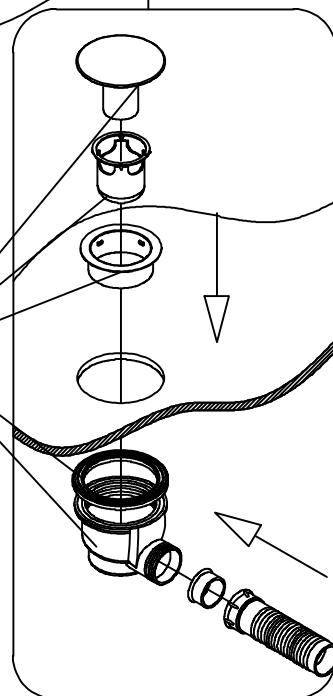



bathlife®
OF SWEDEN

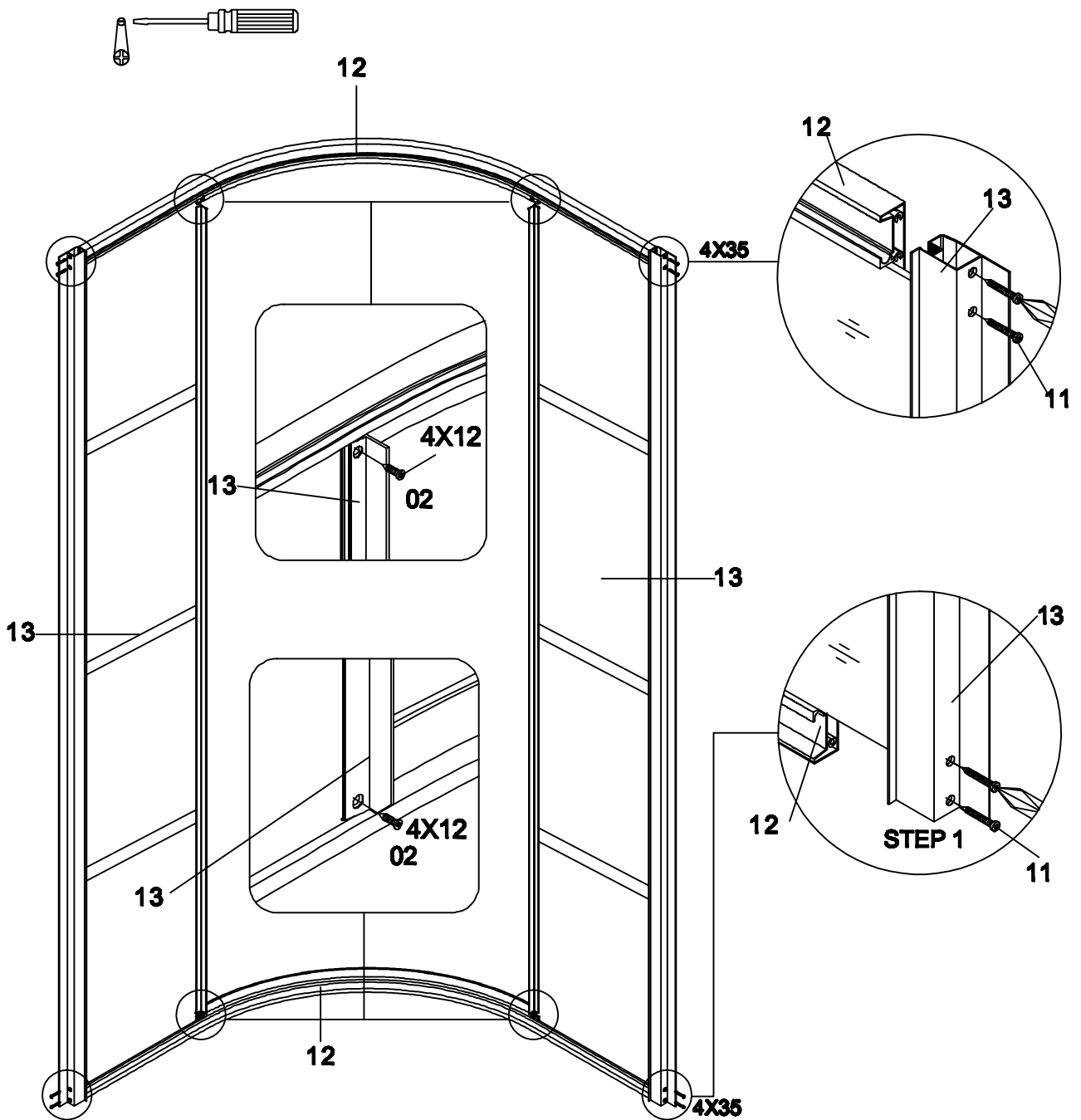
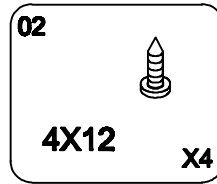
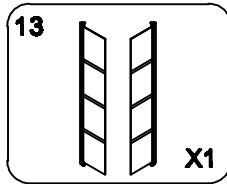
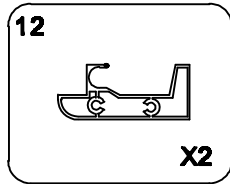
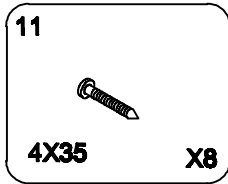



bathlife®

OF SWEDEN

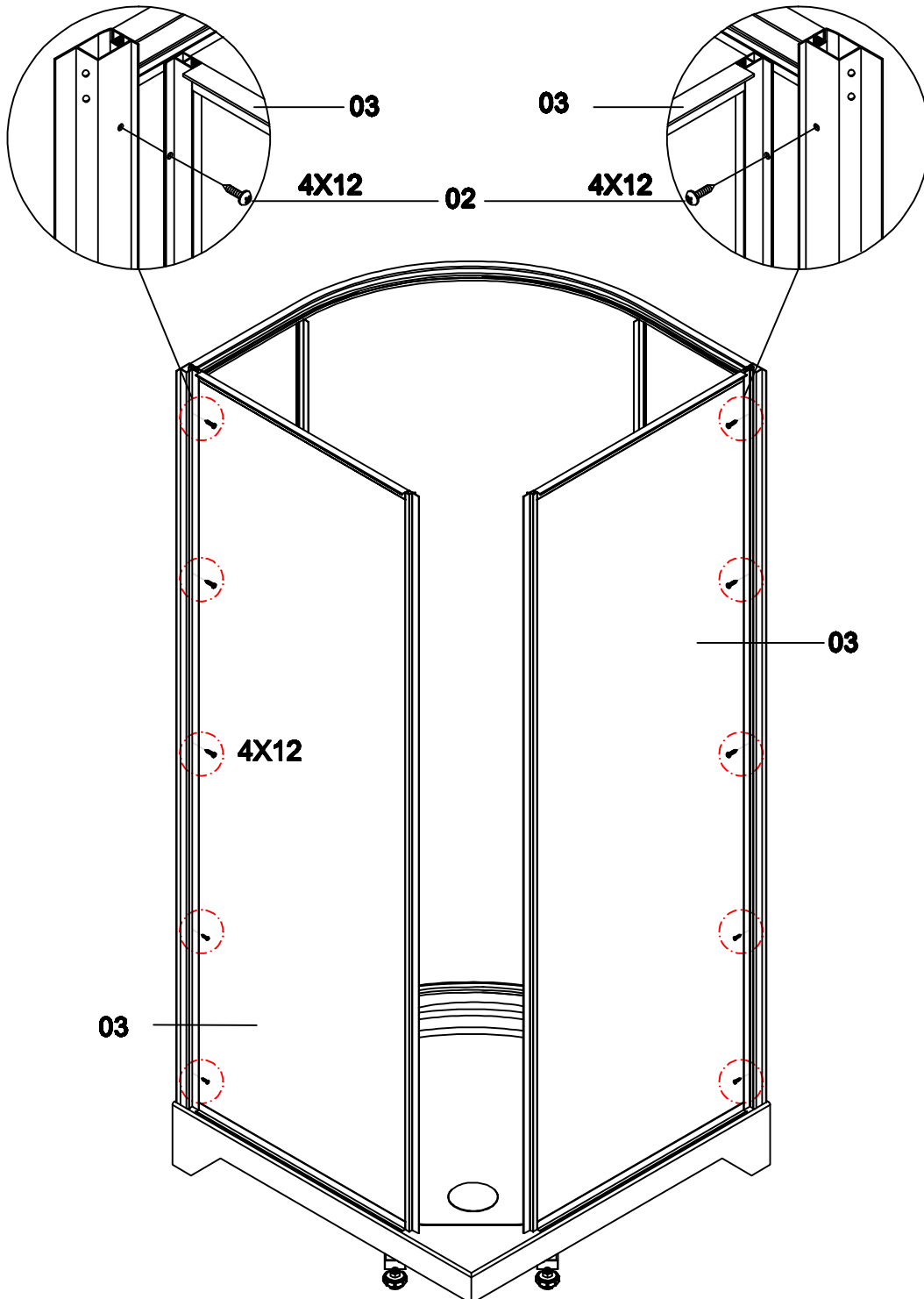
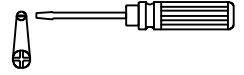
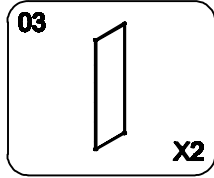
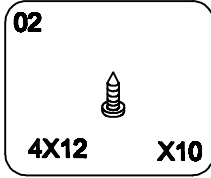



bathlife.
OF SWEDEN

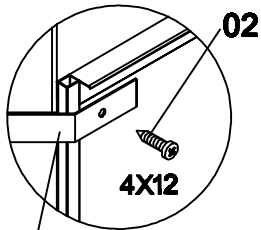
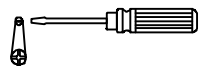
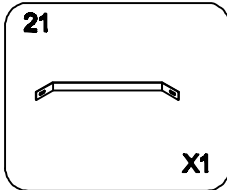
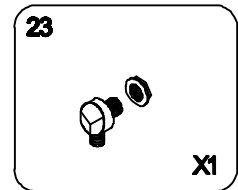
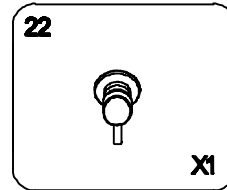
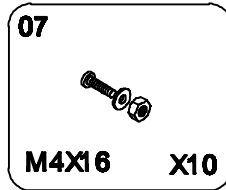
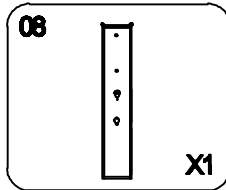
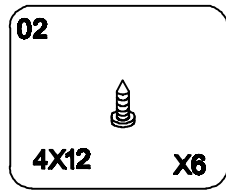

21

02

4X12

03

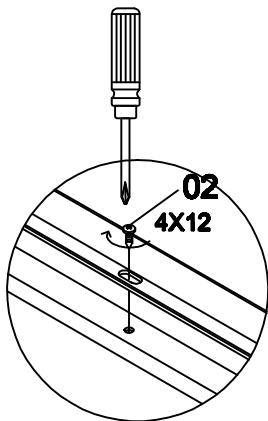

02

4X12

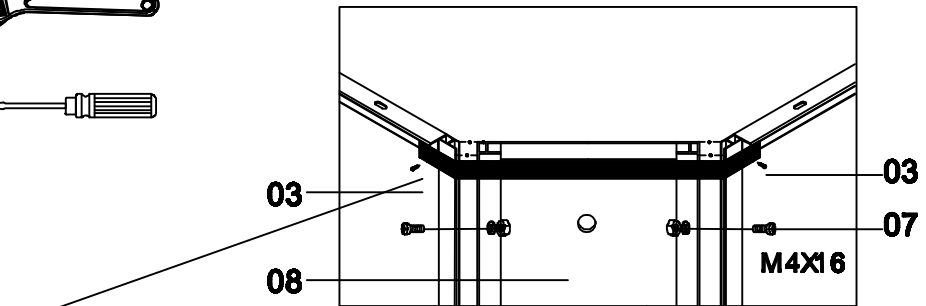

03

03

M4X16

08

07

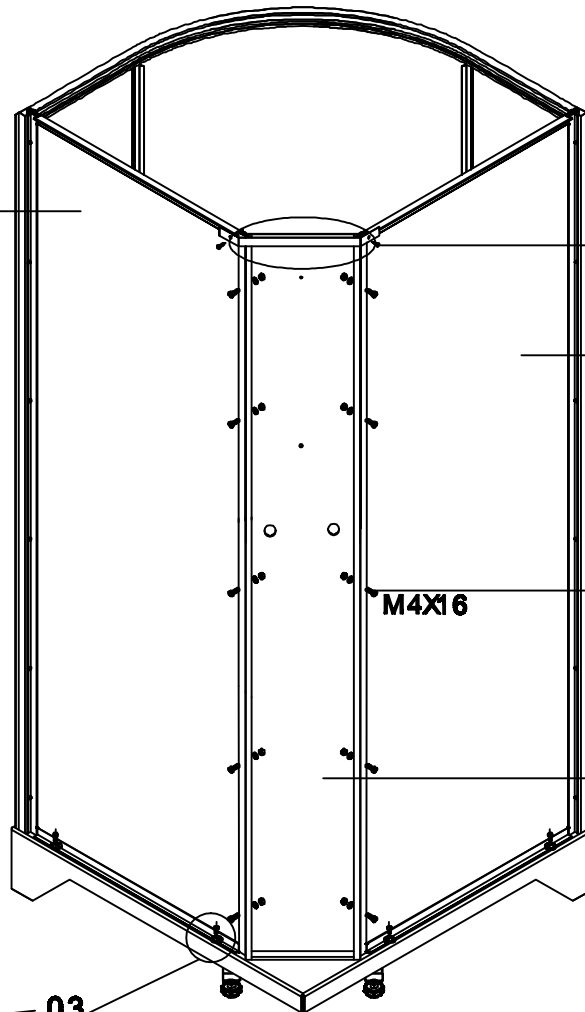

03

M4X16

07

08

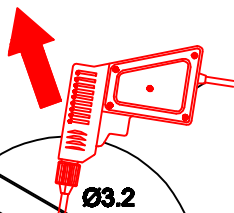

Ø3.2

03

10



bathlife®

OF SWEDEN

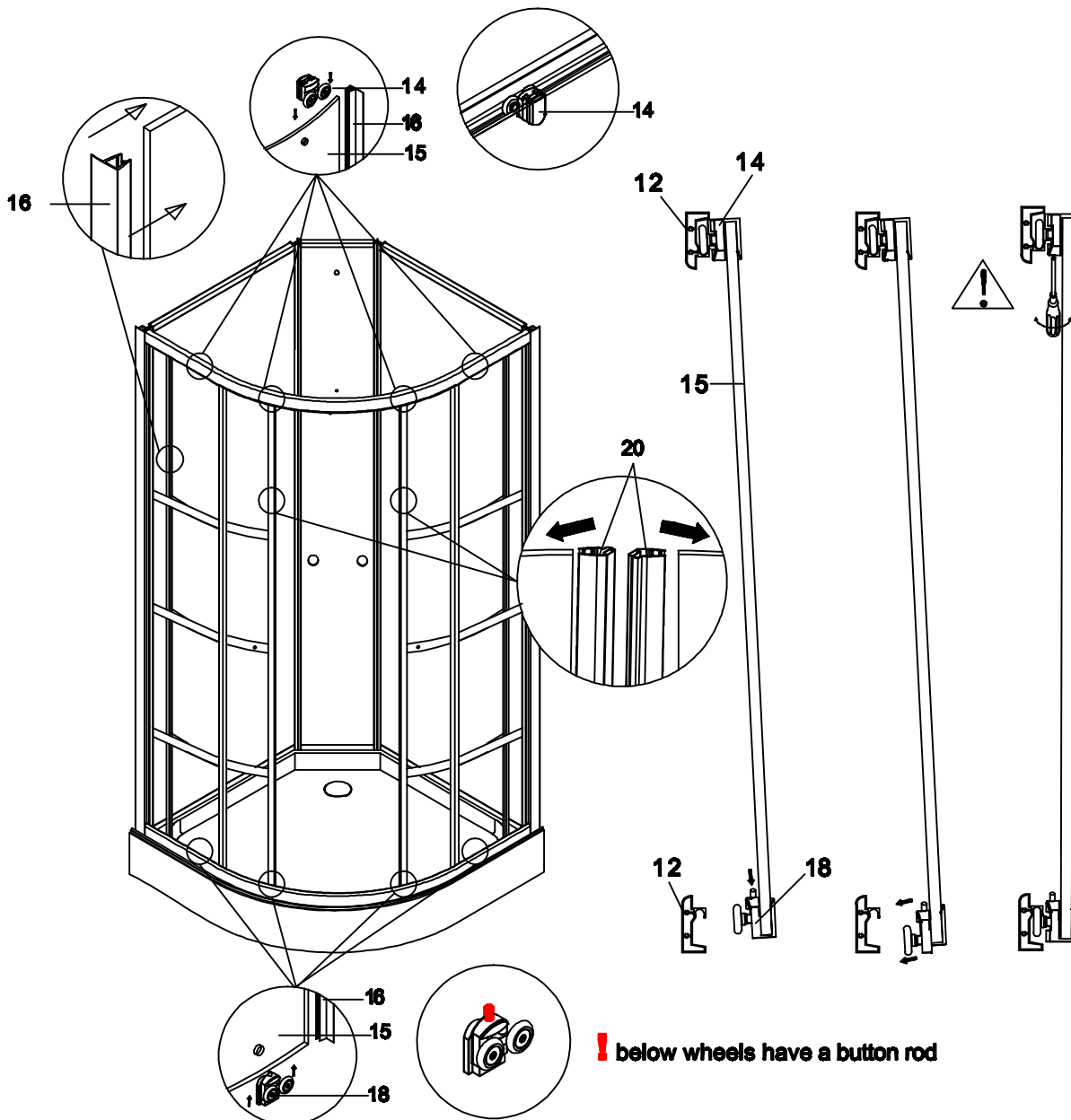
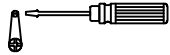
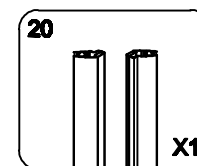
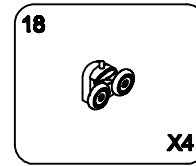
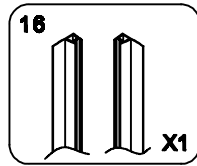
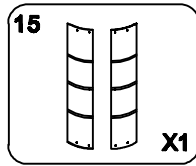
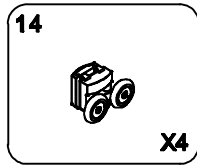



bathlife®
OF SWEDEN

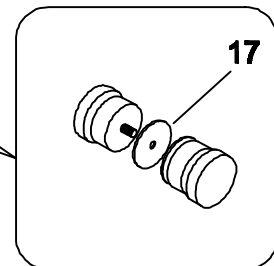
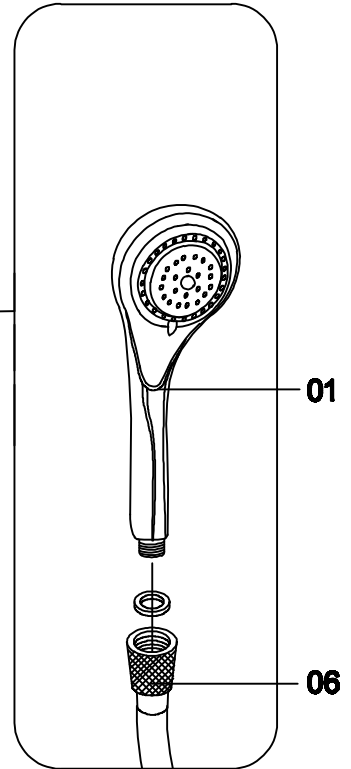
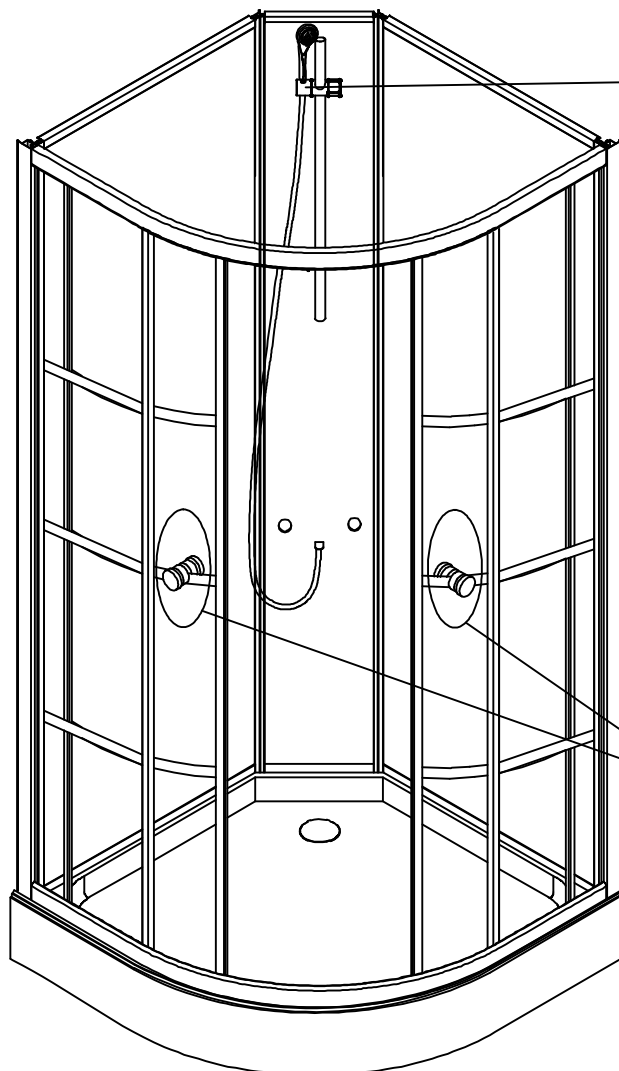
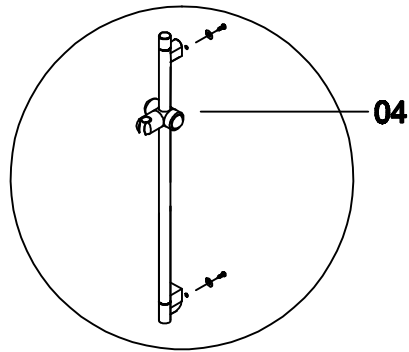
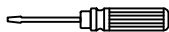
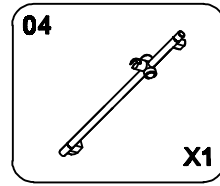
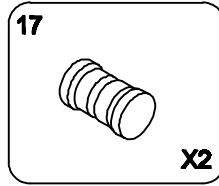
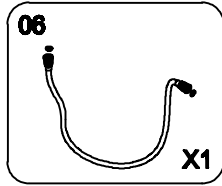
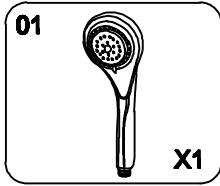



bathlife®
OF SWEDEN

