

de Montageanleitung
*) Über Kundendienst erhältlich

en Installation instructions
*) Available from customer service

fr Notice de montage
*) Disponible par le biais du service après-vente

nl Montagevoorschrift
*) Tegen meerprijs bij de Servicedienst verkrijgbaar

it Istruzioni per il montaggio
*) Disponibili presso il servizio assistenza clienti

el Οδηγίες τοποθέτησης
*) Διαθέσιμα από την υπηρεσία τεχνικής εξυπηρέτησης πελατών

es Instrucciones de montaje
*) Se puede adquirir a través del Servicio de Asistencia Técnica Oficial de la marca

pt Instruções de montagem
*) Pode ser adquirido nos nossos Serviços Técnicos



sv Monteringsanvisning
*) Kan fås via Service

no Monteringsanvisning
*) fåes hos kundeservice

fi Asennusohje
*) Saatavissa huoltopalvelusta

da Monteringsvejledning
*) Kan købes hos serviceafdelingen

lt Montaj kilavuzu
*) Yetkili servis üzerinden alınabilir

ru Инструкция по монтажу
*) Можно получить в сервисном центре

cs Montážní návod
*) K dispozici přes servisní službu

pl Instrukcja montażu
*) Do uzyskania w punkcie serwisowym

hu Szerelési utasítás
*) A vásárlásigazolón keresztül kapható:

tr Uputa za montažu
*) Može dobiti kod službe održavanja

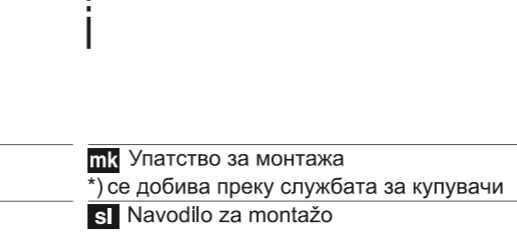

mk Упатство за монтажа
*) се добива преку службата за купувачи

sl Navodilo za montažo
*) lahko nabavite v servisni službi

hr Uputstvo za montažu
*) Može se nabaviti preko servisne službe

et Monteerimisjuhend
*) Küsige klientiteeninduselt

lv Montavimo instrukcija
*) Ja galima gauti klientų aptarnavimo servise

iv Montāžas pamācība
*) Var saņemt servisa dienestā

sk Návod na montáž
*) Dostanete v službe zákazníkom

sq Udhëzues për montim
*) Sigurohet nëpërmjet servisit

bs Uputa za montažu
*) Može se dobiti preko servisne službe

fa راهنمای مونتاژ
*) از مرکز خدمات پس از فروش تهیه فرمایید

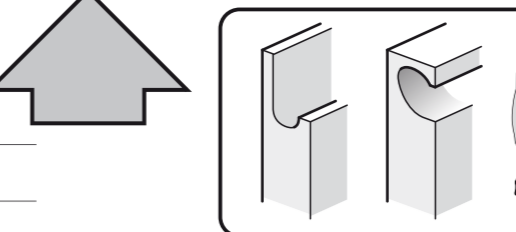

ar تعليمات التركيب
*) يمكن طلبها من مركز خدمة العملاء

ko 설치 설명서
*) 고객센터 서비스 센터에서 구입 가능

zh 安装说明书
*) 可向售后服务站索取

uk Інструкція з монтажу
*) Можна отримати через сервісну службу

ro Instrucțiune de montaj
*) obținabilă la serviciul pentru clienți

id Intruksi Pemasangan
*) bisa didapatkan melalui Customer Service

kk Іске қосу туралы нұсқаулар
*) Сервис қызметі көрсету орталығында алуға жағдай

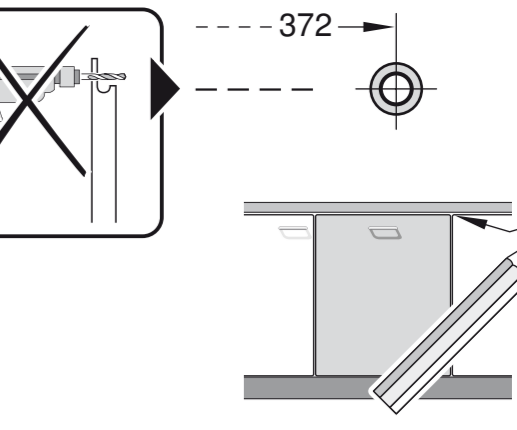

1

2a

2b

3

4

5

6

7

8

9

10

c =	d =
650 mm	≥ 30 mm
660 mm	≥ 20 mm
670 mm	≥ 10 mm
680 - 725 mm	≥ 0 mm

11

31

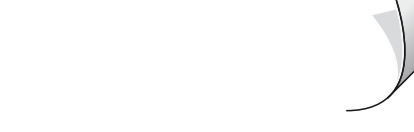
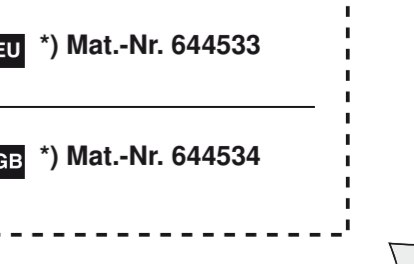
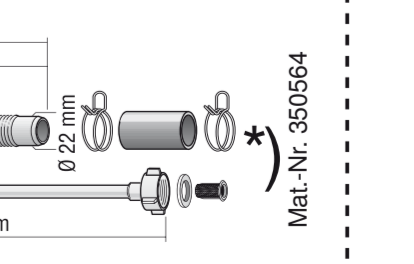
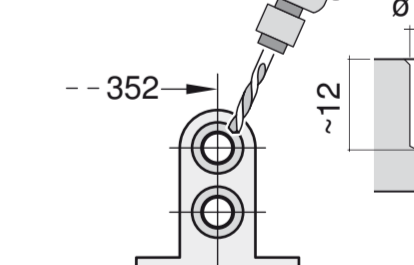



1

1 **2** **3** **4** **5**

815 - 875
450 (max. 458)
100x50mm
815mm

Klick

2h-3h

2a

2b

3

nicht einklemmen
do not pinch
ne pas coincier
No doblar

1 **2** **3** **4** **5** **6** **7**

*) Mat.-Nr. 10011641

4

5

6 **7**

6

7

8

9

10

11

11

12 **13** **14** **15** **16** **17** **18** **19** **20** **21** **22** **23** **24** **25** **26** **27** **28** **29** **30** **31** **32** **33** **34**

min. ø 18 mm
min. 10 mm
0.05 - 1 MPa (0.5 - 10 bar) max. 60°C
FI =

5a **6a** **7a**

6a

7a

8

9

10

11

5a **6a** **7a**

6a

7a

8 **9** **10** **11**

9

10

11