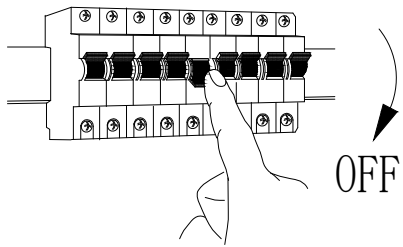
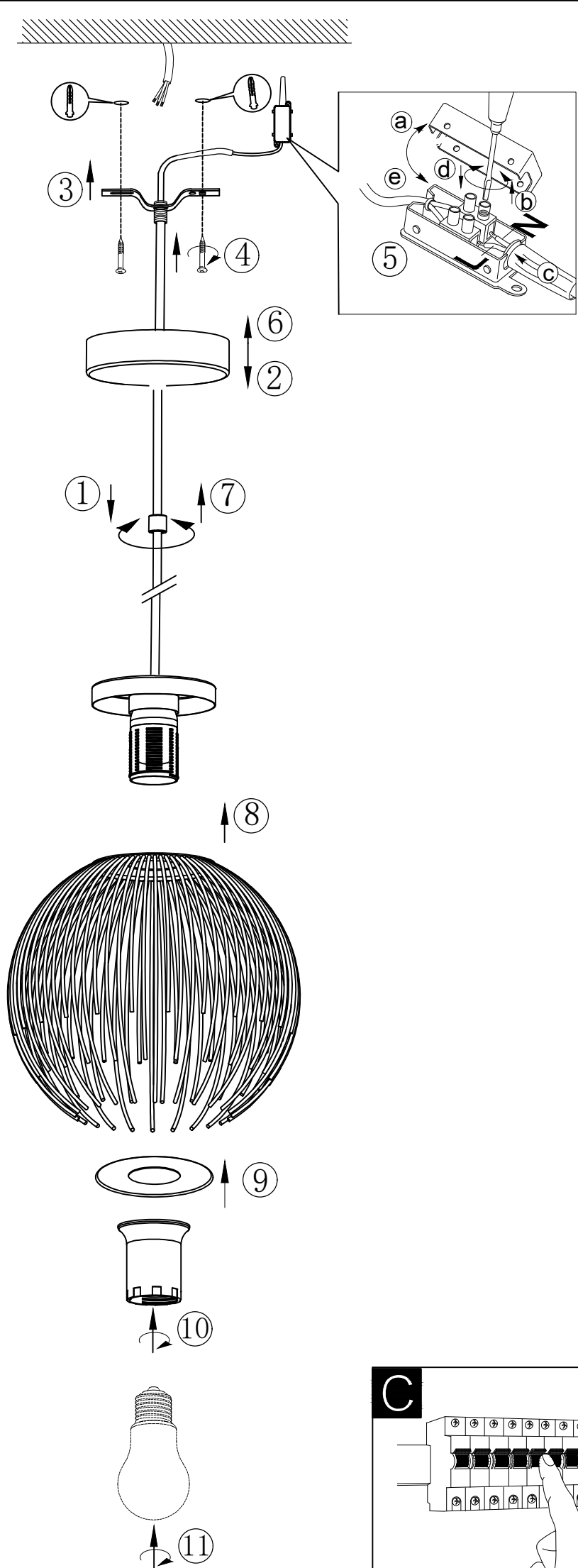
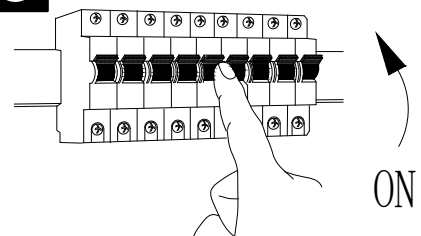

**A****B****C**

BLA900166  
 www.eglo.com