

KSOS

KSOS

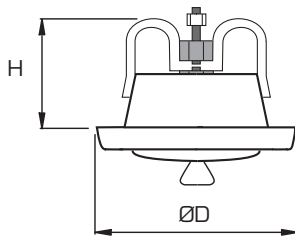

KSO	ØD	A
100	135	71
125	161	85

KKT, KKL

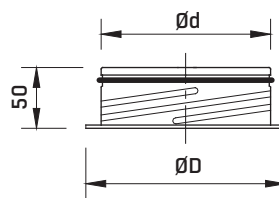

KKU

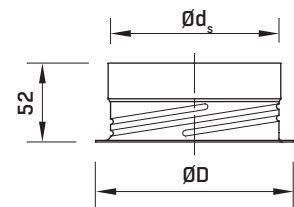

KKT/KKL/KKU	Ød	ØD	Ød _s
100	99	122	100
125	124	148	125

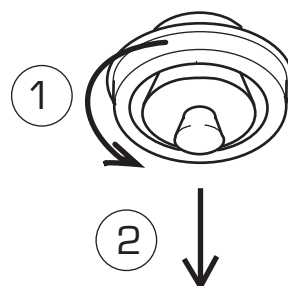
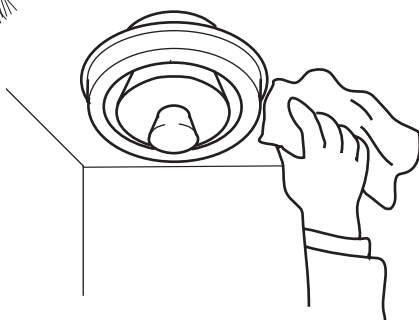

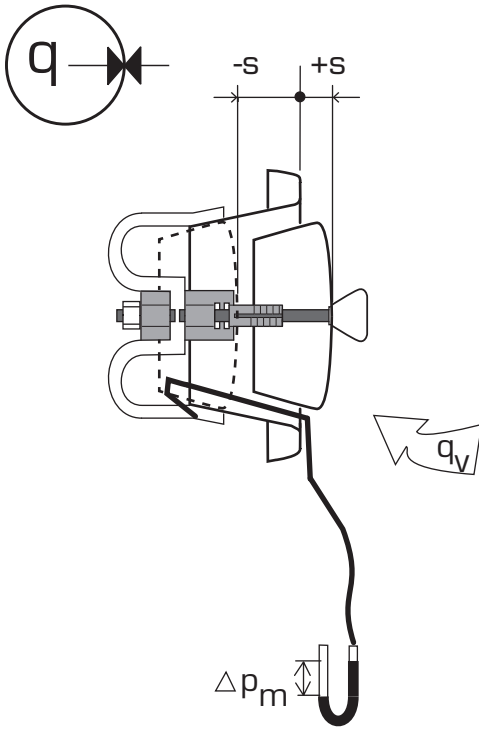
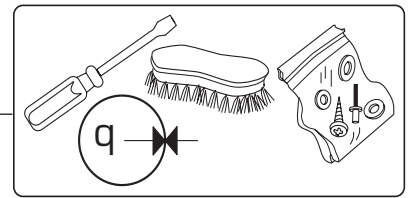

$$q = k \sqrt{\Delta p_m}$$

(l/s) (Pa)

$$q = 3.6k \sqrt{\Delta p_m}$$

(m³/h) (Pa)

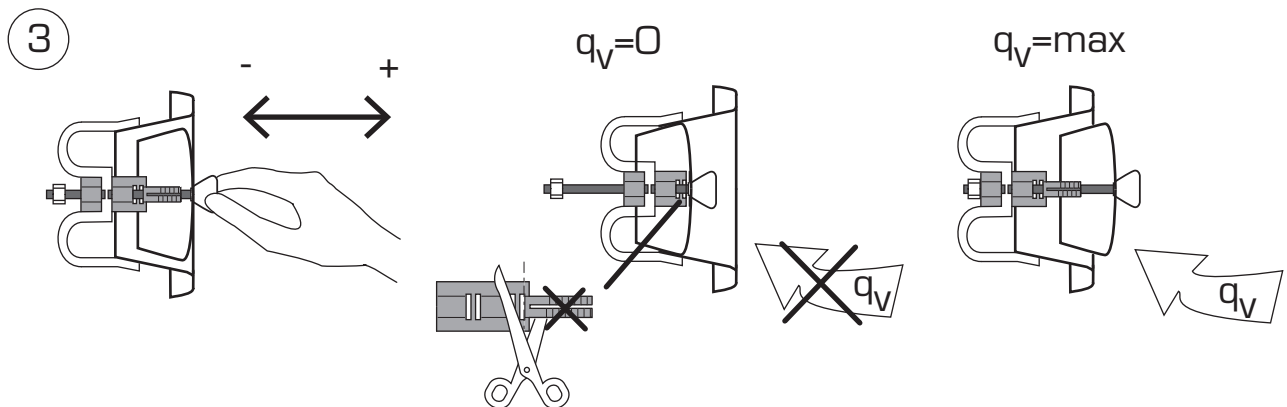
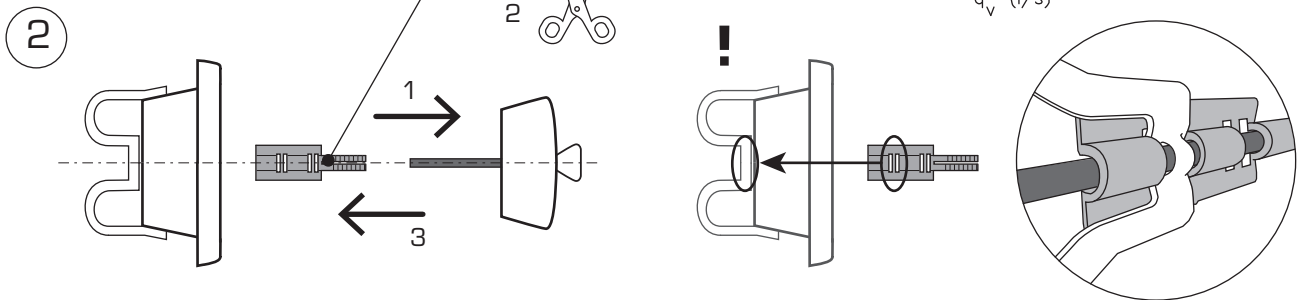
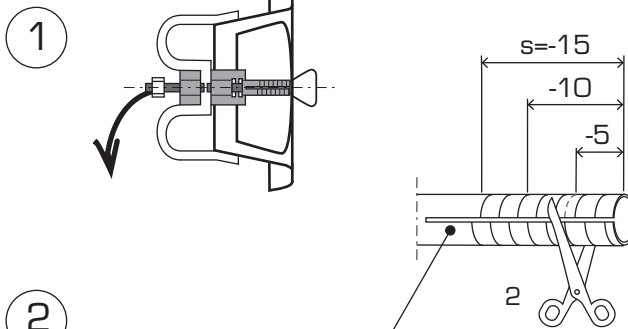
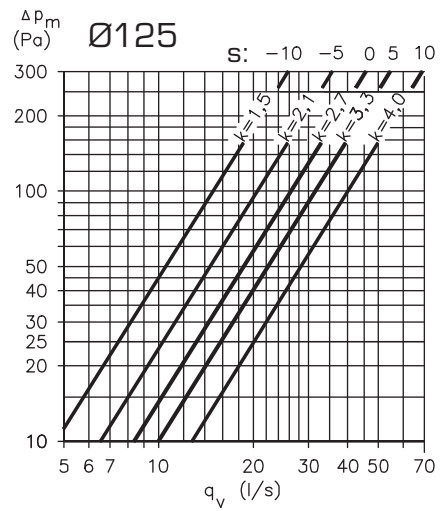
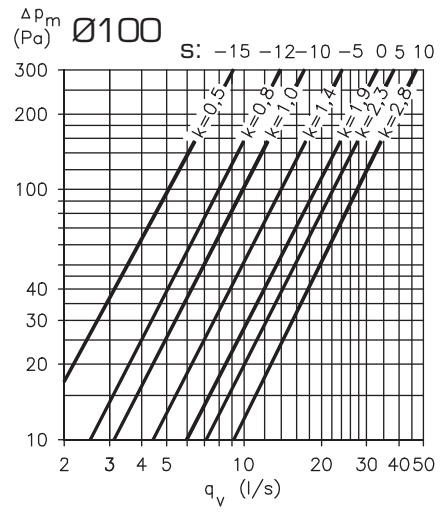

The product reaches its final properties once the sauna is heated up for the first time after installation.
 Tuote saavuttaa lopullisen käyttöominaisuutensa ensimmäisen saunanlämmityskerran jälkeen.
 Produkten uppnår sina slutliga egenskaper efter den första uppvärmningen av bastun.