

harma

S28DN014

S28DN015

S28DN016

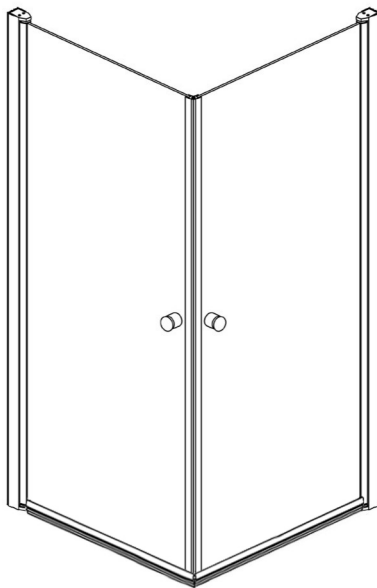

900x900x200 mm

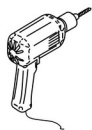
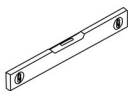

This product is heavy and may require two people to install.



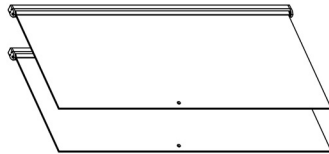
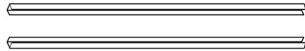
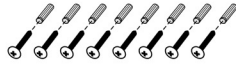

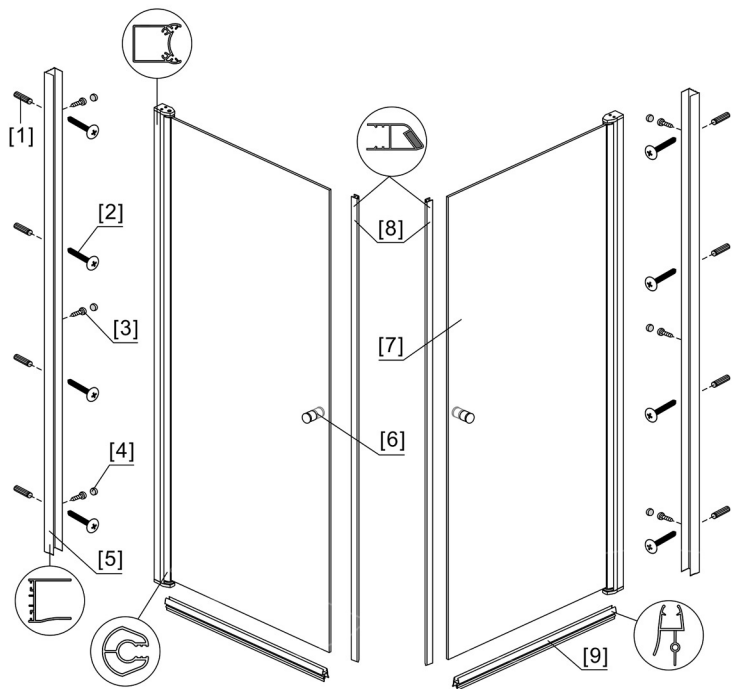

- [1] 9x
- [2] 8x
- [3] 6x
- [4] 6x
- [5] 2x
- [6] 2x

- [7] 2x
- [8] 2x
- [9] 2x

1

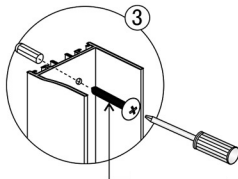
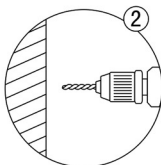
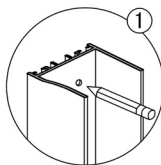
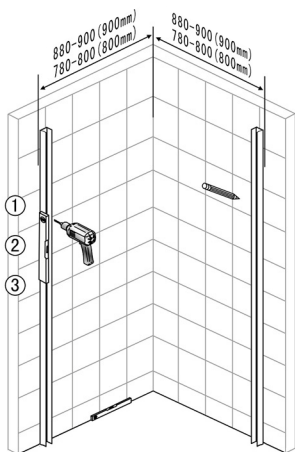

2

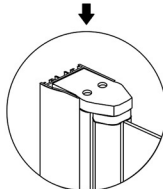
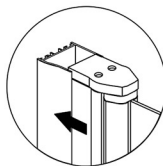
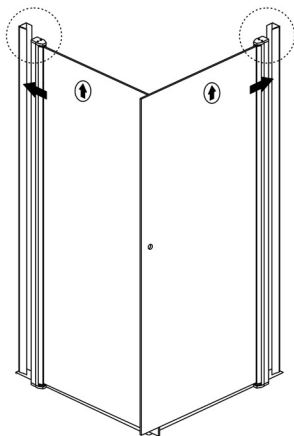

3

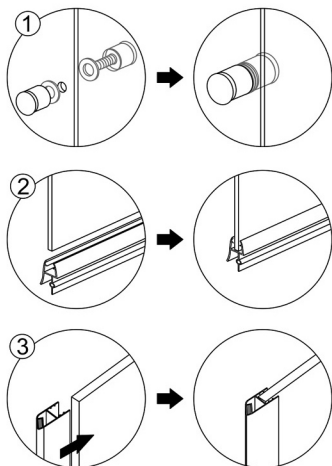
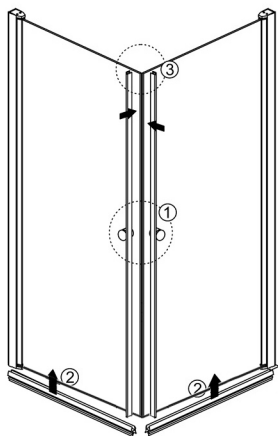

4

