

harma

S28DN017

S28DN018

S28DN019

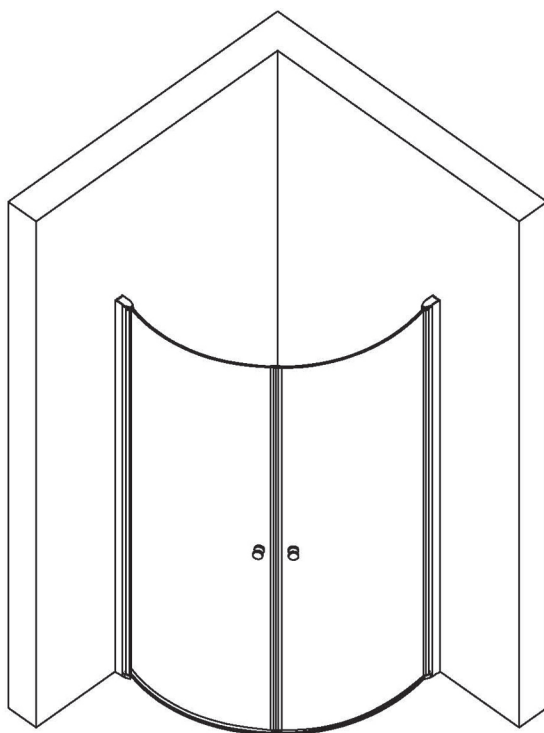





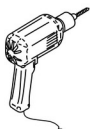
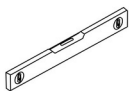

8 8

900x900x200 mm

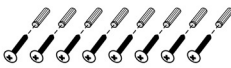

This product is heavy and may require two people to install.

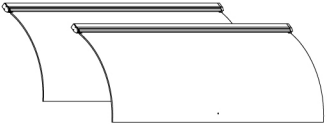

[1]	→	
[2]	→	
[3]	→	
[4]	→	
[5]	→	
[6]	→	
[7]	→	
[8]	→	

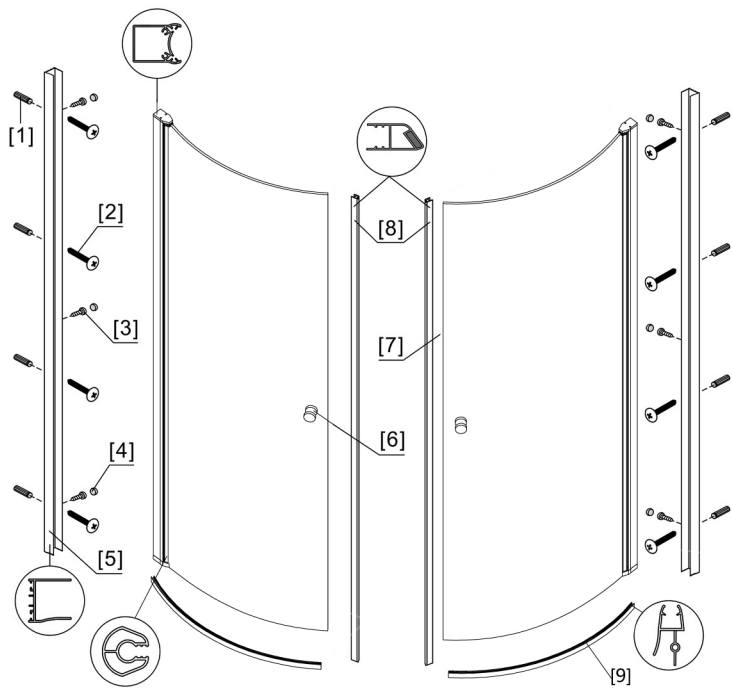

- [1] 9x
- [2] 8x
- [3] 6x
- [4] 6x
- [5] 2x
- [6] 2x

- [7] 2x
- [8] 2x
- [9] 2x

1

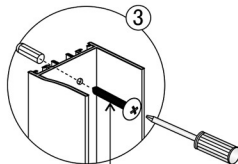
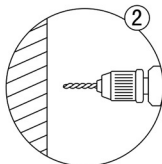
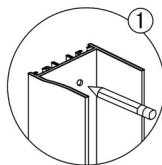
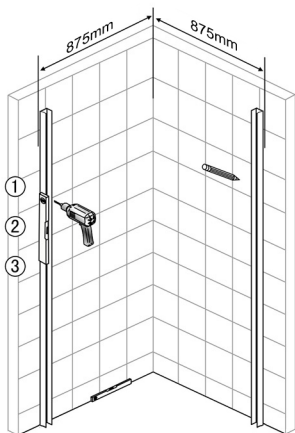

2

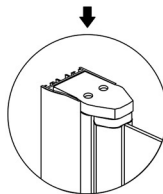
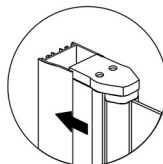
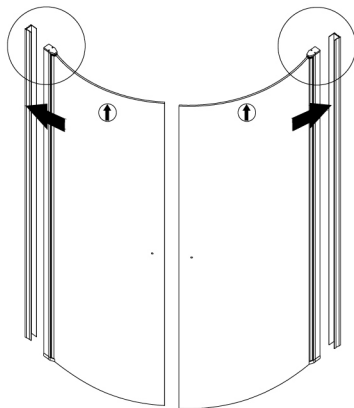

3

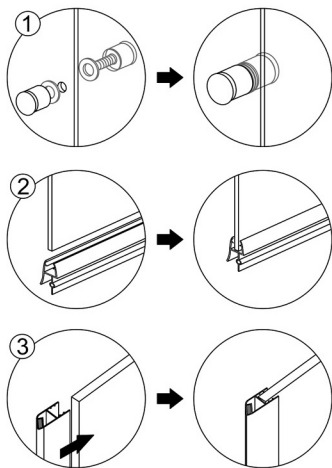
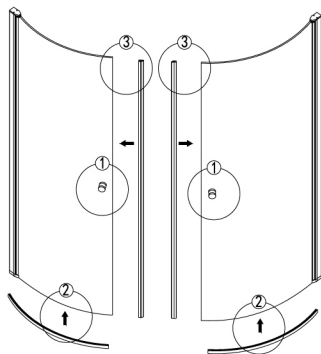

4

