

INSTALLATION MANUAL

MONTERINGSANVISNING
MONTERINGSANVISNING
MONTERINGSVEJLEDNING
ASENNUSOHJE

970.224.00.0(01)

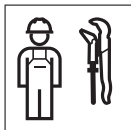

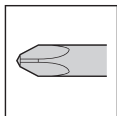
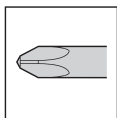

→ **A**  3

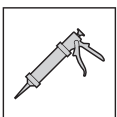

→ **B**  8

A

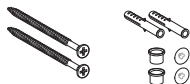
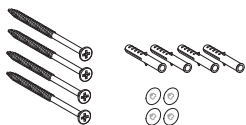
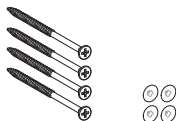

1

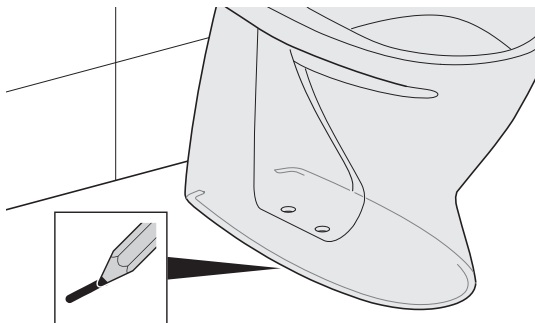

2

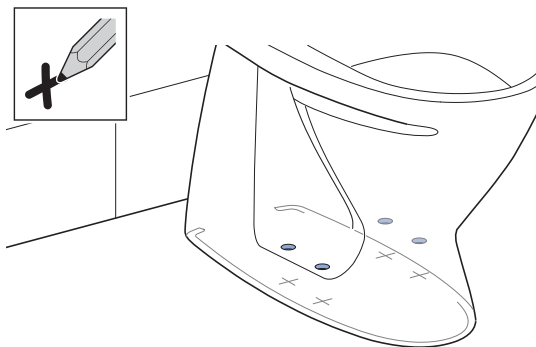

3

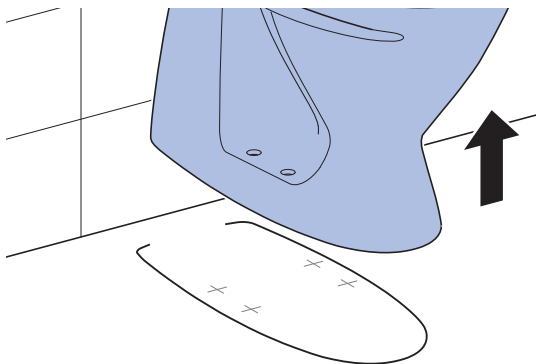

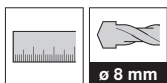
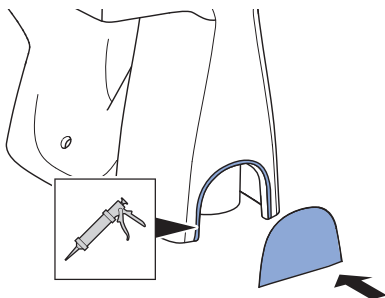

Seven D WC-10

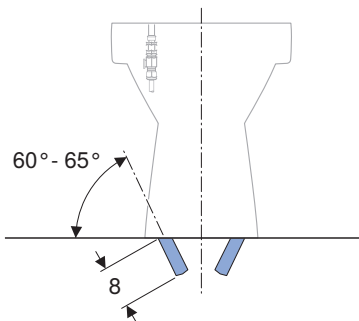

4

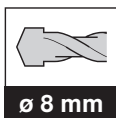

: SWE, FIN, DNK:
EN 15651-3. Class XS1

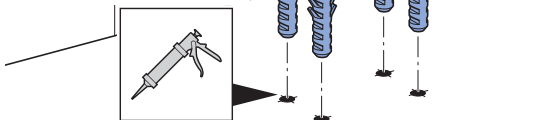

5

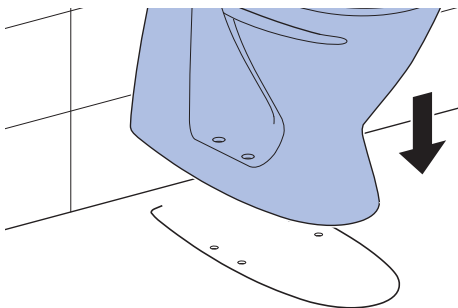
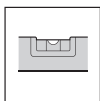

6



: SWE, FIN, DNK:
EN 15651-3. Class XS1

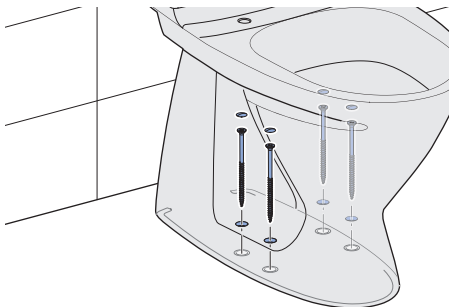

i



ø 5 mm

: SWE, FIN, DNK:
EN 15651-3. Class XS1

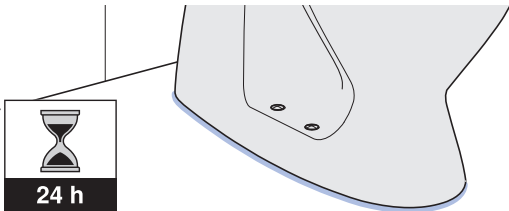

24 h

B



1

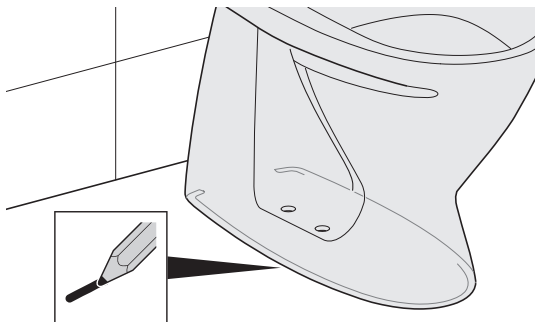

2

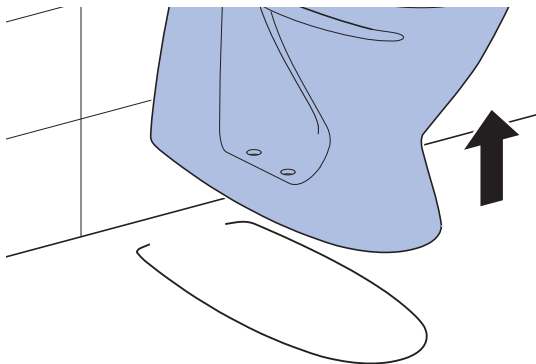

i

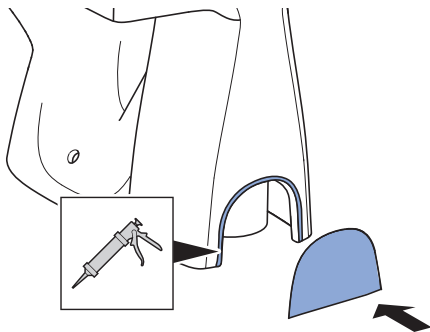

3

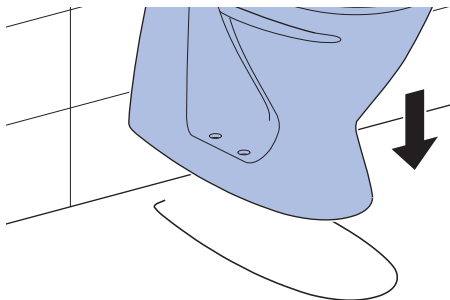
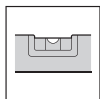

i

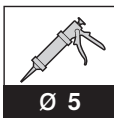
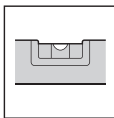

: EN 15651-3. Class XS1

Ø 5

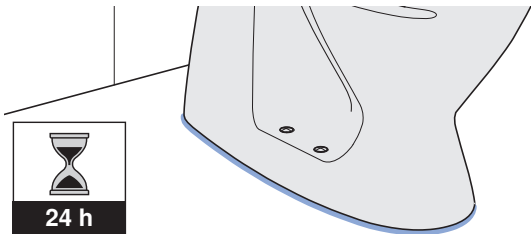

4



: EN 15651-3. Class XS1

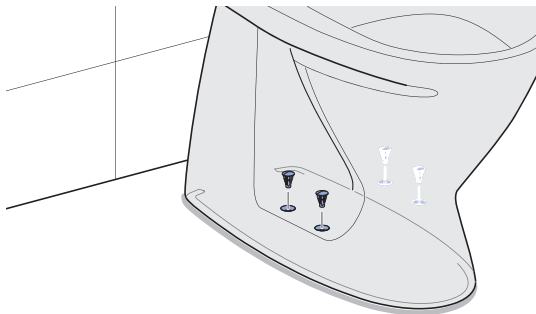

Geberit International AG
Schachenstrasse 77, CH-8645 Jona
documentation@geberit.com
www.geberit.com

