

IDO Posliinivaraosat • Reservdelar av porslin • Ceramic Spare Parts

IDO Seven D 4 & 2,5 I 2006... Itsepalvelupakkaukset • Självbetjäningsförpackningar • Repair sets	3-8
IDO Mosaik 4 & 2,5 I 1999 - 2008 Itsepalvelupakkaukset • Självbetjäningsförpackningar • Repair sets	9-11
IDO Trevi E 4 & 2,5 I 1996... Itsepalvelupakkaukset • Självbetjäningsförpackningar • Repair sets	12-15
IDO Trevi Basic 4/6 I 1993... Itsepalvelupakkaukset • Självbetjäningsförpackningar • Repair sets	16-19
IDO Aniara 6 I 1980 - 1996, 4/6 I 1993 - 2007 Itsepalvelupakkaukset • Självbetjäningsförpackningar • Repair sets	20-22

Seinä-wc:n asennustelineiden varaosat • Reservdelar för fixtur • Spare parts for fixture

IDO SEVEN D -seinä-wc:n asennusteline • vägg-wc fixtur • wall-wc fixture 91372	23-26
ICM - Teline • Fixtur • Fixture 91370, 91371, 91375, 91376	27-30
ICM - Painikkeet • Tryckknappar • Pushbuttons 69080, 69081, 69082	28-30

IDO Showerama -varaosat • Showerama reservdelar • Showerama spare parts

Suihkukaappi 8-5 • Duschkabin 8-5 • Shower cabin 8-5	(2011-)	31-32
Suihkunurkka 8-4 • Duschhörna 8-4 • Corner shower model 8-4	(2012-)	33
Suihkunurkka 8-3 • Duschhörna 8-3 • Corner shower model 8-3	(2013-)	34-35
Liukuovi 8-1 • Nischdusch 8-1 • Sliding door 8-1	(2013-)	36-37
Suihkuseinä 8-0 • Nischdusch 8-0 • Swing door 8-0	(2012-)	38
Suihkuseinä 8-01 • Skärmvägg 8-01 • Swing door 8-01	(2012-)	39
Suihkunurkka 8-02 • Duschhörna 8-02 • Corner shower model 8-02	(2012-)	40
Suihkuseinä 8-20 • Skärmvägg fast 8-20 • Fixed enclosure 8-20	(2013-)	41
Suihkuseinä 8-40 • Badkarskärm 8-40 • Swing door 8-40	(2012-)	42
Suihkuseinä 8-41 • Skärmvägg 8-41 • Swing door 8-41	(2012-)	43
Suihkukaappi 7-5 • Duschkabin 7-5 • Shower cabin 7-5	(2005-2011)	44-45
Suihkunurkka 7-4 • Duschhörna 7-4 • Corner shower model 7-4	(2005-2011)	46
Symmetrinen 7-3 • Symmetrisk 7-3 • Corner shower model 7-3	(2005-2013)	47-48
Epäsymmetrinen 7-2 • Asymmetrisk 7-2 • Asymmetric corner shower model 7-2	(2004-2011)	49
Liukuovi 7-1 • Nischdusch 7-1 • Sliding door 7-1	(2005-2013)	50
Kääntöovi 7-0 • Nischdusch 7-0 • Swing door 7-0	(2005-2011)	51
Suihkuseinä 7-01 • Skärmvägg 7-01 • Swing door 7-01	(2005-2011)	52
Suihkuseinä 7-02 • Duschhörna 7-02 • Shower corner 7-02	(2005-2011)	53
Suihkuseinä 7-40 • Badkarskärm 7-40 • Shower enclosure for bath 7-40	(2005-2012)	54
Suihkuovi 7-41/7-42 • Skärmvägg 7-41/7-42 • Swing door 7-41/7-42	(2005-2011)	55
Suihkuseinä 2-0, Duschvägg 2-0, Shower enclosure 2-0	(2005-2013)	56
Suihkukaappi 6-5 • Duschkabin 6-5 • Shower cabin 6-5	(1999-2004)	57
Suihkunurkka 6-3 • Duschhörna 6-3 • Corner shower model 6-3	(1999-2004)	58
Liukuovi 6-1 • Nischdusch 6-1 • Sliding door 6-1 (1200-1450 mm)	(1999-2004)	59
Liukuovi 6-1/6-10 • Nischdusch 6-1/6-10 • Sliding door 6-1/6-10 (1500-1800 mm)	(1999-2004)	60
Kääntöovi 6-0 • Svängdörr 6-0 • Swing door modell 6-0 (700-1150 mm)	(1999-2004)	61
Showerama 61, 62, 63, 65	(1999-1999)	62

Kylpyammeiden varaosat • Badbadkar reservdelar • Bathtubs spareparts

IDO Trevi 1400, 1500, 1600, 1700 mm	63
IDO Seven D Seven D Image 1600, 1700 mm	64-65
IDO Seven D Seven D nurkka/hörn/corner 95370	64-65
IDO Seven D Seven D epäsymmetrinen/assymetrisk/asymmetric 95360, -61, -62, -63	65

Kylpyhuonekalusteiden varaosat • Badrumsmöbler reservdelar • Bathroom furniture, spare parts
IDO Seven D

Alakaappi • Underskåp • Base cabinet 97923, 97924, 97925, 97926, 97927	66-67
Yläkaappi • Överskåp • Upper cabinet 97911	68
Alakaappi • Underskåp • Base cabinet 97910	69
Alakaappi • Underskåp • Base cabinet 97930, 97931	70
Korkeakaappi • Högskåp • High cabinet 98928	71
Yläkaappi • Överskåp • Upper cabinet 97905	72

IDO Trend

Alakaappi • Underskåp • Base cabinet 97800, 97801, 97802	73-74
Korkeakaappi • Högskåp • High cabinet 97803	75
Muut • Övrigt • Other	76

IDO Select

Yläkaappi • Överskåp • Upper cabinet 97604, 98604	77
Korkeakaappi • Högskåp • High cabinet 97600, 98600	78
Sivukaappi • Sidoskåp • Side cabinet 98302, 98402, 98502	79
Korkeakaappi • Högskåp • High cabinet 97603	80
Korkeakaappi • Högskåp • High cabinet 97601, 97602	81
Alakaappi • Underskåp • Base cabinet 98303/97303, 98403/97403, 98503/97503	82
Alakaappi • Underskåp • Base cabinet 97301/98301, 97401/98401, 97501/98501	83
Alakaappi • Underskåp • Base cabinet 97300/98300, 97400/98400, 97500/98500	84
Ovet, laatikonpäät, etusovitteet • Dörrar, lådfronter, frontdelar • Doors, drawer ends, front adapter arch	85-90
Muut • Övrigt • Other	91

IDO Renova Plus

Alakaappi • Underskåp • Base cabinet 94131	92
Alakaappi • Underskåp • Base cabinet 94331, 94299, 94399	93-94
Yläkaappi • Överskåp • Upper cabinet 94709	95
Korkeakaappi • Högskåp • High cabinet 94700	96

IDO Renova

Alakaappi • Underskåp • Base cabinet 93131	97
Alakaappi • Underskåp • Base cabinet 93500	98

IDO Smart

Alakaappi • Underskåp • Base cabinet 96340	99
Alakaappi • Underskåp • Base cabinet 96351	100
Alakaappi • Underskåp • Base cabinet 96360	101
Yläsivukaappi • Överskåp • Upper cabinet 96307	102
Korkeakaappi • Högskåp • High cabinet 96311	103

IDO Peilit ja peilikaapit • Speglar och spegelskåp • Mirrors and mirror cabinets

Peilikaappi • Spegelskåp • Mirror cabinet 98934, 98935	104
Peilikaappi • Spegelskåp • Mirror cabinet 97920	105
Peilikaappi • Spegelskåp • Mirror cabinet 97921	106
Peilikaappi • Spegelskåp • Mirror cabinet 97922	107
Peilikaappi • Spegelskåp • Mirror cabinet 94428, 94728, 94429, 94729, 94430, 94730	108-109
Peilikaappi • Spegelskåp • Mirror cabinet 94431	110
Peilikaappi • Spegelskåp • Mirror cabinet 97615	111
Peilikaappi • Spegelskåp • Mirror cabinet 97616	112
Peilikaappi • Spegelskåp • Mirror cabinet 97617	113
Peilikaappi • Spegelskåp • Mirror cabinet 97618	114
Peilikaappi • Spegelskåp • Mirror cabinet 93427, 93428	115
Peilikaappi • Spegelskåp • Mirror cabinet 96377, 96380	116
Peili • Spegel • Mirror 98996	117
Tasopeili LED • Planspegel LED • Plane mirror with LED 94620, 94621, 94622, 94623, 94624, 94625	118
Loisteputkilamppu • Lysrörsarmatur • Fluorescent lamp 97610, 97611, 97612	119
Muut • Övrigt • Other	120

IDO SEVEN D 4 & 2, 5 I 2006...

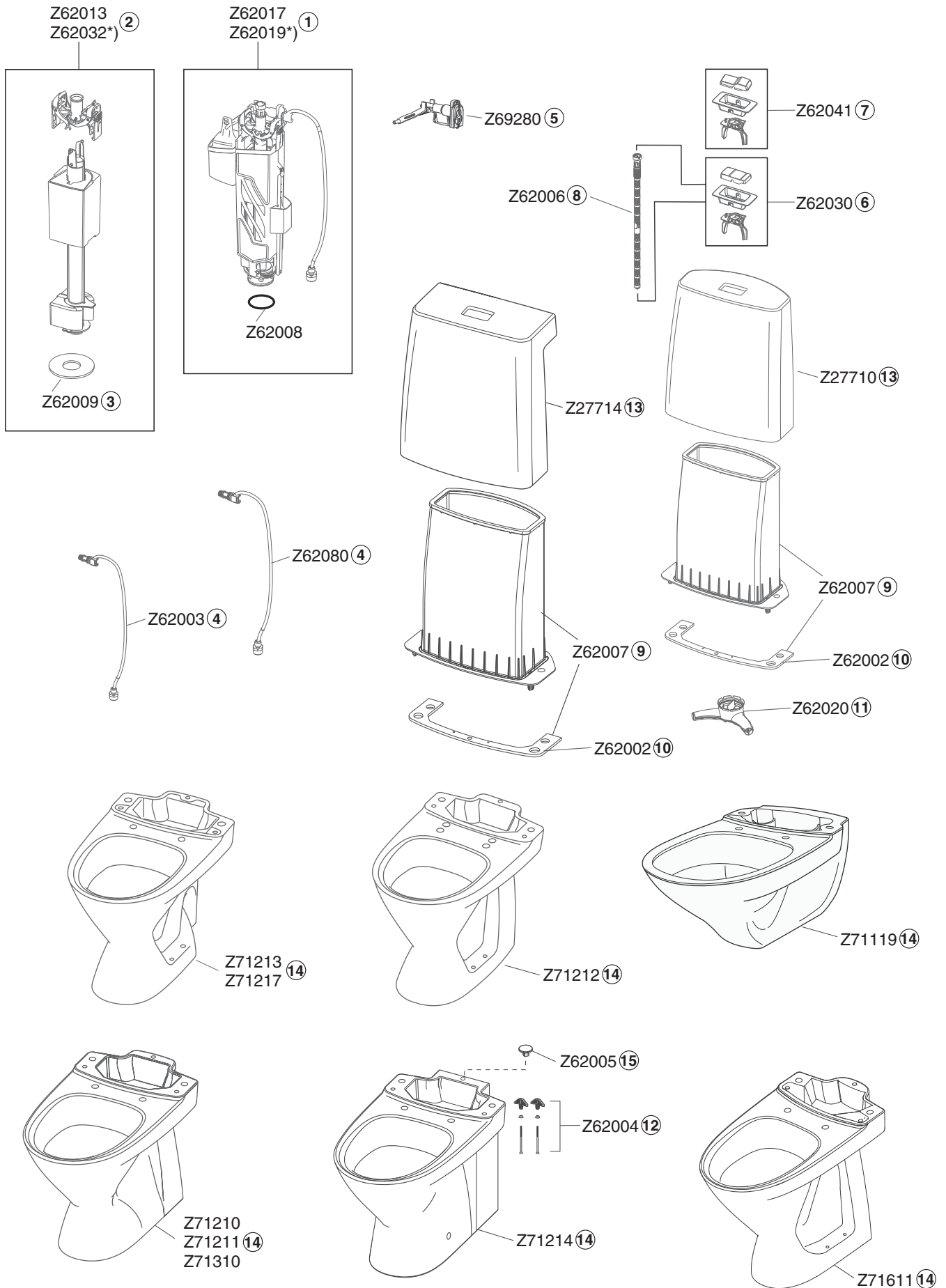

*) yksöishuhtelu • enkelspolning • single flush

IDO SEVEN D SLIM 4 & 2, 5 l 2006...

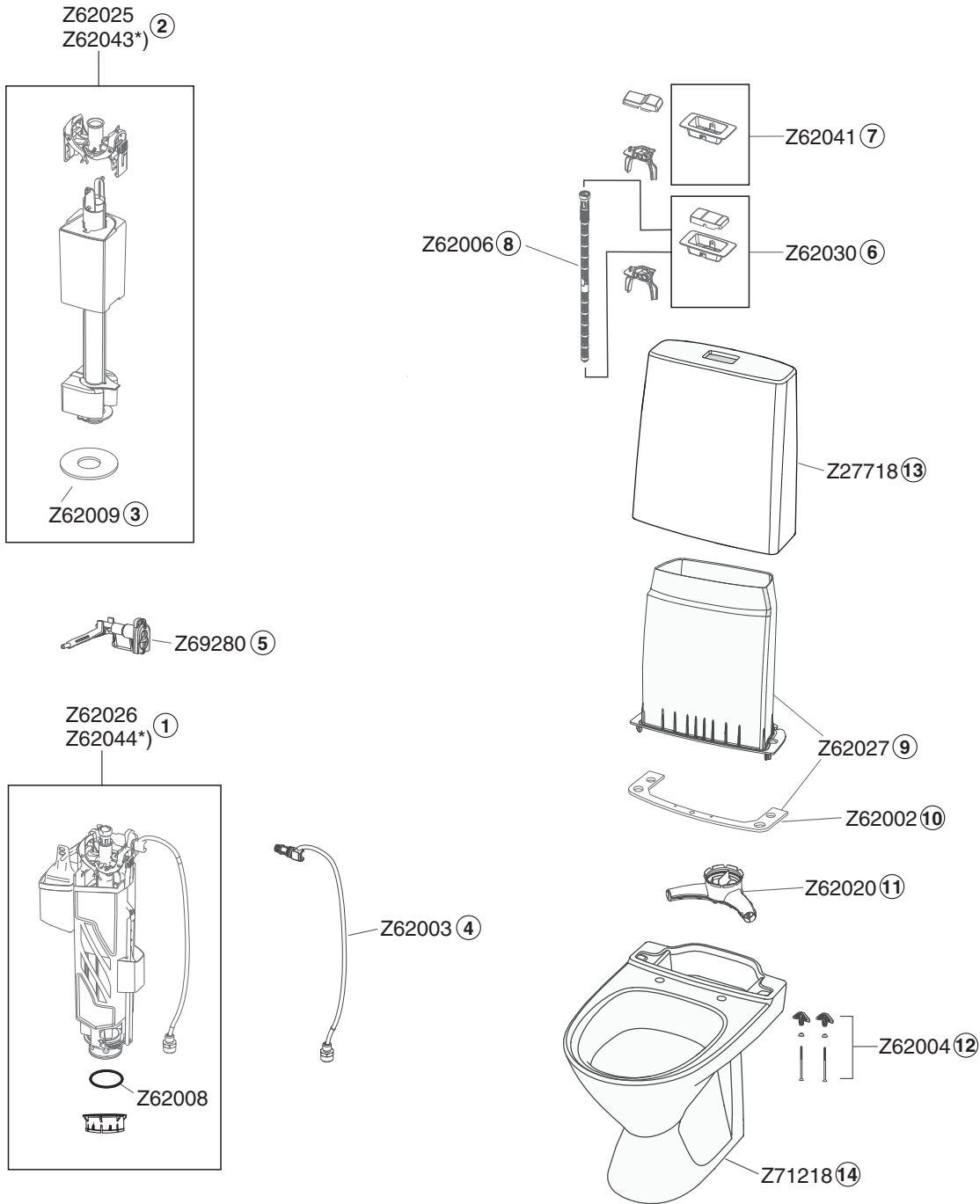











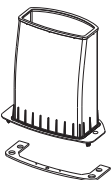











*) yksöishuhtelu • enkelspolning • single flush



















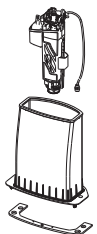

IDO SEVEN D 4 & 2, 5 I 2006...

	Tuote Produkt Product	LVI- numero VVS- nummer	Nimike Benämning Item	Suositus- hinta Riktpris Price 24 % euro	Suositus- hinta Riktpris Price 0 % euro	EAN
	Z6201700001	5731203	Venttiilarja, kaksoishuuhtelu Ventil, komplett, dubbelspolning Valve kit complete, double flush	91,10	73,50	6441612913624951
	Z6202600001	5731336	Venttiilarja, kaksoishuuhtelu -18, Slim Ventil, komplett, dubbelspolning -18, Slim Valve kit complete, double flush -18, Slim	91,10	73,50	6441612913645501
	Z6201900001	5731239	Venttiilarja, yksöishuuhtelu Ventil, komplett, enkelspolning Valve kit complete, single flush	91,10	73,50	6441612913630651
	Z6204400001	5731324	Venttiilarja, yksöishuuhtelu -18, Slim Ventil, komplett, enkelspolning -18, Slim Valve kit complete, single flush -18, Slim	91,10	73,50	6441612913615591
	Z6201300001	5731240	Huuhteluventtiili, kaksoishuuhtelu Utloppsventil, dubbelspolning Flush valve complete, double flush	32,60	26,25	6441612913630721
	Z6202500001	5731333	Huuhteluventtiili, kaksoishuuhtelu -18, Slim Utloppsventil, dubbelspolning -18, Slim Flush valve complete, double flush -18, Slim	32,60	26,25	6441612913645431
	Z6203200001	5731204	Huuhteluventtiili, yksöishuuhtelu Utloppsventil, enkelspolning Flush valve complete, single flush	32,60	26,25	6441612913625011
	Z6204300001	5731323	Huuhteluventtiili, yksöishuuhtelu -18, Slim Utloppsventil, enkelspolning -18, Slim Flush valve complete, single flush -18, Slim	32,60	26,25	6441612913615421
	Z6200900001	5731242	Pohjaventtiilin tiiviste Bottenventilens tätning Flush valve sealing	3,90	3,15	6441612913629521
	Z6200300001	5731243	Tuloputki kytkentöineen Inloppsslang, komplett Inlet hose complete	26,00	21,00	6441612913630961
	Z6208000001	5731126	Tuloputki kytkentöineen -19, seinä-wc Inloppsslang, komplett -19, vägg-wc Inlet hose complete -19, wall-hung wc	26,00	21,00	6441612912016951
	Z6928000001	5731254	Täyttöventtiili, täydellinen Inloppsventil, komplett Inlet valve complete	7,80	6,30	6441612913632871
	Z6203000001	5731205	Painike, kromi, kaksoishuuhtelu Tryckknapp, krom, dubbelspolning Push button, chrome, double flush	15,60	12,60	6441612913625181
	Z6204100001	5731241	Painike, kromi, yksöishuuhtelu Tryckknapp, krom, enkelspolning Push button, chrome, single flush	15,60	12,60	6441612913630891

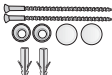

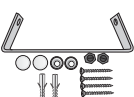

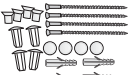













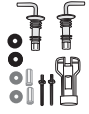

IDO SEVEN D 4 & 2, 5 I 2006...

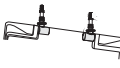
	Tuote Produkt Product	LVI- numero VVS- nummer	Nimike Benämning Item	Suositus- hinta Riktpris Price 24 % euro	Suositus- hinta Riktpris Price 0 % euro	EAN	
8		Z6200600001	5731251	Kansiruuvi, sininen Lockskruv, blå Multibolt, blue	3,90	3,15	
9		Z6200700001	5731220	Sisäsäiliö + tiiviste Innercistern inkl. packning Innertank with gasket	44,30	35,70	
		Z6202700001	5731318	Sisäsäiliö + tiiviste -18 Innercistern inkl. packning -18 Innertank with gasket -18	44,30	35,70	
10		Z6200200001	5731212	Säiliön tiiviste Cisternpackning Cistern sealing	6,50	5,25	
11		Z6202000001	5731244	Huhteluputki Spolrör Water distribution pipe	3,90	3,15	
12		Z6200400001	5731206	Säiliön kiinnitysruuvit Cisternfäste Cistern fixing screws	5,20	4,20	
13		Z2771001001	5650070	Säiliö -10, -11, -12, -13, -17, -19 Cisternkäpa -10, -11, -12, -13, -17, -19 Cistern -10, -11, -12, -13, -17, -19	128,90	103,95	
		Z2771401001	5650079	Säiliö -14 Image Cisternkäpa -14 Image Cistern -14 Image	168,00	135,45	
		Z2771801001	5650080	Säiliö -18 kapea Cisternkäpa -18 slim Cistern -18 slim	128,90	103,95	
14		Z7111901001	5650087	WC-kulho -19 WC-skål -19 WC-bowl -19	260,40	210,00	
		Z7121001001	5650081	WC-kulho -10, 2 kiinnitysreikä WC-skål -10, 2-håls WC-bowl -10, 2 fixing holes	260,40	210,00	
		Z7121101001	5650083	WC-kulho -11 WC-skål -11 WC-bowl -11	260,40	210,00	
		Z7121201001	5650084	WC-kulho -12 WC-skål -12 WC-bowl -12	325,50	262,50	
		Z7121301001	5650085	WC-kulho -13 WC-skål -13 WC-bowl -13	260,40	210,00	
		Z7131301001	5650104	WC-kulho -13, ei kiinnitysreikä WC-skål -13, utan hål WC-bowl -13, no fixing holes	260,40	210,00	

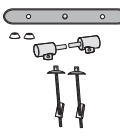
IDO SEVEN D 4 & 2, 5 l 2006...

	Tuote Produkt Product	LVI- numero VVS- nummer	Nimike Benämning Item	Suositus- hinta Riktpris Price 24 % euro	Suositus- hinta Riktpris Price 0 % euro	EAN				
14		Z7161101001	5650092	WC-kulho - I I	325,50	262,50				
				WC-skål - I I						
				WC-bowl - I I						
				Z7121401001	5650072	WC-kulho - I4		390,60	315,00	
				WC-skål - I4						
WC-bowl - I4										
Z7121701001	5650074	WC-kulho - I7	325,50	262,50						
WC-skål - I7										
WC-bowl - I7										
Z7121801001	5650086	WC-kulho - I8	260,40	210,00						
WC-skål - I8										
WC-bowl - I8										
Z7131001001	5650082	WC-kulho - I0, ei kiinnitysreikiä	260,40	210,00						
WC-skål - I0, utan hål										
WC-bowl - I0, no fixing holes										
15		Z6200500001	5731250	Peitetulppa	3,90	3,15				
				Plugg wc-skål						
				Bowl plug						
		Z6200800001	5731282	O-Tiiviste	3,90	3,15				
				O-Ring för ventilsåte						
				O-Ring						
		Z6200100001	5731221	Sisäsäiliö + venttiili, täydellinen, kaksoishuhtelu	130,20	105,00				
				Innertank + valve complete, double flush						
		Z6204000001	5731222	Sisäsäiliö + venttiili, täydellinen, yksöishuhtelu	130,20	105,00				
				Innertank + valve complete, single flush						
		Z6202100001	5731219	Huhteluputki, wc - I5	6,50	5,25				
				Spolrör, wc - I5						
				Water distribution pipe, wc - I5						
		Z6205000001	5731213	Kiinnitysarja, 2 kiinnitysreikää	13,00	10,50				
				Monteringsatts, 2-håls						
				Fixing kit, 2 fixing holes						
		Z6205100001	5731214	Kiinnitysarja, -I4 Image	5,20	4,20				
				Monteringsatts, -I4 Image						
				Fixing kit, -I4 Image						
		Z6205200001	5731215	Kiinnitysarja, 4 kiinnitysreikää	5,20	4,20				
				Monteringsatts, 4-håls						
				Fixing kit, 4 fixing holes						

IDO SEVEN D 4 & 2, 5 I 2006...

	Tuote Produkt Product	LVI- numero VVS- nummer	Nimike Benämning Item	Suositus- hinta Riktpris Price 24 % euro	Suositus- hinta Riktpris Price 0 % euro	EAN
	Z6400100001	5731209	Tuloputken liitin 10 mm Koppling för inloppsrör 10 mm Coupling for inlet pipe 10 mm	24,80	20,00	
	Z6300100001	5731211	Tuloputken liitin 12 mm Koppling för inloppsrör 12 mm Coupling for inlet pipe 12 mm	6,50	5,25	
	Z6404900001	5731207	Sulkuventtiili Avstängningsventil Stop valve	22,10	17,85	
	Z6405000001	5731208	Sulkuventtiili, 45 asteen kulma (WC I4 Image) Avstängningsventil, vinkel 45 gr (WC I4 Image) Stop valve, angular (WC I4 Image)	33,90	27,30	
	Z6405600001	5731245	Saranat pehmeä kansi 91130 Gängledssats mjüksits 91130 Hinges for soft seat 91130	9,10	7,35	
	Z9153900001	5731252	Kumivaimennin istuimelle Buffert för hårdsets Seat bumpers	6,50	5,25	
	Z9153700001	5711272	Saranat qr/kiinteä istuin 91537 Gängledsats qr/ff hårdsets 91537 Hinges qr/ff seat 91537	31,20	25,20	
	Z9154200001	5711271	Saranat sc/qr/kiinteä istuin 91542 Gängledsats sc/qr/ff hårdsets 91542 Hinges sc/qr/ff seat 91542	59,90	48,30	
	Z9154900001	5711119	Saranat sc istuin 91533 Gängledsats sc hårdsets 91533 Hinges sc seat 91533	59,90	48,30	
	Z6205600001	5731268	Kiinnityssarja Image 20 Fischer 225 mm Fastsättning Image 20 Fischer 225 mm Fixing kit Image 20 Fischer 225 mm	33,90	27,30	
	Z6205700001	5731280	IDO Seven D -säiliön avain IDO Seven D Cistern nyckel IDO Seven D Tank key	10,42	8,40	
	Z6206000001	5731172	IDO Seven D -jalkaluukku, mallit -10 ja -12 IDO Seven D Täcklucka för -10, -12 IDO Seven D Cover door for -10, -12	3,91	3,15	

IDO MOSAIK 4 & 2,5 | 1999 - 2008

Z64445 ②

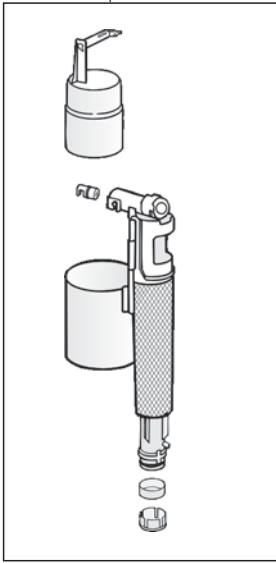

Z100010 ④

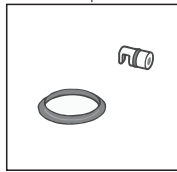

Z64410 ⑤

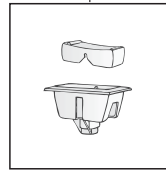



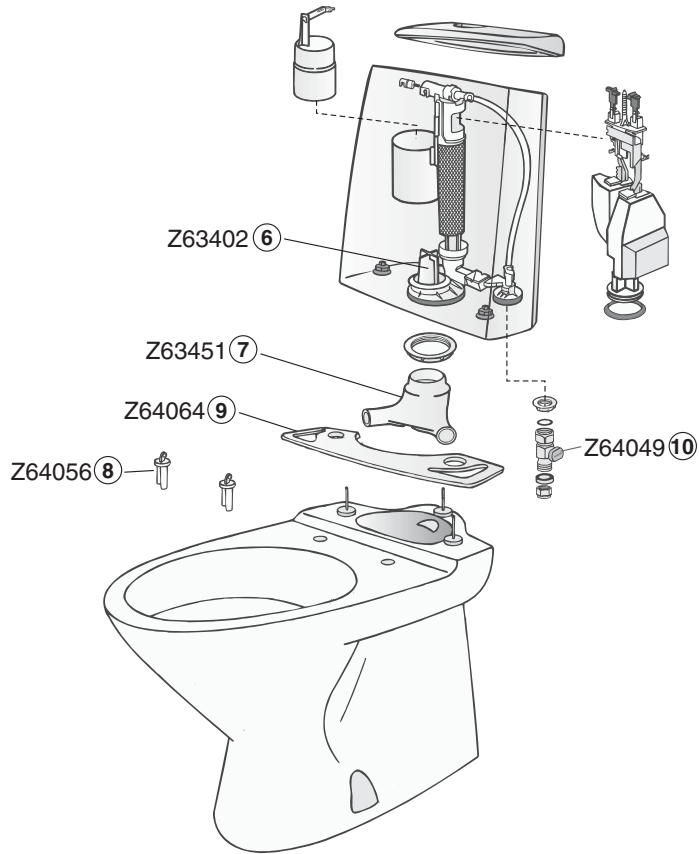
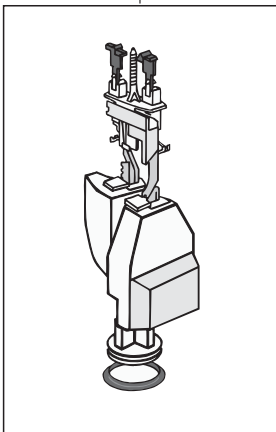



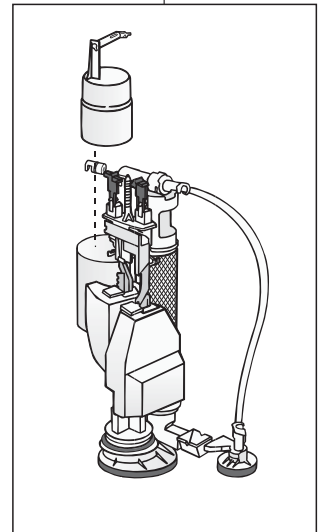







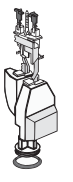









Z100009 ③









Z64441 ①

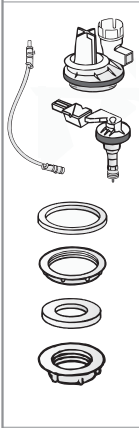

IDO MOSAIK 4 & 2,5 I 1999 - 2008

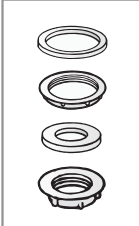
	Tuote Produkt Product	LVI- numero VVS- nummer	Nimike Benämning Item	Suositus- hinta Riktpris Price 24 % euro	Suositus- hinta Riktpris Price 0 % euro	EAN
①	 Z6444100001	5731187	Venttiisarja, täydellinen Ventil, komplett Valve kit complete	97,70	78,75	 6441612913622661
②	 Z6444500001	5731186	Uimuriventtiisarja, täydellinen Reparationssats för flottörventil Float valve kit complete	52,10	42,00	 6441612913622591
③	 Z1000090001	5731185	Huhteluventtiisarja, täydellinen Reparationssats för utloppsventil Flush valve kit complete	52,10	42,00	 6441612913622421
④	 Z1000100001	5731234	Tiivisteventtiili + mäntä Ventilpackning + kägla Valve sealing + piston	6,50	5,25	 6441612913622841
⑤	 Z6441000001	5731226	Painike Tryckknappssats Push button kit	22,10	17,85	 6441612913630271
⑥	 Z6340200001	5731188	Istukkaventtiili ilman mutteria Ventilsäte exkl. mutter Valve seat without nut	6,50	5,25	 6441612913622731
⑦	 Z6345100001	5731198	Vedenjakaja -70,-71 Spolrör -70,-71 Water distributor -70,-71	7,80	6,30	 6441612913623341
⑧	 Z6405600001	5731245	Saranat pehmeä kansi 91130 Gängledssats mjukits 91130 Hinges for soft seat 91130	9,10	7,35	 6441612913631191
⑨	 Z6406400001	5731227	Säiliötiiviste Cisternpackning Cistern sealing	15,60	12,60	 6441612913630341
⑩	 Z6404900001	5731207	Sulkuventtiili, kaikki mallit Avstängningsventil, alla modeller Stop valve, all models	22,10	17,85	 6441612913623321
	 Z6400100001	5731209	Tuloputken liitin 10 mm Koppling för inloppsrör 10 mm Coupling for inlet pipe 10 mm	24,80	20,00	 6441612913623561
	 Z6300100001	5731211	Tuloputken liitin 12 mm Koppling för inloppsrör 12 mm Coupling for inlet pipe 12 mm	6,50	5,25	 6441612913625631







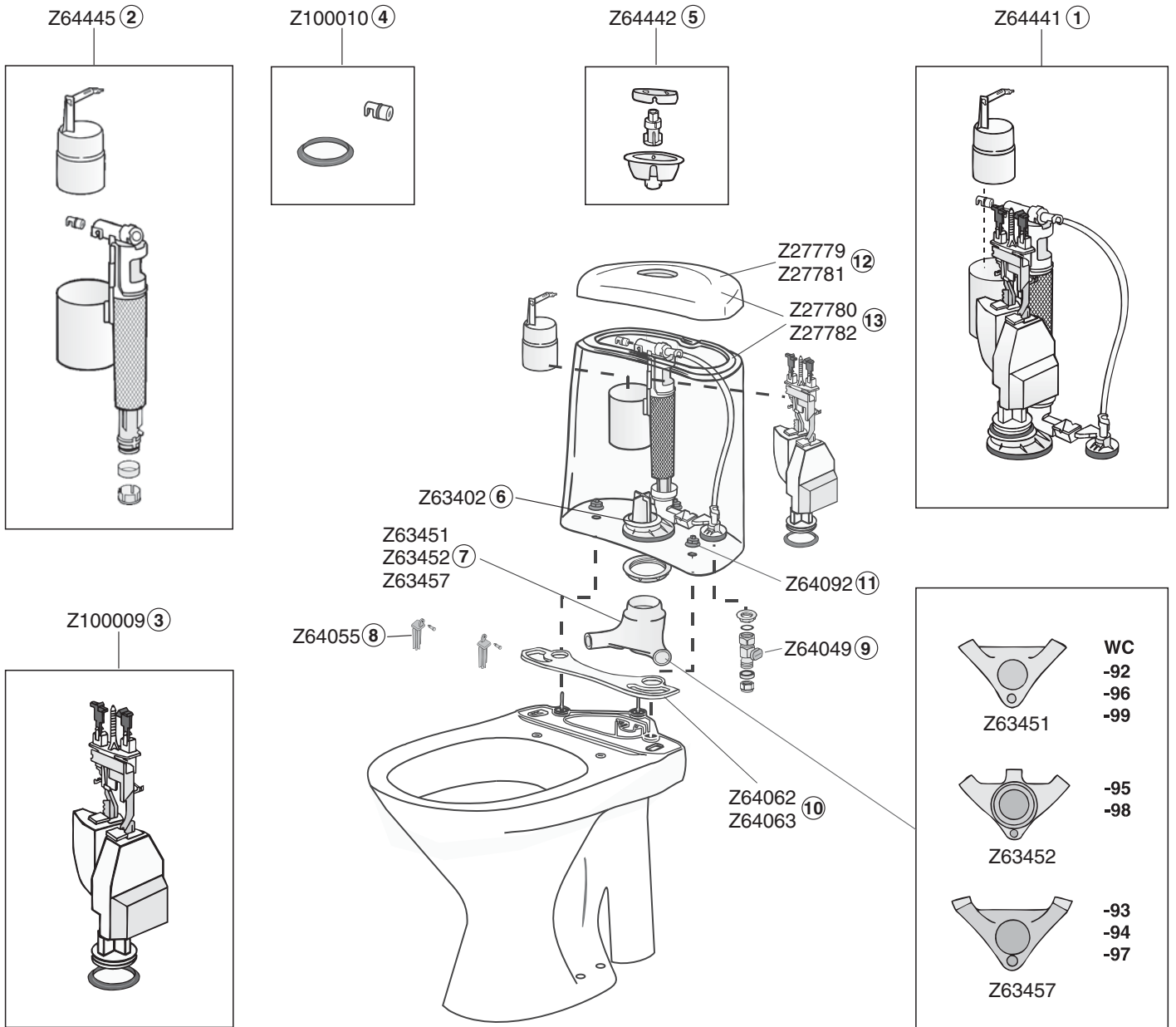







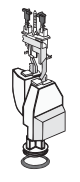







IDO MOSAIK 4 & 2,5 l 1999 - 2008

	Tuote Produkt Product	LVI- numero VVS- nummer	Nimike Benämning Item	Suositus- hinta Riktpris Price 24 % euro	Suositus- hinta Riktpris Price 0 % euro	EAN
	Z100020001	5731287	IDO Mosaik pohjaistukan, tuloputken ja tuloveden läpiviennin korjaussarja IDO Mosaik reparationskit för ventilsåte, inloppsror och inkommande vatten IDO Mosaik reparation kit for valve seat, inlet pipe and inlet water	52,10	42,00	 644161291363744
	Z100021001	5731288	IDO Mosaik mutteri ja pohjaistukan tiiviste ja tuloputken tiiviste IDO Mosaik mutter och tätning för bottenventil och inlopp IDO Mosaik nut and sealing for flush valve and inlet	13,00	10,50	 6441612913637511
	Z640920001	5731195	Säiliön kiinnitysruuvit Cisternskruvar Cistern fixing screws	7,80	6,30	 6441612913623031
	Z100006001	5731173	IDO Trevi Säiliötyökalu IDO Trevi Cistern nyckel IDO Trevi Tank key	58,59	47,25	













IDOTREVI 4 & 2,5 l 1996...









IDO TREVI 4 & 2,5 l 1996...

	Tuote Produkt Product	LVI- numero VVS- nummer	Nimike Benämning Item	Suositus- hinta Riktpris Price 24 % euro	Suositus- hinta Riktpris Price 0 % euro	EAN	
1	 Z6444100001	5731187	Venttiisarja, täydellinen Ventil, komplett Valve kit complete	97,70	78,75	 6441612913622661	
2	 Z6444500001	5731186	Uimuriventtiisarja, täydellinen Reparationssats för flottörventil Float valve kit complete	52,10	42,00	 6441612913622591	
3	 Z1000090001	5731185	Huhteluenttiisarja, täydellinen Reparationssats för utloppsventil Flush valve kit complete	52,10	42,00	 6441612913622421	
4	 Z1000100001	5731234	Tiivisteventtiili + mäntä Ventilpackning + piston Valve sealing + piston	6,50	5,25	 6441612913622841	
5		Z6444200001	5731196	Painike, kromi, kaksoisuuhtelu Tryckknappsanordning, krom Push button, chrome, double flush	18,20	14,70	 6441612913623101
		Z6444201001	5731197	Painike, valkoinen, kaksoisuuhtelu Tryckknappsanordning, vit Push button, white, double flush	7,80	6,30	 6441612913623271
6	 Z6340200001	5731188	Istukkaventtiili ilman mutteria Ventilsäte exkl. mutter Valve seat without nut	6,50	5,25	 6441612913622731	
7		Z6345100001	5731198	Vedenjakaja -92, -96, -99 Spolrör -92, -96, -99 Water distributor -92, -96, -99	7,80	6,30	 6441612913623341
		Z6345200001	5731235	Vedenjakaja -95, -98 Spolrör -95, -98 Water distributor -95, -98	9,10	7,35	 6441612913623411
		Z6345700001	5731236	Vedenjakaja -93, -94, -97 Spolrör -93, -94, -97 Water distributor -93, -94, -97	7,80	6,30	 6441612913630581
8	 Z6405500001	5731237	Saranat pehmeä kansi 91260 Gängledssats mjüksits 91260 Hinges for soft seat 91260	9,10	7,35	 6441612913628911	
9	 Z6404900001	5731207	Sulkuventtiili, kaikki mallit Avstängningsventil, alla modeller Stop valve, all models	22,10	17,85	 6441612913625321	
10	 Z6406200001	5731189	Säiliötiiviste 92-94, -96, -97, -99, Basic Cisternpackning 92-94, -96, -97, -99, Basic Cistern sealing 92-94, -96, -97, -99, Basic	6,50	5,25	 6441612913622801	

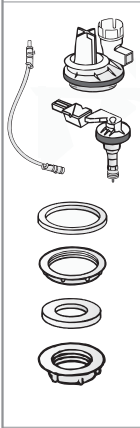
IDO TREVI 4 & 2,5 l 1996...

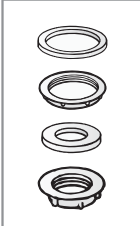
	Tuote Produkt Product	LVI- numero VVS- nummer	Nimike Benämning Item	Suositus- hinta Riktpris Price 24 % euro	Suositus- hinta Riktpris Price 0 % euro	EAN
10	Z6406300001	5731194	Säiliötiiviste -95, -98 Cisternpackning -95, -98 Cistern sealing -95, -98	6,50	5,25	 6441612913622971
11	Z6409200001	5731195	Säiliön kiinnitysruuvit Cisternskruvar Cistern fixing screws	7,80	6,30	 6441612913623031
12	Z2777901001	5650060	Säiliökansi, kaksoishuhtelu Cisternlock, dubbelspolning Cistern cover, double flush	58,60	47,25	 6441612913623891
	Z2778101001	5650062	Säiliökansi, kaksoishuhtelu -95, -98 Cisternlock, dubbelspolning -95, -98 Cistern cover, double flush -95, -98	58,60	47,25	 6441612913624021
13	Z2778001001	5650061	Säiliö, kaksoishuhtelu Cistern, dubbelspolning Cistern, double flush	128,90	103,95	 6441612913623961
	Z2778201001	5650063	Säiliö, kaksoishuhtelu -95, -98 Cistern, dubbelspolning -95, -98 Cistern, double flush -95, -98	128,90	103,95	 6441612913624191
	Z6400100001	5731209	Tuloputken liitin 10 mm Koppling för inloppsrör 10 mm Coupling for inlet pipe 10 mm	24,80	20,00	 6441612913625561
	Z6300100001	5731211	Tuloputken liitin 12 mm Koppling för inloppsrör 12 mm Coupling for inlet pipe 12 mm	6,50	5,25	 6441612913625631
	Z7109201001	5650068	WC-kulho -92 WC-skål -92 WC-bowl -92	253,90	204,75	 6441612912210511
	Z7109601001	5650075	WC-kulho -96 WC-skål -96 WC-bowl -96	253,90	204,75	 6441612913629071
	Z9159200001	5711118	Saranat, Trevi & Viva Gängsledssats för Trevi & Viva Hinges for Trevi and Viva	16,90	13,65	 6441612913623411
	Z9159300001	5731317	Saranat, Trevi, qr/kiinteä Gängsledssats för Trevi, qr/ff Hinges for Trevi, qr/ff	28,60	23,10	 6441612913011281

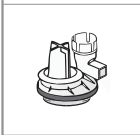
IDO TREVI 4 & 2,5 l 1996...





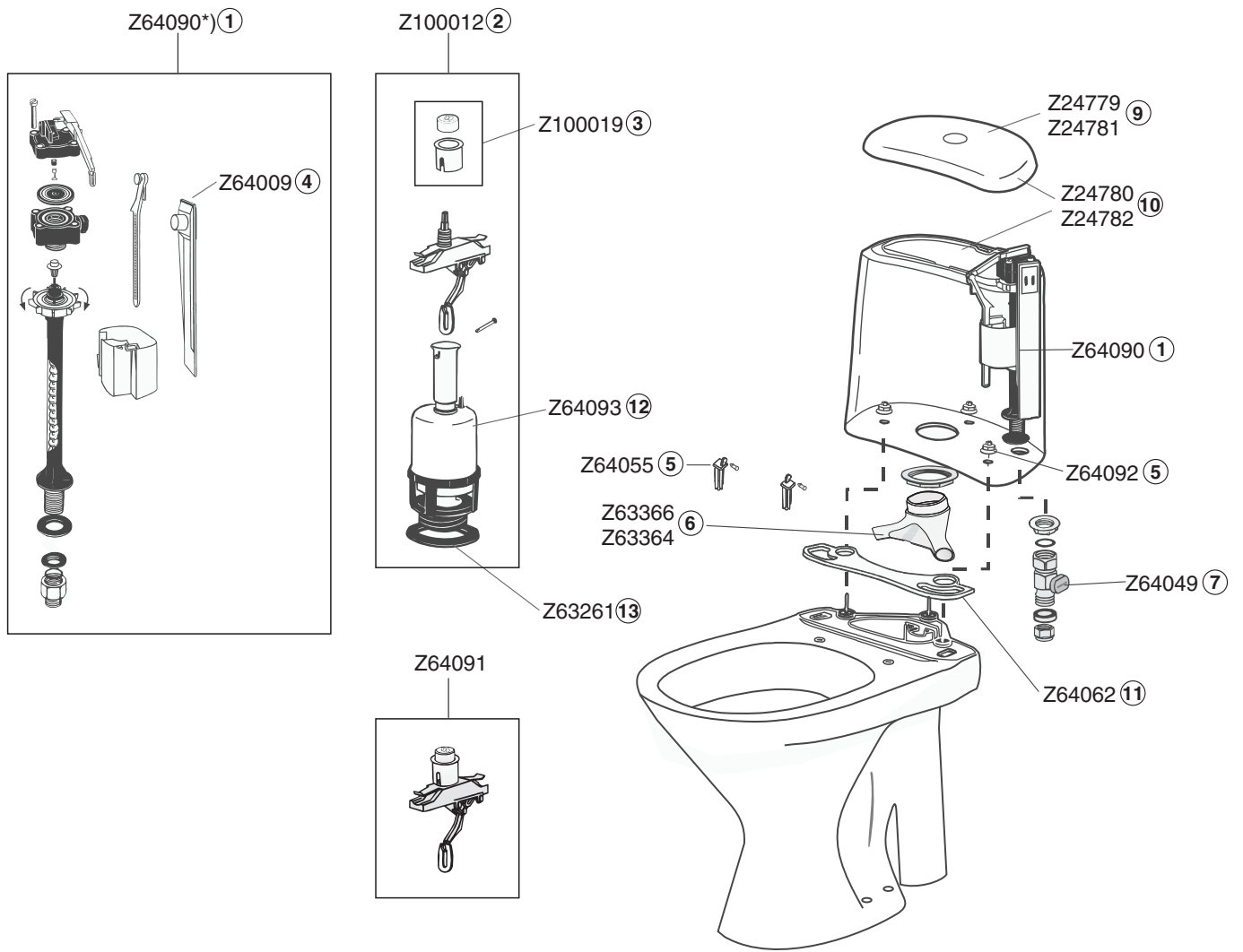















	Tuote Produkt Product	LVI- numero VVS- nummer	Nimike Benämning Item	Suositus- hinta Riktpris Price 24 % euro	Suositus- hinta Riktpris Price 0 % euro	EAN
	Z100020001	5731287	IDO Trevi pohjaistukan, tuloputken ja tuloveden läpiviennin korjaussarja IDO Trevi reparationskit för ventsäte, inloppsror och inkommande vatten IDO Trevi reparation kit for valve seat, inlet pipe and inlet water	52,10	42,00	 644161291363744
	Z100021001	5731288	IDO Trevi mutteri ja pohjaistukan tiiviste ja tuloputken tiiviste IDO Trevi mutter och tätning för bottenventil och inlopp IDO Trevi nut and sealing for flush valve and inlet	13,00	10,50	 6441612913637511
	Z634020001	5731188	Istukkaventtiili ilman mutteria Ventsäte exkl. mutter Valve seat without nut	6,50	5,25	 6441612913622731

IDOTREVI BASIC 4/6 I 1993...





















*) yksöishuhtelu • enkelspolning • single flush

IDO TREVI BASIC 4/6 I 1993...

	Tuote Produkt Product	LVI- numero VVS- nummer	Nimike Benämning Item	Suositus- hinta Riktpris Price 24 % euro	Suositus- hinta Riktpris Price 0 % euro	EAN
1	 Z640900001	5731238	Stop Nois III uimuriventtiili Flottörventil Stop Nois III Float valve Stop Nois III	52,10	42,00	 6441612913632251
2	 Z100012001	5731199	Tyhjennysventtiili + Painonappisarja Utloppsventil + Lyftanordning Flush valve + Push button kit	39,10	31,50	 6441612913633581
3	 Z100019001	5731308	Painonappi + holkki Tryckknapp + holk Pushbutton + cover nut	22,80	18,38	 6441612913633531
4	 Z6400900001	5731109	Laskuputki Utloppsör Outlet pipe	15,60	12,60	 6441612913101821
5	 Z6409200001	5731195	Säiliön kiinnitysruuvit Cisternskruvar Cistern fixing screws	7,80	6,30	 6441612913623031
6	 Z6336400001	5731202	Huhteluputki, wc -95, -98, Slim Spolrör, wc -95, -98, Slim Water distribution pipe, wc -95, -98, Slim	13,00	10,50	 6441612913624881
		Z6336600001	5731284	Huhteluputki, wc -92, -96 Spolrör wc, -92, -96 Water distributor, -92, -96	13,00	10,50
7	 Z6404900001	5731207	Sulkuventtiili, kaikki mallit Avstängningsventil, alla modeller Stop valve, all models	22,10	17,85	 6441612913625321
8	 Z6405500001	5731237	Saranat pehmeä kansi 91260 Gängledssats mjukits 91260 Hinges for soft seat 91260	9,10	7,35	 6441612913628911
9	 Z2477901001	5650064	Säiliökansi, yksöishuhtelu Cisternlock, enkelspolning Cistern cover, single flush	58,60	47,25	 6441612913624261
		Z2478101001	5650066	Säiliökansi, yksöishuhtelu -95, -98 Cisternlock, enkelspolning -95, -98 Cistern cover, single flush -95, -98	58,60	47,25
10	 Z2478001001	5650065	Säiliö, yksöishuhtelu Cistern, enkelspolning Cistern, single flush	128,90	103,95	 6441612913624331
		Z2478201001	5650067	Säiliö, yksöishuhtelu -95, -98 Cistern, enkelspolning -95, -98 Cistern, single flush -95, -98	128,90	103,95

IDO TREVI BASIC 4/6 l 1993...

	Tuote Produkt Product	LVI- numero VVS- nummer	Nimike Benämning Item	Suositus- hinta Riktpris Price 24 % euro	Suositus- hinta Riktpris Price 0 % euro	EAN	
	Z6406200001	5731189	Säiliöttiiviste 92-94, -96, -97, -99, Basic	6,50	5,25	 6 44 16 12 91 36 22 80	
			Cisternpackning 92-94, -96, -97, -99, Basic				
			Cistern sealing 92-94, -96, -97, -99, Basic				
	Z6409300001	5731309	Tyhjennysventtiili 4/6 l	58,60	47,25	 6 44 16 12 91 31 04 34	
			Utloppsventil 4/6 l				
			Flush valve 4/6 l				
	Z6326100001	5731233	Pohjaistukan tiiviste	3,90	3,15	 6 44 16 12 91 36 28 77	
			Tätning för ventsäte				
			Valve seat sealing				
	Z6402000001	5731310	Sulkulevy	9,10	7,35	 6 44 16 12 91 36 39 59	
			Sealing kit				
			Ventiltätning				
	Z6402100001	5731311	Täyttöventtiili korjaussarja	10,40	8,40	 6 44 16 12 91 36 39 66	
			Reparationssats för flottörventil				
			Repair set float valve				
	Z100015001	5731201	Tiivistesarja	10,40	8,40	 6 44 16 12 91 36 23 72	
			Sealing kit				
			Packningssats				
	Z6400100001	5731209	Tuloputken liitin 10 mm	24,80	20,00	 6 44 16 12 91 36 25 56	
			Koppling för inloppsrör 10 mm				
			Coupling for inlet pipe 10 mm				
	Z6300100001	5731211	Tuloputken liitin 12 mm	6,50	5,25	 6 44 16 12 91 36 25 63	
							Koppling för inloppsrör 12 mm
							Coupling for inlet pipe 12 mm
	Z7109201001	5650068	WC-kulho -92	253,90	204,75	 6 44 16 12 91 22 10 51	
			WC-skål -92				
			WC-bowl -92				
	Z7109601001	5650075	WC-kulho -96	253,90	204,75	 6 44 16 12 91 36 29 07	
			WC-skål -96				
			WC-bowl -96				

IDO ANIARA 6 I 1980 - 1996, 4/6 I 1993 - 2007



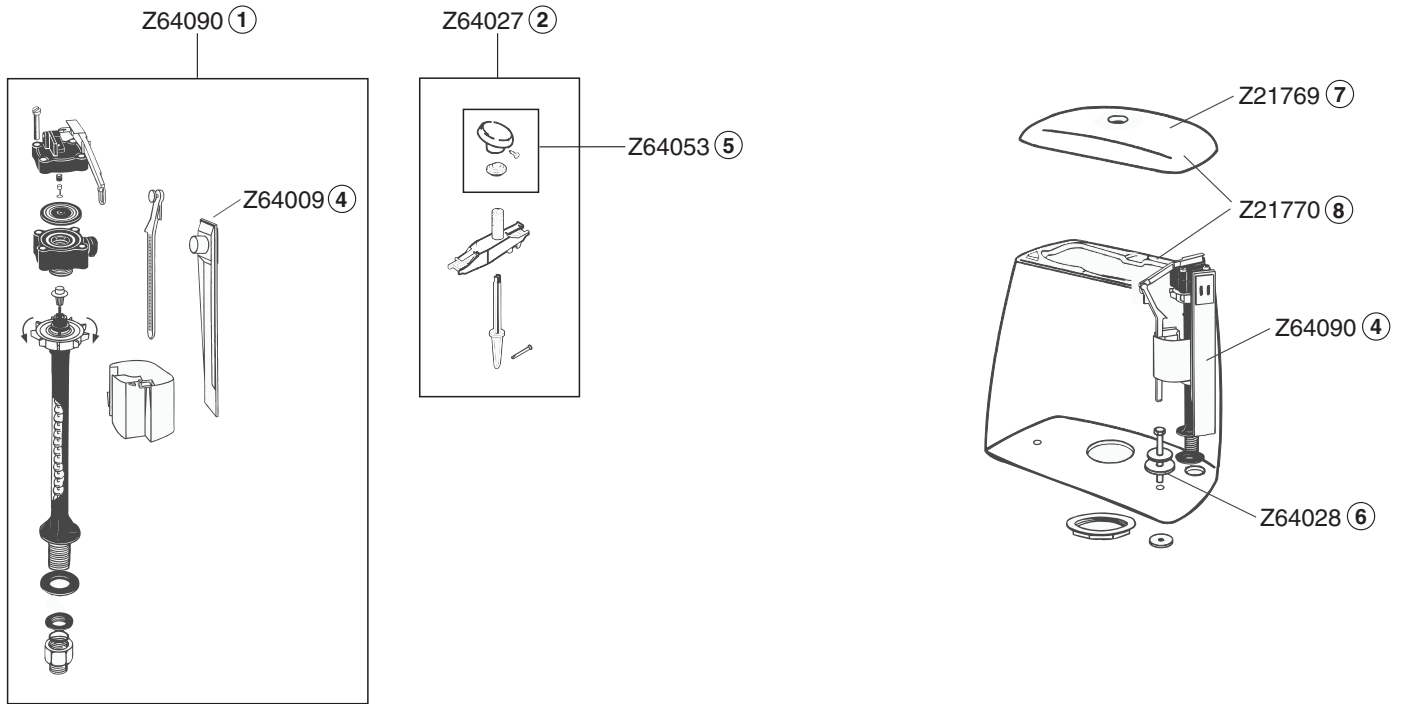



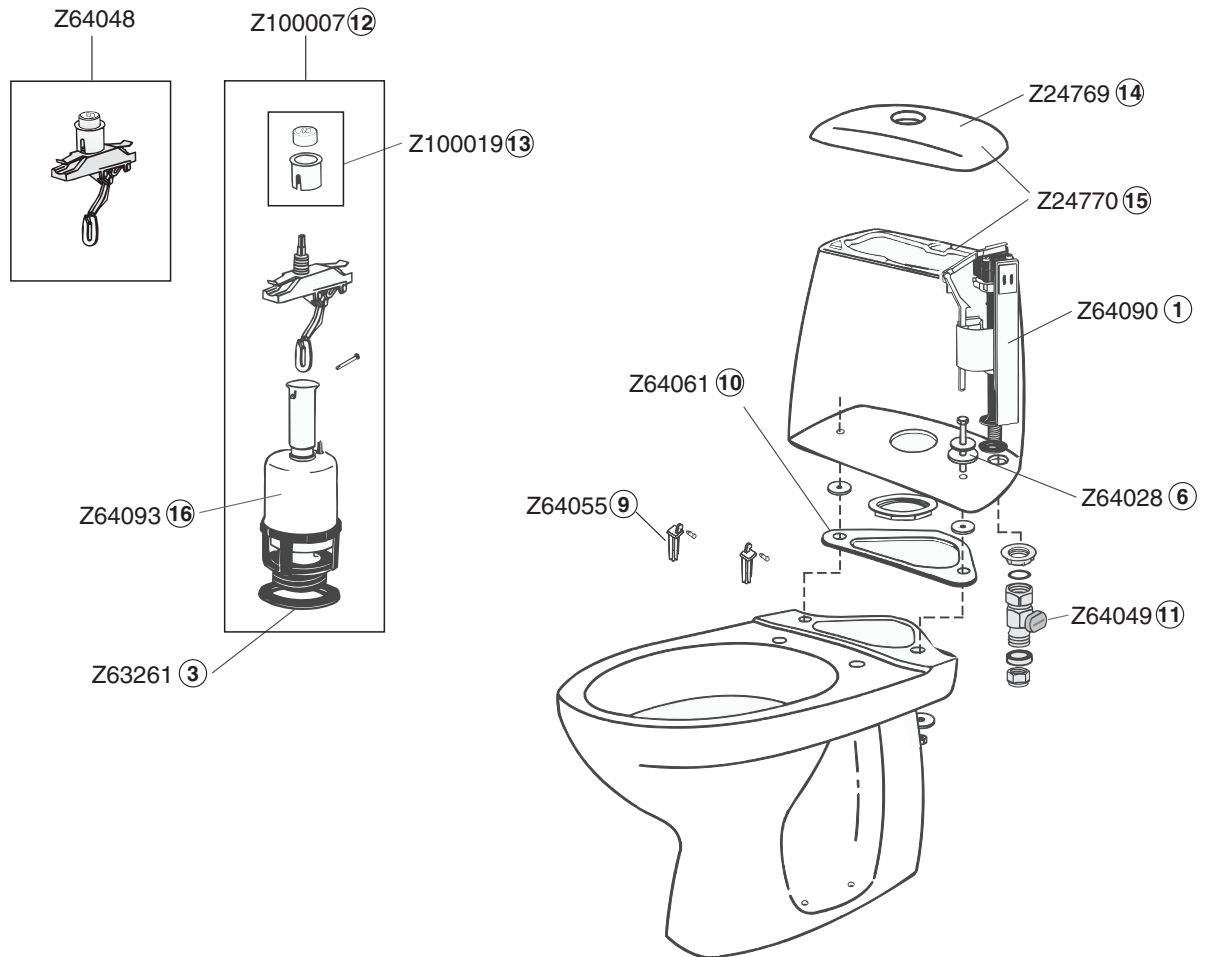





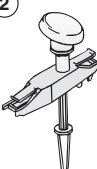





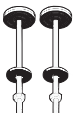

Vetonupilla • Med lyftknopp • With pull knob



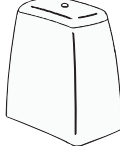























Painonapilla • Med tryckknapp • With push button



IDO ANIARA 6 I 1980 - 1996, 4/6 I 1993 - 2007

	Tuote Produkt Product	LVI- numero VVS- nummer	Nimike Benämning Item	Suositus- hinta Riktpris Price 24 % euro	Suositus- hinta Riktpris Price 0 % euro	EAN
1	 Z640900001	5731238	Stop Nois III uimuriventtiili Flottörventil Stop Nois III Float valve Stop Nois III	52,10	42,00	 6441612913632251
2	 Z640270001	5731180	Nostolaite Lyftanordning Lifting mechanism	32,60	26,25	 6441612913621741
3	 Z632610001	5731233	Pohjaistukan tiiviste Tätning för ventilsåte Valve seat sealing	3,90	3,15	 6441612913628771
4	 Z640090001	5731109	Laskuputki Utloppsör Outlet pipe	15,60	12,60	 6441612913101821
5	 Z640530001	5731302	Nuppi ruuveineen Knopp med skruv Knob with screw	14,30	11,55	 6441612913639041
6	 Z640280001	5731181	Säiliön kiinnitysruuvit Cisternskruvar Cistern fixing screws	14,30	11,55	 6441612913621811
7	 Z2176901001	5650107	Säiliökansi, vetonuppi Cisternlock lyftspolning Cistern cover, pull knob	58,60	47,25	 6441612913634611
8	 Z2177001001	5731184	Säiliö, vetonuppi Cistern med lock lyftspolning Cistern, pull knob	128,90	103,95	 6441612913622111
9	 Z640550001	5731237	Saranat pehmeä kansi 91260 Gängledssats mjüksits 91260 Hinges for soft seat 91260	9,10	7,35	 6441612913628911
10	 Z640610001	5731183	Säiliötiiviste Cisternpackning Cistern sealing	6,50	5,25	 6441612913622041

IDO ANIARA 6 l 1980 - 1996, 4/6 l 1993 - 2007

	Tuote Produkt Product	LVI- numero VVS- nummer	Nimike Benämning Item	Suositus- hinta Riktpris Price 24 % euro	Suositus- hinta Riktpris Price 0 % euro	EAN
11	 Z6404900001	5731207	Sulkuventtiili Avstängningsventil Stop valve	22,10	17,85	 6441612913625321
12	 Z100007001	5731182	Tyhjennysventtiili + Painonappisarja Utloppsventil + Tryckknappssats Flush valve + Push button kit	80,60	65,00	 6441612913621981
13	 Z100019001	5731308	Painonappi + holkki Tryckknapp + holk Pushbutton + cover nut	22,80	18,38	 6441612913639351
14	 Z2476901001	5650058	Säiliökansi, painonappi Cisternlock tryckspolning Cisterncover, pushbutton	58,60	47,25	 6441612913622281
15	 Z2477001001	5650059	Säiliö, painonappi Cistern med lock tryckspolning Cistern, pushbutton	128,90	103,95	 644161291362351
16	 Z6409300001	5731309	Tyhjennysventtiili 4/6 l Utloppsventil 4/6 l Flush valve 4/6 l	58,60	47,25	 6441612913104341
	 Z6404800001	5731304	Ido Aniara Painomekanismi Ido Aniara Tryckanordning Ido Aniara Push device	36,50	29,40	 6441612913639281
	 Z6402000001	5731310	Sulkulevy Sealing kit Ventiltätning	9,10	7,35	 6441612913639591
	 Z6402100001	5731311	Täyttöventtiili korjaussarja Reparationsssats för flottörventil Repair set float valve	10,40	8,40	 6441612913639661
	 Z100015001	5731201	Tiivistesarja Sealing kit Packingssats	10,40	8,40	 6441612913623721
	 Z6400100001	5731209	Tuloputken liitin 10 mm Koppling för inloppsrör 10 mm Coupling for inlet pipe 10 mm	24,80	20,00	 6441612913625561
	 Z6300100001	5731211	Tuloputken liitin 12 mm Koppling för inloppsrör 12 mm Coupling for inlet pipe 12 mm	6,50	5,25	 6441612913625631



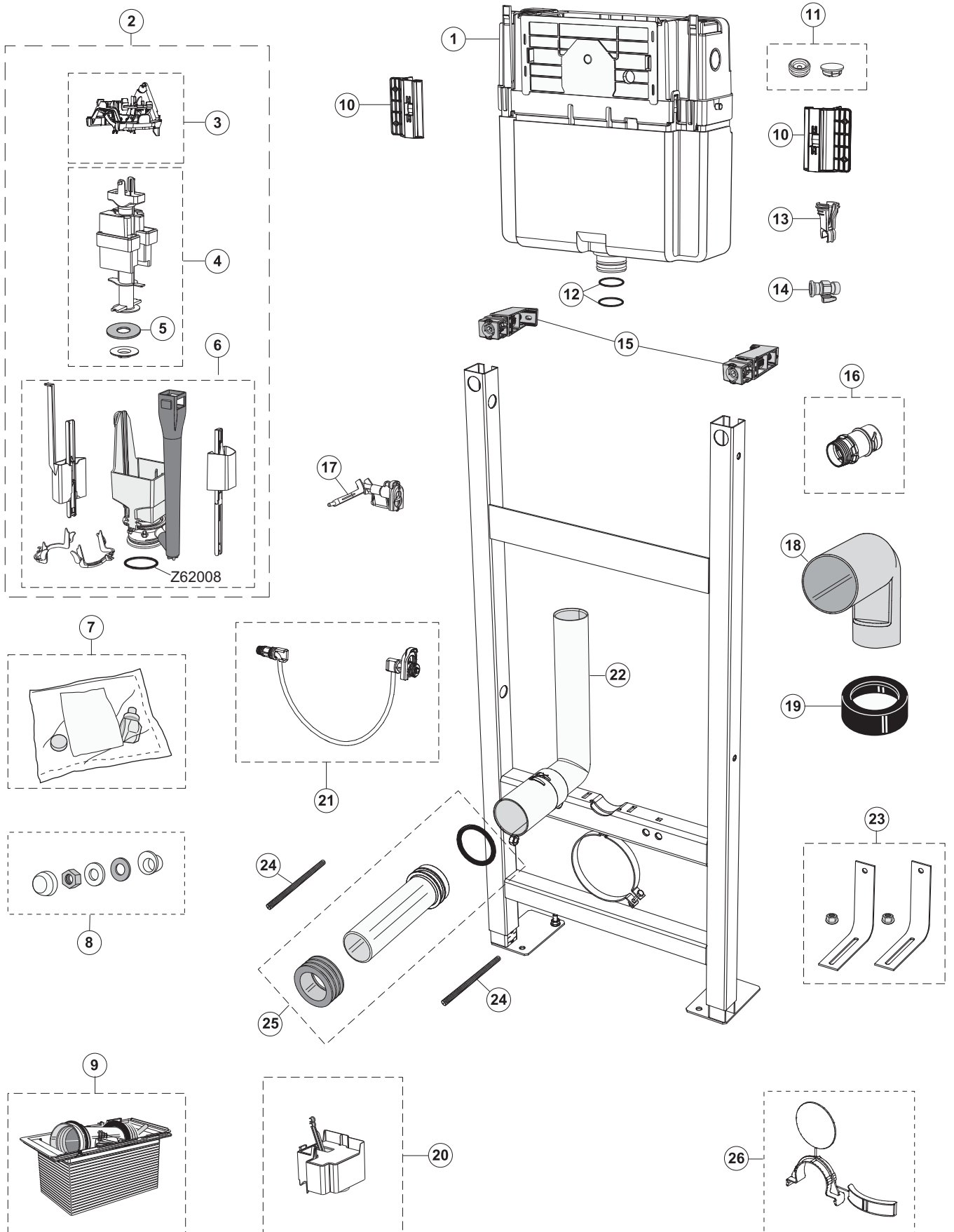



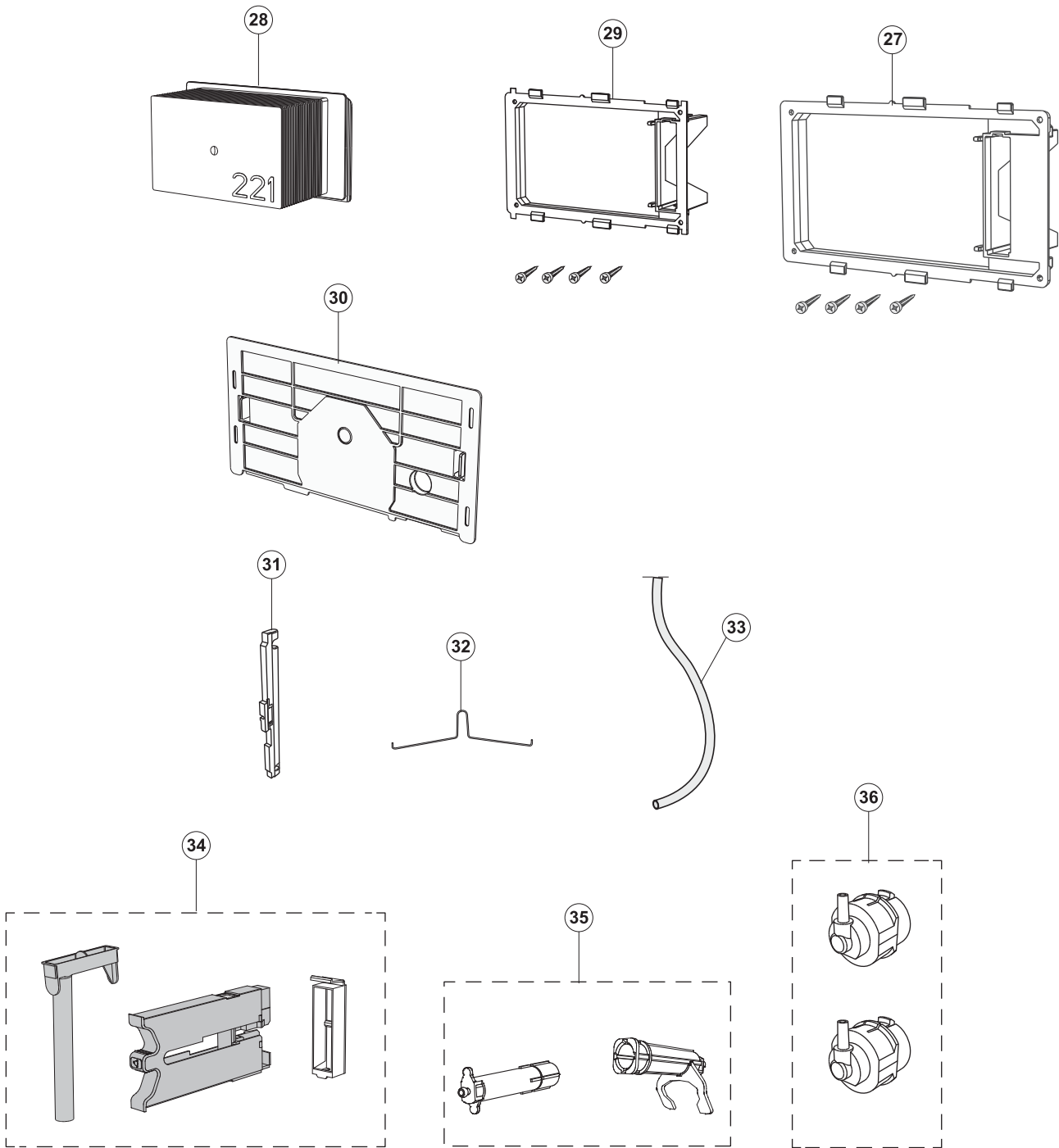



















IDO SEVEN D -seinä-wc:n asennusteline • vägg-wc fixtur • wall-wc fixture 91372



IDO SEVEN D

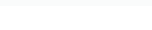

IDO SEVEN D

	Tuote Produkt Product	LVI- numero VVS- nummer	Nimike Benämning Item	Suositus- hinta Riktpris Price 24 % euro	Suositus- hinta Riktpris Price 0 % euro	EAN
①	Z6926800001	5751137	Säiliö, täydellinen • Inbyggnadscistern, komplett • Cistern, complete	83,30	67,20	 6441612913615731
②	Z6925800001	5751138	Huuhtelumekanismi, täydellinen • Fixtur spolmekanism, komplett Flushing device, complete	32,60	26,25	 6441612913615801
③	Z6925700001	5751139	Silta täydellinen • Fixtur brygga, komplett • Bridge, complete	16,90	13,65	 6441612913615971
④	Z6926000001	5731278	Ylivuotoputki • Fixtur bräddrör • Overflow tube	15,60	12,60	 6441612913636211
⑤	Z6200900001	5731242	Pohjaventtiilin tiiviste • Bottenventilens tätning • Flush valve sealing	3,90	3,15	 6441612913629521
⑥	Z6925900001	5751141	Huuhtelujalusta • Fixtur spolstativ komplett • Flushing frame complete	20,80	16,80	 6441612913616031
⑦	Z6926400001	5751155	Kytentäsarja, pex D15/16 • Fixtur monteringsatts för pex D15/16 Connection kit pex D15/16	19,50	15,75	 6441612913617331
⑧	Z6925300001	5751157	Asennussarja wc-kulholle, 2 kpl • Fixtur montsats för wc-skål, 2 st Assembly kit for wc-bowl, 2 pcs	7,80	6,30	 6441612913617401
⑨	Z6925600001	5751158	Asennussarja • Fixtur montsats • Assembly kit	62,00	50,00	 6441612913617571
⑩	Z6926100001	5751142	Säiliönkiinnitys, 2 kpl • Fixtur cisternfäste, 2 st • Cistern fixation, 2 pcs	5,20	4,20	 6441612913616101
⑪	Z6923900001	5731285	Peitekansi läpivientiä varten • Fixtur täcklock genomför Cover for feedthrough	6,50	5,25	 6441612913637201
⑫	Z6923300001	5731279	Säiliön o-tiiviste 2 kpl • Fixtur o-ring för cist/spolr, 2 st O-ring for cistern/flush pipe 2 pcs	5,20	4,20	 6441612913636381
⑬	Z6920000001	5751143	Sulkuventtiilin kiinn. • Fixtur håll för avstängningsventil • Stop valve fixation	2,60	2,10	 6441612913616271
⑭	Z500009001	5731275	Sulkuventtiili, täydellinen • Fixtur avstängningsventil, komplett Stop valve, complete	26,00	21,00	 6441612913633151
⑮	Z6922700001	5751145	Ylempi seinäkiinnike, seinäasennus, 2 kpl • Fixtur övre väggfäster, 2 st Upper wall fixation, 2 pcs	15,60	12,60	 6441612913616411
⑯	Z6925500001	5751147	Suojaputkenkiinn.25/28, 2 kpl • Fixtur fixering för skyddsror, 2 st Pipe-in-pipe fixation 25/28, 2 pcs	10,40	8,40	 6441612913616581
⑰	Z6928000001	5731254	Täyttöventtiili, täydellinen • Fixtur inloppsventil, komplett Inlet valve, complete	7,80	6,30	 6441612913632871
⑱	6926701001	5711436	Seinäas. viemäriputki, 90° • Fixtur avloppsror 90° grader Waste pipe 90° waist	19,00	15,34	 6441612913626481
⑲	Z6924300001	5731256	Viemäriputken tiiviste • Fixtur avloppmanschet • Waste pipe sealing	9,92	8,00	 6441612913633001
⑳	Z6927700001	5751148	Uimurikuppi, täydellinen • Inloppsflottör, komplett • Inlet float, complete	10,40	8,40	 6441612913616651
㉑	Z6922100001	5751149	Seinäas. pex-letku, täydellinen • Fixtur inloppslangr, komplett Pex-hose, complete	19,50	15,75	 6441612913616721
㉒	Z6920300001	5751150	Huuhteluputki, korkea • Fixtur spolrör för hög fix • Flush pipe for high frame	14,30	11,55	 6441612913616891
㉓	Z6922900001	5751151	Alempi seinäkiinnike, seinäasennus, 2 kpl • Fixtur nedre väggfäste, 2 st Lower wall fixation, 2 pcs	15,60	12,60	 6441612913616961
㉔	Z6923600001	5751152	Wc-pultti, 2 kpl • Fixtur upphöjd bult för wc-skål, 2 st • Wc-bolt, 2 pcs	5,20	4,20	 6441612913617021
㉕	Z100000001	5751153	Wc-adaptteri tiivisteineen • Fixtur wc-adapt m packning Wc-adapter with sealings	9,10	7,35	 6441612913617191
㉖	Z6920600001	5751154	Peitekansi, pidike ja täytepala 110 mm viemäriputkelle • Fixtur täcklock, klämma och tillägsbit för 110 mm avlopp • Spacer, clip and cover	3,90	3,15	 6441612913617261
㉗	Z6920200001	5751159	Kiinnitysketys 230x115 mm • Ram för stor spolknapp 230x115 mm Counter plate 230x115 mm	7,80	6,30	 6441612913617641
㉘	Z6925100001	5751167	Huoltotunneli 221 • Fixtur servicetunnel 221 • Service tunnel 221	11,70	9,45	 6441612913618321



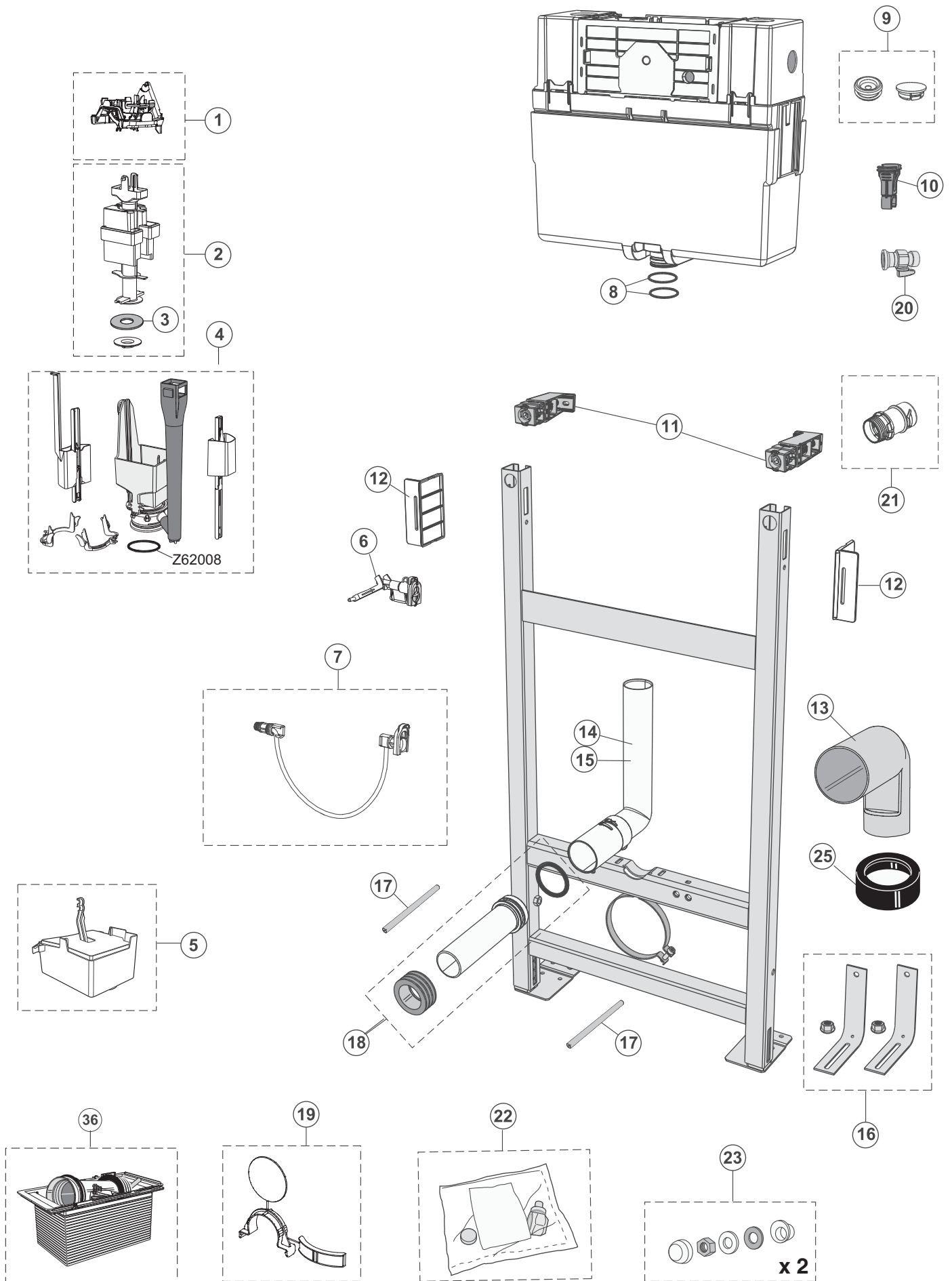



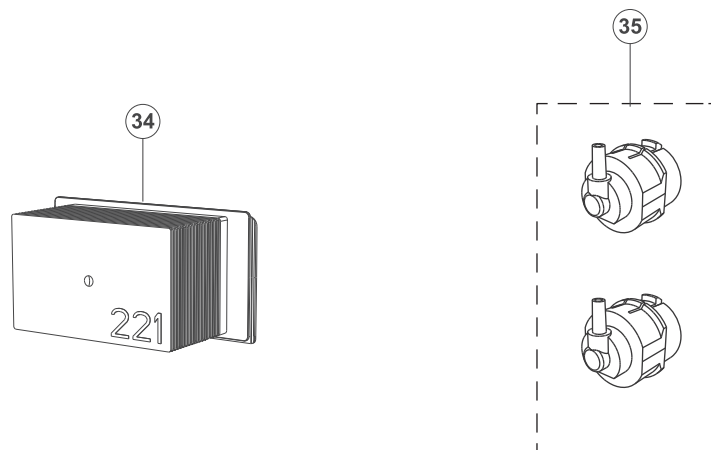
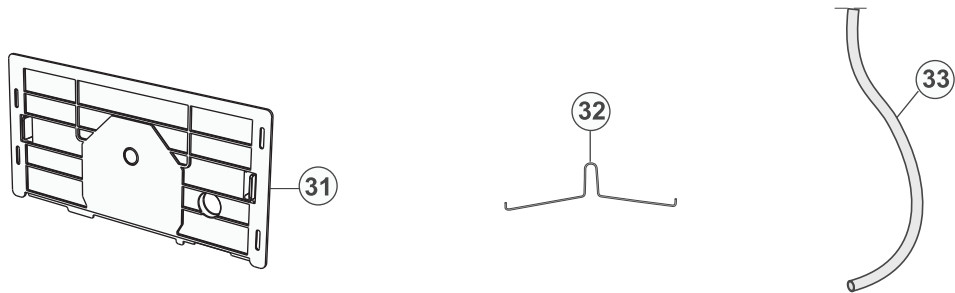
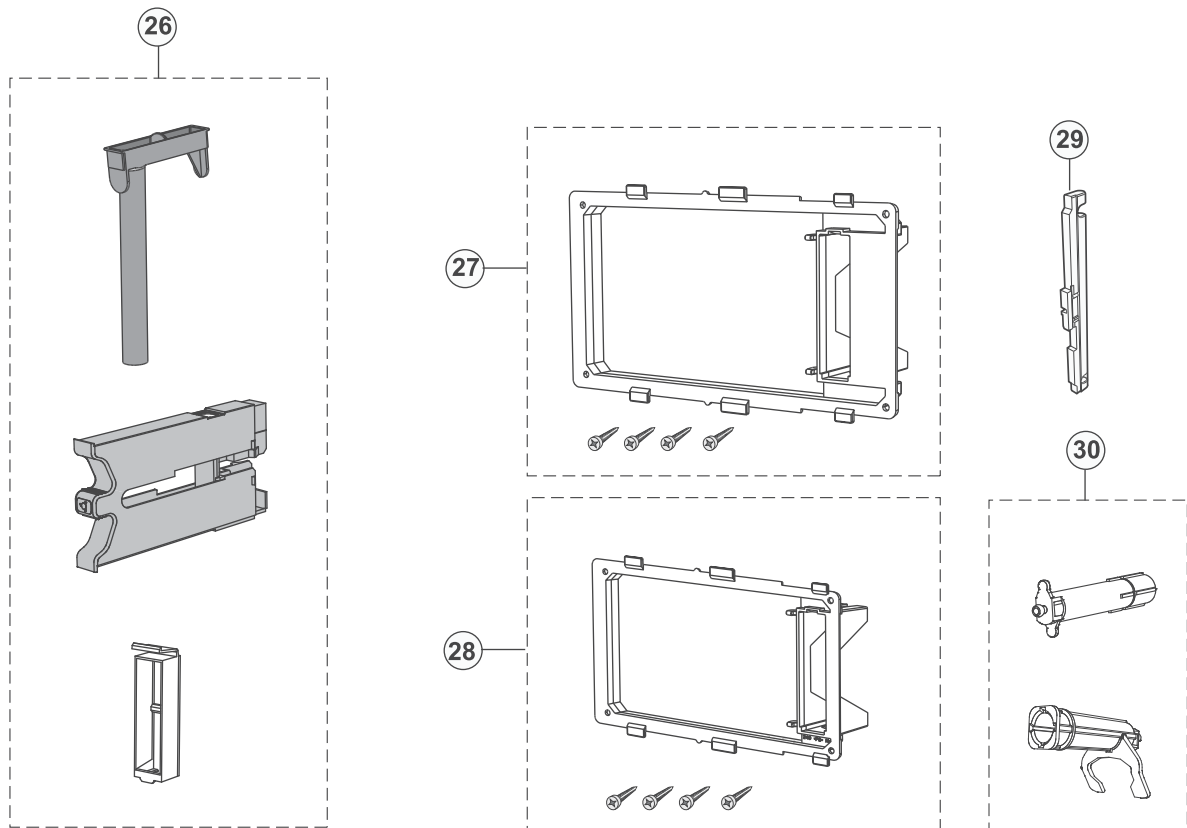





















ICM - Teline • Fixtur • Fixture 91370, 91371, 91375, 91376



ICM - Painikkeet • Tryckknappar • Pushbuttons 69080, 69081, 69082







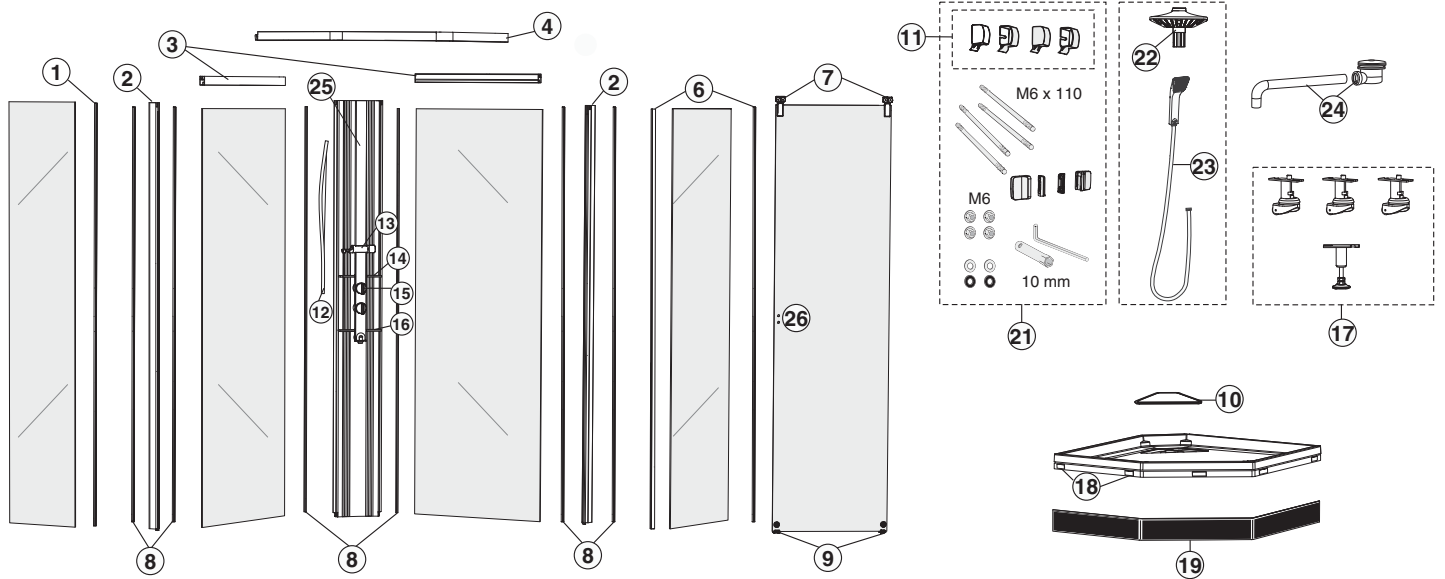









ICM

	Tuote Produkt Product	LVI- numero VVS- nummer	Nimike Benämning Item	Suositus- hinta Riktpris Price 24 % euro	Suositus- hinta Riktpris Price 0 % euro	EAN
①	Z6925700001	5751139	Silta täydellinen • Fixtur brygga, komplett • Bridge, complete	16,90	13,65	 644161293615971
②	Z6926000001	5731278	Ylivuotoputki • Fixtur bräddrör • Overflow tube	15,60	12,60	 644161293636211
③	Z6200900001	5731242	Pohjaventtiilin tiiviste • Bottenventilens tätning • Flush valve sealing	3,90	3,15	 644161293629521
④	Z6922200001	5731313	Huuhtelujalusta, täydellinen • Spolmekanism, komplett Spooling stand, complete	26,00	21,00	 644161293643141
⑤	Z6928100001	5731274	Uimurikuppi, täydellinen • Inloppsflottör, komplett • Inlet float, complete	27,30	22,05	 644161293635081
⑥	Z6928000001	5731254	Täyttöventtiili, täydellinen • Fixtur inloppsventil, komplett Inlet valve, complete	7,80	6,30	 644161293632871
⑦	Z6922100001	5751149	Seinäas. pex-letku, täydellinen • Fixtur inloppslang, komplett Pex-hose, complete	19,50	15,75	 644161293616721
⑧	Z6923300001	5731279	Säilön o-tiiviste, 2 kpl • Fixtur o-ring för cist/spolr, 2 st O-ring for cistern/flush pipe, 2 pcs	5,20	4,20	 644161293636381
⑨	Z6923900001	5731285	Peitekansi läpivientiä varten • Fixtur täcklock genomför Cover for feedthrough	6,50	5,25	 644161293637201
⑩	Z6920000001	5751143	Sulkuventtiilin kiinnike, 2 kpl • Fixtur håll för avstängningsventil, 2 st Stop valve fixation, 2 pcs	2,60	2,10	 644161293616271
⑪	Z6922700001	5751145	Ylempi seinäkiinnike, seinäasennus, 2 kpl • Fixtur övre väggfäste, 2 st Upper wall fixation, 2 pcs	15,60	12,60	 644161293616411
⑫	Z6922600001	5751170	Säiliö kiinnitys, 2 kpl • Cisternfixering, 2 st • Cistern fixation, 2 pcs	3,90	3,15	 644161293618631
⑬	6926701001	5711436	Seinäas. viemäriputki, 90° • Fixtur avloppsrör 90° grader Waste pipe 90° waist	19,00	15,34	 644161293626481
⑭	Z6920400001	5751171	Huuhteluputki, matala • Spolrör för låg fixtur Flush pipe for low frame	11,64	9,39	 644161293618701
⑮	Z6920300001	5751150	Huuhteluputki, korkea • Fixtur spolrör för hög fix • Flush pipe for high frame	14,30	11,55	 644161293616891
⑯	Z6922900001	5751151	Alempi seinäkiinnike, seinäasennus, 2 kpl • Fixtur nedre väggfäste, 2 st Lower wall fixation, 2 pcs	15,60	12,60	 644161293616961
⑰	Z6923600001	5751152	Wc-pultti, 2 kpl • Wc-bult, 2 st • Wc-bolt, 2 pcs	5,20	4,20	 644161293617021
⑱	Z100000001	5751153	Wc-adaptteri tiivisteineen • Wc adapter med packningar Wc-adapter with sealings	9,10	7,35	 644161293617191
⑲	Z6920600001	5751154	Peitekansi ja pidike • Fixtur täcklock och klämma • Spacer, clip and cover	3,90	3,15	 644161293617261
⑳	Z500009001	5731275	Sulkuventtiili, täydellinen • Fixtur avstängningsventil, komplett Stop valve, complete	26,00	21,00	 644161293635151
㉑	Z6925500001	5751147	Suojaputkenkiinn. 25/28 • Fixering för skyddsror 25/28 Pipe-in-pipe fixation 25/28	10,40	8,40	 644161293616581
㉒	Z6926400001	5751155	Kytentäsarja, pex D15/16 • Fixtur montset f pex D15/16 Connection kit pex D15/16	19,50	15,75	 644161293617331
㉓	Z6925300001	5751157	Asennussarja wc-kulholle, 2 kpl • Fixtur montsats för wc-skål, 2 st Assembly kit for wc-bowl, 2 pcs	7,80	6,30	 644161293617401
㉕	Z6924300001	5731256	Viemäriputken tiiviste • Fixtur avloppmanschet • Waste pipe sealing	9,92	8,00	 644161293635001
㉖	Z6920900001	5751160	Annostel.detaljit, täydellinen • Fixtur dosdetalj f fresh wc Dosing details, complete	10,40	8,40	 644161293617711
㉗	Z6920200001	5751159	Kiinnityskehys 230x115 mm • Ram för stor spolknapp 230x115 mm Counter plate 230x115 mm	7,80	6,30	 644161293617641
㉘	Z6925000001	5731300	Painonapin kehys 190x115 mm • Fixtur fästram 190x115 mm Fixing frame 190x115 mm	9,10	7,35	 644161293638501
㉙	Z6921400001	5751163	Vandalismisuoja • Fixtur vandalsäkring • Protection against vandalism	3,90	3,15	 644161293617951

IDO SHOWERAMA - Suihkukaappi, Duschkabin, Shower cabin 8-5 (2011-)









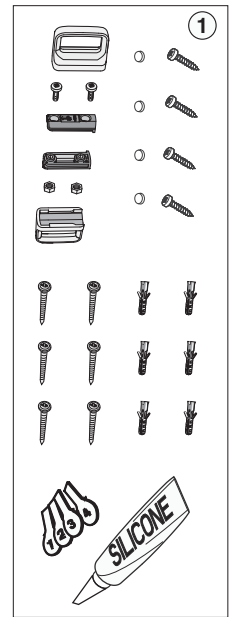
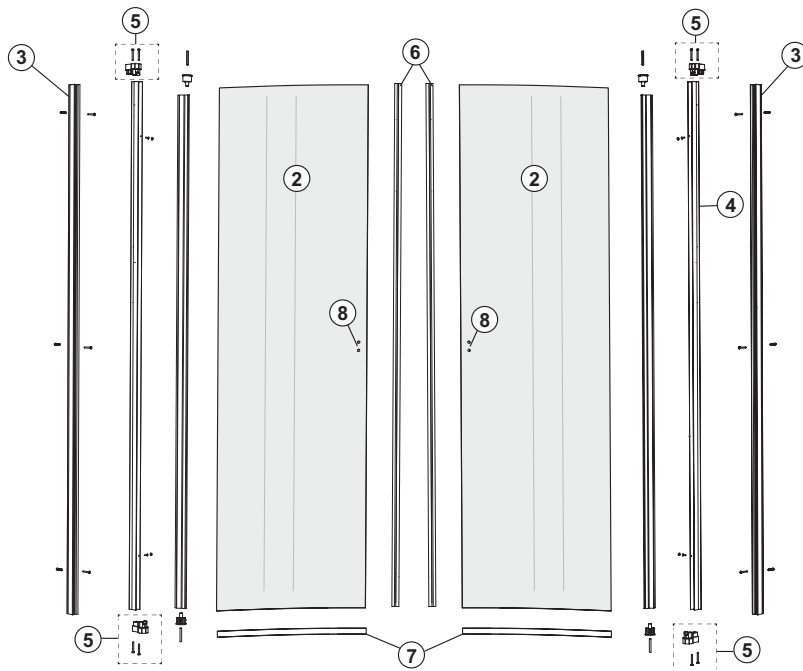

	Tuote Produkt Product	LVI- numero VVS- nummer	Nimike Benämning Item	Suositus- hinta Riktpris Price 24 % euro	Suositus- hinta Riktpris Price 0 % euro	EAN
①	Z0704861001	5841629	Ovitivistesarja täydellinen • Dörrtättningslist komplett set	43,00	34,65	
⑥			Door sealing kit, complete			
②	Z0700703001	5841693	Kulmaprofiili, valkoinen • Hörnprofil, vit • Corner profile, white	63,80	51,45	
	Z0700704001	5841694	Kulmaprofiili matala/valkoinen • Hörnprofil låg vit • Corner profile, low white	63,80	51,45	
③	Z0700534001	5841690	Takayläprofiili, täydellinen/valkoinen 800 mm • Överliggare, komplett/vit 800 mm	50,80	40,95	
	Z0700535001	5841691	Takayläprofiili, täydellinen/valkoinen 900 mm • Överliggare, komplett/vit 900 mm	50,80	40,95	
	Z0700536001	5841692	Takayläprofiili, täydellinen/valkoinen 1000 mm • Överliggare, komp./vit 1000 mm	50,80	40,95	
④	Z0700635001	5841684	Etuyläprofiili, täydellinen/valkoinen 800x900 mm • Överliggare, komp./vit 800x900 mm • Front top profile complete 800x900 mm	121,10	97,65	
	Z0700636001	5841685	Etuyläprofiili täydell./valk. 900x800 mm • Överliggare komp./vit 900x800 mm	121,10	97,65	
	Z0700637001	5841686	Etuyläprofiili täydell./valk. 900x900 mm • Överliggare komp./vit 900x900 mm	118,50	95,55	
	Z0700638001	5841687	Etuyläprofiili täydellinen/valkoinen 1000x1000 mm • Överliggare komplett/vit 1000x1000 mm • Front top profile complete/white 1000x1000 mm	123,70	99,75	
⑦	Z0705161001	5841634	Pyöräsarjapakkaus • Hjulupphängning komplett set • Wheel kit	46,90	37,80	
⑧	Z0702721001	5841695	Lasitiviste • U-profil • U-profile	5,20	4,20	
⑨	Z0705861001	5841633	Ohjuri, pari vas./oik. • Dörrstyrning komplett set • Steering	32,60	26,25	
⑩	Z0704431001	5841635	Viemärinkansi • Lock för avlopp • Drain cover	36,50	29,40	
⑫	Z0702506001	5841632	Valkoinen letku • Slang bakom pelare vit • White hose for 8-5 (behind pillar)	18,20	14,70	
⑬	Z0705030001	5841696	Käsisuihkupidike, täydellinen • Handduschhållare, komplet	27,30	22,05	
			Handshower holder, complete			
⑭	Z0702500001	5751136	Sekoittaja, täydellinen • Armatur för pelare komplett • Faucet, complete	260,40	210,00	

IDO SHOWERAMA - Suihkukaappi, Duschkabin, Shower cabin 8-5 (2011-)

	Tuote Produkt Product	LVI- numero VVS- nummer	Nimike Benämning Item	Suositus- hinta Riktpris Price 24 % euro	Suositus- hinta Riktpris Price 0 % euro	EAN
15	Z0702333001	5841697	Ylähyly, täydellinen • Hylla övre, komplett • Upper shelf, complete	75,50	60,90	 713941184490461
16	Z0702331001	5841698	Alahyly, täydellinen • Hylla nedre, komplett • Lower shelf, complete	75,50	60,90	 713941184490531
17	Z7110001	5841688	Altaan pyöräsarja, täydellinen • Hjul för kabinkar, komplett Wheel set for shower tray, complete	43,00	34,65	 713941184489571
18	Z0706420001	5841761	Etulevyn pidikkeet • Frontfästen till frontpanel, sats • Fixing set for front panel (3 mustaa, 3 valkoista, koossa 1000 x 1000 tarvitaan kaksi sarjaa) (3 svart + 3 vita, 1000 x 1000 två satser) (3 black + 3 white, 1000x1000 requires two sets)	11,70	9,45	 6441612913642911
19			Katso IDO Kylpyhuonekuvasto 2015 • Se katalog IDO Badrumskollektion 2015			
21	Z0705430001	5841627	Asennussarja • Monteringssats • Assembly kit	45,60	36,75	 713941184479051
22	Z0705540001	5841700	Sadesuihku, kromi • Toppdusch med regnmunstycke • Rain shower head	65,10	52,50	 713941184490771
23	Z0705535001	5841699	Käsिसuihku & letku, kromi • Hånddusch med slange, komplett Handshower with hose	45,60	36,75	 713941184490601
24	Z0705630001	5841630	Vesilukko+ poistoputki • Utloppssats, komplett • Outlet set	32,60	26,25	 713941184479361
25	Z0700905001	5841724	Suihkutanko, mattahoipa • Rail, silver • Rail, silver	85,90	69,30	 713941184495581
	Z0700903001	5841680	Suihkutanko, valkoinen • Rail, vit • Rail, white	63,80	51,45	 713941184488651
26	Z0700805001	5841779	Kahvan pidike • Handtagsfäste • Handle holder	21,22	17,25	 7139411844510871
	Z200026001	5841780	Lasinpidike, täydellinen • Glasanhåll, komplett (7 delar) Glass stop, complete	40,90	33,00	 7139411844513911
	Z200027001	5841777	Tassut istuimelle (4 kpl) • Tassar till pall, sats (4 st) • Pads for seat, 4 pcs	7,38	6,00	 7139411844508991
	Z0702421001	5841778	Suihkutangon pidike • Hållare till rail, sats (2 delar) • Rail holder, set	6,15	5,00	 7139411844509051
	Z5148001	5841730	Pyörä ø 21 (4 kpl) • Hjul ø 21 mm (4 st) • Wheel ø 21 mm (4 pcs)	13,00	10,50	 6441612913635461

IDO SHOWERAMA - Suihkunurkka 8-4, Duschhörna 8-4, Corner shower model 8-4 (2012-)

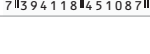

	Tuote Produkt Product	LVI- numero VVS- nummer	Nimike Benämning Item	Suositus- hinta Riktpris Price 24 % euro	Suositus- hinta Riktpris Price 0 % euro	EAN
①	Z073003000I	5872309	Asennussarja, 2 ovea • Monteringsatts, 2 dörr • Assembly kit, 2 door	43,00	34,65	
②			Lisätietoa ja hinta asiakaspalvelusta. • Information och pris vid förfrågan. Please ask for more information and price.			
③	Z354000I	5872306	Seinäprofiili • Vägprofil för slagdörr • Wall profile	37,80	30,45	
④	Z354100I	5861480	Väliprofiili • Mellanprofil • Middle profile	20,80	16,80	
⑤	Z20001400I	5854482	Ohjuripakkaus • Styrning för en slagdörr • Steering kit	15,60	12,60	
⑥	Z070483300I	5872310	Magneettiivisarja • Magnetlist komplett set • Magnetic sealing kit	36,50	29,40	
⑦	Z072903000I	5872315	Lattiatiiviste, 464 mm • Golvtätning, 464 mm • Floor sealing, 464 mm (700 mm)	11,70	9,45	
	Z072903100I	5872316	Lattiatiiviste, 564 mm • Golvtätning, 564 mm • Floor sealing, 564 mm (800 mm)	13,00	10,50	
	Z072903200I	5872317	Lattiatiiviste, 664 mm • Golvtätning, 664 mm • Floor sealing, 664 mm (900 mm)	13,00	10,50	
⑧	Z070080500I	5841779	Kahvan pidike • Handtagsfäste • Handle holder	21,22	17,25	
						

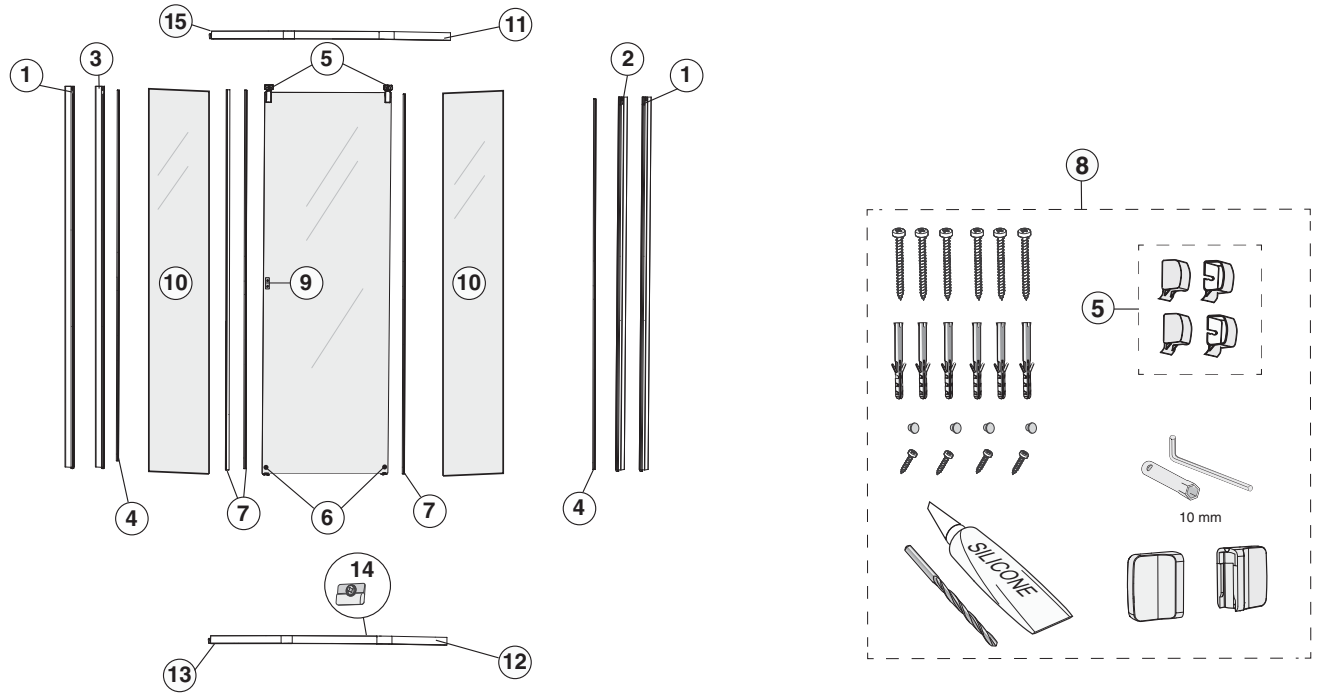
IDO SHOWERAMA - Suihkunurkka 8-3, Duschhörna 8-3, Corner shower model 8-3 (2013-)

	Tuote Produkt Product	LVI- numero VVS- nummer	Nimike Benämning Item	Suositus- hinta Riktpris Price 24 % euro	Suositus- hinta Riktpris Price 0 % euro	EAN
①	Z0737001001	5854522	Seinäprofiili • Vägprofil • Wall profile	81,85	66,00	
②	Z0738001001	5864001	Lasiprofiili • Glasprofil • Glass profile	45,90	37,00	
③						
④	Z0702721001	5841695	Lasitiiviste • U-profil • U-profile	5,20	4,20	
⑤	Z0705161001	5841634	Pyöräsarjapakkaus • Hjulupphängning komplett set • Wheel kit	46,90	37,80	
⑥	Z0705861001	5841633	Ohjuri • Dörrstyrning komplett set • Steering set	32,60	26,25	
⑦	Z0704861001	5841629	Ovitiivistesarja • Dörrtätninglist komplett set • Door sealing kit	43,00	34,65	
⑧	Z0771530001	5854523	Asennussarja • Monteringssats • Assembly kit	26,05	21,00	
⑨	Z0700805001	5841779	Kahvan pidike • Handtagsfäste • Handle holder	28,50	23,00	
⑩			Lisätietoa ja hinta asiakaspalvelusta. • Information och pris vid förfrågan. Please ask for more information and price.			
⑪	Z200028001	5854524	Yläprofiili 700x900 mm • Överliggare 700x900 mm Rear top backprofile cpl 700x900 mm	112,85	91,00	
	Z200029001	5854525	Yläprofiili 900x700 mm • Överliggare 900x700 mm Rear top backprofile cpl 900x700 mm	112,85	91,00	
	Z0700601001		Yläprofiili 800x900 mm, täyd/hopea • Överliggare frp 800x900 mm, silver Front top profile cpl 800x900 mm			
	Z0700602001		Yläprofiili 900x800 mm, täyd/hopea • Överliggare frp 900x800 mm, silver Front top profile cpl 900x800 mm			
	Z0700603001		Yläprofiili 900x900 mm, täyd/hopea • Överliggare frp 900x900 mm, silver Front top profile cpl 900x900 mm			
	Z0700604001		Yläprofiili 1000x1000 mm, täyd/hopea • Överliggare frp 1000x1000 mm, silver Front top profile cpl 1000x1000 mm			
⑫	Z0760401001	5854526	Sokkeliprofiili 700x900 mm • Sockelprofil 700x900 mm Socket profile 700x900 mm	135,15	109,00	
	Z0760501001	5854527	Sokkeliprofiili 900x700 mm • Sockelprofil 900x700 mm Socket profile 900x700 mm	135,15	109,00	

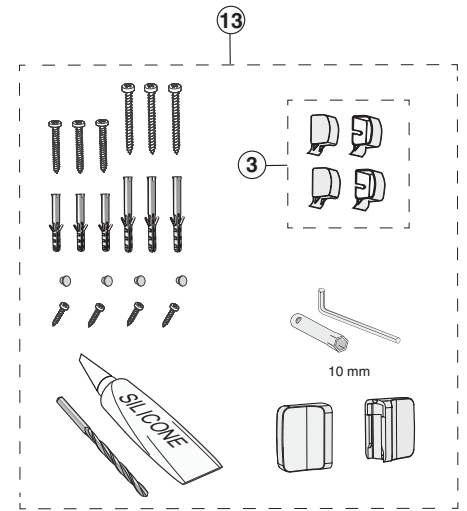
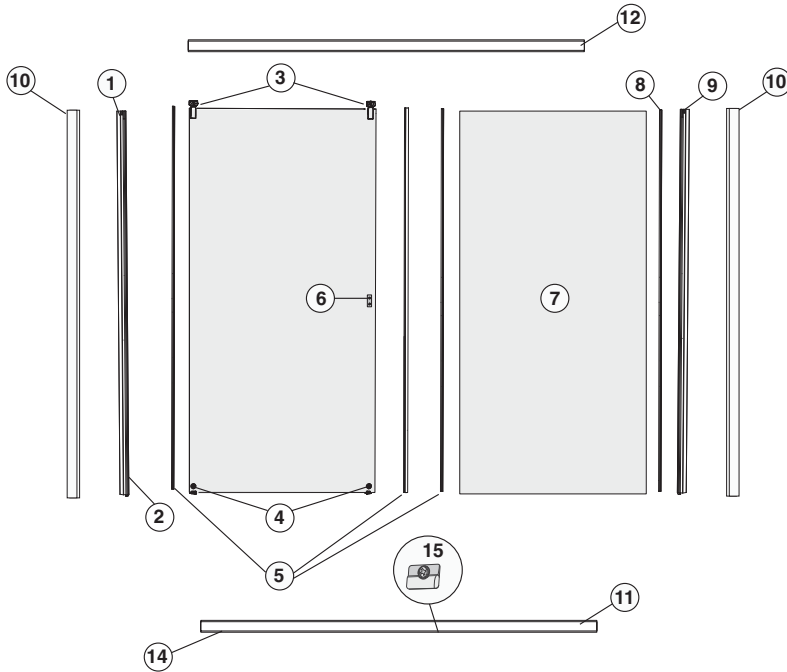
IDO SHOWERAMA - Liukuovi 8-I, Nischdusch 8-I, Sliding door 8-I (2013-)

	Tuote Produkt Product	LVI- numero VVS- nummer	Nimike Benämning Item	Suositus- hinta Riktpris Price 24 % euro	Suositus- hinta Riktpris Price 0 % euro	EAN
①	Z0739001001	5864000	Vastaprofiili • Anslagsprofil • Counter profile, complete	89,30	72,00	
②	Z0612221	5841766	Magneettilista • Magnetlister • Magnetic strip	43,40	35,00	
③	Z0705161001	5841634	Pyöräsarjapakkaus • Hjulupphängning komplett set • Wheel kit	46,90	37,80	
④	Z0705861001	5841633	Ohjuri • Dörrstyrning komplett set • Steering set	32,60	26,25	
⑤	Z0704861001	5841629	Ovitiiviste • Dörrtätninglist • Door sealing	43,00	34,65	
⑥	Z0700805	5841779	Kahvan pidike • Handtagsfäste • Handle holder	28,50	23,00	
⑦			Lisätietoa ja hinta asiakaspalvelusta. • Information och pris vid förfrågan. Please ask for more information and price.			
⑧	Z0702721001	5841695	Lasitiiviste • U-profil • U-profile	5,20	4,20	
⑨	Z0738001001	5864001	Lasinprofiili • Glasprofil • Glass profile	45,90	37,00	
⑩	Z0737001001	5854522	Seinäprofiili • Vägprofil • Wall profile	81,85	66,00	
⑪	Z07401131001		Lattiaprofiili, 1250 mm • Golvprofil, 1250 mm • Floor profile, 1250 mm	91,14	73,50	
	Z0740331001	5864003	Lattiaprofiili, 1350 mm • Golvprofil, 1350 mm • Floor profile, 1350 mm	122,75	99,00	
	Z0740531001	5864004	Lattiaprofiili, 1450 mm • Golvprofil, 1450 mm • Floor profile, 1450 mm	126,50	102,00	
	Z0740731001	5864005	Lattiaprofiili, 1550 mm • Golvprofil, 1550 mm • Floor profile, 1550 mm	128,95	104,00	
	Z0740931001	5864006	Lattiaprofiili, 1650 mm • Golvprofil, 1650 mm • Floor profile, 1650 mm	130,20	105,00	
	Z0741131001	5864007	Lattiaprofiili, 1750 mm • Golvprofil, 1750 mm • Floor profile, 1750 mm	135,15	109,00	
⑫	Z0750131001	5864008	Yläprofiili, 1250 mm • Topprofil, 1250 mm Top profile cpl, 1250 mm	110,35	89,00	

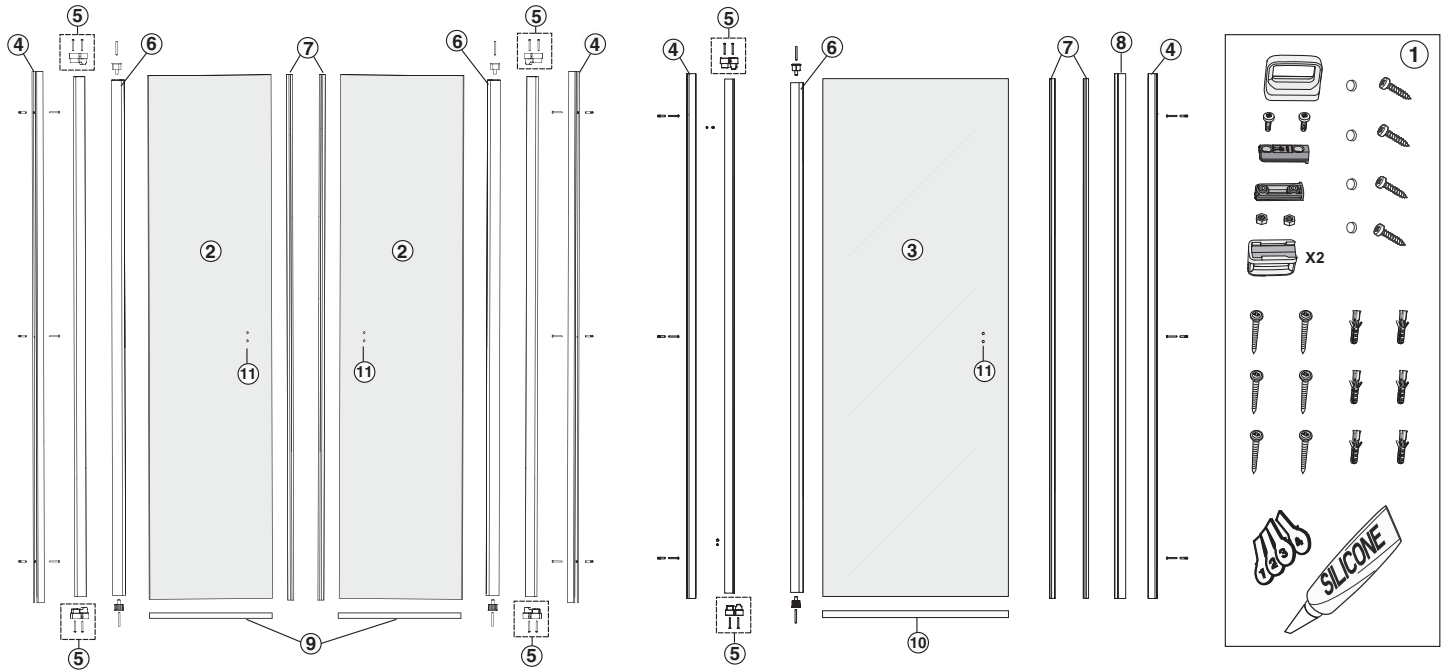
IDO SHOWERAMA - Suihkuseinä 8-0, Nischdusch 8-0, Swing door 8-0 (2012-)

	Tuote Produkt Product	LVI- numero VVS- nummer	Nimike Benämning Item	Suositus- hinta Riktpris Price 24 % euro	Suositus- hinta Riktpris Price 0 % euro	EAN
①	Z0730031001	5872318	Asennussarja, 1 ovi • Monteringsatts, 1 dörr • Assembly kit, 1 door	43,00	34,65	
	Z0730030001	5872309	Asennussarja, 2 ovea • Monteringsatts, 2 dörr • Assembly kit, 2 door	43,00	34,65	
②			Lisätietoa ja hinta asiakaspalvelusta. • Information och pris vid förfrågan.			
③			Please ask for more information and price.			
④	Z3540001	5872306	Seinäprofiili • Vägprofil • Wall profile	37,80	30,45	
⑤	Z200014001	5854482	Ohjuripakkaus • Styrning för en slagdörr • Steering kit	15,60	12,60	
⑥	Z3541001	5861480	Väliprofiili • Mellanprofil • Middle profile	20,85	16,80	
⑦	Z0704833001	5872310	Magneettitiivisarja • Magnetlist komplett set • Magnetic sealing kit	36,50	29,40	
⑧	Z3983001	5872313	Vastaprofiili • Anslagsprofil • Counter profile	44,30	35,70	
⑨	Z5370001	5872311	Lattiatiiviste, 549 mm • Golvtätningslist, 549 mm • Floor sealing, 549 mm	13,00	10,50	
⑩	Z5371001	5872312	Lattiatiiviste, 649 mm • Golvtätningslist, 649 mm Floor sealing, 649 mm (700 - 900 mm)	14,30	11,55	
⑪	Z0700805001	5841779	Kahvan pidike • Handtagsfäste • Handle holder	28,50	23,00	

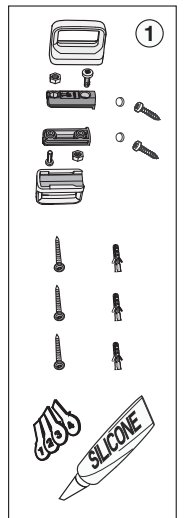
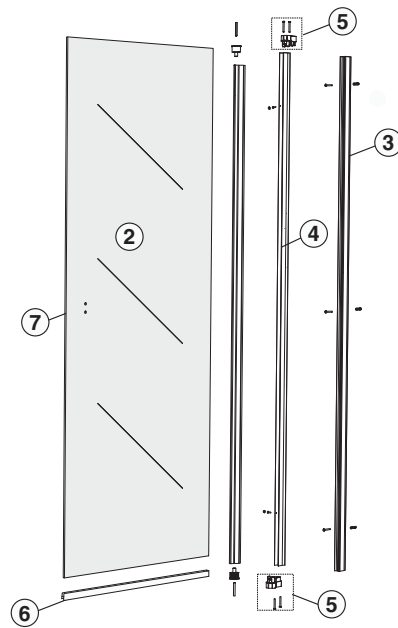
IDO SHOWERAMA - Suihkuseinä 8-01, Skärmvägg 8-01, Sliding door 8-01 (2012-)





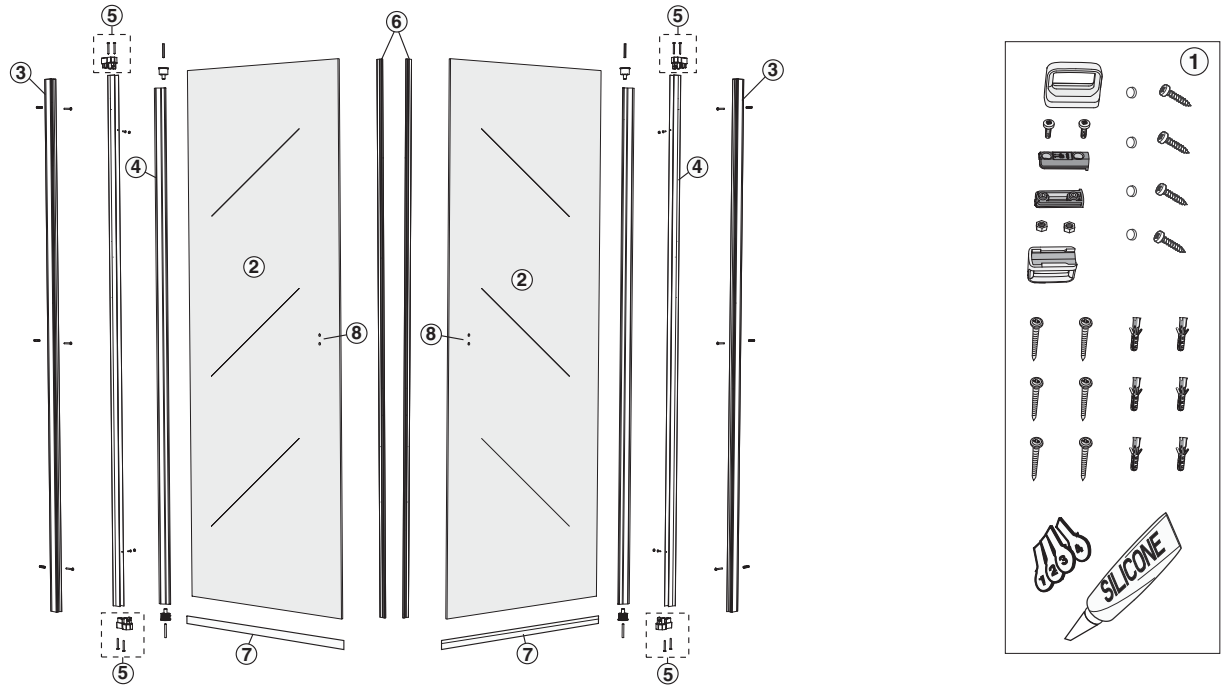

	Tuote Produkt Product	LVI- numero VVS- nummer	Nimike Benämning Item	Suositus- hinta Riktpris Price 24 % euro	Suositus- hinta Riktpris Price 0 % euro	EAN
①	Z0730031001	5872318	Asennussarja • Monteringssats • Assembly kit	43,00	34,65	71394118445666
②			Lisätieto ja hinta asiakaspalvelusta. • Information och pris vid förfrågan. Please ask for more information and price.			
③	Z3540001	5872306	Seinäprofiili • Vägprofil för slagdörr • Wall profile	37,80	30,45	71394118445543
④	Z3541001	5861480	Väliprofiili • Mellanprofil • Middle profile	20,80	16,80	644161291365441
⑤	Z200014001	5854482	Ohjuripakkaus • Styrning för en slagdörr • Steering kit	15,60	12,60	71394118447592
⑥	Z5371001	5872312	Lattiiviste, 649 mm • Golvtättningslist, 649 mm • Floor sealing, 649 mm	14,30	11,55	71394118445604
	Z5377001	5872308	Lattiiviste, 2 x 1000 mm • Golvtättningslist, 2 x 1000 mm Floor sealing, 2 x 1000 mm	24,70	19,95	71394118445567
⑦	Z0700805001	5841779	Kahvan pidike • Handtagsfäste • Handle holder	28,50	23,00	713941184451087

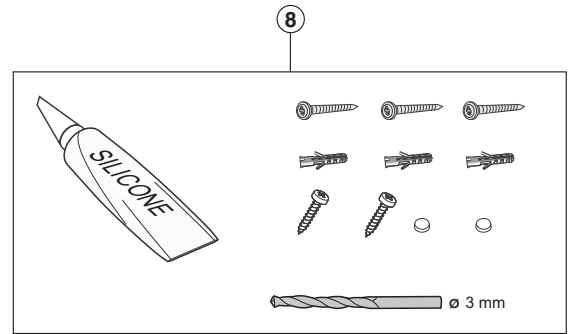
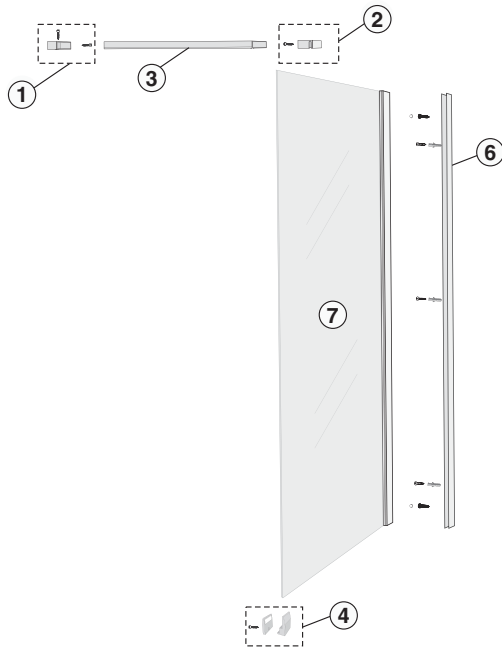
IDO SHOWERAMA - Suihkunurkka 8-02, Duschhörna 8-02, Corner shower model 8-02 (2012-)



	Tuote Produkt Product	LVI- numero VVS- nummer	Nimike Benämning Item	Suositus- hinta Riktpris Price 24 % euro	Suositus- hinta Riktpris Price 0 % euro	EAN
①	Z0730030001	5872309	Asennussarja, 2 ovea • Monteringsatts, 2 dörr • Assembly kit, 2 door	43,00	34,65	
②			Lisätietoa ja hinta asiakaspalvelusta. • Information och pris vid förfrågan. Please ask for more information and price.			
③	Z3540001	5872306	Seinäprofiili • Vägprofil för slagdörr • Wall profile	37,80	30,45	
④	Z3541001	5861480	Väliprofiili • Mellanprofil • Middle profile	20,80	16,80	
⑤	Z200014001	5854482	Ohjuripakkaus • Styrning för en slagdörr • Steering kit	15,60	12,60	
⑥	Z0704862001	5872307	Magneettiiv.sarja • Magnetlist komplett set • Magnetic sealing kit	36,50	29,40	
⑦	Z5377001	5872308	Lattiatiiviste, 2 x 1000 mm • Golvtättningslist, 2 x 1000 mm Floor sealing, 2 x 1000 mm	24,70	19,95	
⑧	Z0700805001	5841779	Kahvan pidike • Handtagsfäste • Handle holder	28,50	23,00	

IDO SHOWERAMA - Suihkuseinä 8-20, Skärmvägg fast 8-20, Fixed enclosure 8-20 (2013-)

	Tuote Produkt Product	LVI- numero VVS- nummer	Nimike Benämning Item	Suositus- hinta Riktpris Price 24 % euro	Suositus- hinta Riktpris Price 0 % euro	EAN
①	Z73032000I	5861476	Seinäkiinnike • Väggfäste • Wall fixing	22,10	17,85	
②	Z73052000I	5861478	Lasinkiinnike • Glasfäste • Glass fixing	22,10	17,85	
③	Z73042000I	5861477	Tanko, seinäkiinnike • Stag • Rail, wall fixing	22,10	17,85	
④	0730780	5861475	Lattiatuki • Golvfäste • Floor support	55,70	44,80	
⑥	Z073700300I	5864017	Seinäprofili, 1950 mm • Vägprofil, 1950 mm • Wall profile, 1950 mm	80,60	65,00	
	Z073700500I	5864018	Seinäprofili, 2250 mm • Vägprofil, 2250 mm • Wall profile, 2250 mm	84,30	68,00	
⑦			Lisätietoa ja hinta asiakaspalvelusta. • Information och pris vid förfrågan. Please ask for more information and price.			
⑧	Z073163000I	5864019	Asennussarja • Monteringssats • Assembly kit	70,70	57,00	

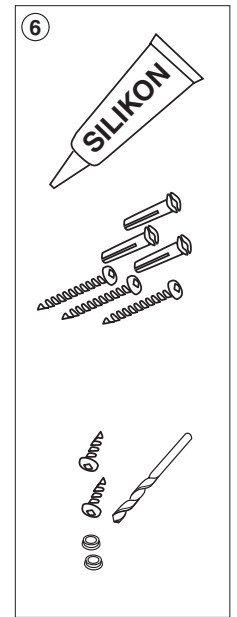
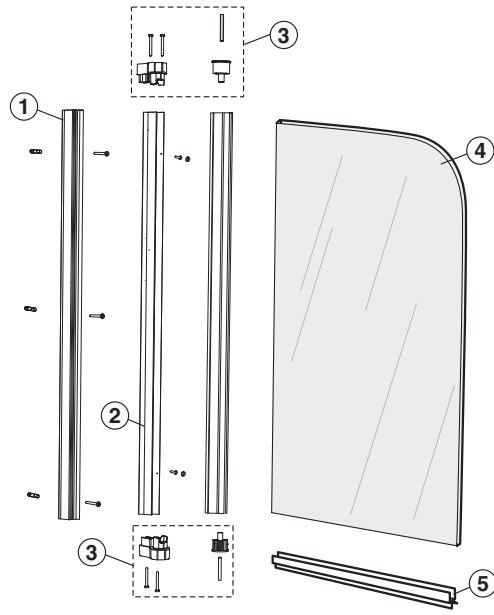
IDO SHOWERAMA - Suihkuseinä 8-40, Badkarskärm 8-40, Swing door 8-40 (2012-)

	Tuote Produkt Product	LVI- numero VVS- nummer	Nimike Benämning Item	Suositus- hinta Riktpris Price 24 % euro	Suositus- hinta Riktpris Price 0 % euro	EAN
①	Z3540001	5872306	Seinäprofiili • Vägprofil för slagdörr • Wall profile	37,80	30,45	713941184455431
②	Z3541001	5861480	Väliprofiili • Mellanprofil • Middle profile	20,80	16,80	6441612943654411
③	Z200014001	5854482	Ohjuripakkaus • Styrning för en slagdörr • Steering kit	15,60	12,60	7139411844475921
④			Lisätietoa ja hinta asiakaspalvelusta. • Information och pris vid förfrågan. Please ask for more information and price.			
⑤	Z5370001	5872311	Lattiatiiviste, 549 mm • Golvtättningslist, 549 mm • Floor sealing, 549 mm	13,00	10,50	713941184455981
⑥	Z5784001	5872319	Asennussarja • Monteringsatts • Assembly kit	15,60	12,60	713941184456731

IDO SHOWERAMA - Suihkuseinä 8-4I, Skärmvägg 8-4I, Swing door 8-4I (2012-)

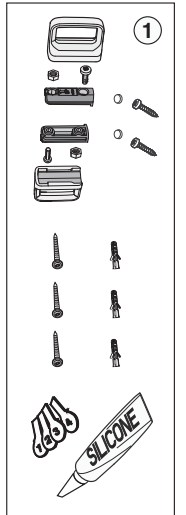
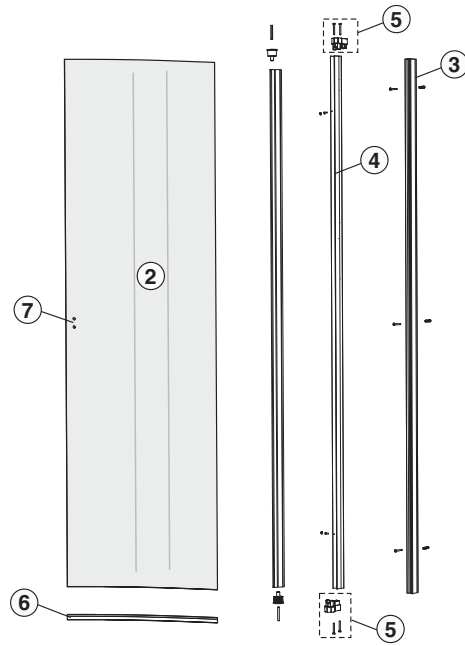



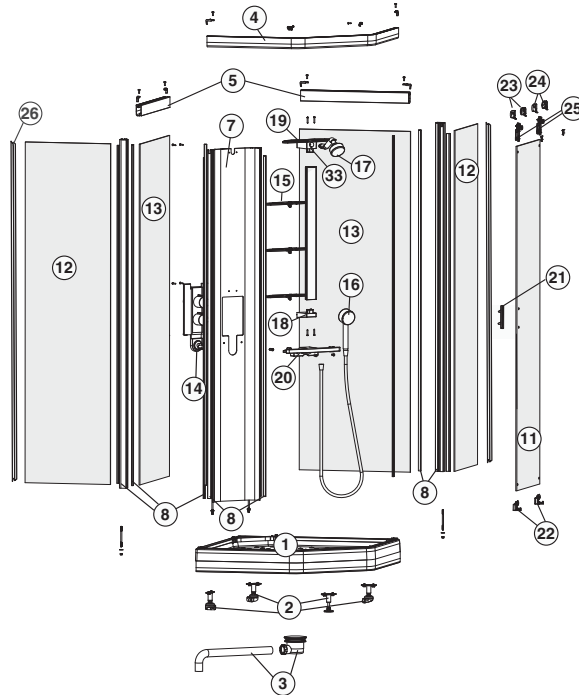



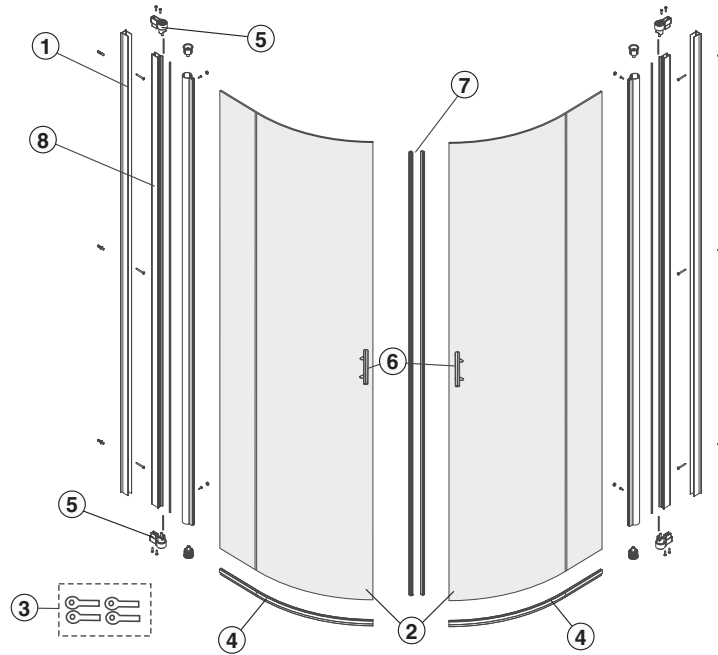



	Tuote Produkt Product	LVI- numero VVS- nummer	Nimike Benämning Item	Suositus- hinta Riktpris Price 24 % euro	Suositus- hinta Riktpris Price 0 % euro	EAN
①	Z0730031001	5872318	Asennussarja • Monteringssats • Assembly kit (sis./inkl./ incl. Z0700802001)	43,00	34,65	 7 1394118 445666
②			Lisätietoa ja hinta asiakaspalvelusta. • Information och pris vid förfrågan. Please ask for more information and price.			
③	Z3540001	5872306	Seinäprofiili • Vägprofil för slagdörr • Wall profile	37,80	30,45	 7 1394118 445543
④	Z3541001	5861480	Väliprofiili • Mellanprofil • Middle profile	20,80	16,80	 6 4416129 1365441
⑤	Z200014001	5854482	Ohjuripakkaus • Styrning för en slagdörr • Steering kit	15,60	12,60	 7 1394118 447592
⑥	Z0729030001	5872315	Lattiatiiviste, 464 mm • Golvtätning, 464 mm • Floor sealing, 464 mm	11,70	9,45	 7 1394118 445635
	Z0729031001	5872316	Lattiatiiviste, 564 mm • Golvtätning, 564 mm • Floor sealing, 564 mm	13,00	10,50	 7 1394118 445642
	Z0729032001	5872317	Lattiatiiviste, 664 mm • Golvtätning, 664 mm • Floor sealing, 664 mm	13,00	10,50	 7 1394118 445659
⑦	Z0700805001	5841779	Kahvan pidike • Handtagsfäste • Handle holder	28,50	23,00	 7 1394118 4451087

IDO SHOWERAMA - Suihkukaappi, Duschkabin, Shower cabin 7-5 (2005-2011)

	Tuote Produkt Product	LVI- numero VVS- nummer	Nimike Benämning Item	Suositus- hinta Riktpris Price 24 % euro	Suositus- hinta Riktpris Price 0 % euro	EAN
①			Lisätietoa ja hinta asiakaspalvelusta. • Information och pris vid förfrågan. Please ask for more information and price.			
②	Z7110001	5841688	Altaan pyöräsarja • Hjul för kabinkar komplett Wheel set for shower tray	43,00	34,65	
③	Z7292001	5854483	Vesilukko+poistoputki ø 40 • Avloppssats, komplett ø 40 Outlet set, complete ø 40	35,20	28,35	
⑧	Z5381001	5854475	Lasilista • Tätninglist glas/väggprofil • Glass sealing	22,10	17,85	
⑭	Z7240001	5811800	Sekoittaja, täydellinen • Blandare, komplett • Mixer ORAS, complete	293,00	236,25	
⑮	Z200021001	5841595	Suihkuhylly, täydellinen • Dushyllor, komplett • Shower shelf kit, complete	43,00	34,65	
⑰	Z200016001	5841603	Suihkusetti, täydellinen • Duschset, komplett • Shower set, complete	58,60	47,25	
⑰	Z200017001	5841604	Yläsuihkun kiinnike / hylly • Övre fäste för duschrör / hylla Upper fastener for shelf pillar	33,90	27,30	
⑳	Z5724001	5841736	Hyly/vedin • Hylla/handtag • Shelf/handle	43,00	34,65	
㉑	Z7180001	5861392	Vedin, täydellinen • Dörrhandtag, komplett • Door handle, complete	27,30	22,05	
㉒	Z200013001	5854438	Ohjuripakkaus, täydellinen • Dörrstyrning, komplett • Steering kit, complete	28,60	23,10	
㉓	Z200015001	5841600	Pyöräsarja, täydellinen, pyörät • Hjulupphängningssats, komplett, hjul Door hanging advice complete, wheels	41,70	33,60	
㉔						
㉕						
㉖	Z5383001	5854419	Ovitiiviste • Dörrtätninglist • Door sealing	28,60	23,10	
⑳	Z200018001	5841626	Lasin asennussarja, täydellinen • Glasanhållssats, komplett Glass mounting kit, complete	15,60	12,60	
	Z5775001	5841625	Asennussarja, täydellinen • Monteringssats, komplett Mounting kit, complete	74,20	59,85	
	Z5766001	5861481	Oven pysäytin • Dörrstopp • Door stopper	9,90	8,00	





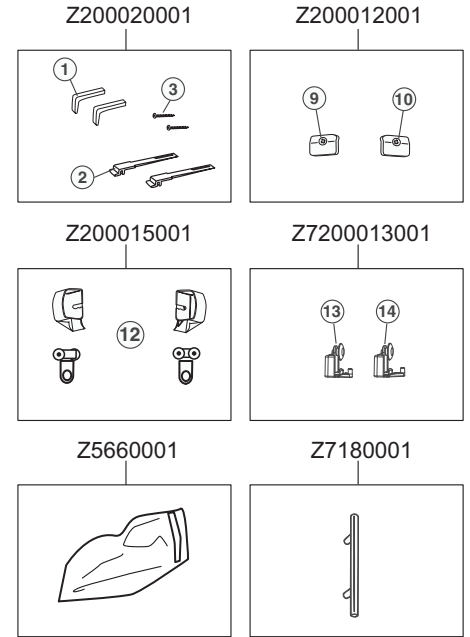
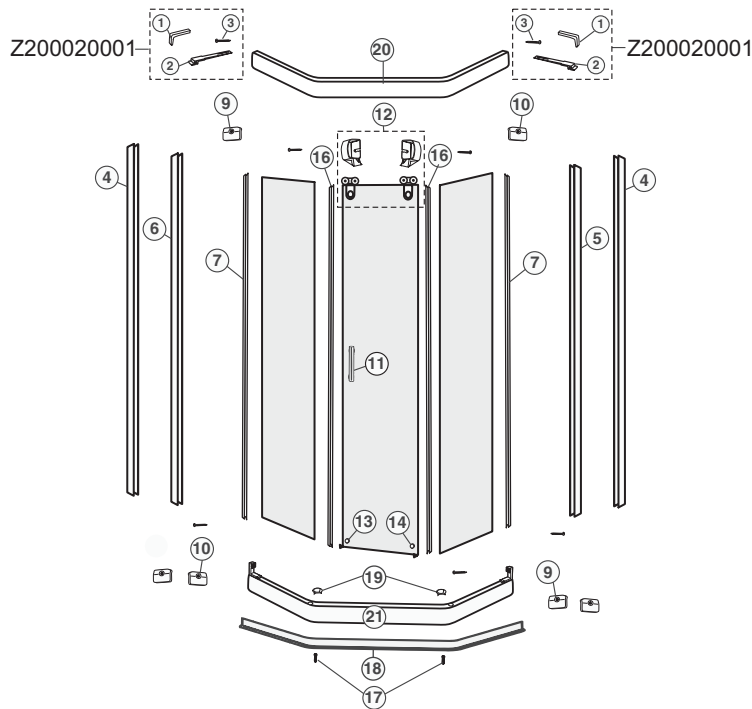



IDO SHOWERAMA - Suihkunurkka 7-4, Duschhörna 7-4, Corner shower model 7-4 (2005-2011)

	Tuote Produkt Product	LVI- numero VVS- nummer	Nimike Benämning Item	Suositus- hinta Riktpris Price 24 % euro	Suositus- hinta Riktpris Price 0 % euro	EAN
1	Z3540001	5872306	Seinäprofiili • Vägprofil för slagdörr • Wall profile	37,80	30,45	 7 1394118445543
2			Lisätietoja ja hinta asiakaspalvelusta. • Information och pris vid förfrågan. Please ask for more information and price.			
3	Z5695001	5854480	Välipalat • Distanser • Interlaid pieces	10,40	8,40	 7 1394118447561
4	Z5370001	5872311	Lattiatiiviste, 549 mm • Golvtättningslist, 549 mm • Floor sealing, 549 mm	13,00	10,50	 7 1394118445598
	Z5371001	5872312	Lattiatiiviste, 649 mm • Golvtättningslist, 649 mm • Floor sealing, 649 mm	14,30	11,55	 7 1394118445604
	Z5377001	5872308	Lattiatiiviste, 2 x 1000 mm • Golvtättningslist, 2 x 1000 mm Floor sealing, 2 x 1000 mm	24,70	19,95	 7 1394118445567
	Z5394001	5854478	Lattiatiiviste, 2100 mm (korkea) • Golvtättningslist, 2100 mm (hög) Floor sealing, 2100 mm (high)	27,30	22,05	 7 1394118447547
5	Z200014001	5854482	Ohjuripakkaus • Styrning för en slagdörr • Steering kit	15,60	12,60	 7 1394118447592
6	Z7180001	5861392	Vedin, täydellinen • Duschhandtag, komplett Door handle, complete	27,30	22,05	 7 1394118449329
7	Z5373001	5854479	Magneettilista • Magnetlister • Magnetic seal	35,20	28,35	 7 1394118447554
8	Z3541001	5861480	Väliprofiili • Mellanprofil • Middle profile	20,80	16,80	 6 1416129365441

IDO SHOWERAMA - Symmetrinen 7-3, Symmetrisk 7-3, Corner shower model 7-3 (2005-)

	Tuote Produkt Product	LVI- numero VVS- nummer	Nimike Benämning Item	Suositus- hinta Riktpris Price 24 % euro	Suositus- hinta Riktpris Price 0 % euro	EAN
①	Z200020001	5854468	Yläprofiilin kiinnityssarja • Fastsättning överliggare • Top profile fastening kit	13,00	10,50	
②						
③						
④	Z3740001	5854469	Seinäprofiili, hopea • Vägprofil, silver • Wall profile, silver	48,20	38,85	
⑤	Z3742001	5854471	Lasiprofiili, hopea (oikea) • Glasprofil, silver (höger) Glass profile, white (right)	49,50	39,90	
⑥	Z3743001	5854472	Lasiprofiili, hopea (vasen) • Glasprofil, silver (vänster) Glass profile, white (left)	49,50	39,90	
⑦	Z5381001	5854475	Lasilista • Tätninglist glas/vägprofil • Glass sealing	22,10	17,85	
⑨	Z200012001	5854435	Lasinpidike, täydellinen • Glasanhåll, komplett Glass stop, complete	7,80	6,30	
⑩						
⑪	Z7180001	5861392	Vedin, täydellinen • Dörrhandtag, komplett • Door handle, complete	27,30	22,05	
⑫	Z200015001	5841600	Pyöräsarja, täydellinen, pyörät • Hjulupphängningssats, komplett, hjul Door hanging advices complete, wheels	41,70	33,60	
⑬	Z200013001	5854438	Ohjuripakkaus, täydellinen • Dörrstyrning, komplett • Steering kit, complete	28,60	23,10	
⑭						
⑯	Z5383001	5854419	Ovitiiviste • Dörrtätninglist • Door sealing	28,60	23,10	
⑰	Z5393001	5854436	Lattiatiiviste • Golvtätninglist • Floor sealing	35,20	28,35	
⑱	Z5671001	5841735	Jalan peitetulppa • Täcklock fot • Cover plug for socket	3,90	3,15	
⑳	Z3702001	5854448	Yläprofiili 700x900 mm, hopea • Överliggare 700x900 mm, silver Top profile 700x900 mm, silver	71,60	57,75	
	Z3704001	5854450	Yläprofiili 900x700 mm, hopea • Överliggare 900x700 mm, silver Top profile 900x700 mm, silver	71,60	57,75	
	Z3706001	5854452	Yläprofiili 800x900 mm, hopea • Överliggare 800x900 mm, silver Top profile 800x900 mm, silver	71,60	57,75	
	Z3708001	5854454	Yläprofiili 900x800 mm, hopea • Överliggare 900x800 mm, silver Top profile 900x800 mm, silver	71,60	57,75	

IDO SHOWERAMA - Symmetrinen 7-3, Symmetrisk 7-3, Corner shower model 7-3 (2005-)

	Tuote Produkt Product	LVI- numero VVS- nummer	Nimike Benämning Item	Suositus- hinta Riktpris Price 24 % euro	Suositus- hinta Riktpris Price 0 % euro	EAN
20	Z3710001	5854456	Yläprofiili 900x900 mm, hopea • Överliggare 900x900 mm, silver Top profile 900x900 mm, silver	88,50	71,40	 7 1394118 447271
21	Z3701001	5854458	Alaprofiili 700x900 mm, hopea • Sockelprofil 700x900 mm, silver Socket profile 700x900 mm, silver	76,80	61,95	 7 1394118 447318
	Z3703001	5854460	Alaprofiili 900x700 mm, hopea • Sockelprofil 900x700 mm, silver Socket profile 900x700 mm, silver	76,80	61,95	 7 1394118 447332
	Z3705001	5854462	Alaprofiili 800x900 mm, hopea • Sockelprofil 800x900 mm, silver Socket profile 800x900 mm, silver	93,75	75,60	 7 1394118 447356
	Z3707001	5854464	Alaprofiili 900x800 mm, hopea • Sockelprofil 900x800 mm, silver Socket profile 900x800 mm, silver	93,75	75,60	 7 1394118 447370
	Z3709001	5854466	Alaprofiili 900x900 mm, hopea • Sockelprofil 900x900 mm, silver Socket profile 900x900 mm, silver	93,75	75,60	 7 1394118 447394
	Z5660001	5854437	Aseennussarja • Monteringssats • Assembly kit	52,10	42,00	 7 1394118 447103
	Z5148001	5841730	Pyörä ø 21 (4 kpl) • Hjul ø 21 mm (4 st) • Wheel ø 21 mm (4 pcs)	13,00	10,50	 6 416129 363546

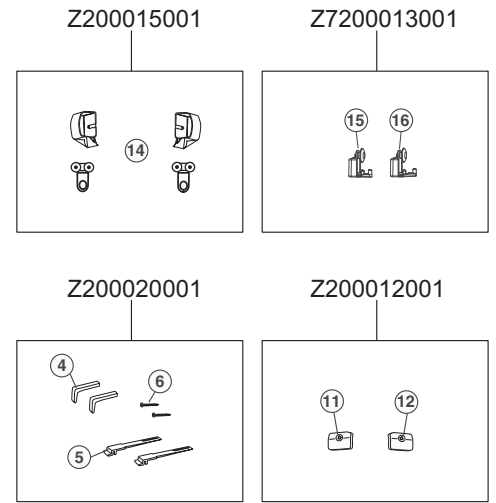
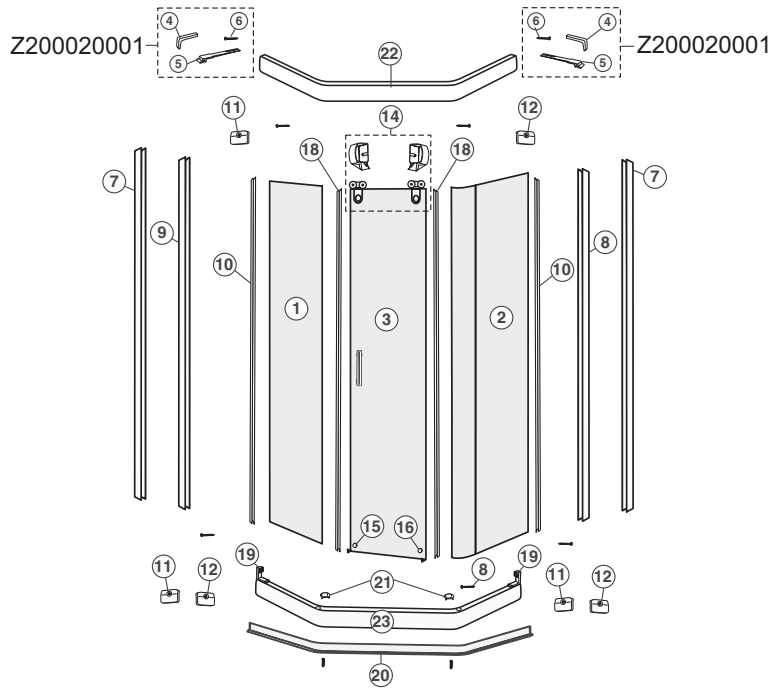
IDO SHOWERAMA - Epäsymmetrinen 7-2, Asymmetrisk 7-2, Asymmetric corner shower model 7-2 (2004-2011)

	Tuote Produkt Product	LVI- numero VVS- nummer	Nimike Benämning Item	Suositus- hinta Riktpris Price 24 % euro	Suositus- hinta Riktpris Price 0 % euro	EAN
①			Lisätietoa ja hinta asiakaspalvelusta. • Information och pris vid förfrågan.			
②			Please ask for more information and price.			
③						
④	Z200020001	5854468	Ylärofiilin kiinnityssarja • Fastsättning överliggare • Upper profile fastening kit	13,00	10,50	
⑤						
⑥						
⑧	Z3642001	5854473	Lasiprofiili, valkoinen (oikea) • Glasprofil, vit (höger) Glass profile, white (right)	39,10	31,50	
	Z3742001	5854471	Lasiprofiili, hopea (oikea) • Glasprofil, silver (höger) Glass profile, white (right)	49,50	39,90	
⑨	Z3643001	5854474	Lasiprofiili, valkoinen (vasen) • Glasprofil, vit (vänster) Glass profile, white (left)	39,10	31,50	
	Z3743001	5854472	Lasiprofiili, hopea (vasen) • Glasprofil, silver (vänster) Glass profile, white (left)	49,50	39,90	
⑩	Z5381001	5854475	Lasilista • Tätninglist glas/väggprofil • Glass sealing	22,10	17,85	
⑪	Z200012001	5854435	Lasinpidike, täydellinen • Glasanhåll, komplett Glass stop, complete	7,80	6,30	
⑫						
⑬	Z7180001	5861392	Vedin, täydellinen • Dörrhandtag, komplett Door handle, complete	27,30	22,05	
⑭	Z200015001	5841600	Pyöräsarja, täydellinen, pyörät • Hjulupphängningssats, komplett, hjul Door hanging advices complete, wheels	41,70	33,60	
⑮	Z200013001	5854438	Ohjuriipakkaus, täydellinen • Dörrstyrning, komplett • Steering kit, complete	28,60	23,10	
⑯						
⑱	Z5383001	5854419	Ovitiiviste • Dörrtätninglist • Door sealing	28,60	23,10	
⑳	Z5392001	5854422	Lattiatiiviste, täydellinen • Golvtätninglist, komplett Floor sealing, complete	37,80	30,45	
㉑	Z5671001	5841735	Jalan peitetulppa • Täcklock fot • Cover plug for socket	3,90	3,15	
	Z5148001	5841730	Pyörä ø 21 (4 kpl) • Hjul ø 21 mm (4 st) • Wheel ø 21 mm (4 pcs)	13,00	10,50	

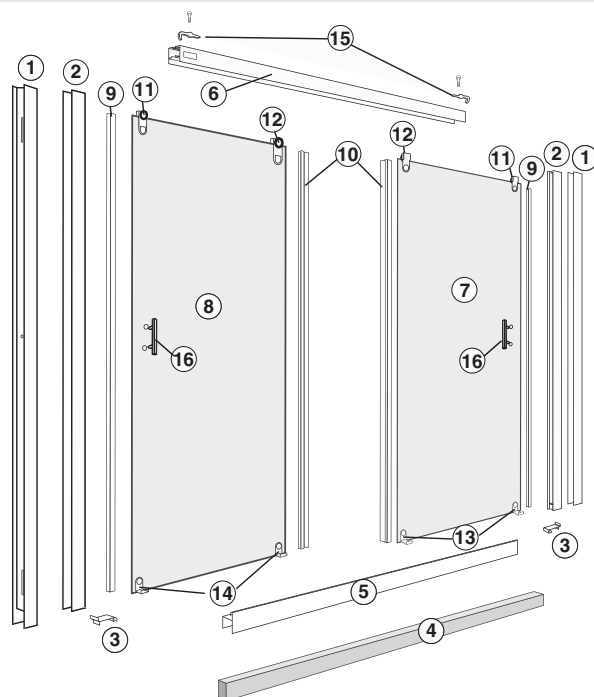
IDO SHOWERAMA - Liukuovi 7-I, Nischdusch 7-I, Sliding door 7-I (2005-2013)

	Tuote Produkt Product	LVI- numero VVS- nummer	Nimike Benämning Item	Suositus- hinta Riktpris Price 24 % euro	Suositus- hinta Riktpris Price 0 % euro	EAN
①	Z3940001	5854413	Seinäprofiili • Vägprofil • Wall profile	44,30	35,70	
②	Z3942001	5854414	Lasiprofiili • Glasprofil • Glass profile	46,90	37,80	
③	Z3765001	5854415	Sokkelikiinnike • Fäste för sockelprofil • Socket fastening	3,90	3,15	
④	Z5355001	5854412	Lattiatiiviste • Golvtättningslist • Floor sealing	33,90	27,30	
⑤	Z3925001	5854416	Sokkeliprofiili • Sockelprofil • Socket profile	26,00	21,00	
⑥	Z39239001	5841763	Yläprofiili • Överliggare • Top profile	30,27	24,41	
⑦			Lisätietoa ja hinta asiakaspalvelusta. • Information och pris vid förfrågan.			
⑧			Please ask for more information and price.			
⑨	Z5353001	5854420	Vastalista • Anslagslist • Shockproof sealing	29,90	24,15	
⑩	Z5383001	5854419	Ovitiiviste • Dörrtättningslist • Door sealing	28,60	23,10	
⑪	Z200010001	5854417	Pyöräsarja, täydellinen • Hjulupphängningssats • Wheel kit	32,60	26,25	
⑫						
⑬	Z200011001	5854418	Ohjustinpakkaus, täydellinen • Dörrstyrning komplett • Steering kit, complete	41,70	33,60	
⑭						
⑮	Z200020001	5854468	Yläprofiilin kiinnityssarja • Fastsättning överliggare • Top profile fastening kit	13,00	10,50	
⑯	Z7180001	5861392	Vedin, täydellinen • Dörrhandtag, komplett • Door handle, complete	27,30	22,05	
	Z5771001	5854421	Asennussarja • Monteringsats • Assembly kit	62,50	50,40	
	Z5148001	5841730	Pyörä ø 21 (4 kpl) • Hjul ø 21 mm (4 st) • Wheel ø 21 mm (4 pcs)	13,00	10,50	

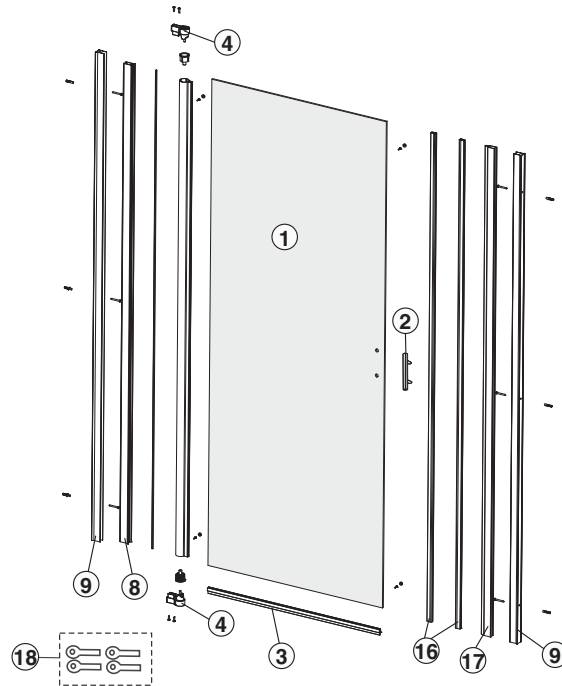
IDO SHOWERAMA - Kääntöovi 7-0, Nischdusch 7-0, Swing door 7-0 (2005-2011)

	Tuote Produkt Product	LVI- numero VVS- nummer	Nimike Benämning Item	Suositus- hinta Riktpris Price 24 % euro	Suositus- hinta Riktpris Price 0 % euro	EAN
①			Lisätietoa ja hinta asiakaspalvelusta. • Information och pris vid förfrågan. Please ask for more information and price.			
②	Z7180001	5861392	Vedin, täydellinen • Dörrhandtag, komplett Door handle, complete	27,30	22,05	
③	Z5370001	5872311	Lattiatiiviste, 549 mm • Golvtättningslist, 549 mm • Floor sealing, 549 mm	13,00	10,50	
	Z5371001	5872312	Lattiatiiviste, 649 mm • Golvtättningslist, 649 mm • Floor sealing, 649 mm	14,30	11,55	
	Z5377001	5872308	Lattiatiiviste, 2 x 1000 mm • Golvtättningslist, 2 x 1000 mm Floor sealing, 2 x 1000 mm	24,70	19,95	
	Z5394001	5854478	Lattiatiiviste, 2100 mm (korkea) • Golvtättningslist, 2100 mm (hög) Floor sealing, 2100 mm (high)	27,30	22,05	
④	Z200014001	5854482	Ohjuripakkaus • Styrning för en slagdörr • Steering kit	15,60	12,60	
⑤						
⑥						
⑧	Z3541001	5861480	Väliprofiili • Mellanprofil • Middle profile	20,80	16,80	
⑨	Z3540001	5872306	Seinäprofiili • Vägprofil för slagdörr • Wall profile	37,80	30,45	
⑬	Z5373001	5854479	Magneettilista • Magnetlister • Magnetic strips	35,20	28,35	
⑰	Z3983001	5872313	Vastaprofiili • Anslagsprofil • Counter profile	44,30	35,70	
⑱	Z5695001	5854480	Välipalat • Distanser • Interlaid pieces	10,40	8,40	

IDO SHOWERAMA - Suihkuseinä 7-01, Skärmvägg 7-01, Swing door 7-01 (2005-2011)

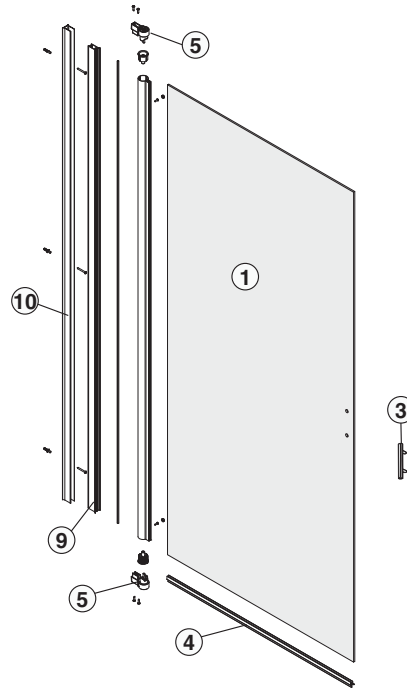

	Tuote Produkt Product	LVI- numero VVS- nummer	Nimike Benämning Item	Suositus- hinta Riktpris Price 24 % euro	Suositus- hinta Riktpris Price 0 % euro	EAN
①			Lisätietoa ja hinta asiakaspalvelusta. • Information och pris vid förfrågan. Please ask for more information and price.			
③	Z7180001	5861392	Vedin, täydellinen • Dörrhandtag, komplett • Door handle, complete	27,30	22,05	
④	Z5370001	5872311	Lattiatiiviste, 549 mm • Golvtättningslist, 549 mm • Floor sealing, 549 mm	13,00	10,50	
	Z5371001	5872312	Lattiatiiviste, 649 mm • Golvtättningslist, 649 mm • Floor sealing, 649 mm	14,30	11,55	
	Z5377001	5872308	Lattiatiiviste, 2 x 1000 mm • Golvtättningslist, 2 x 1000 mm Floor sealing, 2 x 1000 mm	24,70	19,95	
	Z5394001	5854478	Lattiatiiviste, 2100 mm (korkea) • Golvtättningslist, 2100 mm (hög) Floor sealing, 2100 mm (high)	27,30	22,05	
⑤	Z200014001	5854482	Ohjuripakkaus • Styrning för en slagdörr • Steering kit	15,60	12,60	
⑥						
⑦						
⑨	Z3541001	5861480	Väliprofiili • Mellanprofil • Middle profile	20,80	16,80	
⑩	Z3540001	5872306	Seinäprofiili • Vägprofil för slagdörr • Wall profile	37,80	30,45	

IDO SHOWERAMA - Suihkuseinä 7-02, Duschhörna 7-02, Shower corner 7-02 (2005-2011)

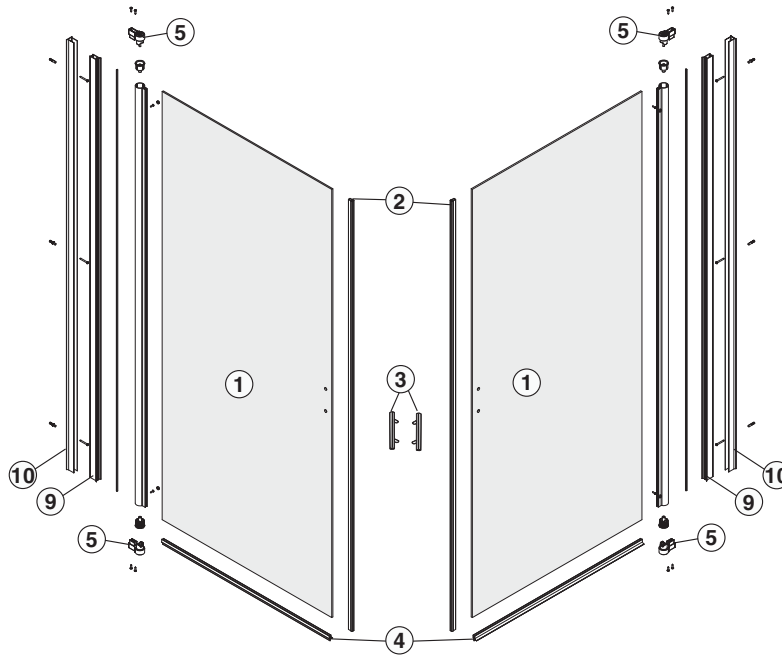

	Tuote Produkt Product	LVI- numero VVS- nummer	Nimike Benämning Item	Suositus- hinta Riktpris Price 24 % euro	Suositus- hinta Riktpris Price 0 % euro	EAN
①			Lisätietoa ja hinta asiakaspalvelusta. • Information och pris vid förfrågan. Please ask for more information and price.			
②	Z5317001	5854411	Magneettilista • Magnetlister • Magnetic seal	37,80	30,45	
③	Z7180001	5861392	Vedin, täydellinen • Dörrhandtag, komplett Door handle, complete	27,30	22,05	
④	Z5370001	5872311	Lattiatiiviste, 549 mm • Golvtättningslist, 549 mm • Floor sealing, 549 mm	12,40	10,00	
	Z5371001	5872312	Lattiatiiviste, 649 mm • Golvtättningslist, 649 mm • Floor sealing, 649 mm	13,64	11,00	
	Z5377001	5872308	Lattiatiiviste, 2 x 1000 mm • Golvtättningslist, 2 x 1000 mm Floor sealing, 2 x 1000 mm	24,70	19,95	
	Z5394001	5854478	Lattiatiiviste, 2100 mm (korkea) • Golvtättningslist, 2100 mm (hög) Floor sealing, 2100 mm (high)	27,30	22,05	
⑤	Z200014001	5854482	Ohjuripakkaus • Styrning för en slagdörr • Steering kit	15,60	12,60	
⑥						
⑦						
⑨	Z3541001	5861480	Väliprofiili • Mellanprofil • Middle profile	20,80	16,80	
⑩	Z3540001	5872306	Seinäprofiili • Vägghögl för slagdörr • Wall profile	37,80	30,45	

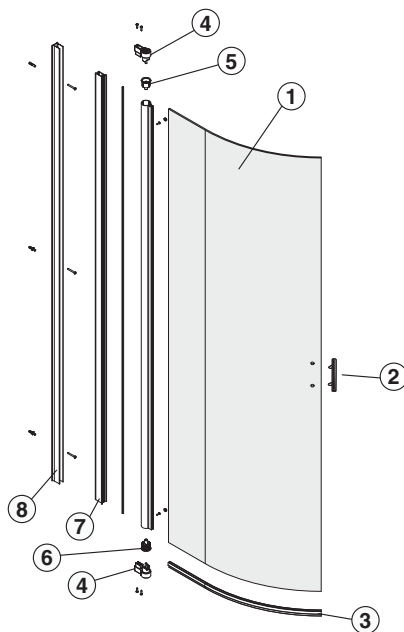
IDO SHOWERAMA - Suihkuovi 7-41/7-42, Skärmvägg 7-41/7-42, Swing door 7-41/7-42 (2005-2011)

	Tuote Produkt Product	LVI- numero VVS- nummer	Nimike Benämning Item	Suositus- hinta Riktpris Price 24 % euro	Suositus- hinta Riktpris Price 0 % euro	EAN
①			Lisätietoa ja hinta asiakaspalvelusta. • Information och pris vid förfrågan. Please ask for more information and price.			
②	Z7180001	5861392	Vedin, täydellinen • Dörrhandtag, komplett Door handle, complete	27,30	22,05	
③	Z5370001	5872311	Lattiatiiviste, 549 mm • Golvtättningslist, 549 mm • Floor sealing, 549 mm	13,00	10,50	
	Z5371001	5872312	Lattiatiiviste, 649 mm • Golvtättningslist, 649 mm • Floor sealing, 649 mm	14,30	11,55	
	Z5377001	5872308	Lattiatiiviste, 2 x 1000 mm • Golvtättningslist, 2 x 1000 mm Floor sealing, 2 x 1000 mm	24,70	19,95	
	Z5394001	5854478	Lattiatiiviste, 2100 mm (korkea) • Golvtättningslist, 2100 mm (hög) Floor sealing, 2100 mm (high)	27,30	22,05	
④	Z200014001	5854482	Ohjuripakkaus • Styrning för en slagdörr • Steering kit	15,60	12,60	
⑤						
⑥						
⑦	Z3541001	5861480	Väliprofili • Mellanprofil • Middle profile	20,80	16,80	
⑧	Z3540001	5872306	Seinäprofili • Vägoprofil för slagdörr • Wall profile	37,80	30,45	

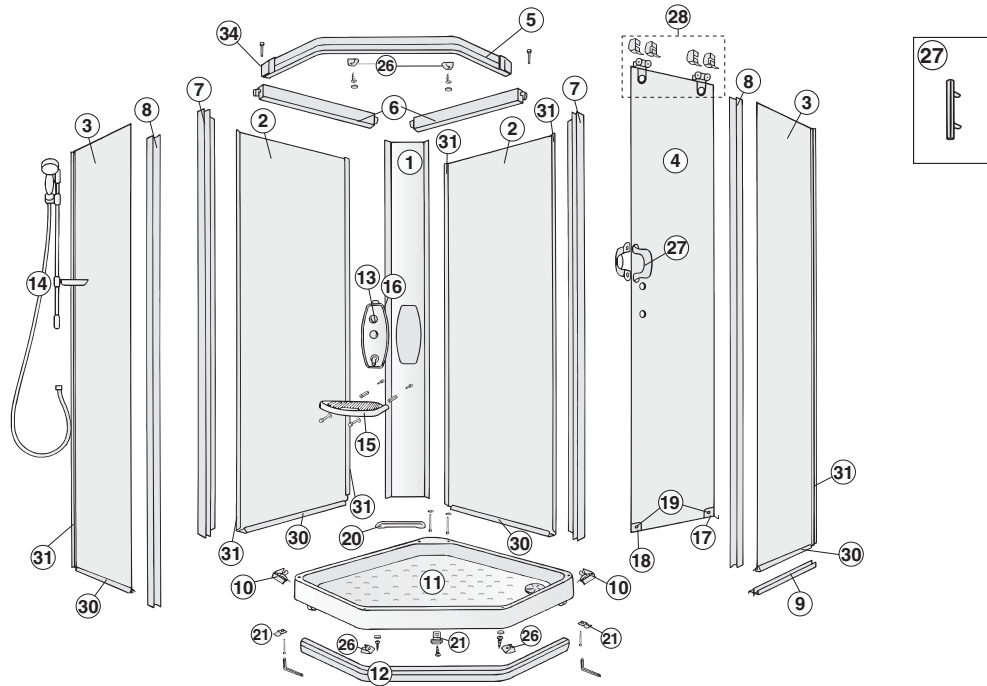
IDO SHOWERAMA - Suihkukaappi, Duschkabin, Shower cabin 6-5 (1999-2004)

	Tuote Produkt Product	LVI- numero VVS- nummer	Nimike Benämning Item	Suositus- hinta Riktpris Price 24 % euro	Suositus- hinta Riktpris Price 0 % euro	EAN
8	Z200006001	5841597	Tiivistesarja, täydellinen • Listsats komplett • Sealing kit complete	105,50	85,05	
10						
16						
20						
30						
31						
14	Z200016001	5841603	Suihkusetti, täydellinen • Duschset komplett • Shower set complete	58,60	47,25	
17	Z200004001	5854409	Ohjuripakkaus • Dörrstyrningssats • Steering kit	10,40	8,40	
18						
19						
21	Z7110001	5841688	Altaan pyöräsarja, täydellinen • Hjul för kabinkar, komplett Wheel set for shower tray, complete	43,00	34,65	
25	Z7292001	5854483	Vesilukko+poistoputki ø 40 • Avloppssats komplett ø 40 Outlet set complete ø 40	35,20	28,35	
26	Z5603001	5854408	Lasipidike (2 vasen, 2 oikea) • Glasanhållsats (2 vänster, 2 höger) Glass stop (2 left, 2 right)	14,30	11,55	
27	Z7180001	5861392	Vedin, täydellinen • Dörrhandtag, komplett • Door handle, complete	27,30	22,05	
28	Z200005001	5854410	Pyöräsarja, täydellinen • Hjulupphängningssats, komplett • Wheel kit, complete	44,30	35,70	
32						
28	Z5148001	5841730	Pyörä ø 21 (4 kpl) • Hjul ø 21 mm (4 st) • Wheel ø 21 mm (4 pcs)	13,00	10,50	
B						
34	Z200008001	5841599	Kulmahelat (oikea&vasen) • Hörnbeslag (vänster&höger) Corner fitting (right&left)	7,80	6,30	
8	Z5376001	5841596	Ovitiiviste, täydellinen • Dörrtätningsslistor komplett • Door sealing complete	29,90	24,15	

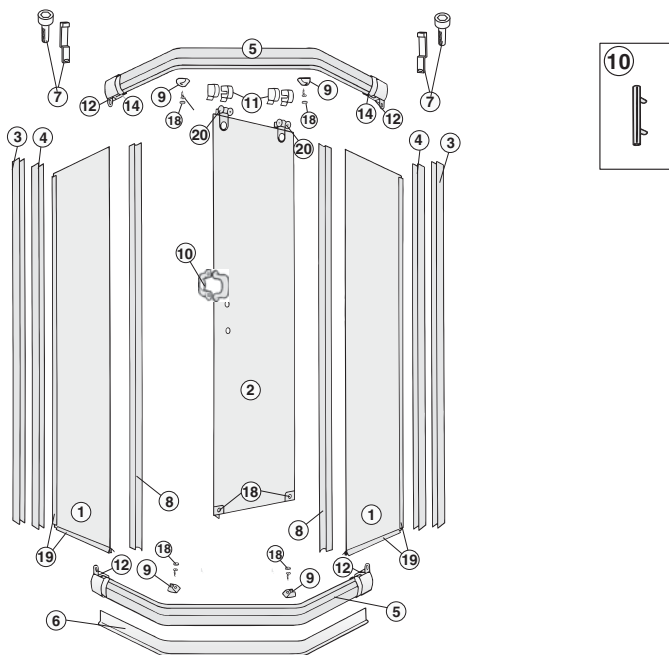
IDO SHOWERAMA - Suihkunurkka 6-3, Duschhörna 6-3, Corner shower model 6-3 (1999-2004)

	Tuote Produkt Product	LVI- numero VVS- nummer	Nimike Benämning Item	Suositus- hinta Riktpris Price 24 % euro	Suositus- hinta Riktpris Price 0 % euro	EAN
6	Z5361001	5854405	Lattiativiste, täydellinen • Golvättningslist för sockel, komplett Floor sealing, complete	29,90	24,15	
8	Z5376001	5841596	Ovitiiviste, täydellinen • Dörrättningslister komplett • Door sealing, complete	29,90	24,15	
9	Z5603001	5854408	Lasipidike (2 vasen, 2 oikea) • Glashållsatts (2 vänster, 2 höger) Glass stop (2 left, 2 right)	14,30	11,55	
10	Z7180001	5861392	Vedin, täydellinen • Dörrhandtag, komplett Door handle, complete	27,30	22,05	
11 20	Z20005001	5854410	Pyöräsarja, täydellinen • Hjulupphängningssats, komplett Wheel kit, complete	44,30	35,70	
14	Z200022001	5841734	Kulmahela • Hörnbeslag • Corner fittings	71,60	57,75	
20 B	Z5148001	5841730	Pyörä ø 21 (4 kpl) • Hjul ø 21 mm (4 st) Wheel ø 21 mm (4 pcs)	13,00	10,50	
18	Z200004001	5854409	Ohjuripakkaus • Dörrstyrningssats • Steering kit	10,40	8,40	
21	Z5634001	5861471	Oven pysäytin, 6-sarja • Dörrstopp, 6-serien • Door stopper, 6-series	13,00	10,50	

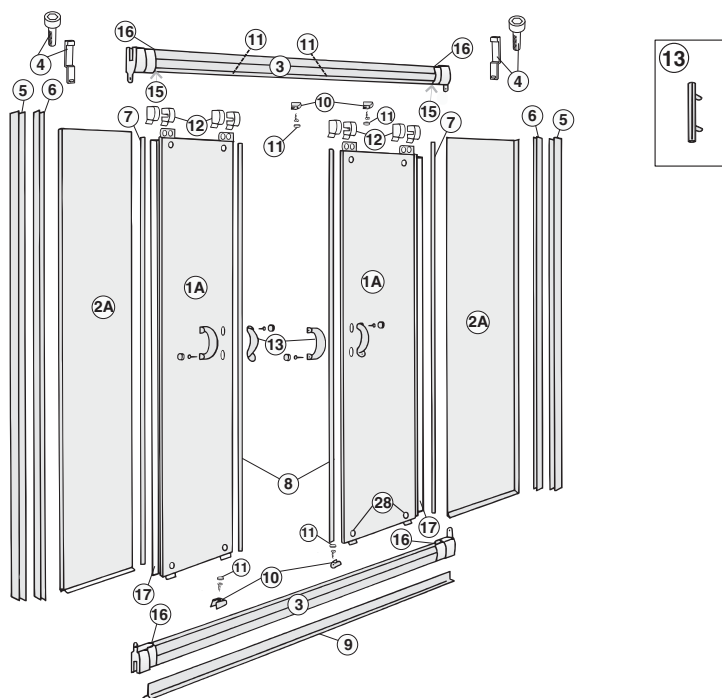

	Tuote Produkt Product	LVI- numero VVS- nummer	Nimike Benämning Item	Suositus- hinta Riktpris Price 24 % euro	Suositus- hinta Riktpris Price 0 % euro	EAN
7 - 17	Z200001001	5854394	Listasarja, täydellinen • Listsats, komplett • List kit, complete	57,30	46,20	
8	Z5273001	5854407	Magneettilista • Magnetlister • Magnetic list	45,60	36,75	
9	Z5361001	5854405	Lattiäviviste, täydellinen • Golvtättningslist för sockel, komplett Floor sealing, complete	29,90	24,15	
10 11	Z5603001	5854408	Lasipidike (2 vasen, 2 oikea) • Glasanhållssats (2 vänster, 2 höger) Glass stop (2 left, 2 right)	14,30	11,55	
12	Z200005001	5854410	Pyöräsarja, täydellinen • Hjulupphängningsats, komplett Wheel kit, complete	44,30	35,70	
12 B	Z5148001	5841730	Pyörä ø 21 (4 kpl) • Hjul ø 21 mm (4 st) Wheel ø 21 mm (4 pcs)	13,00	10,50	
13	Z7180001	5861392	Vedin, täydellinen • Dörrhandtag, komplett • Door handle, complete	27,30	22,05	
28	Z200004001	5854409	Ohjuripakkaus • Dörrstyrningssats • Steering kit	10,40	8,40	

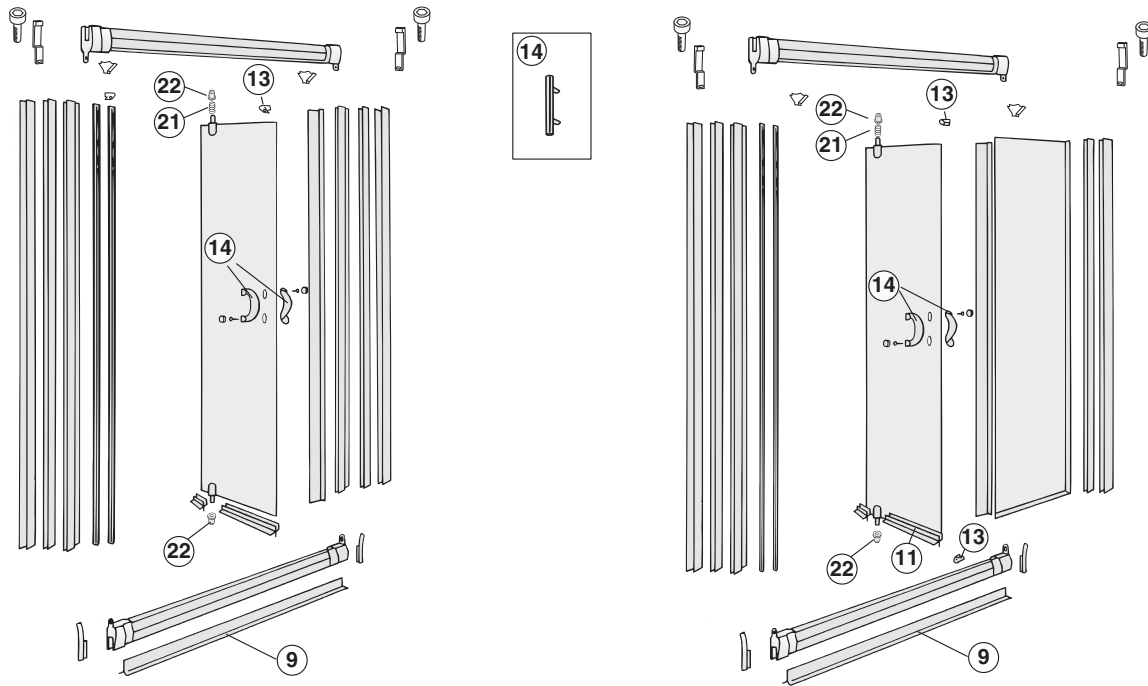
IDO SHOWERAMA - Kääntöovi 6-0, Svängdörr 6-0, Swing door modell 6-0 (1999-2004)
700-I 150 mm

	Tuote Produkt Product	LVI- numero VVS- nummer	Nimike Benämning Item	Suositus- hinta Riktpris Price 24 % euro	Suositus- hinta Riktpris Price 0 % euro	EAN
⑨	Z5361001	5854405	Lattiativiste, täydellinen • Golvtättningslist för sockel, komplett Floor sealing, complete	29,90	24,15	
⑪	Z5371001	5872312	Lattiativiste, 649 mm • Golvtättningslist, 649 mm • Floor sealing, 649 mm	14,30	11,55	
⑬	Z5603001	5854408	Lasipidike (2 vasen, 2 oikea) • Glasanhållsats (2 vänster, 2 höger) Glass stop (2 left, 2 right)	14,30	11,55	
⑭	Z7180001	5861392	Vedin, täydellinen • Dörrhandtag, komplett Door handle, complete	27,30	22,05	
⑳ ㉓	Z20000001	5854393	Jousi + holkki • Fjäder + bussning för pivot • Spring + socket	3,90	3,15	

IDO SHOWERAMA 61, 62, 63, 65 (-1999)

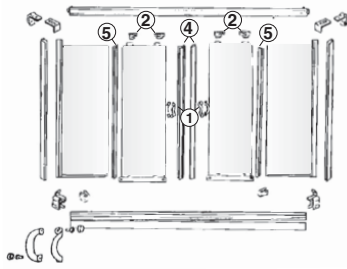

Showerama 61

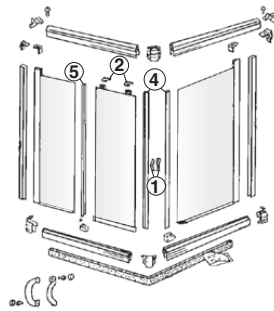



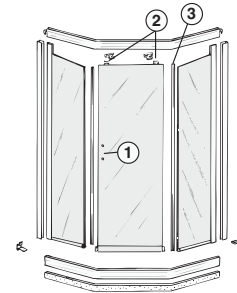
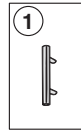

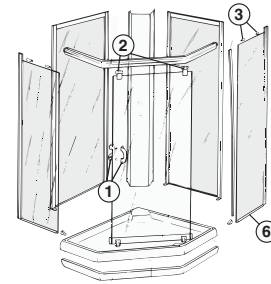

Showerama 62





















Showerama 63





















Showerama 65

	Tuote Produkt Product	LVI- numero VVS- nummer	Nimike Benämning Item	Suositus- hinta Riktpris Price 24 % euro	Suositus- hinta Riktpris Price 0 % euro	EAN
①	Z7180001	5861392	Vedin, täydellinen • Dörrhandtag, komplett Door handle, complete	27,30	22,05	
	Z5144001	5841731	Pyörä ø19 4 kpl • Hjul ø19 mm 4 st • Wheel ø19 mm 4 pcs	13,00	10,50	
	Z5376001	5841596	Ovitiiviste, täydellinen (63, 65) • Dörrtätninglister komplett (63, 65) Door sealing complete (63, 65)	29,90	24,15	
	Z5373001	5854479	Magneettilista (61, 62) • Magnetlister (61, 62) • Magnetic strips (61, 62)	35,20	28,35	
	Z200001001	5854394	Listasarja, täydellinen (61, 62) • Listsats, komplett (61, 62) List profile, complete (61, 62)	57,30	46,20	
	Z5325001	5854404	Tiiviste • Tätninglist • Sealing	27,30	22,05	













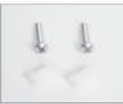







IDO TREVI 1400, 1500, 1600, 1700

	Tuote Produkt Product	LVI- numero VVS- nummer	Nimike Benämning Item	Suositus- hinta Riktpris Price 24 % euro	Suositus- hinta Riktpris Price 0 % euro	EAN
	Z0380480001	5811796	Pohjaventtiilin tulppa • Propp med kedja till badkar Plug w/chain + fixing for waste valve (Trevi 1400, 1500, 1600, 1700)	23,40	18,90	 713941184492991
	Z0473130001	5811790	Ammejalusta, jalkapuoli 1400 mm, täydellinen Fotställning fotända 1400 mm, komplett Leg system, complete 1400 mm, foot (Trevi 1400)	52,10	42,00	 713941184492371
	Z0827320001	5811795	Päätylevyn kiinnikkeet, valkoinen • Gavelfäste, vit Attachment for bathtub wall, white (Trevi 1400, 1500, 1600, 1700)	5,20	4,20	 713941184492821
	Z0827420001	5811794	Etumekanismi, täydellinen • Frontfäste+mekanismer komplett Front mechanism, complete (Trevi 1400, 1500, 1600, 1700)	28,60	23,10	 713941184492751
	Z94061001	5811767	Ammejalusta, jalkapuoli 1500-1600 mm, täydellinen Fotställning fotända 1500-1600 mm, komplett Leg system, complete 1500-1600 mm, head (Trevi 1500, 1600)	52,10	42,00	 713941184488101
	Z0830730001	5811789	Ammejalusta, pääpuoli 1700 mm, täydellinen Fotställning huvudända 1700 mm, komplett Leg system, complete 1700 mm, head (Trevi 1700)	52,10	42,00	 713941184492201
	Z0830830001	5811792	Ammejalusta, jalkapuoli 1700 mm, täydellinen Fotställning fotända 1700 mm, komplett Leg system complete 1700 mm, foot (Trevi 1700)	52,10	42,00	 713941184492511
	Z94063001	5811766	Ammejalusta, pääpuoli 1400 mm, täydellinen Fotställning huvudända 1400 mm, komplett Leg system, complete 1400 mm, head (Trevi 1400)	52,10	42,00	 713941184464031
	Z94064001	5811791	Ammejalusta, jalkapuoli 1500-1600 mm Fotställning fotända 1500-1600 mm Leg system complete 1500-1600 mm (Trevi 1500, 1600)	52,10	42,00	 713941184464411
	Z500032001	5811792	POP up täydellinen 14, 15, 16, 17 POP up komplett 14, 15, 16, 17 POP up complete 14, 15, 16, 17 (Trevi 1400, 1500, 1600, 1700)	37,20	30,00	

IDO SEVEN D 1400, 1500, 1600, 1700 • SEVEN D IMAGE 1600, 1700 • SEVEN D 95370 (nurkka/hörn/corner) • SEVEN D 95360, -61, -62, -63

	Tuote Produkt Product	LVI- numero VVS- nummer	Nimike Benämning Item	Suositus- hinta Riktpris Price 24 % euro	Suositus- hinta Riktpris Price 0 % euro	EAN
	Z9538001001	5811768	Etupaneeli • Badkarsfront • Front panel (Seven D 1400)	140,60	113,40	 7 1394118448568
	Z9538401001	5811772	Sivupaneeli (1400, 1500, 1600) Badkarsgavel (1400, 1500, 1600) Side panel (1400, 1500, 1600) (Seven D 1400, 1500, 1600)	75,50	60,90	 7 1394118448605
	Z9539500001	5811788	Viemäri- ja ylivuotojärjestelmä • Bräddavlopp • Overflow (Seven D 1400, 1500, 1600, 1700, 95370)	76,80	61,95	 7 1394118448766
	Z9540000001	5811780	Ammeen jalkaruuvi, muoviosa • Fotskruv för badkar Foot screw, nut, plastic part (Seven D 1400, 1500, 1600, 1700, 95370)	31,20	25,20	 7 1394118448881
	Z9540100001	5811781	Paneelin ylempi säätöruuvi, muoviosa • Övre skruv badkar Upper screw, nut, plastic part (Seven D 1400, 1500, 1600, 1700, 95370)	29,90	24,15	 7 1394118448698
	Z9540200001	5811782	Ammeen paneeli ruuvi, muoviosa • Skruv för panel badkar Panel screw, nut, plastic part (Seven D 1400, 1500, 1600, 1700, 95370)	29,90	24,15	 7 1394118448704
	Z9540300001	5811783	Paneelin kiinnitysjoussi • Fjäder för panel badkar Panel spring (Seven D 1400, 1500, 1600, 1700, 95370)	41,70	33,60	 7 1394118448711
	Z9540400001	5811784	Muoviosat paneelin kiinnitykseen • Plastfästen för badkarspaneler Plastic parts for panel fixation (Seven D 1400, 1500, 1600, 1700, 95370)	33,90	27,30	 7 1394118448728
	Z9540500001	5811785	Puiset tukipalat • Träklossar badkar • Wooden blocks (Seven D 1400, 1500, 1600, 1700, 95370)	29,90	24,15	 7 1394118448735





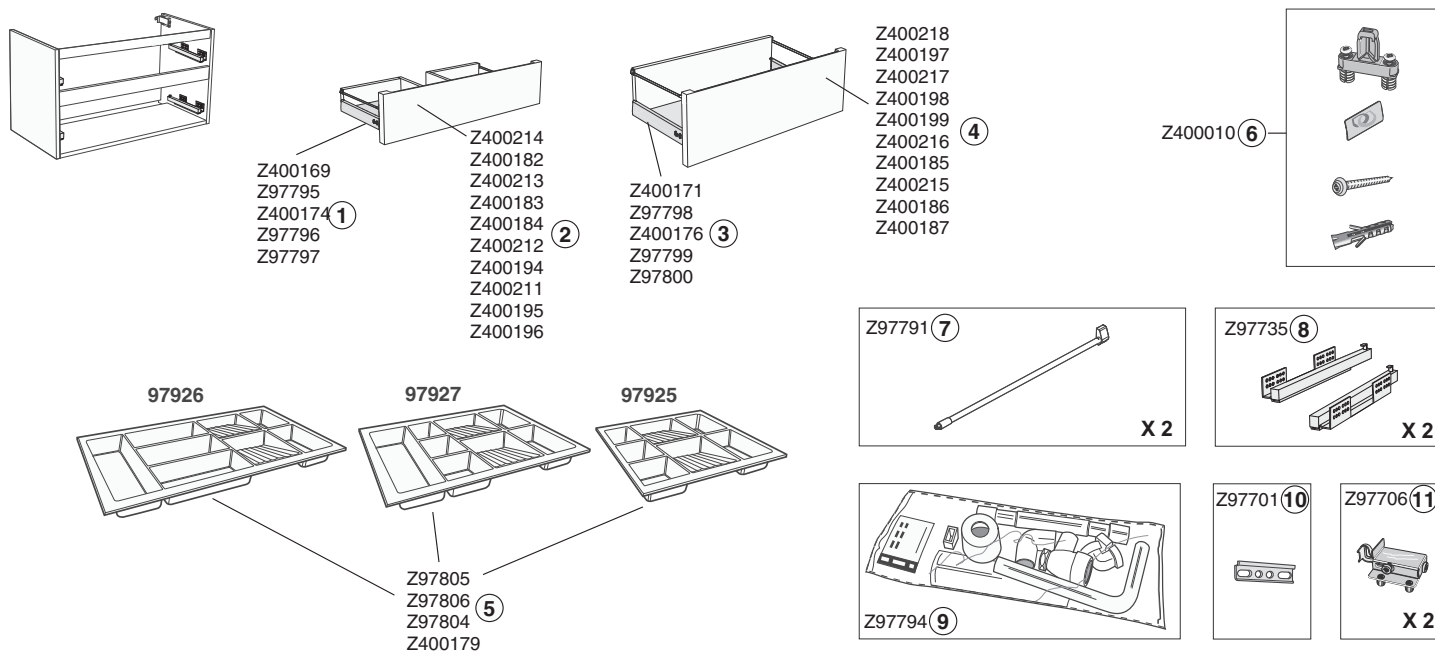

















IDO SEVEN D 1400, 1500, 1600, 1700 • SEVEN D IMAGE 1600, 1700 • SEVEN D 95370 (nurkka/hörn/corner) • SEVEN D 95360, -61, -62, -63

	Tuote Produkt Product	LVI- numero VVS- nummer	Nimike Benämning Item	Suositus- hinta Riktpris Price 24 % euro	Suositus- hinta Riktpris Price 0 % euro	EAN
	Z9540600001	5811786	Sivupaneelikiinnitys • Fixering för gavel Side panel fixation (Seven D 1400, 1500, 1600, 1700, 95370)	31,20	25,20	 7 1394118448742
	Z9540700001	5811787	Ylempi paneelin kiinnitys • Fixering för sidopanel Upper side panel fixation (Seven D 1400, 1500, 1600, 1700, 95370)	29,90	24,15	 7 1394118448759
	Z9538301001	5811771	Etupaneeli • Badkarsfront • Front panel (Seven D 1700)	166,70	134,40	 7 1394118448899
	Z9538501001	5811773	Sivupaneeli • Badkarsgavel • Side panel (Seven D 1700)	75,50	60,90	 7 1394118448612
	Z9532000001	5731321	Image amme ylivuotojärjestelmä Image bräddavlopp för badkar Image bathtub overflow (Seven D Image 1600, 1700)	183,60	148,05	 6 4416129436439
	Z9539101001	5811779	Kulma-ammeen etupaneeli (B3) • Panel för hörnbadkar (B3) Corner panel (B3) (Seven D 95370)	186,20	150,15	 7 1394118448674
	Z9538701001	5811775	Amme epäsym. paneeli (B3) 150 l, vasen Assymetrisk front (B3) 150 l, vänster Asymmetric panel (B3) 150 l, left (Seven D 95361)	166,70	134,40	 7 1394118448636
	Z9538601001	5811774	Amme epäsym. paneeli (B3) 150 l, oikea Assymetrisk front (B3) 150 l, höger Asymmetric panel (B3) 150 l, right (Seven D 95360)	166,70	134,40	 7 1394118448629
	Z9538901001	5811777	Amme epäsym. paneeli (B3) 160 l, vasen Assymetrisk front (B3) 160 l, vänster Asymmetric panel (B3) 160 l, left (Seven D 95363)	186,20	150,15	 7 1394118448650
	Z9538801001	5811776	Amme epäsym. paneeli (B3) 160 l, oikea Assymetrisk front (B3) 160 l, höger Asymmetric panel (B3) 160 l, right (Seven D 95362)	186,20	150,15	 7 1394118448643

IDO SEVEN D - Alakaappi, Underskåp, Base cabinet 97923, 97924, 97925, 97926, 97927

	Tuote Produkt Product	LVI- numero VVS- nummer	Nimike Benämning Item	Suositus- hinta Riktpris Price 24 % euro	Suositus- hinta Riktpris Price 0 % euro	EAN
1	Z400169001		Ylälaatikko 600 mm, valkoinen • Övre låda 600 mm, vit Upper drawer 600 mm, white (97924)	67,70	54,60	6441612945910791
	Z97795001		Ylälaatikko 800 mm, valkoinen • Övre låda 800 mm, vit Upper drawer 800 mm, white (97925)	91,10	73,50	6441612945858011
	Z400174001		Ylälaatikko 900 mm, valkoinen • Övre låda 900 mm, vit Upper drawer 900 mm, white (97923)	74,20	59,85	6441612945911851
	Z97796001		Ylälaatikko 1000 mm, valkoinen • Övre låda 1000 mm, vit Upper drawer 1000 mm, white (97926)	100,30	80,85	6441612945858491
	Z97797001		Ylälaatikko 1200 mm, valkoinen • Övre låda 1200 mm, vit Upper drawer 1200 mm, white (97927)	76,80	61,95	6441612945858701
2	Z400214001	6015160	Ylempi laatikonpää 600 mm, musta saarni • Övre lådfront 600 mm, svart ask Upper drawer end 600 mm, black ash (97924)	129,00	104,00	6441612943715581
	Z400182001	6015128	Ylempi laatikonpää 800 mm, musta saarni • Övre lådfront 800 mm, svart ask Upper drawer end 800 mm, black ash (97925)	132,70	107,00	6441612943712371
	Z400213001	6015159	Ylempi laatikonpää 900 mm, musta saarni • Övre lådfront 900 mm, svart ask Upper drawer end 900 mm, black ash (97923)	140,10	113,00	6441612943715411
	Z400183001	6015129	Ylempi laatikonpää 1000 mm, musta saarni • Övre lådfront 1000 mm, svart ask Upper drawer end 1000 mm, black ash (97926)	143,80	116,00	6441612943712441
	Z400184001	6015130	Ylempi laatikonpää 1200 mm, musta saarni • Övre lådfront 1200 mm, svart ask Upper drawer end 1200 mm, black ash (97927)	158,70	128,00	6441612943712511
	Z400212001	6015158	Ylempi laatikonpää 600 mm, valkoinen • Övre lådfront 600 mm, vit Upper drawer end 600 mm, white (97924)	106,60	86,00	6441612943715341
	Z400194001	6015140	Ylempi laatikonpää 800 mm, valkoinen • Övre lådfront 800 mm, vit Upper drawer end 800 mm, white (97925)	114,10	92,00	6441612943713501
	Z400211001	6015157	Ylempi laatikonpää 900 mm, valkoinen • Övre lådfront 900 mm, vit Upper drawer end 900 mm, white (97923)	121,50	98,00	6441612943715271
	Z400195001	6015141	Ylempi laatikonpää 1000 mm, valkoinen • Övre lådfront 1000 mm, vit Upper drawer end 1000 mm, white (97926)	125,20	101,00	6441612943713671
	Z400196001	6015142	Ylempi laatikonpää 1200 mm, valkoinen • Övre lådfront 1200 mm, vit Upper drawer end 1200 mm, white (97927)	140,10	113,00	6441612943713741
	3	Z400171001		Alalaatikko 600 mm, valkoinen • Undre låda 600 mm, vit Bottom drawer 600 mm, white (97924)	76,80	61,95
Z97798001			Alalaatikko 800 mm, valkoinen • Undre låda 800 mm, vit Bottom drawer 800 mm, white (97925)	72,90	58,80	6441612945858181

IDO SEVEN D - Alakaappi, Underskåp, Base cabinet 97923, 97924, 97925, 97926, 97927

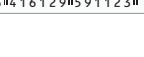
	Tuote Produkt Product	LVI- numero VVS- nummer	Nimike Benämning Item	Suositus- hinta Riktpris Price 24 % euro	Suositus- hinta Riktpris Price 0 % euro	EAN	
3	Z40017600I		Alalaatikko 900 mm, valkoinen • Undre låda 900 mm, vit Bottom drawer 900 mm, white (97923)	83,30	67,20		
	Z9779900I		Alalaatikko 1000 mm, valkoinen • Undre låda 1000 mm, vit Bottom drawer 1000 mm, white (97926)	79,40	64,05		
	Z9780000I		Alalaatikko 1200 mm, valkoinen • Undre låda 1200 mm, vit Bottom drawer 1200 mm, white (97927)	84,60	68,25		
4	Z40021800I	6015164	Alempi laatikonpää 600 mm, valkoinen • Undre lådfront 600 mm, vit Bottom drawer end 600 mm, white (97924)	166,20	134,00		
	Z40019700I	6015143	Alempi laatikonpää 800 mm, valkoinen • Undre lådfront 800 mm, vit Bottom drawer end 800 mm, white (97925)	173,60	140,00		
	Z40021700I	6015163	Alempi laatikonpää 900 mm, valkoinen • Undre lådfront 900 mm, vit Bottom drawer end 900 mm, white (97923)	181,00	146,00		
	Z40019800I	6015144	Alempi laatikonpää 1000 mm, valkoinen • Undre lådfront 1000 mm, vit Bottom drawer end 1000 mm, white (97926)	188,50	152,00		
	Z40019900I	6015145	Alempi laatikonpää 1200 mm, valkoinen • Undre lådfront 1200 mm, vit Bottom drawer end 1200 mm, white (97927)	214,50	173,00		
	Z40021600I	6015162	Alempi laatikonpää 600 mm, musta saarni • Undre lådfront 600 mm, svart ask Bottom drawer end 600 mm, black ash (97924)	184,80	149,00		
	Z40018500I	6015131	Alempi laatikonpää 800 mm, musta saarni • Undre lådfront 800 mm, svart ask Bottom drawer end 800 mm, black ash (97925)	117,80	95,00		
	Z40021500I	6015161	Alempi laatikonpää 900 mm, musta saarni • Undre lådfront 900 mm, svart ask Bottom drawer end 900 mm, black ash (97923)	199,60	161,00		
	Z40018600I	6015132	Alempi laatikonpää 1000 mm, musta saarni • Undre lådfront 1000 mm, svart ask Bottom drawer end 1000 mm, black ash (97926)	207,10	167,00		
	Z40018700I	6015133	Alempi laatikonpää 1200 mm, musta saarni • Undre lådfront 1200 mm, svart ask Bottom drawer end 1200 mm, black ash (97927)	233,10	188,00		
	5	Z9780500I		Laatikon sisusta 248x425 mm, valkoinen • Lådinsats 248x270 mm, vit Drawer insertion 248x425 mm, white (97926)	46,90	37,80	
		Z9780600I		Laatikon sisusta 248x388 mm, valkoinen • Lådinsats 248x388 mm, vit Drawer insertion 248x388 mm, white (97927)	41,70	33,60	
Z9780400I			Laatikon sisusta 248x270 mm, valkoinen • Lådinsats 248x270 mm, vit Drawer insertion 248x270 mm, white (97924, 97925)	45,60	36,75		
Z40017900I			Laatikon sisusta 900 mm • Lådinsats 900 mm Drawer interiors upper drawer 900 mm (97923)	50,80	40,95		
6	Z40001000I		Etusarjan kiinnityshelat • Monteringssats för front Fittings for front mounting	52,10	42,00		
7	Z9779100I		Kisko 275 mm, valkoinen • Reling 275 mm, vit • Rail 275 mm, white	43,00	34,65		
8	Z9773500I		Alalaatikon kiskot, V+O • Utdragsskenor låda, V+H • Rails drawers, L+R	104,20	84,00		
9	Z9779400I		Vesilukko • Vattenlås • Water trap	41,70	33,60		
10	Z9770100I		Helakisko 260 mm • Monteringsskena 260 mm Mounting rail 260 mm	26,00	21,00		
11	Z9770600I		Kiinnityshelat, V+O • Upphångningsbeslag i skåp, V+H • Suspension fittings, L+R	31,20	25,20		
	Z40017300I		Asennuspaketti 600, 900 • Monteringssats 600, 900 Mounting kit 600, 900	31,20	25,20		

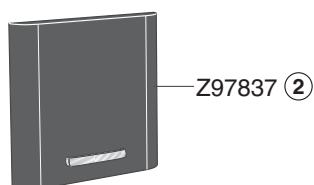
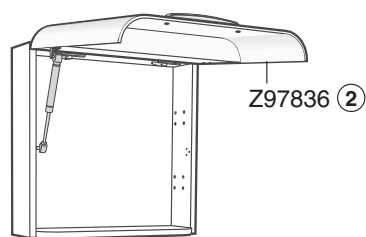
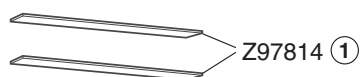
IDO SEVEN D - Yläkaappi, Överskåp, Upper cabinet 97911

Z400016 ③

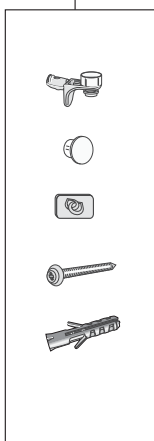

Z97807 ④

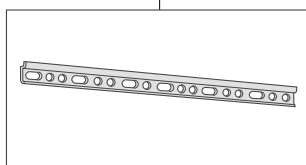

Z97834 ⑤

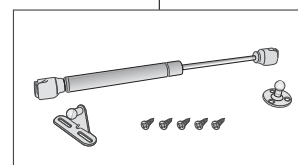

Z400019 ⑥

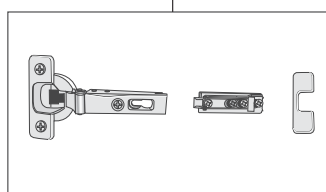

Z97706 ⑦

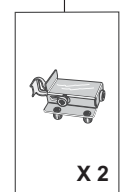

Z400011 ⑧

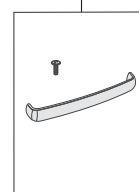

	Tuote Produkt Product	LVI- numero VVS- nummer	Nimike Benämning Item	Suositus- hinta Riktpris Price 24 % euro	Suositus- hinta Riktpris Price 0 % euro	EAN
①	Z97814001		Lasihylly 467x80 • Glashylla 467x80 • Glass shelf 467x80	29,90	24,15	6441612915857264
②	Z97836001		Ovi, valkoinen • Lucka, vit • Door, white	144,50	116,55	6441612915860994
	Z97837001		Ovi, musta saarni • Lucka, svart ask • Door, black ash	144,50	116,55	6441612915861054
③	Z400016001		Asennussarja • Monteringssats • Mounting kit	35,20	28,35	6441612915860824
④	Z97807001		Helakisko 465 mm • Monteringsskena 465 mm • Mounting rail 465 mm	26,00	21,00	6441612915856964
⑤	Z97834001		Pumppu + asennussarja • Gaskolv + monteringsats Gas rod + mounting kit	50,80	40,95	6441612915860754
⑥	Z400019001		Saranat • Gångjärn, komplett • Hinge, complete	32,60	26,25	6441612915863104
⑦	Z97706001		Kiinnityshelat, V+O • Upphängningsbeslag i skåp, V+H • Suspension fittings, L+R	31,20	25,20	6441612915857644
⑧	Z400011001		Vedin 192 mm • Handtag 192 mm • Handle 192 mm	36,50	29,40	6441612915859174

IDO SEVEN D - Alakaappi, Underskåp, Base cabinet 97910

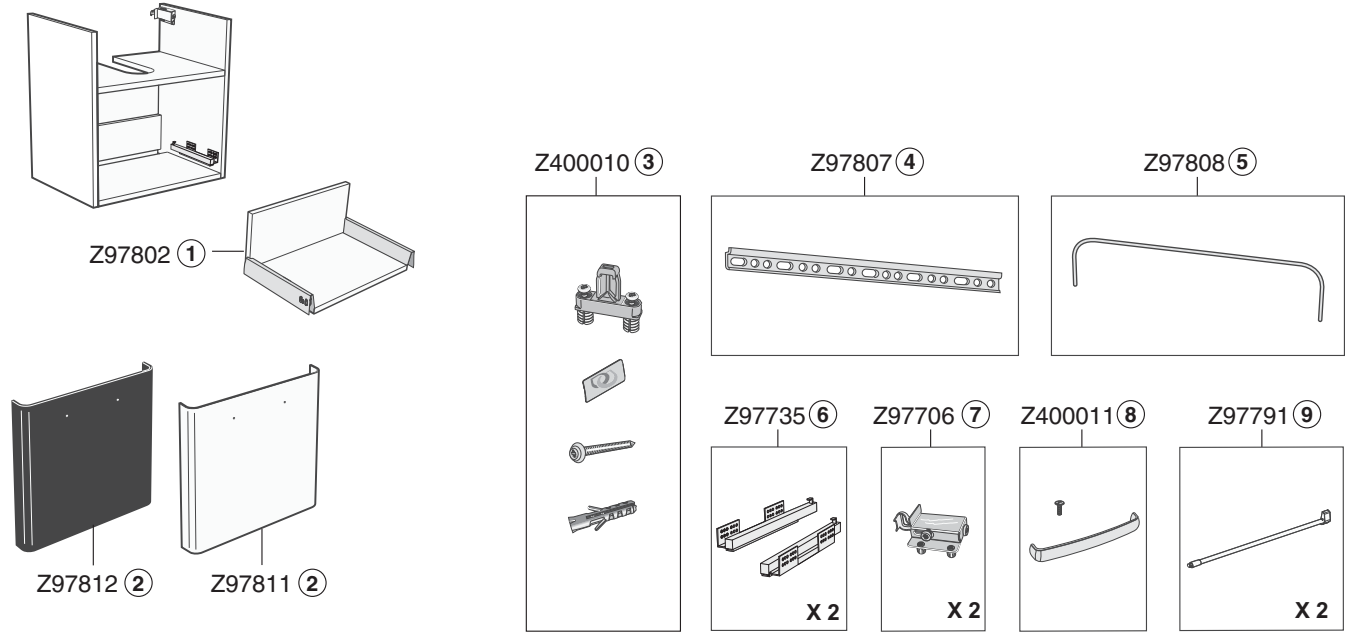

	Tuote Produkt Product	LVI- numero VVS- nummer	Nimike Benämning Item	Suositus- hinta Riktpris Price 24 % euro	Suositus- hinta Riktpris Price 0 % euro	EAN
①	Z97802001		Laatikosto 275 mm, valkoinen • Låda 275 mm, vit • Drawer 275 mm, white	87,20	70,35	
②	Z97811001		Ovi, valkoinen • Lucka, vit • Door, white	201,80	162,75	
	Z97812001		Ovi, musta saarni • Lucka, svart ask • Door, black ash	201,80	162,75	
③	Z400010001		Etusarjan kiinnityshelat • Monteringssats för front Fittings for front mounting	52,10	42,00	
④	Z97807001		Helakisko 465 mm • Monteringsskena 465 mm • Mounting rail 465 mm	26,00	21,00	
⑤	Z97808001		Laatikonpään tukitanko • Frontbygel • Frontbygel	35,20	28,35	
⑥	Z97735001		Alalaatikon kiskot,V+O • Utdragsskenor låda,V+H • Rails drawers, L+R	104,20	84,00	
⑦	Z97706001		Kiinnityshelat,V+O • Upphångningsbeslag i skåp,V+H • Suspension fittings, L+R	31,20	25,20	
⑧	Z400011001		Vedin 192 mm • Handtag 192 mm • Handle 192 mm	36,50	29,40	
⑨	Z97791001		Kisko 275 mm,V+O • Reling 275 mm,V+H • Rail 275 mm, L+R	43,00	34,65	

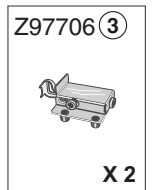
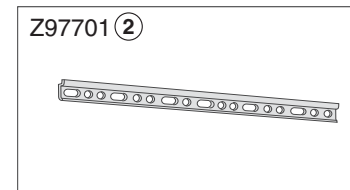
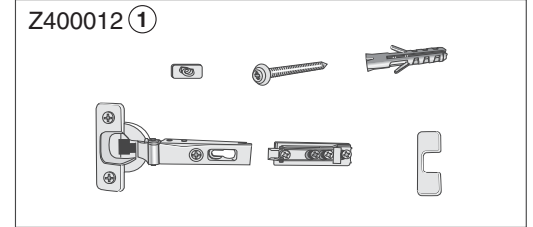
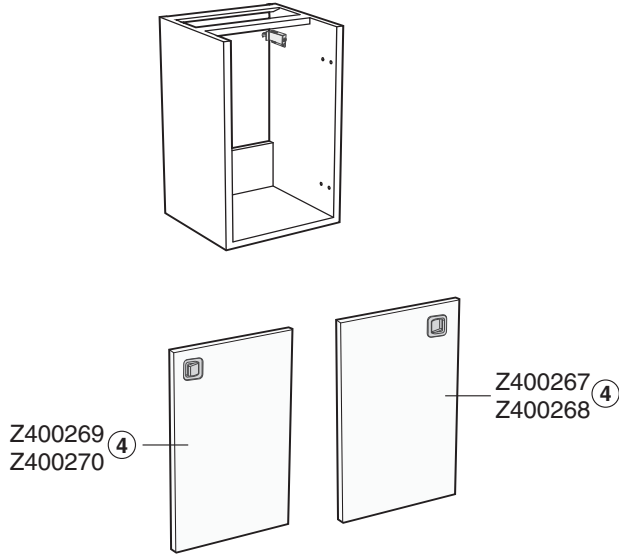
IDO SEVEN D - Alakaappi, Underskåp, Base cabinet 97930, 97931

	Tuote Produkt Product	LVI- numero VVS- nummer	Nimike Benämning Item	Suositus- hinta Riktpris Price 24 % euro	Suositus- hinta Riktpris Price 0 % euro	EAN
①	Z400012001		Saranoiden asennussarja • Komplet monteringsats inkluderande gångjärn Mounting kit with hinges	36,50	29,40	
②	Z97701001		Helakisko 260 mm • Monteringsskena 260 mm • Mounting rail 260 mm	26,00	21,00	
③	Z97706001		Kiinnityshelat,V+O • Upphängningsbeslag i skåp,V+H • Suspension fittings, L+R	31,20	25,20	
④	Z400267001	6015173	Ovi kulma-alakaapille 97930 vasen, valkoinen Lucka hörnunderskåp 97930 vänster, vit Door for corner base cabin 97930 left, white	114,10	92,00	
	Z400268001	6015174	Ovi kulma-alakaapille 97930 vasen, musta saarni Lucka hörnunderskåp 97930 vänster, svart ask Door for corner base cabin 97930 left, black ash	125,20	101,00	
	Z400269001	6015175	Ovi kulma-alakaapille 97931 oikea, valkoinen Lucka hörnunderskåp 97931 höger, vit Door for corner base cabin 97931 right, white	114,10	92,00	
	Z400270001	6015176	Ovi kulma-alakaapille 97931 oikea, musta saarni Lucka hörnunderskåp 97931 höger svart ask Door for corner base cabin 97931 right, black ash	125,20	101,00	

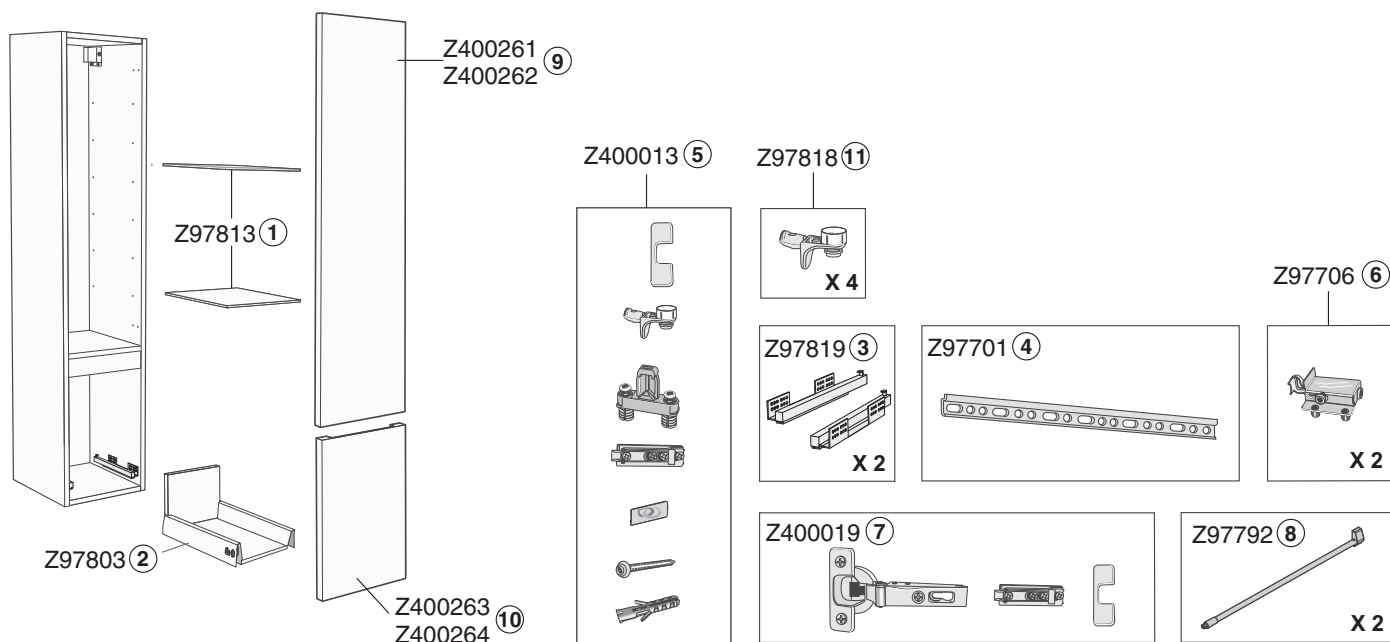
IDO SEVEN D - Korkeakaappi, Högsåp, High cabinet 98928

	Tuote Produkt Product	LVI- numero VVS- nummer	Nimike Benämning Item	Suositus- hinta Riktpris Price 24 % euro	Suositus- hinta Riktpris Price 0 % euro	EAN
①	Z97813001		Lasihylly 320x263 mm • Glashylla 320x263 mm • Glass shelf 320x263 mm	40,40	32,55	
②	Z97803001		Laatikosto 350 mm, valkoinen • Låda 350 mm, vit Drawer 350 mm, white	96,30	77,70	
③	Z97819001		Laatikon kisko 350 mm, V+O • Skena till låda 350 mm, V+H Rail for drawing 350 mm, L+R	93,70	75,60	
④	Z97701001		Helakisko 260 mm • Monteringskena 260 mm • Mounting rail 260 mm	26,00	21,00	
⑤	Z400013001		Asennussarja • Monteringsatts • Mounting kit	83,30	67,20	
⑥	Z97706001		Kiinnityshelat, V+O • Upphångningsbeslag i skåp, V+H • Suspension fittings, L+R	31,20	25,20	
⑦	Z400019001		Saranat • Gångjärn, komplett • Hinge, complete	32,60	26,25	
⑧	Z97792001		Kisko 350 mm, valkoinen • Reling 350 mm, vit • Rail 350 mm, white	48,20	38,85	
⑨	Z400261001	6015167	Ovi 295x1150 mm, valkoinen • Front 295x1150 mm, vit Door 295x1150 mm, white	188,50	152,00	
	Z400262001	6015168	Ovi 295x1150 mm, musta saarni • Front 295x1150 mm, svart ask Door 295x1150 mm, black ash	225,70	182,00	
⑩	Z400263001	6015169	Laatikonpää 445x295 mm, valk. • Lådfront 445x295 mm, vit Drawer end 445x295 mm, black ash	106,60	86,00	
	Z400264001	6015170	Laatikonpää 445x295 mm, musta saarni • Lådfront 445x295 mm, svart ask Drawer end 445x295 mm, black ash	121,50	98,00	
⑪	Z97818001		Lasihyllytuki • Glashyllbärare • Glass shelf support	6,50	5,25	

IDO SEVEN D - Yläkaappi, Överskåp, Upper cabinet 97905

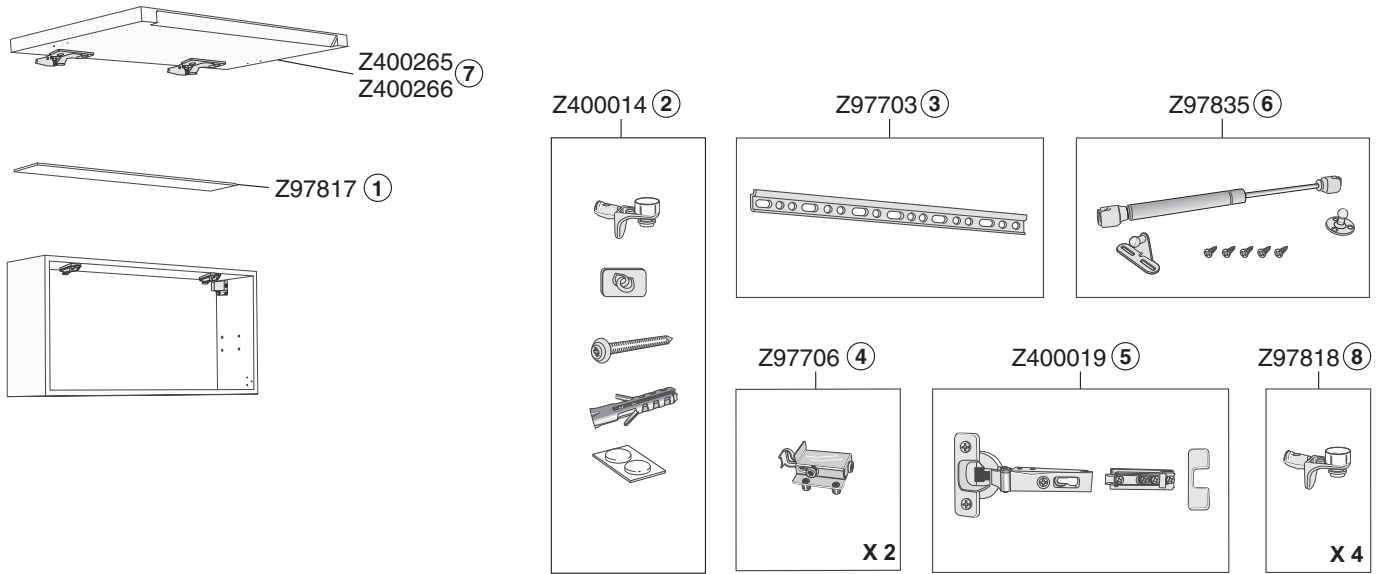

	Tuote Produkt Product	LVI- numero VVS- nummer	Nimike Benämning Item	Suositus- hinta Riktpris Price 24 % euro	Suositus- hinta Riktpris Price 0 % euro	EAN
①	Z97817001		Lasihylly 565x100 mm • Glashylla 565x100 mm Glass shelf 565x100 mm	37,80	30,45	
②	Z400014001		Asennussarja • Monteringsatts • Mounting kit	32,60	26,25	
③	Z97703001		Helakisko 560 mm • Monteringskena 560 mm • Mounting rail 560 mm	20,80	16,80	
④	Z97706001		Kiinnityshelat, V+O • Upphångningsbeslag i skåp, V+H • Suspension fittings, L+R	31,20	25,20	
⑤	Z400019001		Saranat • Gångjärn, komplett • Hinge, complete	32,60	26,25	
⑥	Z97835001		Pumppu + asennussarja • Gaskolv + monteringsatts Gas rod + mounting kit	50,80	40,95	
⑦	Z400265001	6015171	Nosto-ovi, valkoinen • Lucka överskåp, vit • Lift-up door, white	114,10	92,00	
	Z400266001	6015172	Nosto-ovi, musta saarni • Lucka överskåp, svart ask • Lift-up door, black ash	125,20	101,00	
⑧	Z97818001		Lasihyllytuki • Glashyllbärare • Glass shelf support	6,50	5,25	

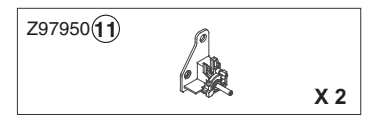
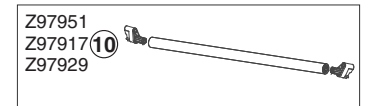
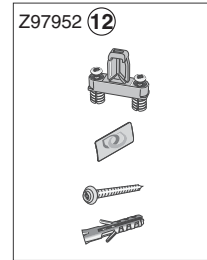
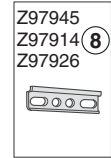
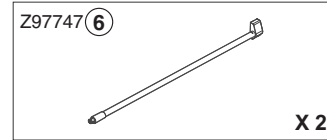
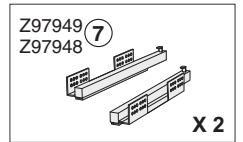
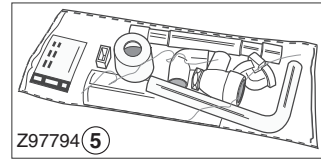
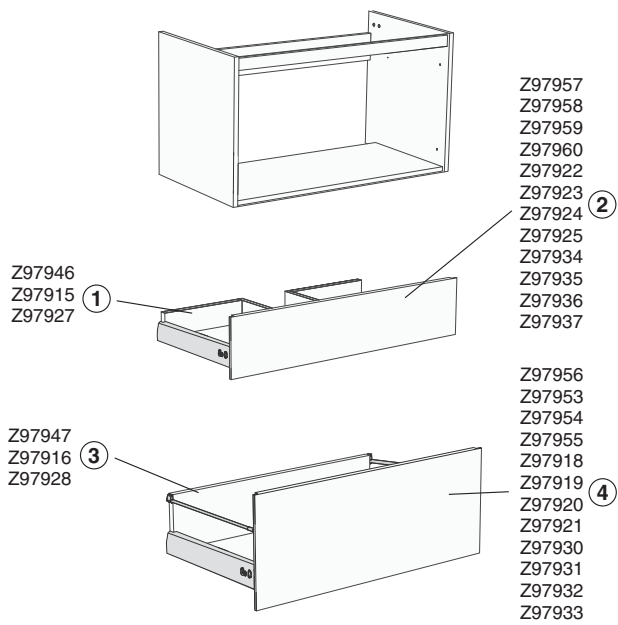
IDOTREND - Alakaappi, Underskåp, Base cabinet 97800, 97801, 97802

	Tuote Produkt Product	LVI- numero VVS- nummer	Nimike Benämning Item	Suositus- hinta Riktpris Price 24 % euro	Suositus- hinta Riktpris Price 0 % euro	EAN	
①	Z97946001		Ylälaatikosto 590 mm, harmaa • Övre låda 590 mm, grå Upper drawer 590 mm, grey (97800)	70,35	87,20		
	Z97915001		Ylälaatikosto 890 mm, harmaa • Övre låda 890, grå Upper drawer 890 mm, grey	72,90	58,80		
	Z97927001		Ylälaatikosto 1190 mm, harmaa • Övre låda 1190 mm, grå Upper drawer 1190 mm, grey (97802)	79,40	64,05		
②	Z97957001		Laatikonpää 586x170 mm, valkoinen • Lådfront 586x170 mm, vit Drawer end 586x170 mm, white (97800)	41,70	33,60		
	Z97958001		Laatikonpää 586x170 mm, harmaa • Lådfront 586x170 mm, grå Drawer end 586x170 mm, grey (97800)	41,70	33,60		
	Z97959001		Laatikonpää 586x170 mm, musta saarni • Lådfront 586x170 mm, svart ask Drawer end 586x170 mm, black ash (97800)	83,30	67,20		
	Z97960001		Laatikonpää 586x170 mm, jalava • Lådfront 586x170 mm, alm Drawer end 586x170 mm, elm (97800)	85,90	69,30		
	Z97972001		Laatikonpää 886x170 mm, valkoinen • Lådfront 886x170 mm, vit Drawer end 886x170 mm, white (97801)	97,70	78,75		
	Z97923001		Laatikonpää 886x170 mm, harmaa • Lådfront 886x170 mm, grå Drawer end 886x170 mm, grey (97801)	97,70	78,75		
	Z97924001		Laatikonpää 886x170 mm, musta saarni • Lådfront 886x170 mm, svart ask Drawer end 886x170 mm, black ash (97801)	97,70	78,75		
	Z97925001		Laatikonpää 886x170 mm, jalava • Lådfront 886x170 mm, alm Drawer end 886x170 mm, elm (97801)	97,70	78,75		
	Z97934001		Laatikonpää 1186x170 mm, valkoinen • Lådfront 1186x170 mm, vit Drawer end 1186x170 mm, white (97802)	97,70	78,75		
	Z97935001		Laatikonpää 1186x170 mm, harmaa • Lådfront 1186x170 mm, grå Drawer end 1186x170 mm, grey (97802)	97,70	78,75		
	Z97936001		Laatikonpää 1186x170 mm, musta saarni • Lådfront 1186x170 mm, svart ask • Drawer end 1186x170 mm, black ash (97802)	97,70	78,75		
	Z97937001		Laatikonpää 1186x170 mm, jalava • Lådfront 1186x170 mm, alm Drawer end 1186x170 mm, elm (97802)	97,70	78,75		
	③	Z97947001		Alalaatikosto 590 mm, harmaa • Undre låda 590 mm, grå Bottom drawer 590 mm, grey (97800)	79,40	64,05	
		Z97916001		Alalaatikosto 890 mm, harmaa • Undre låda 890 mm, grå Bottom drawer 890 mm, grey (97801)	87,20	70,35	

IDO TREND - Alakaappi, Underskåp, Base cabinet 97800, 97801, 97802

	Tuote Produkt Product	LVI- numero VVS- nummer	Nimike Benämning Item	Suositus- hinta Riktpris Price 24 % euro	Suositus- hinta Riktpris Price 0 % euro	EAN	
③	Z97928001		Alalaatikosto 1190 mm, harmaa • Undre låda 1190 mm, grå Bottom drawer 1190 mm, grey (97802)	88,50	71,40	644161295867301	
④	Z97953001		Laatikonpää 586x320 mm, valkoinen • Lådfront 586x320 mm, vit Drawer end 586x320 mm, white (97800)	70,30	56,70	644161295865181	
	Z97954001		Laatikonpää 586x320 mm, harmaa • Lådfront 586x320 mm, grå Drawer end 586x320 mm, grey (97800)	70,30	56,70	644161295865251	
	Z97955001		Laatikonpää 586x320 mm, musta saarni • Lådfront 586x320 mm, svart ask Drawer end 586x320 mm, black ash (97800)	100,30	80,85	644161295865321	
	Z97956001		Laatikonpää 586x320 mm, jalava • Lådfront 586x320 mm, alm Drawer end 586x320 mm, elm (97800)	100,30	80,85	644161295865491	
	Z97918001		Laatikonpää 886x320 mm, valkoinen • Lådfront 886x320 mm, vit Drawer end 886x320 mm, white (97801)	123,70	99,75	644161295866311	
	Z97919001		Laatikonpää 886x320 mm, harmaa • Lådfront 886x320 mm, grå Drawer end 886x320 mm, grey (97801)	123,70	99,75	644161295866481	
	Z97920001		Laatikonpää 886x320 mm, musta saarni • Lådfront 886x320 mm, svart ask Drawer end 886x320 mm, black ash (97801)	123,70	99,75	644161295866551	
	Z97921001		Laatikonpää 886x320 mm, jalava • Lådfront 886x320 mm, alm Drawer end 886x320 mm, elm (97801)	123,70	99,75	644161295866621	
	Z97930001		Laatikonpää 1186x320 mm, valkoinen • Lådfront 1186x320 mm, vit Drawer end 1186x320 mm, white (97802)	123,70	99,75	644161295867541	
	Z97931001		Laatikonpää 1186x320 mm, harmaa • Lådfront 1186x320 mm, grå Drawer end 1186x320 mm, grey (97802)	123,70	99,75	644161295867611	
	Z97932001		Laatikonpää 1186x320 mm, musta saarni • Lådfront 1186x320 mm, svart ask Drawer end 1186x320 mm, black ash (97802)	123,70	99,75	644161295867781	
	Z97933001		Laatikonpää 1186x320 mm, jalava • Lådfront 1186x320 mm, alm Drawer end 1186x320 mm, elm (97802)	123,70	99,75	644161295867851	
	⑤	Z97794001		Vesilukko • Vattenlås • Water trap	41,70	33,60	644161295857951
	⑥	Z97747001		Kiskosarja • Relingsatts • Rail kit	26,00	21,00	644161295861741
	⑦	Z97949001		Kisko 350 mm, ylälaatikosto, V+O • Lådskena 350 mm, övre låda, V+H Rail grass 350 mm, upper drawer, L+R	82,00	66,15	644161295864711
		Z97948001		Kisko 400 mm, alalaatikosto • Lådskena 400 mm, undre låda Rail grass 400 mm, bottom drawer	92,40	74,55	644161295864641
⑧	Z97945001		Helakisko 550 mm (97800) • Monteringsskena 550 mm (97800) Mounting rail 550 mm (97800)	26,00	21,00	644161295864331	
	Z97914001		Helakisko 850 mm (97801) • Monteringsskena 850 mm (97801) Mounting rail 850 mm (97801)	35,20	28,35	644161295865941	
	Z97926001		Helakisko 1150 mm (97802) • Monteringsskena 1150 mm (97802) Mounting rail 1150 mm (97802)	43,00	34,65	644161295867161	
	Z97706001		Kiinnityshelat, V+O • Upphångningsbeslag i skåp, V+H • Suspension fittings, L+R	31,20	25,20	644161295857641	
⑩	Z97951001		Kisko 459 mm (97800) • Skena 459 mm (97800) • Rail 459 mm (97800)	19,00	15,36	644161295864951	
	Z97967001		Kisko 759 mm (97801) • Skena 759 mm (97801) • Rail 759 mm (97801)	29,90	24,15	644161295897551	
	Z97929001		Kisko 1059 mm (97802) • Skena 1059 mm (97802) • Rail 1059 mm (97802)	44,30	35,70	644161295867471	
⑪	Z97950001		Sarana, V+O • Gångled, V+H • Mounting grass, L+R	41,70	33,60	644161295864881	
⑫	Z97952001		Asennussarja • Monteringssatts • Monteringssett	28,60	23,10	644161295865011	

IDOTREND - Korkeakaappi, Högskåp, High cabinet 97803

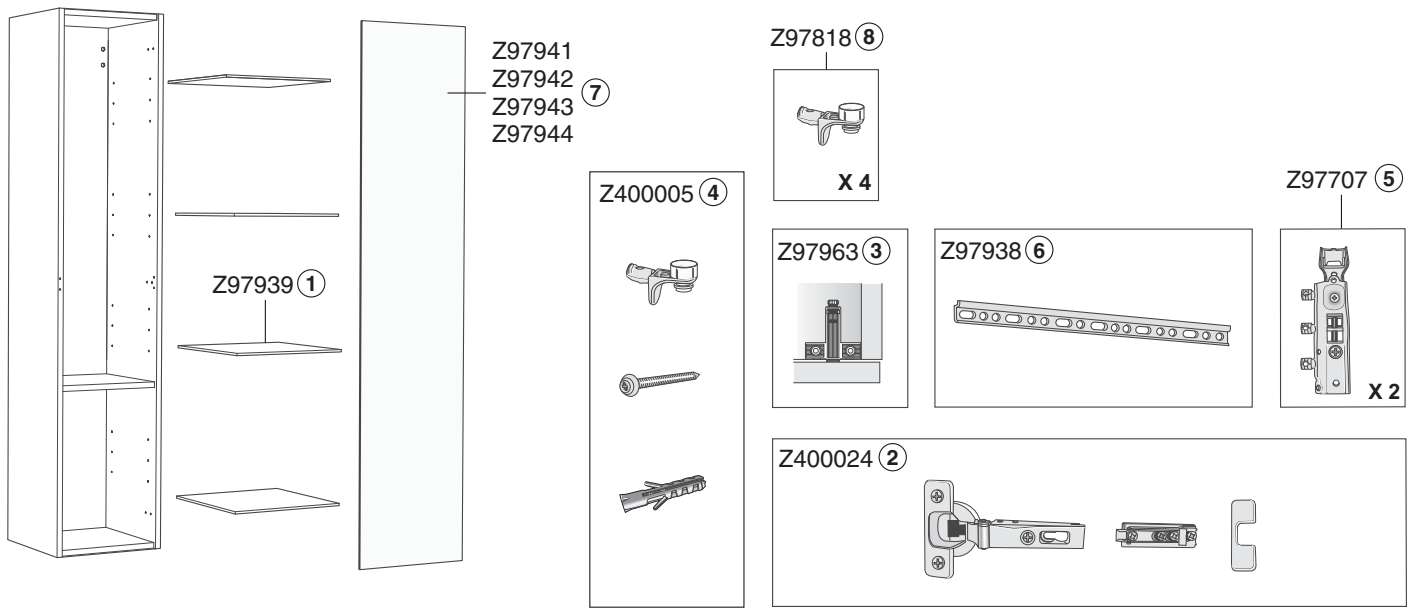

	Tuote Produkt Product	LVI- numero VVS- nummer	Nimike Benämning Item	Suositus- hinta Riktpris Price 24 % euro	Suositus- hinta Riktpris Price 0 % euro	EAN
①	Z97939001		Lasihylly 315x300 mm • Glashylla 315x300 mm • Glass shelf 315x300 mm	46,90	37,80	
②	Z400024001		Saranat • Gångjärn, komplett • Hinges complete	41,70	33,60	
③	Z97963001		Magneetti ja peitepala • Magnet och hölje • Magnet and cover	31,20	25,20	
④	Z400005001		Asennussarja • Monteringsatts • Mounting kit	100,30	80,85	
⑤	Z97707001		Kiinnityshelat, V+O • Upphängningsbeslag i skåp, V+H • Suspension fittings, L+R	19,50	15,75	
⑥	Z97938001		Helakisko 310 mm • Monteringskena 310 mm • Mounting rail 310 mm	18,20	14,70	
⑦	Z97941001		Ovi, valkoinen • Dörr, vit • Door, white	130,20	105,00	
	Z97942001		Ovi, harmaa • Dörr, grå • Door, grey	130,20	105,00	
	Z97943001		Ovi, musta saarni • Dörr, svart ask • Door, black ash	130,20	105,00	
	Z97944001		Ovi, jalava • Dörr, alm • Door, elm	130,20	105,00	
⑧	Z97818001		Lasihyllytuki • Glashyllbärare • Glass shelf support	6,50	5,25	

IDO SELECT - Yläkaappi, Överskåp, Upper cabinet 97604, 98604

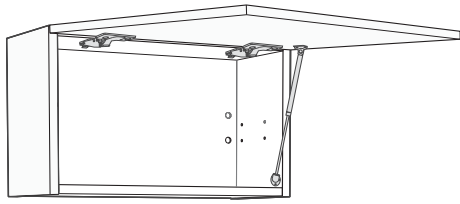

Z400035 (2)

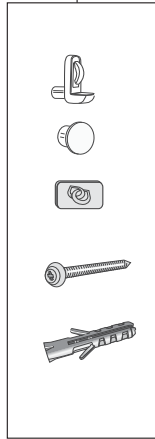

Z97702 (3)

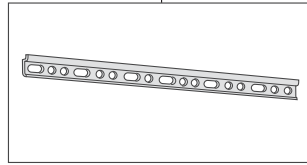

Z97772 (4)

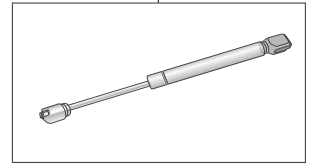

Z400019 (5)

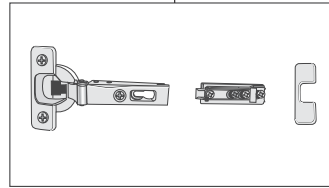

Z97707 (6)

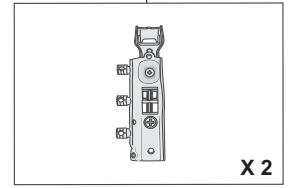

X 2

	Tuote Produkt Product	LVI- numero VVS- nummer	Nimike Benämning Item	Suositus- hinta Riktpris Price 24 % euro	Suositus- hinta Riktpris Price 0 % euro	EAN
(1)	Z97722001		Lasihylly 438x110 mm • Glashylla 438x110 mm • Glass shelf 438x110 mm	33,90	27,30	
(2)	Z400035001		Asennussarja • Monteringssats • Mounting kit	26,00	21,00	
(3)	Z97702001		Helakisko 440 mm • Monteringsskena 440 mm • Mounting rail 440 mm	20,80	16,80	
(4)	Z97772001		Pumppu + asennussarja • Gaskolv + monteringsats Gas rod + mounting kit	50,80	40,95	
(5)	Z400019001		Saranat • Gångjärn, komplett • Hinge, complete	32,60	26,25	
(6)	Z97707001		Kiinnityshelat, V+O • Upphängningsbeslag i skåp, V+H • Suspension fittings, L+R	19,50	15,75	

IDO SELECT - Korkeakaappi, Högskåp, High cabinet 97600, 98600

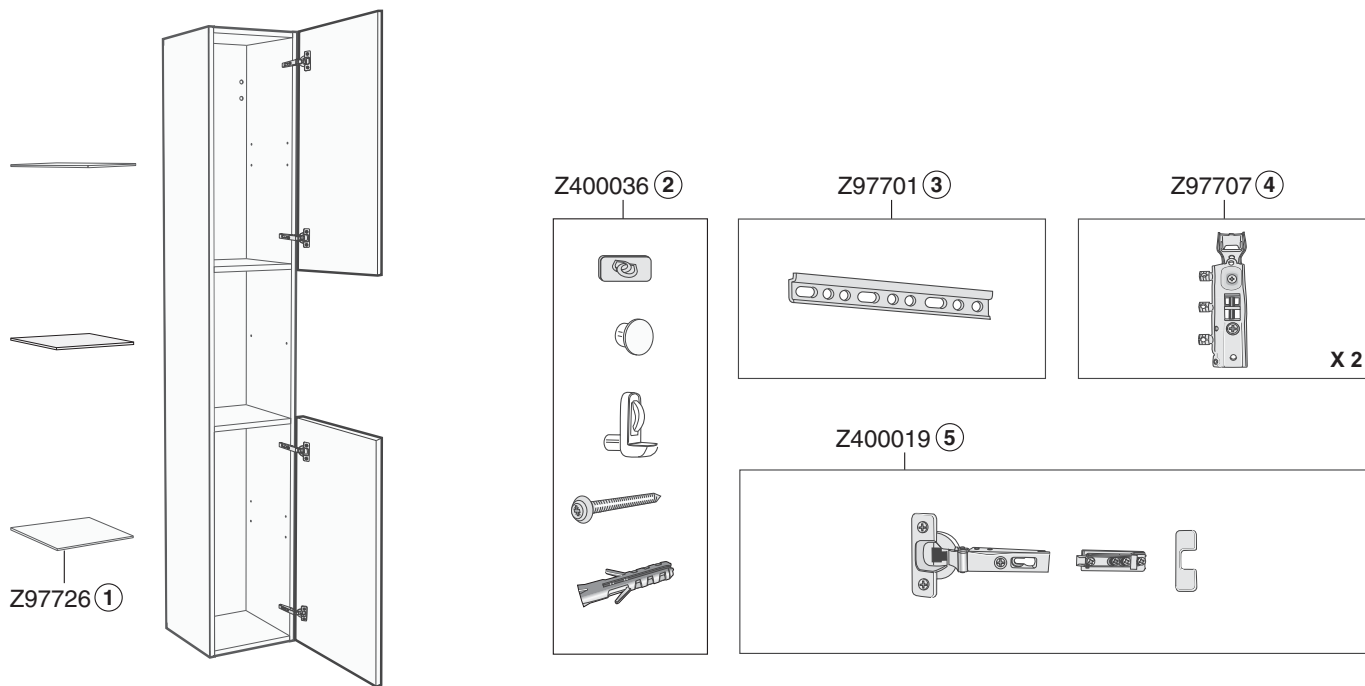

	Tuote Produkt Product	LVI- numero VVS- nummer	Nimike Benämning Item	Suositus- hinta Riktpris Price 24 % euro	Suositus- hinta Riktpris Price 0 % euro	EAN
①	Z97726001		Lasihylly 258x258 mm • Glashylla 258x258 mm • Glass shelf 258x258 mm	39,10	31,50	6441612945871644
②	Z400036001		Asennussarja • Monteringssats • Mounting kit	45,60	36,75	6441612945874924
③	Z97701001		Helakisko 260 mm • Monteringsskena 260 mm • Mounting rail 260 mm	26,00	21,00	6441612945857574
④	Z97707001		Kiinnityshelat, V+O • Upphångningsbeslag i skåp, V+H • Suspension fittings, L+R	19,50	15,75	6441612945854674
⑤	Z400019001		Saranat • Gångjärn, komplett • Hinge, complete	32,60	26,25	6441612945863104

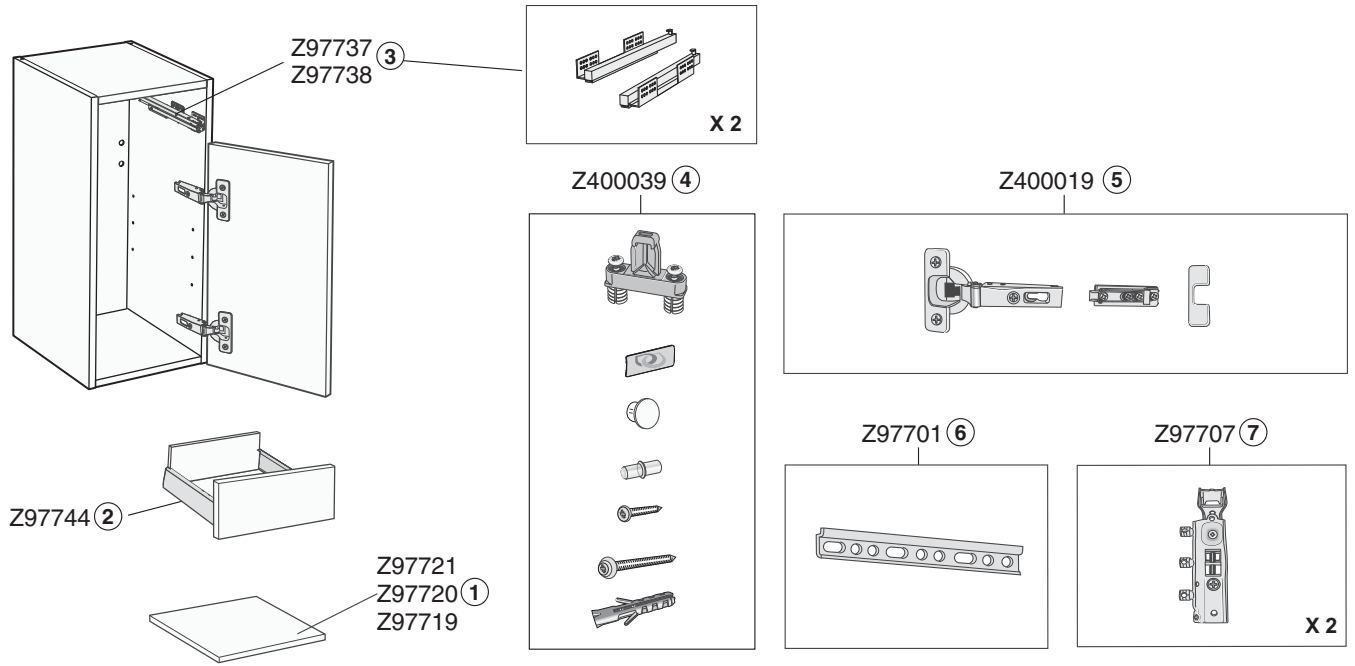
IDO SELECT - Sivukaappi, Sidoskåp, Side cabinet 98302, 98402, 98502

	Tuote Produkt Product	LVI- numero VVS- nummer	Nimike Benämning Item	Suositus- hinta Riktpris Price 24 % euro	Suositus- hinta Riktpris Price 0 % euro	EAN
①	Z97721001		Hylly 264x270 mm • Hylla 264x270 mm • Shelf 264x270 mm (98302)	18,20	14,70	
	Z97720001		Hylly 264x320 mm • Hylla 264x320 mm • Shelf 264x320 mm (98402)	18,20	14,70	
	Z97719001		Hylly 264x440 mm • Hylla 264x440 mm • Shelf 264x440 mm (98502)	18,20	14,70	
②	Z97744001		Laatikosto 98302, 98402 • Låda 98302, 98402 • Drawer 98302, 98402	75,50	60,90	
	Z97745001		Laatikosto, 98502 • Låda 98502 • Drawer, 98502	84,60	68,25	
③	Z97737001		Liukukisko, ylälaatikosto 98302, 98402, V+O • Utdragsskena övre låda 98302, 98402, V+H • Rail grass, upper drawer 98302, 98402, L+R	75,50	60,90	
	Z97738001		Liukukisko, ylälaatikosto 98502, V+O • Utdragsskena övre låda 98502, V+H Rail grass, upper drawer 98502, L+R	83,30	67,20	
④	Z400039001		Asennussarja • Monteringssats • Mounting kit	43,00	34,65	
⑤	Z400019001		Saranat • Gångjärn, komplett • Hinge, complete	32,60	26,25	
⑥	Z97701001		Helakisko 260 mm • Monteringsskena 260 mm • Mounting rail 260 mm	26,00	21,00	
⑦	Z97707001		Kiinnityshelat, V+O • Upphångningsbeslag i skåp, V+H • Suspension fittings, L+R	19,50	15,75	

IDO SELECT - Korkeakaappi, Högskåp, High cabinet 97601, 97602

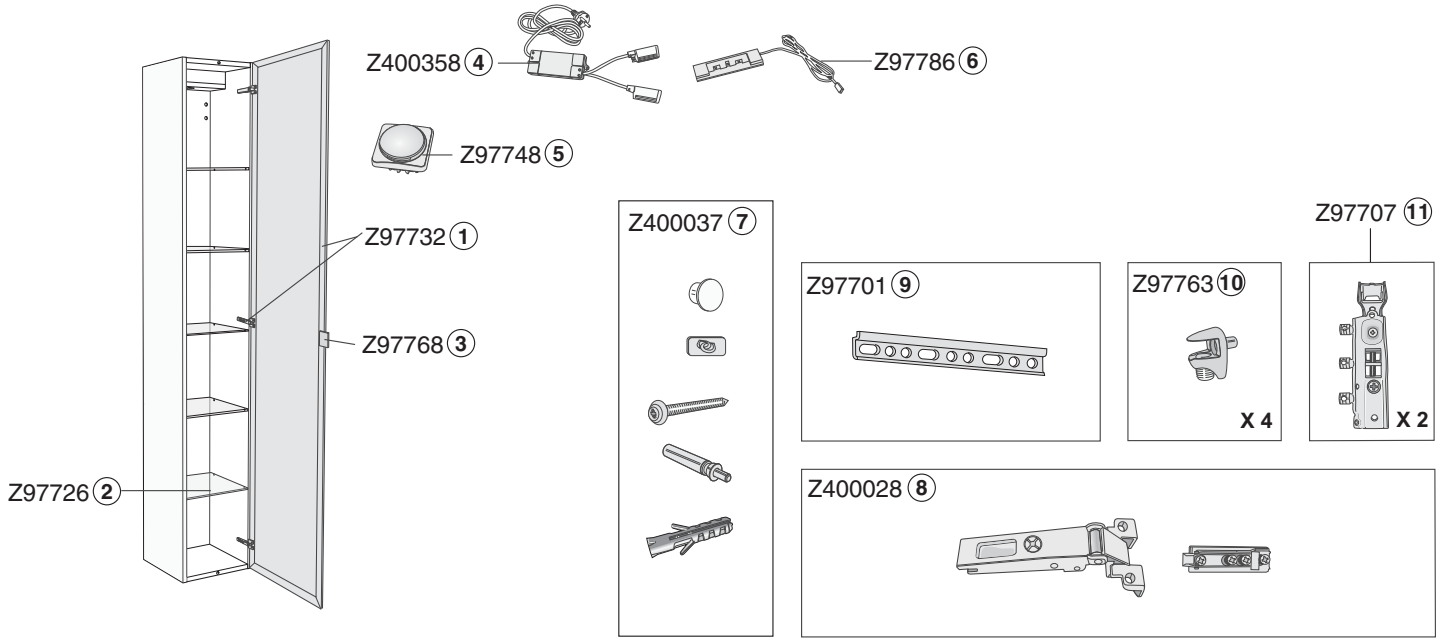

	Tuote Produkt Product	LVI- numero VVS- nummer	Nimike Benämning Item	Suositus- hinta Riktpris Price 24 % euro	Suositus- hinta Riktpris Price 0 % euro	EAN
①	Z97732001		Al.kehikon ovi 1824x295 mm (saranat+vedin) Dörr med al. ram 1824x295 mm Aluframe door 1824x295 mm (incl hinges+grip)	248,70	200,55	6 44 16 12 91 58 71 19 1
②	Z97726001		Lasihylly 258x258 mm • Glashylla 258x258 mm • Glass shelf 258x258 mm	39,10	31,50	6 44 16 12 91 58 71 64 1
③	Z97768001		Vedin al. kehikko-oveen • Handtag för dörr med al. ram • Grip for aluframe door	24,70	19,95	6 44 16 12 91 58 71 13 3
④	Z400358001		LED muuntaja • Transformator till LED • Transformer for LED	71,60	57,75	
⑤	Z97748001		Sähköpistoke täydellinen • Eluttag • Electrical outlet complete	76,80	61,95	6 44 16 12 91 58 71 57 1
⑥	Z97786001		LED-valo lasihyllyyn • LED-belysning till glashylla • LED for glass shelf	54,70	44,10	6 44 16 12 91 58 71 88 1
⑦	Z400037001		Asennussarja • Monteringssats • Mounting kit	40,40	32,55	6 44 16 12 91 58 71 50 8
⑧	Z400028001		Saranat • Gångjärn, komplett • Hinge, complete	28,60	23,10	6 44 16 12 91 58 71 26 1
⑨	Z97701001		Helakisko 260 mm • Monteringsskena 260 mm • Mounting rail 260 mm	26,00	21,00	6 44 16 12 91 58 57 57 1
⑩	Z97763001		Lasihyllyn tuki 4 kpl • Glashyllbärare med skruv för högskåp Shelf support complete 4 pcs	7,80	6,30	6 44 16 12 91 58 71 77 1
⑪	Z97707001		Kiinnityshelat,V+O • Upphängningsbeslag i skåp,V+H • Suspension fittings, L+R	19,50	15,75	6 44 16 12 91 58 54 67 1

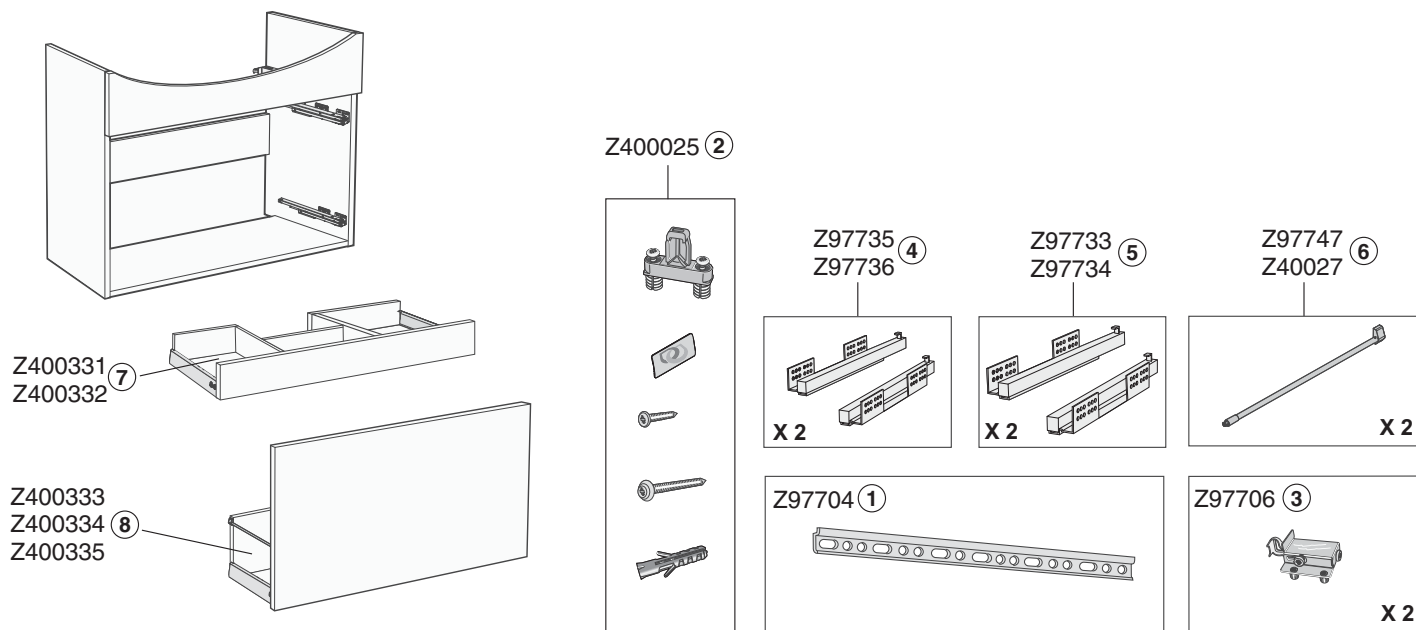
IDO SELECT - Alakaappi, Underskåp, Base cabinet 98303/97303, 97403, 97503

	Tuote Produkt Product	LVI- numero VVS- nummer	Nimike Benämning Item	Suositus- hinta Riktpris Price 24 % euro	Suositus- hinta Riktpris Price 0 % euro	EAN
①	Z97704001		Helakisko 885 mm • Monteringsskena 885 mm • Mounting rail 885 mm	35,20	28,35	6 44 16 12 9 5 8 7 3 2 4 1
②	Z400025001		Asennussarja • Monteringsatts • Mounting kit	33,90	27,30	6 44 16 12 9 5 8 6 9 2 1 1
③	Z97706001		Kiinnityshelat, V+O • Upphångningsbeslag i skåp, V+H • Suspension fittings, L+R	31,20	25,20	6 44 16 12 9 5 8 5 7 6 4 1
④	Z97735001		Alalaatikon kiskot, V+O • Utdragsskenor låda, V+H • Rails drawers, L+R 98303-403	104,20	84,00	6 44 16 12 9 5 8 5 8 3 2 1
	Z97736001		Alalaatikosto kiskot V+O • Utdragsskenor undre lådan, V+H Utdragsskenor lower drawer, L+R 98503	83,30	67,20	6 44 16 12 9 5 8 6 1 5 0 1
⑤	Z97733001		Ylälaatikosto kiskot, V+O • Utdragsskenor övre lådan, V+H Utdragsskenor upper drawer L+R 98303-403	58,60	47,25	6 44 16 12 9 5 8 6 1 6 7 1
	Z97734001		Ylälaatikosto kiskot, V+O • Utdragsskenor övre lådan, V+H Utdragsskenor upper drawer L+R 98503	67,70	54,60	6 44 16 12 9 5 8 6 9 3 8 1
⑥	Z97747001		Kiskosarja • Relingsatts • Rail kit 97503 / 98503	26,00	21,00	6 44 16 12 9 5 8 6 1 7 4 1
	Z977476001		Kiskosarja • Relingsatts • Rail kit 98303-403, 97303-403	26,00	21,00	
⑦	Z400331001	6014930	Ylälaatikko • Övre låda • Upper drawer 98303-403	91,80	74,00	6 44 16 12 9 5 8 5 5 1 9 1
	Z400332001	6014931	Ylälaatikko • Övre låda • Upper drawer 98503 / 97503	99,20	80,00	6 44 16 12 9 5 8 5 5 2 6 1
⑧	Z400333001	6014932	Alalaatikosto ilman etusarjaa • Undre låda utan front • Lower drawer, no end 98303 / 97303	99,20	80,00	6 44 16 12 9 5 8 5 5 3 3 1
	Z400334001	6014933	Alalaatikosto ilman etusarjaa • Undre låda utan front • Lower drawer, no end 98403 / 97403	99,20	80,00	6 44 16 12 9 5 8 5 5 4 0 1
	Z400335001	6014934	Alalaatikosto ilman etusarjaa • Undre låda utan front • Lower drawer, no end 98503 / 97503	106,60	86,00	6 44 16 12 9 5 8 5 5 3 3 1

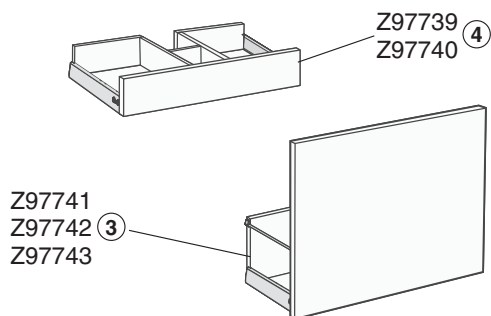
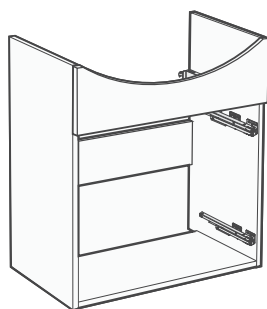
IDO SELECT Small, Medium, Large - Alakaappi, Underskåp, Base cabinet 97301/98301, 97401/98401, 97501/98501

Z400025 ⑤

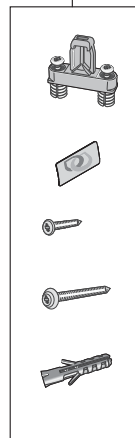
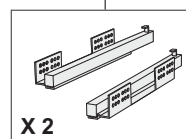
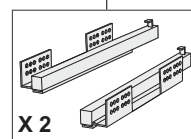
 Z97735 ②
Z97736

 Z97733 ①
Z97734

 Z97746 ⑥
Z97747

Z97706 ⑦

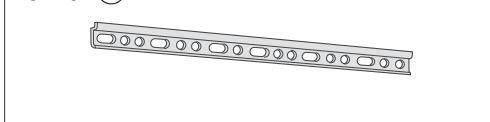

Z97704 ⑧



	Tuote Produkt Product	LVI- numero VVS- nummer	Nimike Benämning Item	Suositus- hinta Riktpris Price 24 % euro	Suositus- hinta Riktpris Price 0 % euro	EAN
①	Z97733001		Ylälaatikosto kiskot,V+O • Utdragsskenor övre lådan,V+H Utdragsskenor upper drawer L+R 97301/98301, 97401/98401	58,60	47,25	644161295861671
	Z97734001		Ylälaatikosto kiskot,V+O • Utdragsskenor övre lådan,V+H Utdragsskenor upper drawer L+R 97501/98501	67,70	54,60	644161295869381
②	Z97735001		Alalaatikon kiskot,V+O • Utdragsskenor låda,V+H • Rails drawers, L+R 97301/98301, 97401/98401	104,20	84,00	644161295858321
	Z97736001		Alalaatikosto kiskot • Utdragsskenor undre lådan Utdragsskenor lower drawer 97501/98501	83,30	67,20	644161295861501
③	Z97741001		Alalaatikosto ilman etu • Undre låda utan front • Lower drawer, no end 97301/98301	83,30	67,20	644161295869451
	Z97742001		Alalaatikosto ilman etu • Undre låda utan front • Lower drawer, no end 97401/98401	83,30	67,20	644161295869521
	Z97743001		Alalaatikosto ilman etu • Undre låda utan front • Lower drawer, no end 97501/98501	91,10	73,50	644161295869691
④	Z97739001		Ylälaatikosto • Övre låda • Upper drawer 97301/98301, 97401/98401	96,30	77,70	644161295869761
	Z97740001		Ylälaatikosto • Övre låda • Upper drawer 97501/98501	91,10	73,50	644161295869831
⑤	Z400025001		Asennussarja • Monteringssats • Mounting kit	33,90	27,30	644161295869211
⑥	Z97746001		Kiskosarja • Sats för skena • Rail kit 97301/98301, 97401/98401	22,10	17,85	644161295863031
	Z97747001		Kiskosarja • Sats för skena • Rail kit 97501/98501	26,00	21,00	644161295861741
⑦	Z97706001		Kiinnityshelat,V+O • Upphångningsbeslag i skåp,V+H • Suspension fittings, L+R	31,20	25,20	644161295857641
⑧	Z97703001		Helakisko 560 mm • Monteringsskena 560 mm • Mounting rail 560 mm	20,80	16,80	644161295860131

IDO SELECT Small, Medium, Large - Alakaappi, Underskåp, Base cabinet 97300/98300, 97400/98400, 97500/98500

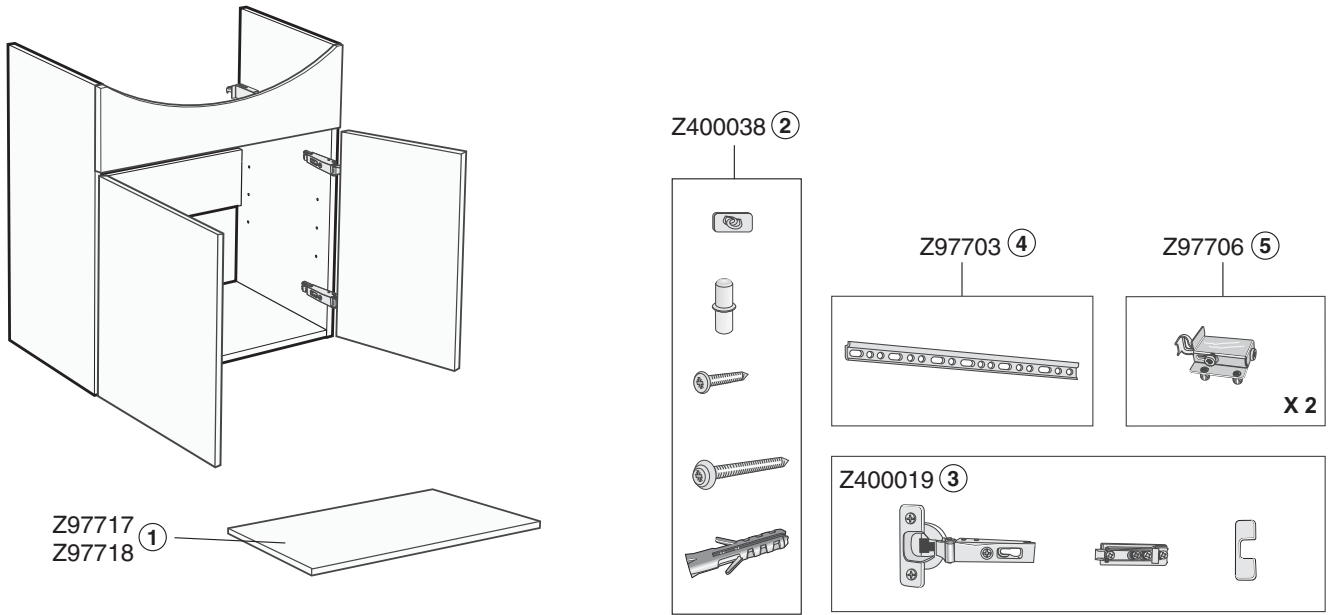

	Tuote Produkt Product	LVI- numero VVS- nummer	Nimike Benämning Item	Suositus- hinta Riktpris Price 24 % euro	Suositus- hinta Riktpris Price 0 % euro	EAN
①	Z97718001		Hylly 561x270 mm (97300/98300) • Hylly 561x270 mm (97300/98300) Shelf 561x270 mm (97300/98300)	24,70	19,95	
	Z97717001		Hylly 561x320 mm (97400/98400) • Hylly 561x320 mm (97400/98400) Shelf 561x320 mm (97400/98400)	24,70	19,95	
	Z97716001		Hylly 561x440 mm (97500/98500) • Hyllplan 561x440 mm (97500/98500) Shelf 561x440 mm (97500/98500)	24,70	19,95	
②	Z400038001		Asennussarja • Monteringsatts • Mounting kit	16,90	13,65	
③	Z400019001		Saranat • Gångjärn, komplett • Hinge, complete	32,60	26,25	
④	Z97703001		Helakisko 560 mm • Monteringsskena 560 mm • Mounting rail 560 mm	20,80	16,80	
⑤	Z97706001		Kiinnityshelat,V+O • Upphångningsbeslag i skåp,V+H • Suspension fittings, L+R	31,20	25,20	

IDO SELECT - Ovet, laatikonpää, etusovitteet • Dörrar, lådfronter, frontdelar • Doors, drawer ends, front adapter arch

Tuote Produkt Product	LVI- numero VVS- nummer	Nimike Benämning Item	Suositus- hinta Riktpris Price 24 % euro	Suositus- hinta Riktpris Price 0 % euro	EAN
Etusovite • Frontdel • Front adapter arch / Small 97303, 98303					
889x135 mm					
Z973312000I	6015019	Valkoinen, fasettahiottu • Vit fasett • White, faceted	73,16	59,00	64416129364208
Z973312100I	6015020	Valkoinen, sileä • Vit slät • White, smooth	73,16	59,00	64416129370162
Z973316200I	6015022	Tammiviilu • Ek slät • Oak veneer	104,16	84,00	64416129370179
Z973316300I	6015023	Pähkinäviilu • Valnöt slät • Walnut veneer	104,16	84,00	64416129371220
Z973316600I	6015024	Valkoinen korkeakiilto, sileä • Vit högblank slät • White, glossy, smooth	133,92	108,00	64416129370186
Z973317200I	6015025	Musta korkeakiilto, sileä • Svart högblank slät • Black, glossy, smooth	133,92	108,00	64416129370193
Z973317600I	6015026	Vaalea saarniviilu • Vit ask slät • White ash veneer	104,16	84,00	64416129370209
Z973317700I	6015027	Musta saarniviilu • Svart ask slät • Black ash veneer	104,16	84,00	64416129370216
Z973317800I	6015028	Tummanharmaa, sileä • Mörkgrå slät • Dark grey, smooth	73,16	59,00	64416129370223
Etusovite • Frontdel • Front adapter arch / Medium 97403, 98403					
889x165 mm					
Z974312000I	6015029	Valkoinen, fasettahiottu • Vit fasett • White, faceted	73,16	59,00	64416129370230
Z974312100I	6015030	Valkoinen, sileä • Vit slät • White, smooth	73,16	59,00	64416129370247
Z974316200I	6015032	Tammiviilu • Ek slät • Oak veneer	104,16	84,00	64416129370261
Z974316300I	6015033	Pähkinäviilu • Valnöt slät • Walnut veneer	104,16	84,00	64416129370278
Z974316600I	6015034	Valkoinen korkeakiilto, sileä • Vit högblank slät • White, glossy, smooth	133,92	108,00	64416129370285
Z974317200I	6015035	Musta korkeakiilto, sileä • Svart högblank slät • Black, glossy, smooth	133,92	108,00	64416129370292
Z974317600I	6015036	Vaalea saarniviilu • Vit ask slät • White ash veneer	104,16	84,00	64416129370308
Z974317700I	6015037	Musta saarniviilu • Svart ask slät • Black ash veneer	104,16	84,00	64416129370315
Z974317800I	6015038	Tummanharmaa, sileä • Mörkgrå slät • Dark grey, smooth	73,16	59,00	64416129370322
Etusovite • Frontdel • Front adapter arch / Large 97503, 98503					
889x135 mm					
Z975312000I	6015039	Valkoinen, fasettahiottu • Vit fasett • White, faceted	73,16	59,00	64416129370339
Z975312100I	6015040	Valkoinen, sileä • Vit slät • White, smooth	73,16	59,00	64416129370346
Z975316200I	6015042	Tammiviilu • Ek slät • Oak veneer	104,16	84,00	64416129370360
Z975316300I	6015043	Pähkinäviilu • Valnöt slät • Walnut veneer	104,16	84,00	64416129370377
Z975316600I	6015044	Valkoinen korkeakiilto, sileä • Vit högblank slät • White, glossy, smooth	133,92	108,00	64416129370384
Z975317200I	6015045	Musta korkeakiilto, sileä • Svart högblank slät • Black, glossy, smooth	133,92	108,00	64416129370391

IDO SELECT - Ovet, laatikonpäät, etusovitteet • Dörrar, lådfronter, frontdelar • Doors, drawer ends, front adapter arch

Tuote Produkt Product	LVI- numero VVS- nummer	Nimike Benämning Item	Suositus- hinta Riktpris Price 24 % euro	Suositus- hinta Riktpris Price 0 % euro	EAN
		Etusovite • Frontdel • Front adapter arch / Large 97503, 98503			
		889x135 mm			
Z975317600I	6015046	Vaalea saarniviilu • Vit ask slät • White ash veneer	104,16	84,00	64416129370407I
Z975317700I	6015047	Musta saarniviilu • Svart ask slät • Black ash veneer	104,16	84,00	64416129370414I
Z975317800I	6015048	Tummanharmaa, sileä • Mörkgrå slät • Dark grey, smooth	73,16	59,00	64416129370421I
		Etusovite • Frontdel • Front adapter arch			
		Large 97500, 97501, 98500, 98501 / 592x135 mm			
Z975302000I	6015061	Valkoinen, fasettahiottu • Vit fasett • White, faceted	60,76	49,00	64416129370551I
Z975302100I	6015062	Valkoinen, sileä • Vit slät • White, smooth	60,76	49,00	64416129370568I
Z975306200I	6015064	Tammiviilu • Ek slät • Oak veneer	111,60	90,00	64416129370582I
Z975306300I	6015065	Pähkinäviilu • Valnöt slät • Walnut veneer	111,60	90,00	64416129370599I
Z975306600I	6015066	Valkoinen korkeakiilto, sileä • Vit högblank slät • White, glossy, smooth	167,40	135,00	64416129370605I
Z975307200I	6015067	Musta korkeakiilto, sileä • Svart högblank slät • Black, glossy, smooth	167,40	135,00	64416129370612I
Z975307600I	6015068	Vaalea saarniviilu • Vit ask slät • White ash veneer	111,60	90,00	64416129370629I
Z975307700I	6015069	Musta saarniviilu • Svart ask slät • Black ash veneer	111,60	90,00	64416129370636I
Z975307800I	6015070	Tummanharmaa, sileä • Mörkgrå slät • Dark grey, smooth	60,76	49,00	64416129370643I
		Etusovite • Frontdel • Front adapter arch			
		Medium 97400, 97401, 98400, 98401 / 592x165 mm			
Z974302000I	6015071	Valkoinen, fasettahiottu • Vit fasett • White, faceted	60,76	49,00	64416129370650I
Z974302100I	6015072	Valkoinen, sileä • Vit slät • White, smooth	60,76	49,00	64416129370667I
Z974306200I	6015074	Tammiviilu • Ek slät • Oak veneer	111,60	90,00	64416129370681I
Z974306300I	6015075	Pähkinäviilu • Valnöt slät • Walnut veneer	111,60	90,00	64416129370698I
Z974306600I	6015076	Valkoinen korkeakiilto, sileä • Vit högblank slät • White, glossy, smooth	167,40	135,00	64416129370704I
Z974307200I	6015077	Musta korkeakiilto, sileä • Svart högblank slät • Black, glossy, smooth	167,40	135,00	64416129370711I
Z974307600I	6015078	Vaalea saarniviilu • Vit ask slät • White ash veneer	111,60	90,00	64416129370728I
Z974307700I	6015079	Musta saarniviilu • Svart ask slät • Black ash veneer	111,60	90,00	64416129370735I
Z974307800I	6015080	Tummanharmaa, sileä • Mörkgrå slät • Dark grey, smooth	60,76	49,00	64416129370742I

IDO SELECT - Ovet, laatikonpäät, etusovitteet • Dörrar, lådfronter, frontdelar • Doors, drawer ends, front adapter arch

Tuote Produkt Product	LVI- numero VVS- nummer	Nimike Benämning Item	Suositus- hinta Riktpris Price 24 % euro	Suositus- hinta Riktpris Price 0 % euro	EAN
		Etusovite • Frontdel • Front adapter arch			
		Small 97300, 97301, 98300, 98301 / 592x135 mm			
Z973302000I	6015081	Valkoinen, fasettahiottu • Vit fasett • White, faceted	60,76	49,00	6 4416129370759I
Z973302100I	6015082	Valkoinen, sileä • Vit slät • White, smooth	60,76	49,00	6 4416129370766I
Z973306200I	6015084	Tammiviilu • Ek slät • Oak veneer	111,60	90,00	6 4416129370780I
Z973306300I	6015085	Pähkinäviilu • Valnöt slät • Walnut veneer	111,60	90,00	6 4416129370797I
Z973306600I	6015086	Valkoinen korkeakiilto, sileä • Vit högblank slät • White, glossy, smooth	167,40	135,00	6 4416129370803I
Z973307200I	6015087	Musta korkeakiilto, sileä • Svart högblank slät • Black, glossy, smooth	167,40	135,00	6 4416129370810I
Z973307600I	6015088	Vaalea saarniviilu • Vit ask slät • White ash veneer	111,60	90,00	6 4416129370827I
Z973307700I	6015089	Musta saarniviilu • Svart ask slät • Black ash veneer	111,60	90,00	6 4416129370834I
Z973307800I	6015090	Tummanharmaa, sileä • Mörkgrå slät • Dark grey, smooth	60,76	49,00	6 4416129370841I
		Ovet • Dörrar • Doors / 97600, 97609, 98600, 98609			
		295x685 mm			
Z976202000I	6015091	Valkoinen, fasettahiottu • Vit fasett • White, faceted	89,28	72,00	6 4416129370858I
Z976202100I	6015092	Valkoinen, sileä • Vit slät • White, smooth	89,28	72,00	6 4416129370865I
Z976205900I	6015095	Alumiini/maitolasi, kehys • Aluminium/frostat glas • Aluminium/ Frosted glass, frame	205,84	166,00	6 4416129370896I
Z976206200I	6015096	Tammiviilu • Ek slät • Oak veneer	148,80	120,00	6 4416129370902I
Z976206300I	6015097	Pähkinäviilu • Valnöt slät • Walnut veneer	148,80	120,00	6 4416129370919I
Z976206600I	6015098	Valkoinen korkeakiilto, sileä • Vit högblank slät • White, glossy, smooth	130,20	105,00	6 4416129370926I
Z976207200I	6015099	Musta korkeakiilto, sileä • Svart högblank slät • Black, glossy, smooth	130,20	105,00	6 4416129370933I
Z976207300I	6015100	Alumiini/maitolasi, kehys Dandelion • Aluminium/frostat glas Dandelion. Aluminium/Frosted glass, frame Dandelion	205,84	166,00	6 4416129370940I
Z976207600I	6015101	Vaalea saarniviilu • Vit ask slät • White ash veneer	148,80	120,00	6 4416129370957I
Z976207700I	6015102	Musta saarniviilu • Svart ask slät • Black ash veneer	148,80	120,00	6 4416129370964I
Z976207800I	6015103	Tummanharmaa, sileä • Mörkgrå slät • Dark grey, smooth	85,56	69,00	6 4416129370971I
Z40018800I	6015134	Valkoinen, inline (vasemmalle ylös/alas oikealle) • Vit inline (vänster uppe/höger nere) • White, inline (LH Upper/RH Lower)	114,10	92,00	6 4416129371299I
Z40007300I		Valkoinen, inline (oikea ylös/alas vasemmalle) • Vit inline (höger uppe/vänster nere) • White, inline (RH Upper / LH Lower)	93,70	75,60	6 44161293590065I

IDO SELECT - Ovet, laatikonpää, etusovitteet • Dörrar, lådfronter, frontdelar • Doors, drawer ends, front adapter arch

Tuote Produkt Product	LVI- numero VVS- nummer	Nimike Benämning Item	Suositus- hinta Riktpris Price 24 % euro	Suositus- hinta Riktpris Price 0 % euro	EAN
		Ovet • Dörrar • Doors / 97300, -302, -400, -402, -500, -502, -604 & 98300, -302, -400, -402, -500, -502, -604 / 295x475 mm			
Z976202000	6015091	Valkoinen, fasettahiottu • Vit fasett • White, faceted	89,28	72,00	6416129370858
Z976212100	6015105	Valkoinen, sileä • Vit slät • White, smooth	81,84	66,00	6416129370995
Z976215900	6015108	Alumiini/maitolasi, kehys • Aluminium/frostat glas • Aluminium/ Frosted glass, frame	167,40	135,00	6416129371022
Z976216200	6015109	Tammiviilu • Ek slät • Oak veneer	122,76	99,00	6416129371039
Z976216300	6015110	Pähkinäviilu • Valnöt slät • Walnut veneer	122,76	99,00	6416129371046
Z976216600	6015111	Valkoinen korkeakiilto, sileä • Vit högblank slät • White, glossy, smooth	111,60	90,00	6416129371053
Z976217200	6015112	Musta korkeakiilto, sileä • Svart högblank slät • Black, glossy, smooth	111,60	90,00	6416129371060
Z976217300	6015113	Alumiini/maitolasi, kehys • Aluminium/frostat glas Aluminium/Frosted glass	167,40	135,00	6416129371077
Z976217600	6015114	Vaalea saarniviilu • Vit ask slät • White ash veneer	122,76	99,00	6416129371084
Z976217700	6015115	Musta saarniviilu • Svart ask slät • Black ash veneer	122,76	99,00	6416129371091
Z976217800	6015116	Tummanharmaa, sileä • Mörkgrå slät • Dark grey, smooth	81,84	66,00	6416129371107
Z400190001	6015136	Valkoinen, inline, vasen • Vit inline, vänster • White, inline, left	95,50	77,00	6416129371132
Z400076001		Valkoinen, inline, oikea • Vit inline, höger • White, inline, right	79,40	64,05	6416129370996
Z400302001	6015185	Valkoinen, inline, yläkaappi • Vit inline, överskåp • White in line, wall cabinet	78,10	63,00	6416129371763
		Laatikonpää • Lådfront • Drawer end - 97301, -401, -501; 98301, -401, -501 / 592x475 mm			
Z976222000		Valkoinen, fasettahiottu • Vit fasett • White, faceted	96,72	78,00	6416129371114
Z976222100	6015118	Valkoinen, sileä • Vit slät • White, smooth	96,72	78,00	6416129371121
Z976226200	6015121	Tammiviilu • Ek slät • Oak veneer	130,20	105,00	6416129371152
Z976226300	6015122	Pähkinäviilu • Valnöt slät • Walnut veneer	130,20	105,00	6416129371169
Z976226600	6015123	Valkoinen korkeakiilto, sileä • Vit högblank slät • White, glossy, smooth	137,64	111,00	6416129371176
Z976227200	6015124	Musta korkeakiilto, sileä • Svart högblank slät • Black, glossy, smooth	137,64	111,00	6416129371183
Z976227600	6015125	Vaalea saarniviilu • Vit ask slät • White ash veneer	130,20	105,00	6416129371190
Z976227700	6015126	Musta saarniviilu • Svart ask slät • Black ash veneer	130,20	105,00	6416129371206
Z976227800	6015127	Tummanharmaa, sileä • Mörkgrå slät • Dark grey, smooth	96,72	78,00	6416129371213
Z400192001	6015138	Valkoinen, inline • Vit inline • White, inline	121,50	98,00	6416129371336

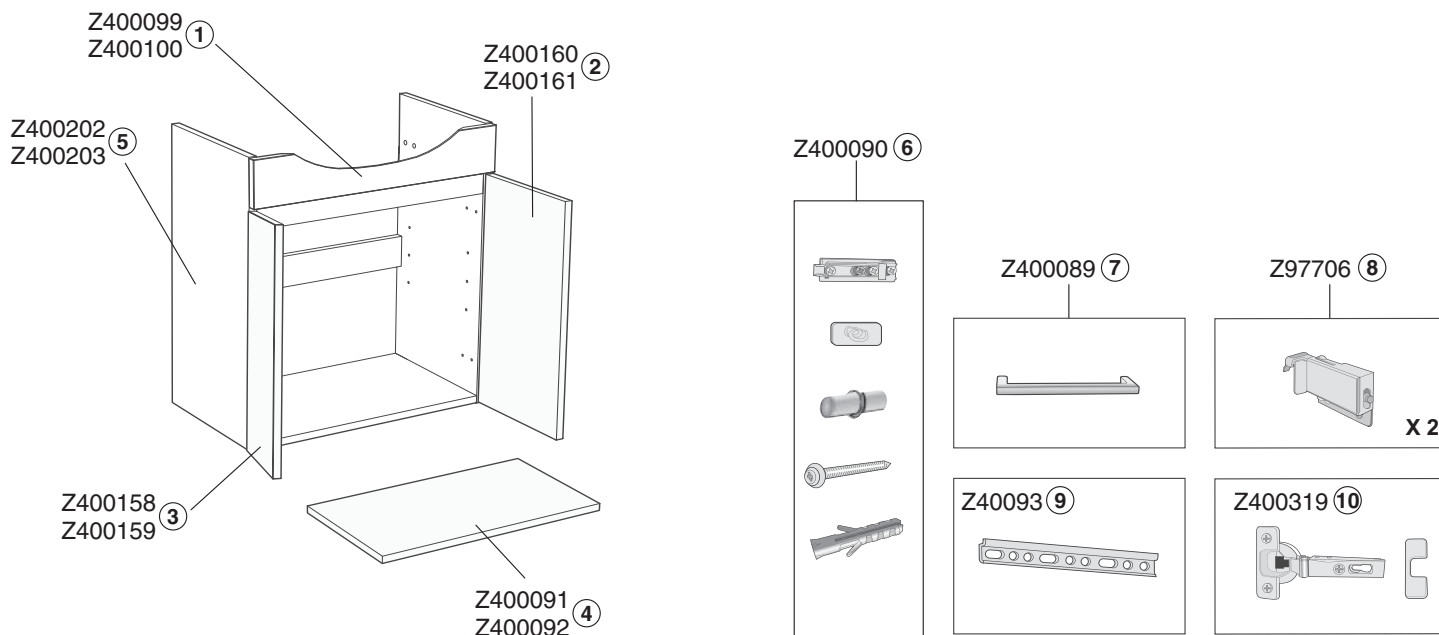



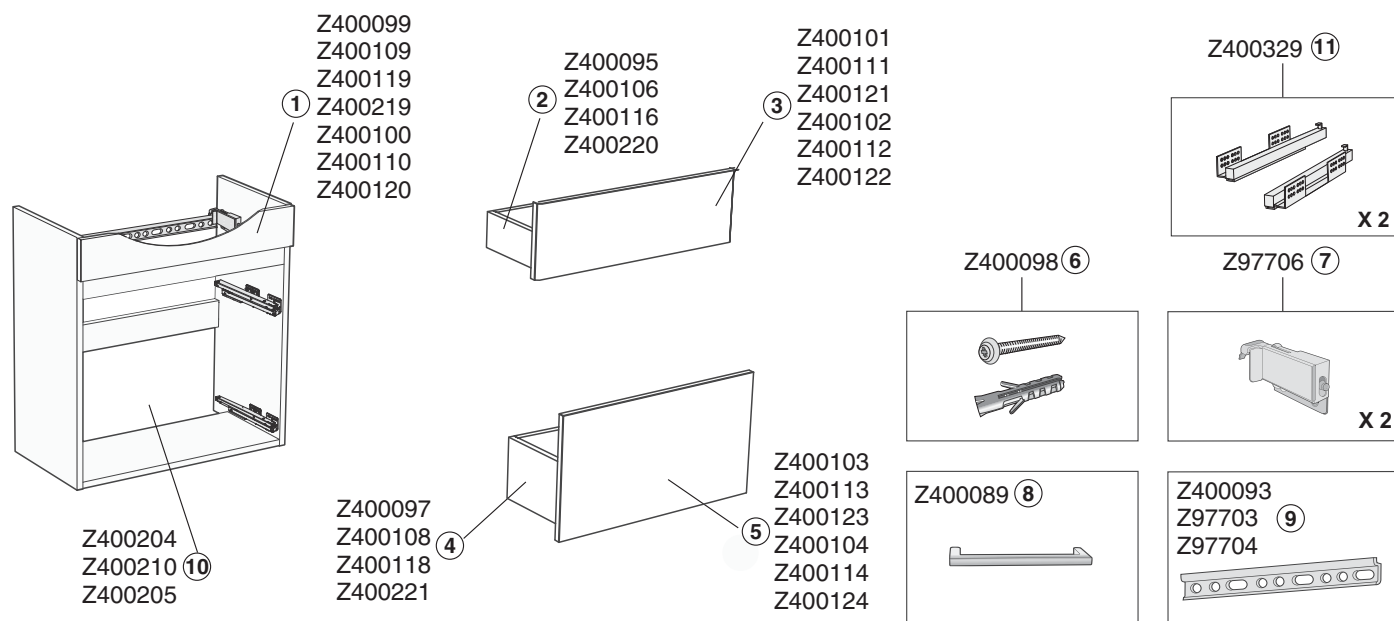

















IDO RENOVA Plus - Alakaappi, Underskåp, Base cabinet 9413 I

	Tuote Produkt Product	LVI- numero VVS- nummer	Nimike Benämning Item	Suositus- hinta Riktpris Price 24 % euro	Suositus- hinta Riktpris Price 0 % euro	EAN
①	Z400099001	6014806	Etusarja 560 mm, valkoinen • Frontdel 560 mm, vit • Front part 560 mm, white	48,20	38,85	
	Z400100001	6014807	Etusarja 560 mm, harmaa • Frontdel 560 mm, grå • Front part 560 mm, grey	48,20	38,85	
②	Z400160001	6014867	Ovi oikea, valkoinen • Dörr höger, vit • Door right, white	48,20	38,85	
	Z400161001	6014868	Ovi oikea, harmaa • Dörr höger, grå • Door right, grey	48,20	38,85	
③	Z400158001	6014865	Ovi vasen, valkoinen • Dörr vänster, vit • Door left, white	48,20	38,85	
	Z400159001	6014866	Ovi vasen, harmaa • Dörr vänster, grå • Door left, grey	48,20	38,85	
④	Z400091001	6014798	Hylly, valkoinen • Hylla, vit • Shelf, white	29,90	24,15	
	Z400092001	6014799	Hylly, harmaa • Hylla, grå • Shelf, grey	29,90	24,15	
⑤	Z400202001	6015148	Alakaappi, valkoinen • Underskåp, vit • Base cabinet, white	244,30	197,00	
	Z400203001	6015149	Alakaappi, harmaa • Underskåp, grå • Base cabinet, grey	262,90	212,00	
⑥	Z400090001	6014797	Asennussarja • Monteringssats • Mounting kit	29,90	24,15	
⑦	Z400089001	6014796	Vedin • Handtag • Handle	27,30	22,05	
⑧	Z97706001		Kiinnityshelat, V+O • Upphångningsbeslag i skåp, V+H • Suspension fittings, L+R	31,20	25,20	
⑨	Z400093001	6014800	Helakisko 500 mm • Monteringsskena 500 mm Mounting rail 500 mm	22,10	17,85	
⑩	Z400319001	6015180	Saranat • Gångjärn • Hinges	19,80	16,00	
	Z400057001	6582303	Vesilukko • Vattenlås • Water trap	40,40	32,55	

IDO RENOVA Plus - Alakaappi, Underskåp, Base cabinet 9433 I, 94299, 94399

	Tuote Produkt Product	LVI- numero VVS- nummer	Nimike Benämning Item	Suositus- hinta Riktpris Price 24 % euro	Suositus- hinta Riktpris Price 0 % euro	EAN
①	Z400099001	6014806	Etusarja 560 mm, valkoinen • Frontdel 560 mm, vit • Front part 560 mm, white	48,20	38,85	6441612915903241
	Z400109001	6014816	Etusarja 600 mm, valkoinen • Frontdel 600 mm vit • Front part 600 mm, white	48,20	38,85	6441612915904231
	Z400119001	6014826	Etusarja 900 mm, valkoinen • Frontdel 900 mm, vit • Front part 900 mm, white	57,30	46,20	6441612915905221
	Z400100001	6014807	Etusarja 560 mm, harmaa • Frontdel 560 mm, grå • Front part 560, grey	48,20	38,85	6441612915903311
	Z400110001	6014817	Etusarja 600 mm, harmaa • Frontdel 600 mm, grå • Front part 600 mm, grey	48,20	38,85	6441612915904301
	Z400120001	6014827	Etusarja 900 mm, harmaa • Frontdel 900 mm, grå • Front part 900 mm, grey	57,30	46,20	6441612915905391
②	Z400094001	6014801	Ylälaatikosto 560 mm, valkoinen • Övre låda 560 mm, vit Upper drawer 560 mm, white	57,30	46,20	6441612915902701
	Z400095001	6014802	Ylälaatikosto 560 mm, harmaa • Övre låda 560 mm, grå Upper drawer 560 mm, grey	57,30	46,20	6441612915902871
	Z400105001	6014812	Ylälaatikosto 600 mm, valkoinen • Övre låda 600 mm, vit Upper drawer 600 mm, white	57,30	46,20	6441612915903861
	Z400106001	6014813	Ylälaatikosto 600 mm, harmaa • Övre låda 600 mm, grå Upper drawer 600 mm, grey	57,30	46,20	6441612915903931
	Z400116001	6014823	Ylälaatikosto 900 mm, harmaa • Övre låda 900 mm, grå Upper drawer 900 mm, grey	71,60	57,75	6441612915904921
	Z400115001	6014822	Ylälaatikosto 900 mm, valkoinen • Övre låda 900 mm, vit Upper drawer 900 mm, white	71,60	57,75	6441612915904851
	③	Z400101001	6014808	Laatikonpää 533x187 mm, valkoinen • Lådfront 533x187 mm, vit Drawer end 533x187 mm, white	39,10	31,50
Z400111001		6014818	Laatikonpää 592x187 mm, valkoinen • Lådfront 592x187 mm, vit Drawer end 592x187 mm, white	39,10	31,50	6441612915904471
Z400121001		6014828	Laatikonpää 889x187 mm, valkoinen • Lådfront 889x187 mm, vit Drawer end 889x187 mm, white	39,10	31,50	6441612915905461
Z400102001		6014809	Laatikonpää 533x187 mm, harmaa • Lådfront 533x187 mm, grå Drawer end 533x187 mm, grey	39,10	31,50	6441612915903551
Z400112001		6014819	Laatikonpää 592x187 mm, harmaa • Lådfront 592x187 mm, grå Drawer end 592x187 mm, grey	39,10	31,50	6441612915904541

IDO RENOVA Plus - Alakaappi, Underskåp, Base cabinet 9433 I, 94299, 94399

	Tuote Produkt Product	LVI- numero VVS- nummer	Nimike Benämning Item	Suositus- hinta Riktpris Price 24 % euro	Suositus- hinta Riktpris Price 0 % euro	EAN	
③	Z40012200I	6014829	Laatikonpää 889x187 mm, harmaa • Lädfront 889x187 mm, grå Drawer end 889x187 mm, grey	39,10	31,50		
④	Z40009600I	6014803	Alalaatikosto 560 mm, valkoinen • Undre låda 560 mm, vit Bottom drawer 560 mm, white	66,40	53,55		
	Z40009700I	6014804	Alalaatikosto 560 mm, harmaa • Undre låda 560 mm, grå Bottom drawer 560 mm, grey	66,40	53,55		
	Z40010700I	6014814	Alalaatikosto 600 mm, valkoinen • Undre låda 600 mm, vit Bottom drawer 600 mm, white	66,40	53,55		
	Z40010800I	6014815	Alalaatikosto 600 mm, harmaa • Undre låda 600 mm, grå Bottom drawer 600 mm, grey	66,40	53,55		
	Z40011800I	6014825	Alalaatikosto 900 mm, harmaa • Undre låda 900 mm, grå Bottom drawer 900 mm, grey	80,70	65,10		
	Z40011700I	6014824	Alalaatikosto 900 mm, valkoinen • Undre låda 900 mm, vit Bottom drawer 900 mm, white	80,70	65,10		
	⑤	Z40010300I	6014810	Laatikonpää 533x322 mm, valkoinen • Lädfront 533x322 mm, vit Drawer end 533x322 mm, white	39,10	31,50	
		Z40011300I	6014820	Laatikonpää 592x322 mm, valkoinen • Lädfront 592x322 mm, vit Drawer end 592x322 mm, white	39,10	31,50	
Z40012300I		6014830	Laatikonpää 889x322 mm, valkoinen • Lädfront 889x322 mm, vit Drawer end 889x322 mm, white	39,10	31,50		
Z40010400I		6014811	Laatikonpää 533x322 mm, harmaa • Lädfront 533x322 mm, grå Drawer end 533x322 mm, grey	39,10	31,50		
Z40011400I		6014821	Laatikonpää 592x322 mm, harmaa • Lädfront 592x322 mm, grå Drawer end 592x322 mm, grey	39,10	31,50		
Z40012400I		6014831	Laatikonpää 889x322 mm, harmaa • Lädfront 889x322 mm, grå Drawer end 889x322 mm, grey	39,10	31,50		
⑥		Z40009800I	6014805	Asennussarja • Monteringsatts • Mounting kit	29,90	24,15	
⑦	Z9770600I		Kiinnityshelat, V+O • Upphångningsbeslag i skåp, V+H • Suspension fittings, L+R	31,20	25,20		
⑧	Z40008900I	6014796	Vedin • Handtag • Handle	27,30	22,05		
⑨	Z40009300I	6014800	Helakisko 500 mm • Monteringskena 500 mm • Mounting rail 500 mm	22,10	17,85		
	Z9770300I		Helakisko 560 mm • Monteringskena 560 mm • Mounting rail 560 mm	20,80	16,80		
	Z9770400I		Helakisko 855 mm • Monteringskena 855 mm • Mounting rail 855 mm	35,20	28,35		
⑩	Z40020400I	6015150	Alakaapin runko, valkoinen • Underskåp stomme, vit Base cabinet, white	370,80	299,00		
	Z40020500I	6015151	Alakaapin runko, harmaa • Underskåp stomme, grå Base cabinet, grey	393,10	317,00		
⑪	Z40032900I	6014928	Alalaatikon kiskot, V+O • Utdragsskenor låda, V+H • Rails drawers, L+R	47,10	38,00		
	Z9779400I		Vesilukko • Vattenlös • Water trap	41,70	33,60		

IDO RENOVA Plus -Yläkaappi, Överskåp, Upper cabinet 94709

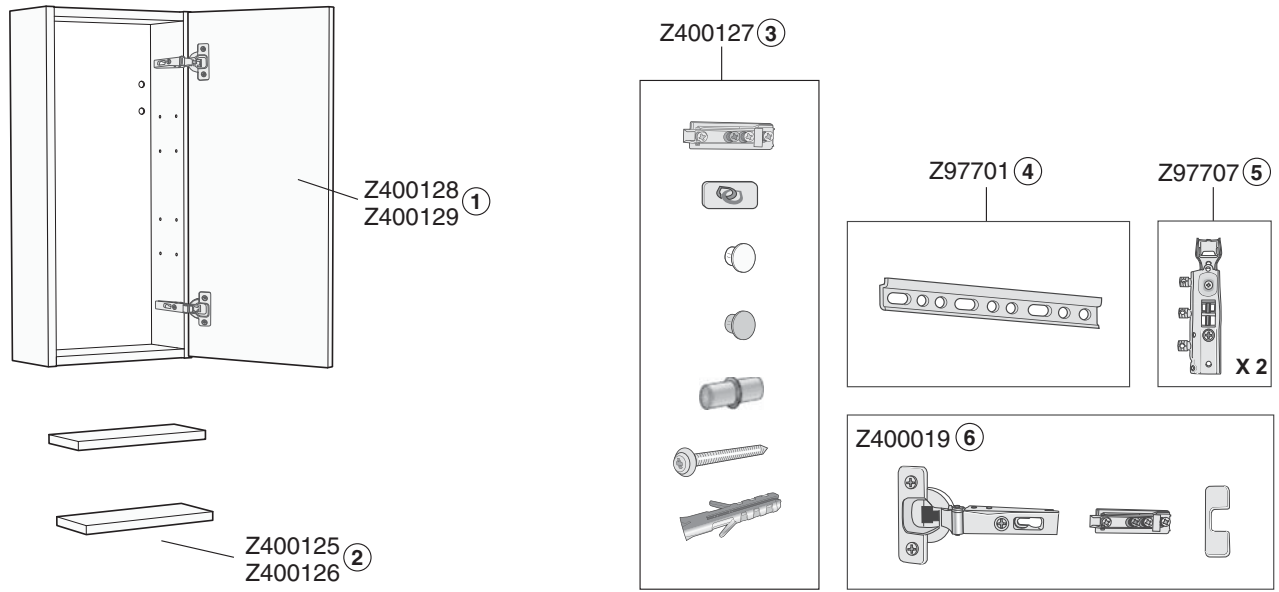

	Tuote Produkt Product	LVI- numero VVS- nummer	Nimike Benämning Item	Suositus- hinta Riktpris Price 24 % euro	Suositus- hinta Riktpris Price 0 % euro	EAN
①	Z40012800I	6014835	Ovi, valkoinen 295x635 mm • Dörr, vit 295x635 mm • Door, white 295x635 mm	48,20	38,85	6441612945906144
	Z40012900I	6014836	Ovi, harmaa 295x635 mm • Dörr, grå 295x635 mm • Door, grey 295x635 mm	48,20	38,85	6441612945906211
②	Z40012500I	6014832	Hylly, valkoinen • Hylla, vit • Shelf, white	22,10	17,85	6441612945905844
	Z40012600I	6014833	Hylly, harmaa • Hylla, grå • Shelf, grey	22,10	17,85	6441612945905911
③	Z40012700I	6014834	Asennussarja • Monteringssats • Mounting kit	22,10	17,85	6441612945906071
④	Z9770100I		Helakisko 260 mm • Monteringskena 260 mm • Mounting rail 260 mm	26,00	21,00	6441612945857571
⑤	Z9770700I		Kiinnityshelat, V+O • Upphångningsbeslag i skåp, V+H • Suspension fittings, L+R	19,50	15,75	6441612945854671
⑥	Z40001900I		Saranat • Gångjärn, komplett • Hinges complete	32,60	26,25	6441612945863101

IDO RENOVA Plus - Korkeakaappi, Högskåp, High cabinet 94700

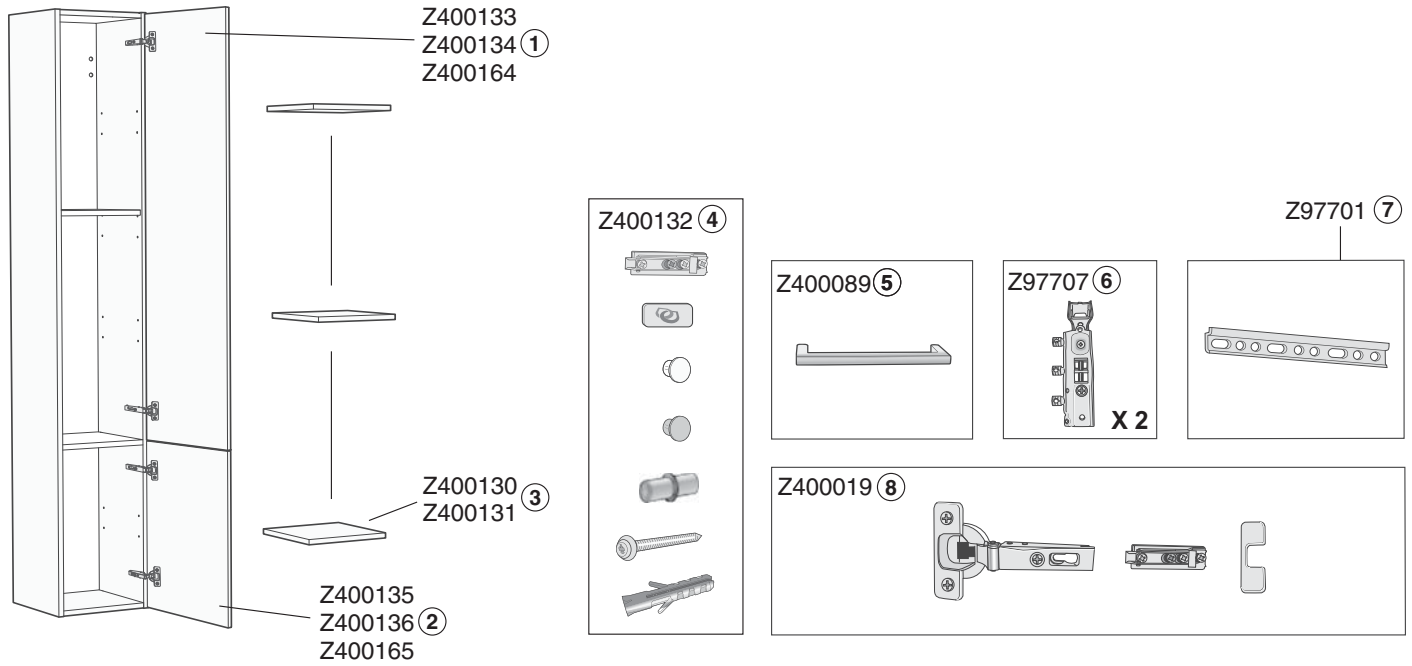

	Tuote Produkt Product	LVI- numero VVS- nummer	Nimike Benämning Item	Suositus- hinta Riktpris Price 24 % euro	Suositus- hinta Riktpris Price 0 % euro	EAN
①	Z40013300I	6014840	Ovi 295x1309 mm, valkoinen • Dörr 295x1309 mm, vit Door 295x1309 mm, white	29,90	24,15	6441612945906694
	Z40013400I	6014841	Ovi 295x1309 mm, harmaa • Dörr 295x1309 mm, grå Door 295x1309 mm, grey	29,90	24,15	6441612945906764
②	Z40013500I	6014842	Ovi 295x512 mm, valkoinen • Dörr 295x512 mm, vit Door 295x512 mm, white	29,90	24,15	6441612945906834
	Z40013600I	6014843	Ovi 295x512 mm, harmaa • Dörr 295x512 mm, grå • Door 295x512 mm, grey	29,90	24,15	6441612945906904
③	Z40013000I	6014837	Hylly, valkoinen • Hylla, vit • Shelf, white	32,60	26,25	6441612945906384
	Z40013100I	6014838	Hylly, harmaa • Hylla, grå • Shelf, grey	32,60	26,25	6441612945906454
④	Z40013200I	6014839	Asennussarja • Monteringssats • Mounting kit	32,60	26,25	6441612945906524
⑤	Z40008900I	6014796	Vedin c/c 128 mm • Handtag c/c 128 mm • Handle c/c 128 mm	27,30	22,05	6441612945902254
⑥	Z9770700I		Kiinnityshelat, V+O • Upphängningsbeslag i skåp, V+H • Suspension fittings, L+R	19,50	15,75	6441612945854674
⑦	Z9770100I		Helakisko 260 mm • Monteringsskena 260 mm • Mounting rail 260 mm	26,00	21,00	6441612945857574
⑧	Z40001900I		Saranat • Gångjärn, komplett • Hinges complete	32,60	26,25	6441612945863104

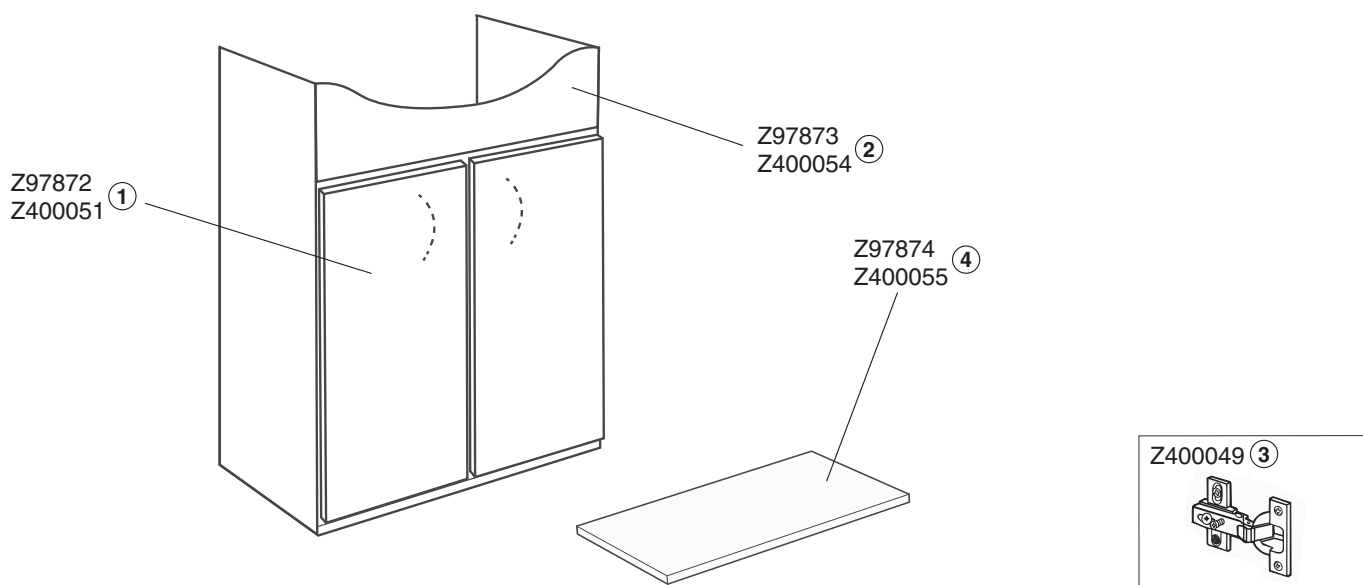
IDO RENOVA - Alakaappi, Underskåp, Base cabinet 93131

	Tuote Produkt Product	LVI- numero VVS- nummer	Nimike Benämning Item	Suositus- hinta Riktpris Price 24 % euro	Suositus- hinta Riktpris Price 0 % euro	EAN
1	Z97872001		Ovi, valkoinen • Dörr, vit • Door, white	44,30	35,70	
	Z400051001		Ovi, tammi • Dörr, ek • Door, oak	52,10	42,00	
2	Z97873001		Etusarja, valkoinen • Frontdel, vit • Front part, white	37,80	30,45	
	Z400054001		Etusarja, tammi • Frontdel, ek • Front part, oak	35,20	28,35	
3	Z400049001		Saranat • Gångjärn • Hinges	44,30	35,70	
4	Z97874001		Hylly, valkoinen • Hyllplan, vit • Shelf, white	24,70	19,95	
	Z400055001		Hylly, tammi • Hyllplan, ek • Shelf, oak	22,10	17,85	
	Z400050001		Asennus-sarja • Monteringsatts • Mounting kit	33,90	27,30	
	Z400057001	6582303	Vesilukko • Vattenlås • Water trap	40,40	32,55	
	Z400201001	6015147	Alakaappi, tammi • Underskåp, ek • Base cabinet, oak	262,90	212,00	
	Z400200001	6015146	Alakaappi, valkoinen • Underskåp, vit • Base cabinet, white	244,30	197,00	

IDO Smart - Alakaappi, Underskåp, Base cabinet 96340

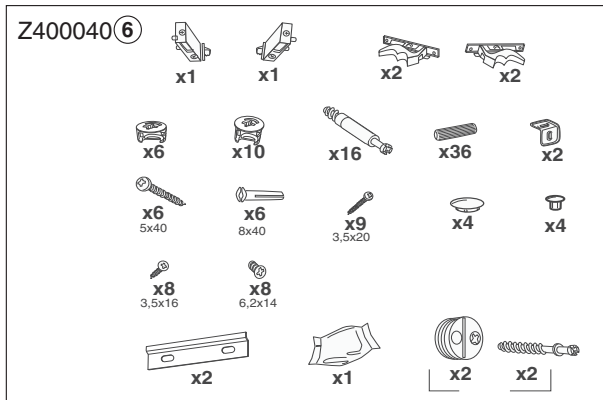
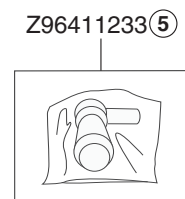
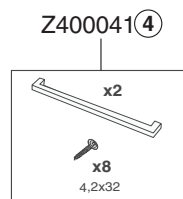
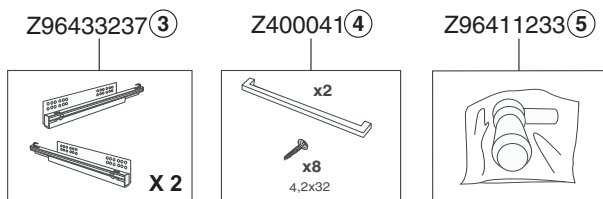
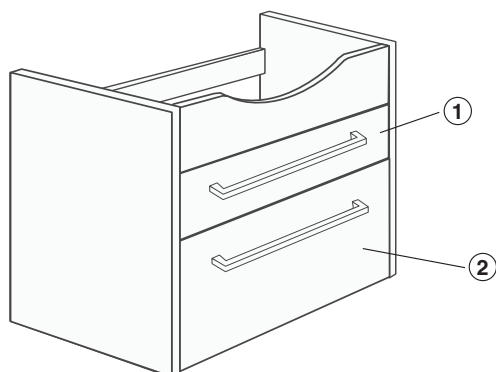

	Tuote Produkt Product	LVI- numero VVS- nummer	Nimike Benämning Item	Suositus- hinta Riktpris Price 24 % euro	Suositus- hinta Riktpris Price 0 % euro	EAN
①			Tuote- ja hintatiedot asiakaspalvelustamme • Information och pris vid förfrågan For product information and price contact our customer service			
②			Tuote- ja hintatiedot asiakaspalvelustamme • Information och pris vid förfrågan For product information and price contact our customer service			
③	Z96433237001		Liukukisko, V+O • Utdragsskena, V+H • Railgrass, L+R	80,70	65,10	
④	Z400041001		Vedin, täydellinen • Handtag komplett • Cabinet grip complete	15,60	12,60	
⑤	Z96411233001		Vesilukko • Vatenlås • Water trap	35,20	28,35	
⑥	Z400040001		Asennussarja • Monteringsatts • Mounting kit	46,90	37,80	

IDO Smart - Alakaappi, Underskåp, Base cabinet 96360

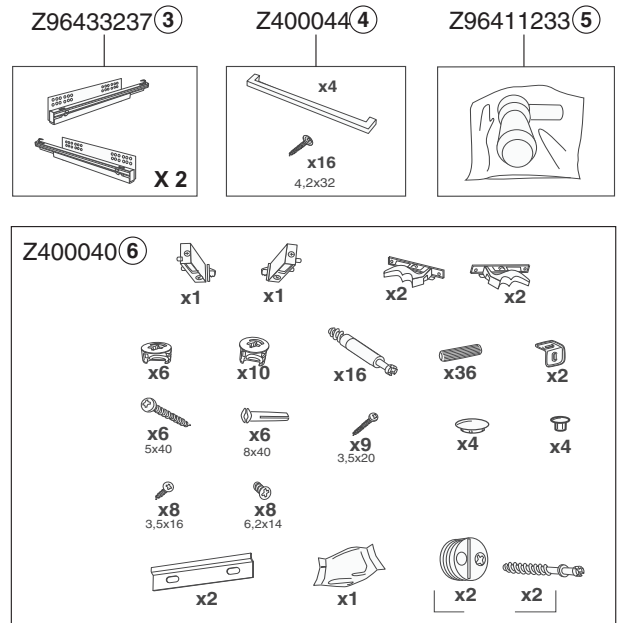
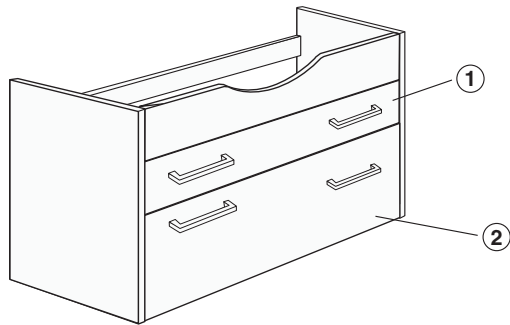

	Tuote Produkt Product	LVI- numero VVS- nummer	Nimike Benämning Item	Suositus- hinta Riktpris Price 24 % euro	Suositus- hinta Riktpris Price 0 % euro	EAN
①			Tuote- ja hintatiedot asiakaspalvelustamme • Information och pris vid förfrågan For product information and price contact our customer service			
②			Tuote- ja hintatiedot asiakaspalvelustamme • Information och pris vid förfrågan For product information and price contact our customer service			
③	Z96433237001		Liukukisko,V+O • Utdragsskena,V+H • Railgrass, L+R	80,70	65,10	6 44 1 61 2 9 4 5 8 7 5 4 6 1
④	Z400044001		Vedin, täydellinen • Handtag, komplett • Cabinet grip, complete	14,30	11,55	6 44 1 61 2 9 4 5 8 7 5 9 1 1
⑤	Z96411233001		Vesilukko • Vatenlös • Water trap	35,20	28,35	6 44 1 61 2 9 4 5 8 7 5 3 9 1
⑥	Z400040001		Asennussarja • Monteringssats • Mounting kit	46,90	37,80	6 44 1 61 2 9 4 5 3 6 2 1 1

IDO Smart - Korkeakaappi, Högskap, High cabinet 963 I I

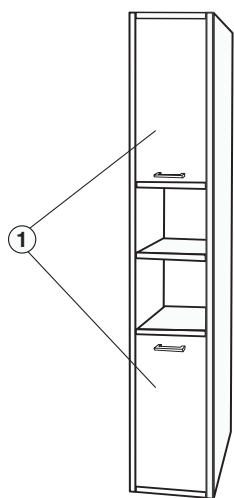

Z400042 ②

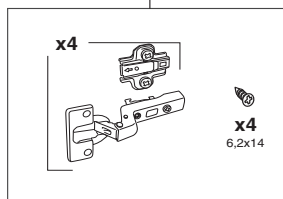

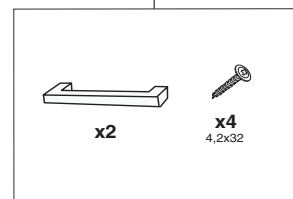

Z400044 ③

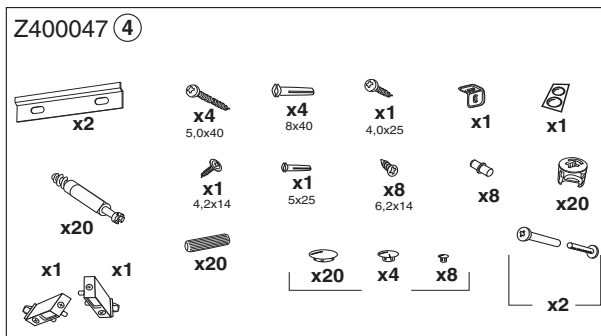

Z400047 ④

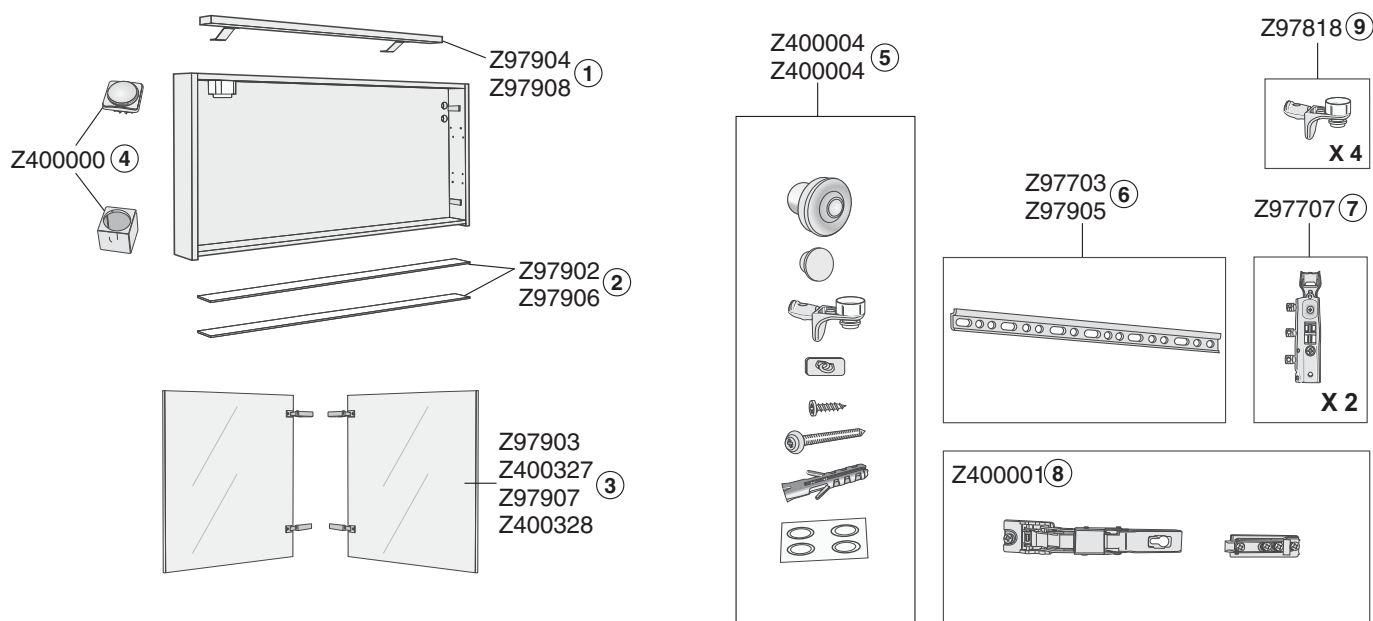

	Tuote Produkt Product	LVI- numero VVS- nummer	Nimike Benämning Item	Suositus- hinta Riktpris Price 24 % euro	Suositus- hinta Riktpris Price 0 % euro	EAN
①			Tuote- ja hintatiedot asiakaspalvelustamme • Information och pris vid förfrågan For product information and price contact our customer service			
②	Z40004200I		Saranat, täydellinen • Gångjärn, komplett • Hinges, complete	14,30	11,55	
③	Z40004400I		Vedin, täydellinen • Handtag, komplett • Cabinet grip, complete	14,30	11,55	
⑥	Z40004700I		Asennussarja • Monteringsatts • Mounting kit	59,90	48,30	

IDO Reflect -peilikaappi, spegelskåp, mirror cabinet 98934, 98935 (IDO Trend)

	Tuote Produkt Product	LVI- numero VVS- nummer	Nimike Benämning Item	Suositus- hinta Riktpris Price 24 % euro	Suositus- hinta Riktpris Price 0 % euro	EAN
①	Z97904001		Loisteputkilamppu 600 mm • Lysrörsarmatur 600 mm Fluorescent lamp 600 mm complete (98934)	169,30	136,50	64416129586389
	Z97908001		Loisteputkilamppu 900 mm • Lysrörsarmatur 900 mm Fluorescent lamp 900 mm complete (98935)	205,70	165,90	64416129586426
②	Z97902001		Lasihylly 567x80 mm • Glashylla 567x80 mm Glass shelf 567x80 mm (98934)	40,40	32,55	64416129586365
	Z97906001		Lasihylly 867x80 mm • Glashylla 867x80 mm Glass shelf 867x80 (98935)	43,00	34,65	64416129586402
③	Z97903001		Peiliovi 296x540 mm, vasen (98934) • Spegeldörr 296x540 mm, vänster (98934) Mirror door 296x540 mm, left (98934)	87,20	70,35	64416129586372
	Z400327001	6014936	Peiliovi 296x540 mm, oikea (98934) • Spegeldörr 296x540 mm, höger (98934) Mirror door 296x540 mm, right (98934)	121,50	98,00	64416129586409
	Z97907001		Peiliovi, vasen 446x540 mm (98935) • Spegeldörr, vänster 446x540 mm (98935) Mirror door, left 446x540 mm (98935)	97,70	78,75	64416129586419
	Z400328001	6014937	Peiliovi, oikea (98935) 446x540 mm • Spegeldörr, höger 446x540 mm (98935) Mirror door, right 446x540 mm (98935)	132,70	107,00	64416129586484
④	Z400000001		Sähköpistoke, täydellinen • Eluttag komplett • Electrical outlet complete	97,70	78,75	64416129585474
⑤	Z400004001		Asennussarja (98934) • Monteringsatts (98934) • Mounting kit (98934)	59,90	48,30	64416129585380
	Z400005001		Asennussarja (98935) • Monteringsatts (98935) • Mounting kit (98935)	100,30	80,85	64416129585397
⑥	Z97703001		Helakisko 560 mm • Monteringsskena 560 mm • Mounting rail 560 mm	20,80	16,80	64416129586013
	Z97905001		Helakisko 860 mm • Monteringsskena 860 mm • Mounting rail 860 mm	29,90	24,15	64416129586396
⑦	Z97707001		Kiinnityshelat, V+O • Upphångningsbeslag i skåp, V+H • Suspension fittings, L+R	19,50	15,75	64416129585467
⑧	Z400001001		Saranat, täydellinen • Gångjärn, komplett • Hinges complete	31,20	25,20	64416129585481
⑨	Z97818001		Lasihyllytuki • Glashyllbärare • Glass shelf support	6,50	5,25	64416129586334

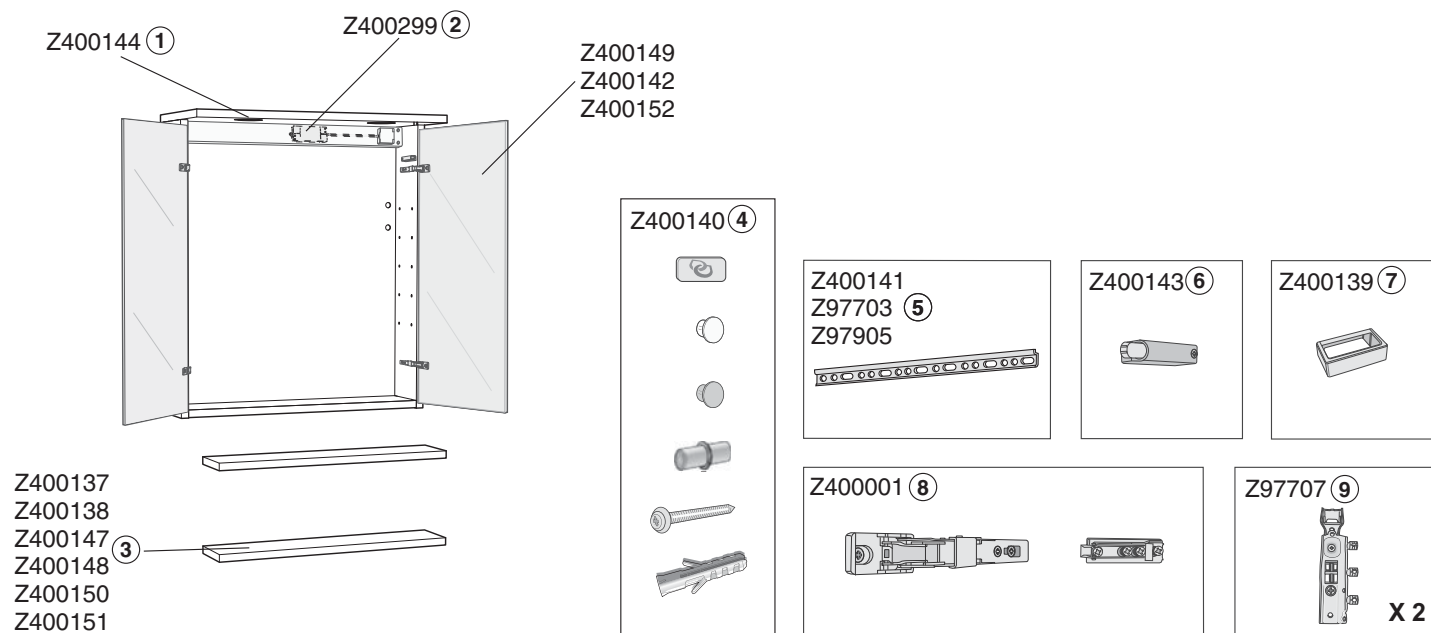
IDO Reflect Spot -peilikaappi, spegelskåp, mirror cabinet 94428, 94728, 94429, 94729, 94430, 94730 (IDO Renova Plus)

	Tuote Produkt Product	LVI- numero VVS- nummer	Nimike Benämning Item	Suositus- hinta Riktpris Price 24 % euro	Suositus- hinta Riktpris Price 0 % euro	EAN
①	Z400144001	6014851	LED-valot • Led belysning • Led lightning	57,30	46,20	6441612945907751
②	Z400299001	6014941	Muuntaja LED + sähköpistoke • Transformator LED + eluttag Transformer LED +power outlet	132,68	107,00	6441612942409911
③	Z400137001	6014844	Hylly 525 mm, valkoinen • Hylla 525 mm, vit • Shelf 525 mm, white	32,60	26,25	6441612945907061
	Z400138001	6014845	Hylly 525 mm, harmaa • Hylla 525 mm, grå • Shelf 525 mm, grey	32,60	26,25	6441612945907131
	Z400147001	6014854	Hylly 565 mm, valkoinen • Hylla 565 mm, vit • Shelf 565 mm, white	32,60	26,25	6441612945908051
	Z400148001	6014855	Hylly 565 mm, harmaa • Hylla 565 mm, grå • Shelf 565 mm, grey	32,60	26,25	6441612945908121
	Z400150001	6014857	Hylly 865 mm, valkoinen • Hylla 865 mm, vit • Shelf 865 mm, white	43,00	34,65	6441612945908336
	Z400151001	6014858	Hylly 865 mm, harmaa • Hylla 865 mm, grå • Shelf 865 mm, grey	43,00	34,65	6441612945908431
④	Z400140001	6014847	Asennussarja • Monteringssats • Mounting kit	20,80	16,80	6441612945907371
⑤	Z400141001	6014848	Helakisko 525 mm • Monteringsskena 525 mm Mounting rail 525 mm	15,60	12,60	6441612945907441
	Z97703001		Helakisko 560 mm • Monteringsskena 560 mm Mounting rail 560 mm	20,80	16,80	6441612945860131
	Z97905001		Helakisko 860 mm • Monteringsskena 860 mm Mounting rail 860 mm	29,90	24,15	6441612945863961
⑥	Z400143001	6014850	Peilioven vaimennin • Dämpning spegeldörr Damper mirror door	15,60	12,60	6441612945907681
⑦	Z400139001	6014846	Vedin • Handtag • Handle	20,80	16,80	6441612945907201
⑧	Z400001001		Saranat täydellinen • Gångjärn, komplett • Hinges complete	31,20	25,20	6441612945854811
⑨	Z97707001		Kiinnityshelat, V+O • Upphångningsbeslag i skåp, V+H • Suspension fittings, L+R	19,50	15,75	6441612945854671

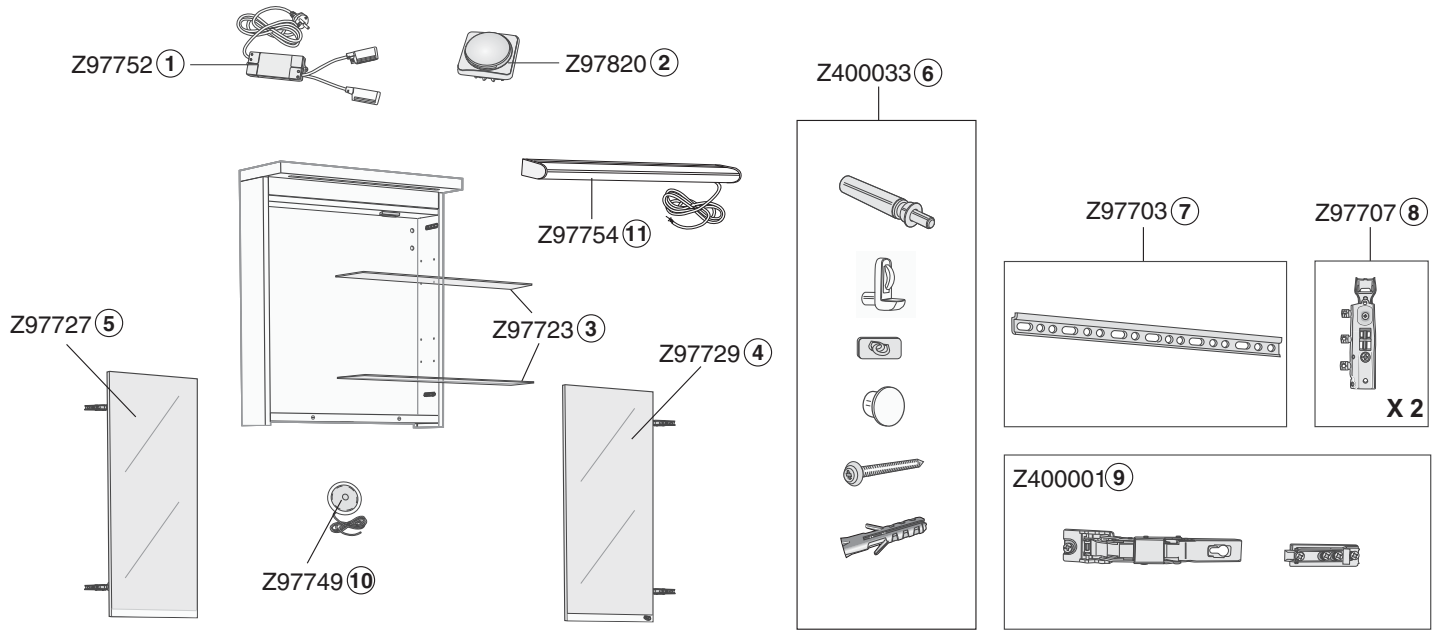
IDO Reflect LED -peilikaappi, spegelskåp, mirror cabinet 97615 (IDO Select)

	Tuote Produkt Product	LVI- numero VVS- nummer	Nimike Benämning Item	Suositus- hinta Riktpris Price 24 % euro	Suositus- hinta Riktpris Price 0 % euro	EAN
①	Z97752001		Muuntaja • Transformator • Transformer	92,40	74,55	644161295871954
②	Z97820001		Sähköpistoke täydellinen • Eluttag, komplett • Electrical outlet, complete	52,10	42,00	644161295871574
③	Z97723001		Lasihylly 555x100 mm • Glashylla 555x100 mm • Glass shelf 555x100 mm	40,40	32,55	644161295872874
④	Z97729001		Peiliovi 295x660 mm (oikea) • Spegeldörr 295x660 mm (höger) Mirror door 295x660 mm (right)	89,80	72,45	644161295873934
⑤	Z97727001		Peiliovi 295x660 mm (vasen) • Spegeldörr 295x660 mm (vänster) Mirror door 295x660 mm (left)	89,80	72,45	644161295873864
⑥	Z400033001		Asennussarja • Monteringsssats • Mounting kit	45,60	36,75	644161295874614
⑦	Z97703001		Helakisko 560 mm • Monteringskena 560 mm • Mounting rail 560 mm	20,80	16,80	644161295860134
⑧	Z97707001		Kiinnityshelat, V+O • Upphångningsbeslag i skåp, V+H • Suspension fittings, L+R	19,50	15,75	644161295854674
⑨	Z400001001		Saranat, täydellinen • Gångjärn, komplett • Hinge, complete	31,20	25,20	644161295854814
⑩	Z97749001		LED-valaisin • LED-lampa • LED lamp	92,40	74,55	644161295874094
	Z97758001		Pleksilasi 558x75 mm • Plexiglas 558x75 mm • Plexiglass 558x75 mm	45,60	36,75	644161295874234
	Z97761001		Hyllynkannatin liukuhyllyyn • Hyllbärare för låda med eluttag Shelf support for sliding shelf	6,50	5,25	644161295871404
⑪	Z97754001		Loisteputkilamppu T5 21W • Lysrörsbelysning T5 21W Fluorescent lamp T5 21W	92,40	74,55	644161295874094

Reflect LED -peilikaappi, spegelskåp, mirror cabinet 97616 (IDO Select)

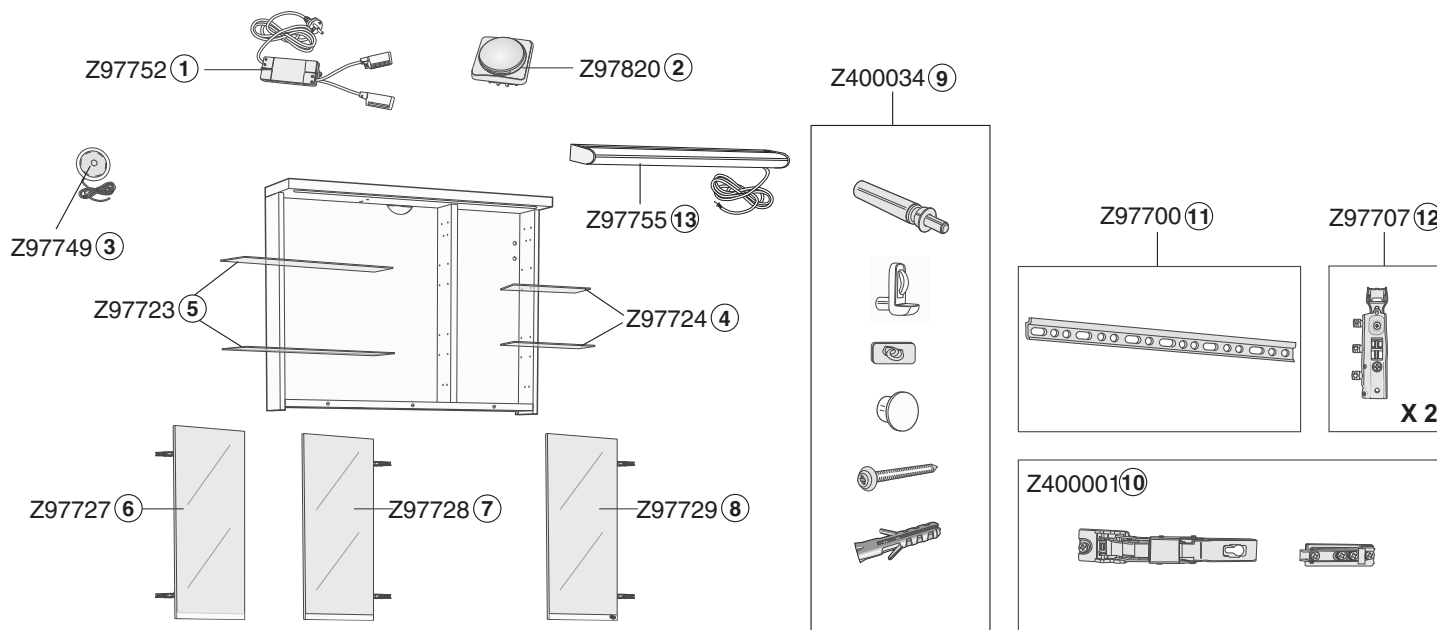

	Tuote Produkt Product	LVI- numero VVS- nummer	Nimike Benämning Item	Suositus- hinta Riktpris Price 24 % euro	Suositus- hinta Riktpris Price 0 % euro	EAN
①	Z97752001		Muuntaja • Transformator • Transformer LED	92,40	74,55	6441612945871954
②	Z97820001		Sähköpistoke täydellinen • Eluttag, komplett • Electrical outlet, complete	52,10	42,00	6441612945871574
③	Z97749001		LED-valaisin • LED-lampa • LED lamp	92,40	74,55	6441612945874094
④	Z97724001		Lasihylly 268x100 mm • Glashylla 268x100 mm • Glass shelf 268x100 mm	29,90	24,15	6441612945873314
⑤	Z97723001		Lasihylly 555x100 mm • Glashylla 555x100 mm • Glass shelf 555x100 mm	40,40	32,55	6441612945872874
⑥	Z97727001		Peiliovi 295x660 mm (vasen) • Spegeldörr 295x660 mm (vänster) Mirror door 295x660 mm (left)	89,80	72,45	6441612945873864
⑦	Z97728001		Peiliovi 295x660 mm (oikea) • Spegeldörr 295x660 mm (höger) Mirror door 295x660 mm (right)	92,40	74,55	6441612945874304
⑧	Z97729001		Peiliovi 295x660 mm (oikea) • Spegeldörr 295x660 mm (höger) Mirror door 295x660 mm (right)	89,80	72,45	6441612945873934
⑨	Z400034001		Asennussarja • Monteringssats • Mounting kit	84,60	68,25	6441612945874784
⑩	Z400001001		Saranat täydellinen • Gångjärn, komplett • Hinge, complete	31,20	25,20	6441612945854814
⑪	Z97704001		Helakisko 885 mm • Monteringsskena 885 mm • Mounting rail 885 mm	35,20	28,35	6441612945873244
⑫	Z97707001		Kiinnityshelat, V+O • Upphångningsbeslag i skåp, V+H • Suspension fittings, L+R	19,50	15,75	6441612945854674
⑬	Z97755001		Loisteputkilamppu T5 21W • Lysrörsbelysning T5 21W Fluorescent lamp T5 21W	109,40	88,20	6441612945874474
	Z97759001		Pleksilasi 883x75 mm • Plexiglas 883x75 mm • Plexiglass 883x75 mm	63,80	51,45	6441612945874544

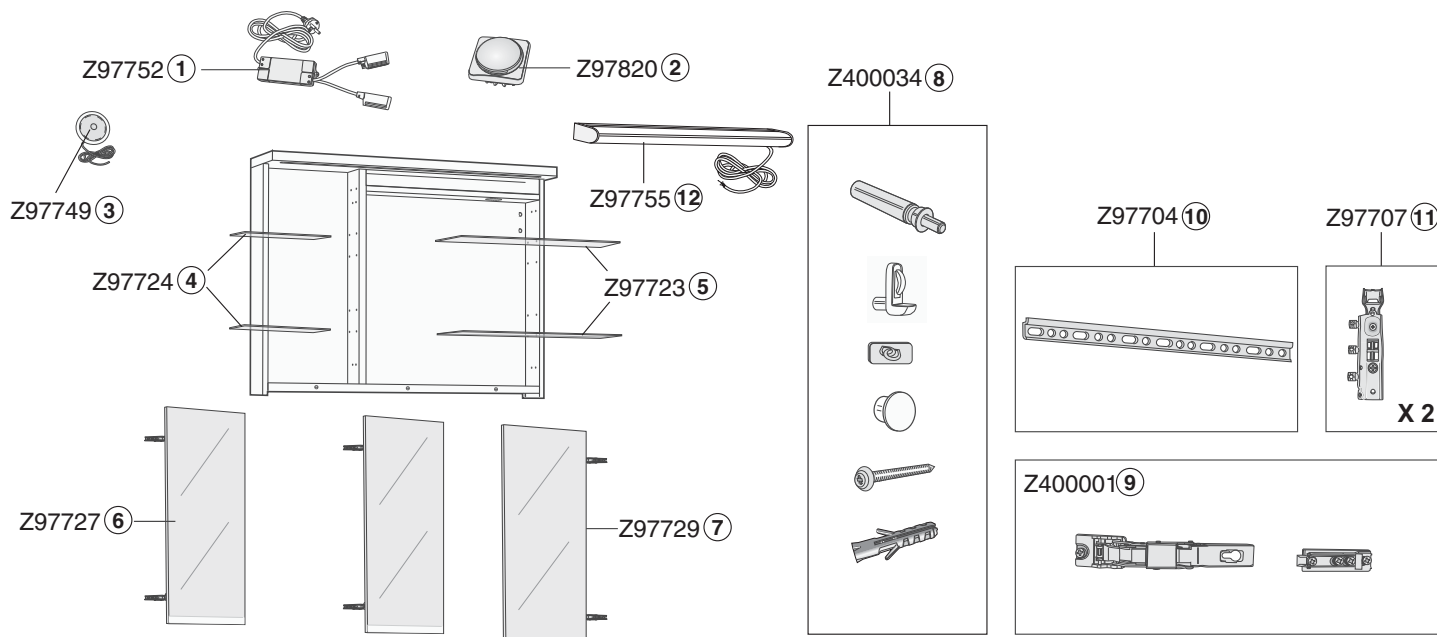
IDO Reflect LED -peilikaappi, spegelskåp, mirror cabinet 97617 (IDO Select)

	Tuote Produkt Product	LVI- numero VVS- nummer	Nimike Benämning Item	Suositus- hinta Riktpris Price 24 % euro	Suositus- hinta Riktpris Price 0 % euro	EAN
①	Z97752001		Muuntaja • Transformator • Transformer LED	92,40	74,55	6441612945871954
②	Z97820001		Sähköpistoke täydellinen • Eluttag, komplett • Electrical outlet, complete	52,10	42,00	6441612945871574
③	Z97749001		LED-valaisin • LED-lampa • LED lamp	92,40	74,55	6441612945874094
④	Z97724001		Lasihylly 268x100 mm • Glashylla 268x100 mm • Glass shelf 268x100 mm	29,90	24,15	6441612945873314
⑤	Z97723001		Lasihylly 555x100 mm • Glashylla 555x100 mm • Glass shelf 555x100 mm	40,40	32,55	6441612945872874
⑥	Z97727001		Peiliovi 295x660 mm (vasen) • Spegeldörr 295x660 mm (vänster) Mirror door 295x660 mm (left)	89,80	72,45	6441612945873864
⑦	Z97729001		Peiliovi 295x660 mm (oikea) • Spegeldörr 295x660 mm (höger) Mirror door 295x660 mm (right)	89,80	72,45	6441612945873934
⑧	Z400034001		Asennussarja • Monteringssats • Mounting kit	84,60	68,25	6441612945874784
⑨	Z400001001		Saranat täydellinen • Gångjärn, komplett • Hinge, complete	31,20	25,20	6441612945854814
⑩	Z97704001		Helakisko 885 mm • Monteringsskena 885 mm • Mounting rail 885 mm	35,20	28,35	6441612945873244
⑪	Z97707001		Kiinnityshelat, V+O • Upphångningsbeslag i skåp, V+H • Suspension fittings, L+R	19,50	15,75	6441612945854674
⑫	Z97755001		Loisteputkilamppu T5 21W • Lysrörsbelysning T5 21W Fluorescent lamp T5 21W	109,40	88,20	6441612945874474
	Z97759001		Pleksilasi 883x75 mm • Plexiglas 883x75 mm • Plexiglass 883x75 mm	63,80	51,45	6441612945874544
	Z97761001		Hyllynkannatin liukuhyllyyn • Hyllbärare för låda med eluttag Shelf support for sliding shelf	6,50	5,25	6441612945871404

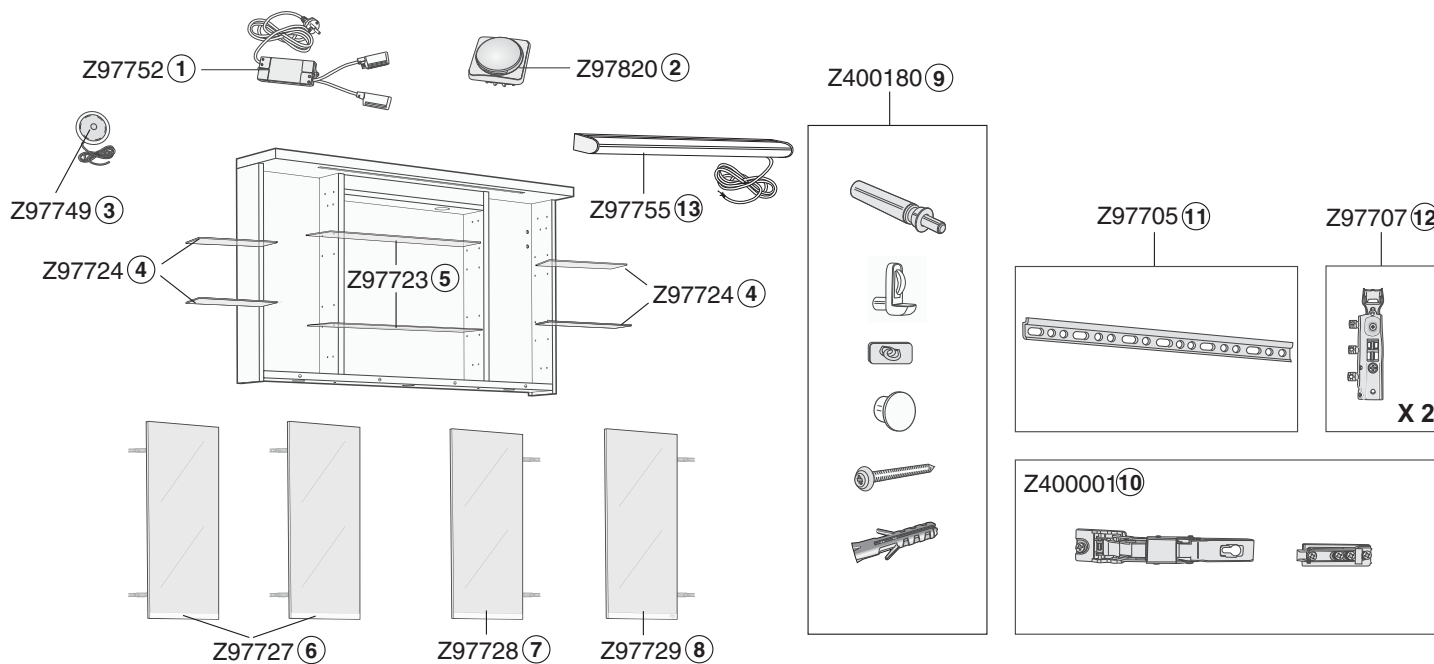
IDO Reflect LED -peilikaappi, spegelskåp, mirror cabinet 97618 (IDO Select)

	Tuote Produkt Product	LVI- numero VVS- nummer	Nimike Benämning Item	Suositus- hinta Riktpris Price 24 % euro	Suositus- hinta Riktpris Price 0 % euro	EAN
①	Z97752001		Muuntaja • Transformator • Transformer LED	92,40	74,55	
②	Z97820001		Sähköpistoke täydellinen • Eluttag, komplett • Electrical outlet, complete	52,10	42,00	
③	Z97749001		LED-valaisin • LED-lampa • LED lamp	92,40	74,55	
④	Z97724001		Lasihylly 268x100 mm • Glashylla 268x100 mm • Glass shelf 268x100 mm	29,90	24,15	
⑤	Z97723001		Lasihylly 555x100 mm • Glashylla 555x100 mm • Glass shelf 555x100 mm	40,40	32,55	
⑥	Z97727001		Peiliovi 295x660 mm (vasen) • Spegeldörr 295x660 mm (vänster) Mirror door 295x660 mm (left)	89,80	72,45	
⑦	Z97728001		Peiliovi 295x660 mm (oikea) • Spegeldörr 295x660 mm (höger) Mirror door 295x660 mm (right)	92,40	74,55	
⑧	Z97729001		Peiliovi 295x660 mm (oikea) • Spegeldörr 295x660 mm (höger) Mirror door 295x660 mm (right)	89,80	72,45	
⑨	Z400180001	6014883	Asennussarja • Monteringssats • Mounting kit	49,50	39,90	
⑩	Z400001001		Saranat täydellinen • Gångjärn, komplett • Hinge, complete	31,20	25,20	
⑪	Z97705001		Helakisko 1150 mm • Monteringsskena 1150 mm • Mounting rail 1150 mm	41,70	33,60	
⑫	Z97707001		Kiinnityshelat, V+O • Upphångningsbeslag i skåp, V+H • Suspension fittings, L+R	19,50	15,75	
⑬	Z97755001		Loisteputkilamppu T5 21W • Lysrörsbelysning T5 21W Fluorescent lamp T5 21W	109,40	88,20	
	Z97759001		Pleksilasi 883x75 mm • Plexiglas 883x75 mm • Plexiglass 883x75 mm	63,80	51,45	
	Z97761001		Hyllynkannatin liukuhyllyyn • Hyllbärare för låda med eluttag Shelf support for sliding shelf	6,50	5,25	

