

ILLUXTRON® FLUXE 75/90 HV-400/600 LM

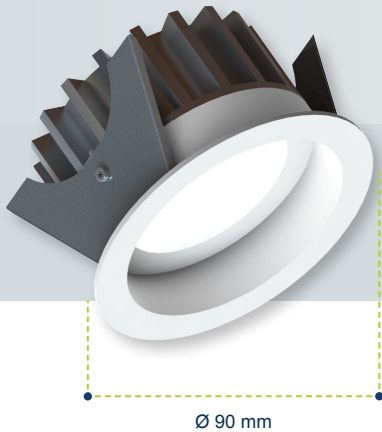

Ø 90 mm

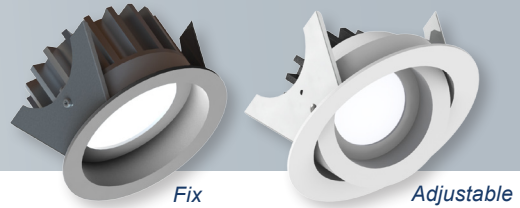

Fix

Adjustable

Specifications

	FLUXE 75 HV fix	FLUXE 90 HV adj.
Color (XX) (choose white or grey)	MW = Matt white ral 9016 / GR = Matt grey ral 9006	
Input voltage	220-240V~ 50/60 Hz	
Lumen output	400 Lm / 600 Lm	
Color Rendering Index (CRI)	82	
Beam angle	Fix = 60°	Adj. 400Lm = 24° / 600Lm = 60°
Material	Diecast aluminum	
Environment	Indoor, outdoor and cove lighting	
Protection against water	IP20/IP44	
Protection against shock	IK02	
Powerfactor (P _f)	400 Lm = 0,91 / 600 Lm = 0,98	
Dimmable	Yes, see dimmer compatibility at page 18	
Operating temperature	-20°C / +45°C	
Safety norms	EN60598 / EN62031 / EN62471	
EMC norms	EN55015	
Quantity single package	1 pc	
Weight single package	Fix = 260 gr	Adj. = 283 gr
Dimensions single package	105x105x61 mm	105x105x105 mm
Quantity per carton	42 pcs	35 pcs
Dimensions carton	400x300x380 mm (0.046 m ³)	600x400x400 mm (0.096m ³)
Quantity per pallet	1344 pcs	560 pcs
Expected lifetime at 25°C (L70)	400 Lm = 49.000 hrs / 600 Lm = 50.000 hrs	
Warranty	3 years	

All values are measured at 230V (+/- 7%)

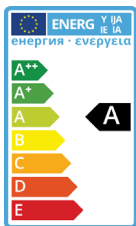

Product variations

Description	Article no.	W	Efficacy
DIMMABLE			
Fluxe 75 HV-400 Lm 3000K Fix 60°	807003XX4902	9W	45 Lm/W
Fluxe 90 HV-400 Lm 3000K Adj. 24°	808403XX4902	9W	45 Lm/W
Fluxe 75 HV-600 Lm 2700K Fix 60°	807603XX4802	11W	55 Lm/W
Fluxe 75 HV-600 Lm 3000K Fix 60°	807603XX4902	11W	55 Lm/W
Fluxe 75 HV-600 Lm 4000K Fix 60°	807603XX5002	11W	55 Lm/W
Fluxe 90 HV-600 Lm 2700K Adj. 60°	808603XX4802	11W	55 Lm/W
Fluxe 90 HV-600 Lm 3000K Adj. 60°	808603XX4902	11W	55 Lm/W
Fluxe 90 HV-600 Lm 4000K Adj. 60°	808603XX5002	11W	55 Lm/W

All values are measured at 230V (+/- 7%)

Measurements

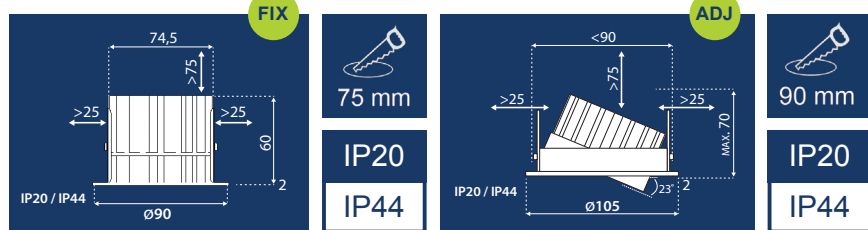

IP20/IP44: Only when the luminaire is installed in a closed ceiling it can be exposed to splashing water from the front side.

Photometrics

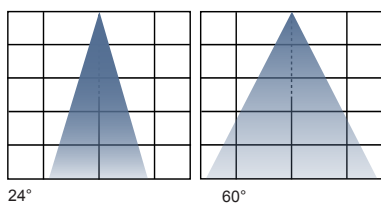

Expected lifetime data

Test information	T _J 220V	Expected Lifetime	T _J 230V	Expected Lifetime	T _J 240V	Expected Lifetime
Test data from LED supplier	33°C	50.000 Hrs	33°C	50.000 Hrs	33°C	50.000 Hrs
Test data from LED supplier	83°C	50.000 Hrs	83°C	50.000 Hrs	83°C	50.000 Hrs
Test data from LED supplier	93°C	42.000 Hrs	93°C	42.000 Hrs	93°C	42.000 Hrs
Fluxe 75 HV-400 Lm	81°C	50.000 Hrs	85°C	49.000 Hrs	89°C	45.000 Hrs
Fluxe 75 HV-600 Lm	75°C	50.000 Hrs	77°C	50.000 Hrs	79°C	50.000 Hrs

• Lifetime date is tested in a closed ceiling without insulation material covering the downlight housing
• Expected lifetime measured at Ta 25°C (L70)

PLUG & PLAY INSTALLATION

HV - HIGH VOLTAGE

HV Busbar

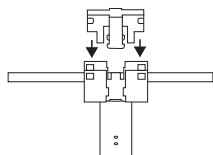

The HV Busbar is a customer friendly product that will give you an easy installation.
Just place the cable in the busbar holder and push the cap on!

Plug & Play

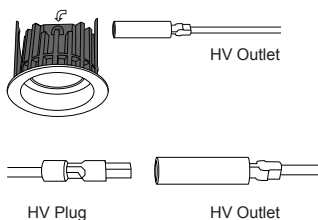

Connectionbox

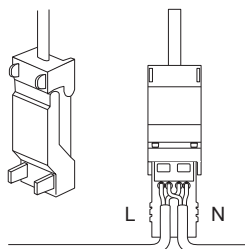

The Connection box is equipped with push-in contacts for a quick and easy installation. Also the wire grip is screwless by pressing the top cover downwards.

Solution 01: 230V Line installation (Busbar)		Suspended ceiling
<p>① 2.0 m</p>	<p>① 0.5 m</p>	<p>① 0.5 m</p>
<p>HV Outlet to Europlug Art.no.: 595205BL0000</p>	<p>HV Outlet to GST18 3P male Art.no.: 605205BL0000</p>	<p>HV Outlet to Connection box Art.no.: 615205BL0000</p>
<p>② 3.0 m</p>	<p>③</p>	<p>⑮</p>
<p>HV Plug to Outlet (extension) Art.no.: 545205BL1500</p>	<p>HV Busbar Art.no.: 009105BL0000</p>	<p>HV Dimming cable 0.2 m* Art.no.: 585205BL0000</p>

* Only one dimming cable per dimming circuit (any spot is ok)

Solution 02: 230V Star installation (6 Way distributor box)		Suspended ceiling
<p>④ 1.8 m</p>	<p>④ 1.0 m</p>	<p>④ 1.0 m</p>
<p>6 Way Distributor to Europlug Art.no.: 599305BL0000</p>	<p>6 Way Distributor to GST18 3P male Art.no.: 609305BL0000</p>	<p>6 Way Distributor to Connection box Art.no.: 619305BL0000</p>
<p>② 3.0 m</p>	<p>②</p>	
<p>HV Plug to Outlet (extension) Art.no.: 545205BL1500</p>	<p>HV GST18 3P female socket Art.no.: P03-201048BL</p>	

Solution 03: 230V Line installation (Connection box)		Concrete ceiling
<p>⑤ 0.2 m</p>		
<p>HV Busbar to Connection box Art.no.: 575205BL0000</p>		

220-240V Line installation (Busbar)

Suspended ceiling

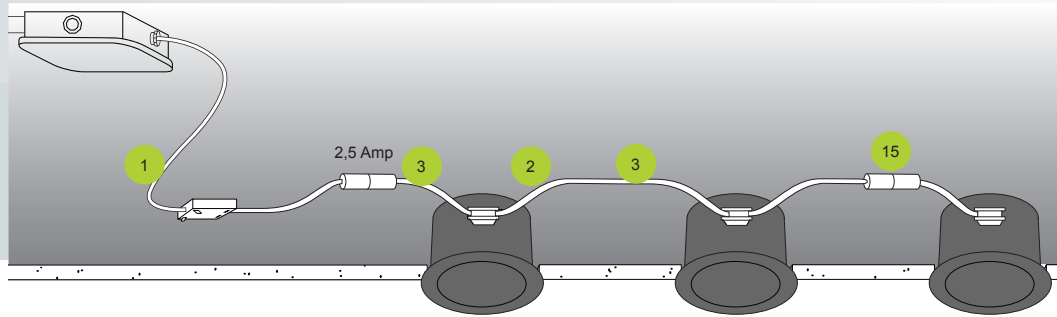

Article number	595205BL0000	605205BL0000	615205BL0000
Description	HV Outlet to Europlug 2.0 m	HV Outlet to GST18 3P male 0,5 m	HV Outlet to Connection box 0,5 m
Protection against water	IP20	IP20	IP20
Voltage	220-240V~	220-240V~	220-240V~
Warranty	3 years	3 years	3 years
Safety norms	EN60320	EN60320	EN60320
Quantity single package	1 pc	1 pc	1 pc
Weight single package	92 gr	38 gr	48 gr
Package type	Plastic bag	Plastic bag	Plastic bag
Quantity per carton	160 pcs	160 pcs	160 pcs
Dimensions carton	400x300x380 mm (0.046 m³)	400x300x380 mm (0.046 m³)	400x300x380 mm (0.046 m³)
Quantity per pallet	5120 pcs	5120 pcs	5120 pcs

All values are measured at 230V (+/- 7%)



HV Busbar

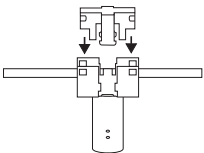

The HV Busbar is a customer friendly product that will give you an easy installation.

Just place the cable in the busbar holder and push the cap on!

Article number	545205BL1500	009105BL0000	585205BL0000
Description	HV Plug to Outlet 3,0 m	HV Busbar	HV Dimming cable 0,2 m
Protection against water	IP20	IP20	IP20
Voltage	220-240V~	220-240V~	220-240V~
Warranty	3 years	3 years	3 years
Safety norms	EN60320	EN60320	EN60320
Quantity single package	1 pc	10 pcs	1 pc
Weight single package	106 gr	30 gr	20 gr
Package type	Plastic bag	Plastic bag	Plastic bag
Quantity per carton	120 pcs	3.200 pcs	160 pcs
Dimensions carton	400x300x380 mm (0.046 m³)	400x300x380 mm (0.046 m³)	400x300x380 mm (0.046 m³)
Quantity per pallet	3840 pcs	102.400 pcs	5120 pcs



All values are measured at 230V (+/- 7%)

PLUG & PLAY HV SOLUTION 02

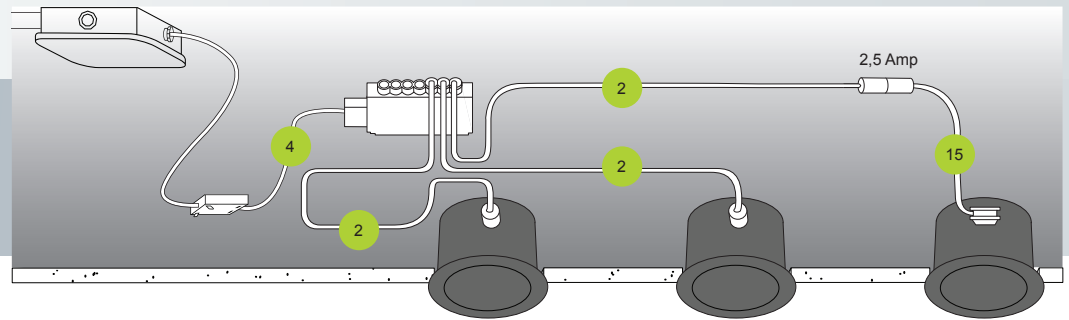

220-240V Star installation (6 Way distributor box)

Suspended ceiling

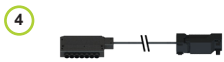

			
Article number	599305BL0000	609305BL0000	619305BL0000
Description	6 Way Distributor to Europlug 1,8 m	6 Way Distrib. to GST18 3P male 1,0 m	6 Way Distributor to Conn. box 1,0 m
Protection against water	IP20	IP20	IP20
Voltage	220-240V~	220-240V~	220-240V~
Warranty	3 years	3 years	3 years
Safety norms	EN60320	EN60320	EN60320
Quantity single package	1 pc	1 pc	1 pc
Weight single package	108 gr	76 gr	88 gr
Package type	Plastic bag	Plastic bag	Plastic bag
Quantity per carton	120 pcs	120 pcs	120 pcs
Dimensions carton	400x300x380 mm (0.046 m ³)	400x300x380 mm (0.046 m ³)	400x300x380 mm (0.046 m ³)
Quantity per pallet	3840 pcs	3840 pcs	3840 pcs

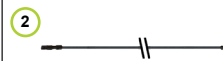
All values are measured at 230V (+/- 7%)

			
Article number	545205BL1500	585205BL0000	
Description	HV Plug to Outlet 3,0 m	HV Dimming cable 0,2 m	
Protection against water	IP20	IP20	
Voltage	220-240V~	220-240V~	
Warranty	3 years	3 years	
Safety norms	EN60320	EN60320	
Quantity single package	1 pc	1 pc	
Weight single package	106 gr	20 gr	
Package type	Plastic bag	Plastic bag	
Quantity per carton	120 pcs	160 pcs	
Dimensions carton	400x300x380 mm (0.046 m ³)	400x300x380 mm (0.046 m ³)	
Quantity per pallet	3840 pcs	5120 pcs	

All values are measured at 230V (+/- 7%)

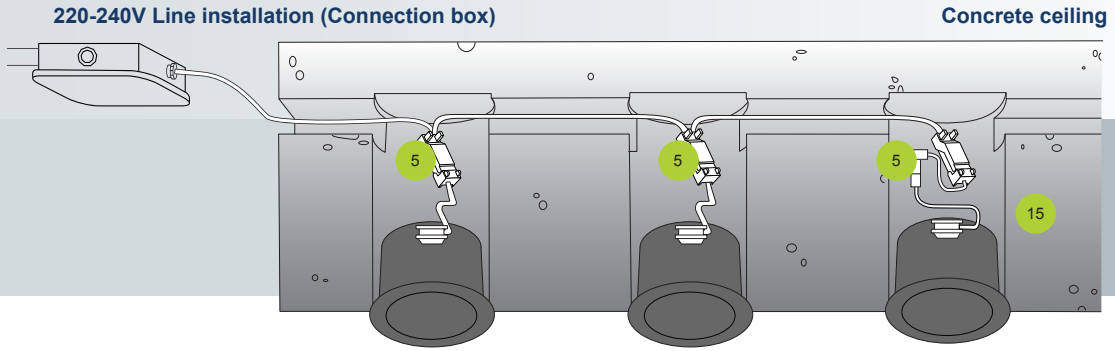

	5	15	
Article number	575205BL0000	585205BL0000	
Description	HV Busbar to Connection box 0,2 m	HV Dimming cable 0,2 m	
Protection against water	IP20	IP20	
Voltage	220-240V~	220-240V~	
Warranty	3 years	3 years	
Safety norms	EN60320	EN60320	
Quantity single package	1 pc	1 pc	
Weight single package	38 gr	20 gr	
Package type	Plastic bag	Plastic bag	
Quantity per carton	160 pcs	160 pcs	
Dimensions carton	400x300x380 mm (0.046 m³)	400x300x380 mm (0.046 m³)	
Quantity per pallet	5120 pcs	5120 pcs	

All values are measured at 230V (+/- 7%)



Manufacturer	Model	Type	Load	HV-75/90 400 Lm	HV-75/90 400 Lm + Dimming cable	HV-75/90 600 Lm HV-185 1250/2000 Lm
Berker	2830 10	R	60-400 W	✗	✓ 10-100%	✓ 20-100%
Berker	2867 10	RC	20-360 W	✗	✓ 10-100%	✓ 40-100%
Berker	2873	RL	20-500 W	✗ 40-90%	✓ 0-100%	✓ 20-100%
Busch Jaeger	6523U	RL	2-100 W	✓ 10-100%	✓ 0-100%	✓ 0-100%
Busch Jaeger	2247U	RL	20-250 W	✓ 20-100%	✓ 0-100%	✓ 0-100%
Elimpo	ECODIM9XX	-	3-80 W	✓ 0-100%	✓ 0-100%	✓ 0-100%
Eltako	EUD61NPN-UC	RLC	0-400 W	✓ 0-100%	✓ 0-100%	✓ 20-100%
Feller	40600.RL	RL	40-600 W	✗ 20-80%	✓ 0-100%	✓ 20-100%
Feller	40300.RC	RC	20-300 W	✓ 10-100%	✗	✓ 40-100%
Feller	40420.RLC	RLC	40-420 W	✗	✗	✗
Gira	1184-00	R	60-400 W	✗	✓ 10-100%	✓ 20-100%
Gira	1182-00	RC	20-360 W	✗	✓ 10-100%	✓ 40-100%
Gira	2262-00	RL	20-500 W	✗ 40-90%	✓ 0-100%	✓ 20-100%
Jung	244 EX	R	60-400 W	✗	✓ 10-100%	✓ 20-100%
Jung	243 EX	RC	20-360 W	✗	✓ 10-100%	✓ 40-100%
Jung	225 NV DE	RL	20-500 W	✗ 40-90%	✓ 0-100%	✓ 20-100%
Legrand	078406	RLC	8-300 W	✓ 10-100%	✓ 10-100%	✓ 10-100%
Legrand	067085	RLC	8-300 W	✓ 10-100%	✓ 10-100%	✓ 10-100%
Niko	310-0190X	RLC	5-325 W	✗ 20-80%	✓ 10-100%	✓ 20-100%
Niko	330-00700	RLC	5-350 W	✗ 20-80%	✓ 10-100%	✓ 30-100%
Norwegian	KED400	R	35-400 W	✓ 10-100%	✓ 10-100%	✓ 10-100%
Norwegian	KED600	R	35-600 W	✓ 10-100%	✓ 10-100%	✓ 10-100%
Peha	433 HAB	RC	20-315 W	✗ 40-90%	✓ 10-100%	✗
Peha	434 0A	R	60-400 W	✗ 60-80%	✓ 10-100%	✗
Peha	492 AB	RC	60-525 W	✗	✗	✗
Peha	492 AN	RL	60-600 W	✗	✗	✗
Schneider (Merten)	MTN5131	R	40-400 W	✗ 20-80%	✓ 0-100%	✓ 20-100%
Schneider (Merten)	MTN5133	RL	40-600 W	✗ 20-80%	✓ 0-100%	✓ 20-100%
Schneider (Merten)	MTN5136	RC	20-315 W	✗	✗	✓ 40-100%
Schneider (Merten)	MTN5138	RLC	20-420 W	✗	✗	✗
Schneider (Merten)	MTN5139	RLC	20-600 W	✗ 20-80%	✗	✓ 30-100%
Schneider (Merten)	MTN577099	RLC	25-420 W	✗	✗	✗
Schneider (Merten)	MTN577899	RC	20-315 W	✗	✓ 20-100%	✓ 40-100%
Schneider (Merten)	MEG5170	RLC	10-200 W	✗	✗ 40-80%	✗ 40-80%

✓ = ok ✗ = not advised

HV DOWNLIGHTS

BENEFITS

- Revolutionary AC LED technology
- Can be connected directly to 220-240V outlets (no converter needed), which ensures high reliability
- Integrated NECTOR S plug system for Plug & Play installation (NECTOR is an official TE Connectivity Trademark)

FEATURES

- Dimmable with most dimmers
- Fits in standard ceiling apertures
- Low recess depth
- Suitable for concrete and false ceilings
- Powered by high quality Energy Star LED type
- Consistent color between each downlight
- Homogeneous light beam
- Antiglare protection
- No heat and UV radiation
- Waterproof front
- Comply with the latest Powerfactor norms (0.90)
- EMC test report available
- CE/ CB test report by Dekra Netherlands available
- Dutch origin according to EEC No: 1207/2001

ANNUAL SAVINGS 75 HV

Burning hours: 10 hrs x 300 days = 3000 hrs per year

Electricity savings 400 Lm:

50W - 9W = 41W x 3000 hrs = 123 kWh x €0,25 = €30,75

Maintenance cost: 2 lamps x 0,25 hr x €35 = €15

Lamp replacement cost: €4,95 x 2 = €9,90

Total annual savings: €60,77 per lamp unit.

Electricity savings 600 Lm:

50W - 11W = 39W x 3000 hrs = 117 kWh x €0,25 = €29,25

Maintenance cost: 1 lamp x 0,25 hr x €35 = €8,75

Lamp replacement cost: €11,00

Total annual savings: €49,00 per lamp unit.

ANNUAL SAVINGS 185 HV

Burning hours: 10 hrs x 300 days = 3000 hrs per year

Electricity savings 1250 Lm:

36W - 22W = 14W x 3000 hrs = 42 kWh x €0,25 = €13,-

Maintenance cost: 1 lamps x 0,25 hr x €35 = €8,75

Lamp replacement cost: 1 x €4,- = €4,-

Total annual savings: €25,75 per lamp unit.

Electricity savings 2000 Lm:

52W - 22W = 30W x 3000 hrs = 90 kWh x €0,25 = €22,50

Maintenance cost: 1 lamp x 0,25hr x €35 = €8,75

Lamp replacement cost: 1 x €4,- = €4,-

Total annual savings: €35,25 per lamp unit.