

Service Manual

Air Conditioner

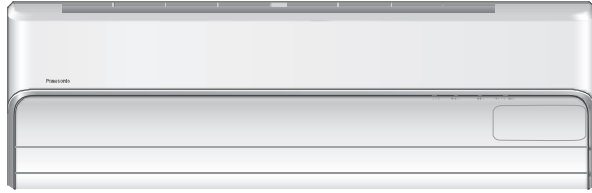

Indoor Unit
CS-LZ25TKE
CS-LZ35TKE

Outdoor Unit
CU-LZ25TKE
CU-LZ35TKE

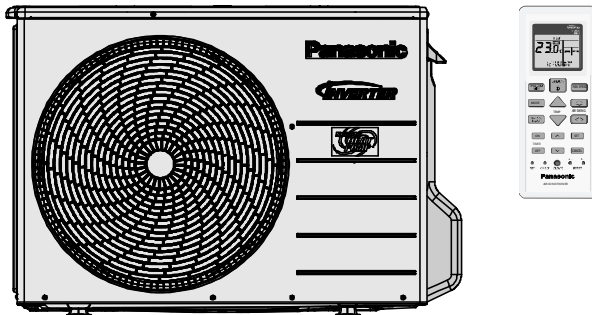

Destination
North Europe

WARNING

This service information is designed for experienced repair technicians only and is not designed for use by the general public. It does not contain warnings or cautions to advise non-technical individuals of potential dangers in attempting to service a product. Products powered by electricity should be serviced or repaired only by experienced professional technicians. Any attempt to service or repair the products dealt with in this service information by anyone else could result in serious injury or death.

IMPORTANT SAFETY NOTICE

There are special components used in this equipment which are important for safety. These parts are marked by  in the Schematic Diagrams, Circuit Board Diagrams, Exploded Views and Replacement Parts List. It is essential that these critical parts should be replaced with manufacturer's specified parts to prevent shock, fire or other hazards. Do not modify the original design without permission of manufacturer.

PRECAUTION OF LOW TEMPERATURE

In order to avoid frostbite, be assured of no refrigerant leakage during the installation or repairing of refrigerant circuit.

CAUTION



R32 REFRIGERANT – This Air Conditioner contains and operates with refrigerant R32.
THIS PRODUCT MUST ONLY BE INSTALLED OR SERVICED BY QUALIFIED PERSONNEL.
 Refer to Commonwealth, State, Territory and local legislation, regulations, codes, installation & operation manuals, before the installation, maintenance and/or service of this product.

TABLE OF CONTENTS



	PAGE		PAGE
1. Safety Precautions	3	14.8 Timer Control	62
2. Precaution for Using R32 Refrigerant	5	14.9 Auto Restart Control	62
3. Specifications	9	14.10 Indication Panel	62
4. Features	12	14.11 +8/15°C Heat Operation	63
5. Location of Controls and Components	13	15. Protection Control	64
5.1 Indoor Unit	13	15.1 Protection Control for All Operations	64
5.2 Outdoor Unit	13	15.2 Protection Control for Cooling & Soft Dry Operation	66
5.3 Remote Control	13	15.3 Protection Control for Heating Operation ..	67
6. Dimensions	14	16. Servicing Mode	68
6.1 Indoor Unit	14	16.1 Auto OFF/ON Button	68
6.2 Outdoor Unit	15	16.2 Remote Control Button	69
7. Refrigeration Cycle Diagram	16	17. Troubleshooting Guide	72
8. Block Diagram	17	17.1 Refrigeration Cycle System	72
9. Wiring Connection Diagram	18	17.2 Breakdown Self Diagnosis Function	74
9.1 Indoor Unit	18	17.3 Error Codes Table	75
9.2 Outdoor Unit	19	17.4 Self-diagnosis Method	77
10. Electronic Circuit Diagram	20	18. Disassembly and Assembly Instructions ...	105
10.1 Indoor Unit	20	18.1 Indoor Electronic Controllers, Cross Flow Fan and Indoor Fan Motor Removal Procedures	105
10.2 Outdoor Unit	21	18.2 Outdoor Electronic Controller Removal Procedure	115
11. Printed Circuit Board	22	19. Technical Data	116
11.1 Indoor Unit	22	19.1 Cool Mode Performance Data	116
11.2 Outdoor Unit	24	19.2 Heat Mode Performance Data	118
12. Installation Instruction	25	20. Service Data	119
12.1 Select the Best Location	25	20.1 Cool Mode Outdoor Air Temperature Characteristic	119
12.2 Indoor Unit	26	20.2 Heat Mode Outdoor Air Temperature Characteristic	121
12.3 Outdoor Unit	30	20.3 Piping Length Correction Factor	123
13. Installation and Servicing Air Conditioner using R32	35	21. Exploded View and Replacement Parts List.....	124
13.1 About R32 Refrigerant	35	21.1 Indoor Unit	124
13.2 Characteristics of R32 Refrigerant	35	21.2 Outdoor Unit	127
13.3 Refrigerant piping installation • Tools used in services	37		
13.4 New installation, Relocation, Repairing of Refrigerant Cycle System The Procedures	41		
13.5 Piping installation of R32	42		
13.6 Installation, Relocation, and Service	43		
13.7 Repairing of refrigerant cycle / Brazing point	47		
13.8 <Reference> Analysis method for no error code, no cooling / no warming	53		
14. Operation Control	55		
14.1 Basic Function	55		
14.2 Indoor Fan Motor Operation	56		
14.3 Outdoor Fan Motor Operation	58		
14.4 Airflow Direction	59		
14.5 Quiet Operation (Cooling Mode/Cooling Area of Dry Mode)	61		
14.6 Quiet Operation (Heating)	61		
14.7 Powerful Mode Operation	61		

1. Safety Precautions



















- Read the following “SAFETY PRECAUTIONS” carefully before installation.
- Electrical work must be installed by a licensed electrician. Be sure to use the correct rating of the power plug and main circuit for the model to be installed.
- The caution items stated here must be followed because these important contents are related to safety. The meaning of each indication used is as below. Incorrect installation due to ignoring of the instruction will cause harm or damage, and the seriousness is classified by the following indications.

 WARNING	This indication shows the possibility of causing death or serious injury.
 CAUTION	This indication shows the possibility of causing injury or damage to properties only.















- The items to be followed are classified by the symbols:

	Symbol with white background denotes item that is PROHIBITED.
 	Symbol with dark background denotes item that must be carried out.











- Carry out test running to confirm that no abnormality occurs after the installation. Then, explain to user the operation, care and maintenance as stated in instructions. Please remind the customer to keep the operating instructions for future reference.
- This appliance is not intended for accessibility by the general public.

 WARNING		
1.	Do not use means to accelerate the defrosting process or to clean, other than those recommended by the manufacturer. Any unfit method or using incompatible material may cause product damage, burst and serious injury.	
2.	Do not install outdoor unit near handrail of veranda. When installing air-conditioner unit on veranda of a high rise building, child may climb up to outdoor unit and cross over the handrail causing an accident.	
3.	Do not use unspecified cord, modified cord, joint cord or extension cord for power supply cord. Do not share the single outlet with other electrical appliances. Poor contact, poor insulation or over current will cause electrical shock or fire.	
4.	The appliance shall be stored in a well ventilated room with indoor floor area larger than A_{min} (m ²) [refer Table A] and without any continuously operating ignition source. Keep away from open flames, any operating gas appliances or any operating electric heater. Else, it may explode and cause injury or death.	
5.	Do not tie up the power supply cord into a bundle by band. Abnormal temperature rise on power supply cord may happen.	
6.	Do not insert your fingers or other objects into the unit, high speed rotating fan may cause injury. 	
7.	Do not sit or step on the unit, you may fall down accidentally. 	
8.	The appliance shall be installed, and/or operated in a room with floor area larger than A_{min} (m ²) [refer Table A] and keep away from ignition sources, such as heat/sparks/open flame or hazardous areas such as gas appliances, gas cooking, reticulated gas supply systems or electric cooking appliances, etc.	
9.	Keep plastic bag (packaging material) away from small children, it may cling to nose and mouth and prevent breathing.	
10.	When installing or relocating air conditioner, do not let any substance other than the specified refrigerant, eg. air etc mix into refrigeration cycle (piping). Mixing of air etc. will cause abnormal high pressure in refrigeration cycle and result in explosion, injury etc.	
11.	Do not pierce or burn as the appliance is pressurized. Do not expose the appliance to heat, flame, sparks, or other sources of ignition. Else, it may explode and cause injury or death.	
12.	Do not add or replace refrigerant other than specified type. It may cause product damage, burst and injury etc.	
13.	Do not perform flare connection inside a building or dwelling or room, when joining the heat exchanger of indoor unit with interconnecting piping. Refrigerant connection inside a building or dwelling or room must be made by brazing or welding. Joint connection of indoor unit by flaring method can only be made at outdoor or at outside of a building or dwelling or room. Flare connection may cause gas leak and flammable atmosphere.	
14.	<ul style="list-style-type: none"> • For R32 model, use piping, flare nut and tools which is specified for R32 refrigerant. Using of existing (R22) piping, flare nut and tools may cause abnormally high pressure in the refrigerant cycle (piping), and possibly result in explosion and injury. • Thickness for copper pipes used with R32 must be more than 0.8 mm. Never use copper pipes thinner than 0.8 mm. • It is desirable that the amount of residual oil less than 40 mg/10 m. 	
15.	Engage authorized dealer or specialist for installation. If installation done by the user is incorrect, it will cause water leakage, electrical shock or fire.	

 **WARNING**

16.	For refrigeration system work, install according to this installation instructions strictly. If installation is defective, it will cause water leakage, electrical shock or fire.	
17.	Use the attached accessories parts and specified parts for installation. Otherwise, it will cause the set to fall, water leakage, fire or electrical shock.	
18.	Install at a strong and firm location which is able to withstand weight of the set. If the strength is not enough or installation is not properly done, the set will drop and cause injury.	
19.	For electrical work, follow the national regulation, legislation and this installation instructions. An independent circuit and single outlet must be used. If electrical circuit capacity is not enough or defect found in the electrical work, it will cause electrical shock or fire.	
20.	Do not use joint cable for indoor/outdoor connection cable. Use the specified indoor/outdoor connection cable, refer to instruction ⑤ CONNECT THE CABLE TO THE INDOOR UNIT and connect tightly for indoor/outdoor connection. Clamp the cable so that no external force will have impact on the terminal. If connection or fixing is not perfect, it will cause heat up or fire at the connection.	
21.	Wire routing must be properly arranged so that control board cover is fixed properly. If control board cover is not fixed perfectly, it will cause fire or electrical shock.	
22.	This equipment is strongly recommended to be installed with Earth Leakage Circuit Breaker (ELCB) or Residual Current Device (RCD), with sensitivity of 30mA at 0.1 sec or less. Otherwise, it may cause electrical shock and fire in case of equipment breakdown or insulation breakdown.	
23.	During installation, install the refrigerant piping properly before running the compressor. Operation of compressor without fixing refrigeration piping and valves at opened position will cause suck-in of air, abnormal high pressure in refrigeration cycle and result in explosion, injury etc.	
24.	During pump down operation, stop the compressor before removing the refrigeration piping. Removal of refrigeration piping while compressor is operating and valves are opened will cause suck-in of air, abnormal high pressure in refrigeration cycle and result in explosion, injury etc.	
25.	Tighten the flare nut with torque wrench according to specified method. If the flare nut is over-tightened, after a long period, the flare may break and cause refrigerant gas leakage.	
26.	After completion of installation, confirm there is no leakage of refrigerant gas. It may generate toxic gas when the refrigerant contacts with fire.	
27.	Ventilate if there is refrigerant gas leakage during operation. It may cause toxic gas when the refrigerant contacts with fire.	
28.	Be aware that refrigerants may not contain an odour.	
29.	This equipment must be properly earthed. Earth line must not be connected to gas pipe, water pipe, earth of lightning rod and telephone. Otherwise, it may cause electrical shock in case of equipment breakdown or insulation breakdown.	

 **CAUTION**

1.	Do not install the unit in a place where leakage of flammable gas may occur. In case gas leaks and accumulates at surrounding of the unit, it may cause fire.	
2.	Prevent liquid or vapor from entering sumps or sewers since vapor is heavier than air and may form suffocating atmospheres.	
3.	Do not release refrigerant during piping work for installation, re-installation and during repairing refrigeration parts. Take care of the liquid refrigerant, it may cause frostbite.	
4.	Do not install this appliance in a laundry room or other location where water may drip from the ceiling, etc.	
5.	Do not touch the sharp aluminium fin, sharp parts may cause injury. 	
6.	Carry out drainage piping as mentioned in installation instructions. If drainage is not perfect, water may enter the room and damage the furniture.	
7.	Select an installation location which is easy for maintenance. Incorrect installation, service or repair of this air conditioner may increase the risk of rupture and this may result in loss damage or injury and/or property.	
8.	Power supply connection to the room air conditioner. Use power supply cord 3 × 1.5 mm ² type designation 60245 IEC 57 or heavier cord. Connect the power supply cord of the air conditioner to the mains using one of the following method. Power supply point should be in easily accessible place for power disconnection in case of emergency. In some countries, permanent connection of this air conditioner to the power supply is prohibited. 1) Power supply connection to the receptacle using power plug. Use an approved 15/16A power plug with earth pin for the connection to the socket. 2) Power supply connection to a circuit breaker for the permanent connection. Use an approved 16A circuit breaker for the permanent connection. It must be a double pole switch with a minimum 3.0 mm contact gap.	
9.	Installation work. It may need two people to carry out the installation work.	

2. Precaution for Using R32 Refrigerant

- The basic installation work procedures are the same as conventional refrigerant (R410A, R22) models.
- However, pay careful attention to the following points:

 WARNING	
Since the working pressure is higher than that of refrigerant R22 models, some of the piping and installation and service tools are special.	
1.	Especially, when replacing a refrigerant R22 model with a new refrigerant R32 model, always replace the conventional piping and flare nuts with the R32 and R410A piping and flare nuts on the outdoor unit side. For R32 and R410A, the same flare nut on the outdoor unit side and pipe can be used.
2.	Models that use refrigerant R32 and R410A have a different charging port thread diameter to prevent erroneous charging with refrigerant R22 and for safety. Therefore, check beforehand. [The charging port thread diameter for R32 and R410A is 12.7 mm (1/2 inch).]
3.	Be more careful than R22 so that foreign matter (oil, water, etc.) does not enter the piping. Also, when storing the piping, securely seal the opening by pinching, taping, etc. (Handling of R32 is similar to R410A.)

 CAUTION	
Installation (Space) <ul style="list-style-type: none"> • Must ensure the installation of pipe-work shall be kept to a minimum. Avoid use dented pipe and do not allow acute bending. • Must ensure that pipe-work shall be protected from physical damage. • Must comply with national gas regulations, state municipal rules and legislation. Notify relevant authorities in accordance with all applicable regulations. 	
1.	<ul style="list-style-type: none"> • Must ensure mechanical connections be accessible for maintenance purposes. • In cases that require mechanical ventilation, ventilation openings shall be kept clear of obstruction. • When disposal of the product, do follow to the precautions in #12 and comply with national regulations. Always contact to local municipal offices for proper handling.
Servicing 2-1. Service personnel <ul style="list-style-type: none"> • Any qualified person who is involved with working on or breaking into a refrigerant circuit should hold a current valid certificate from an industry-accredited assessment authority, which authorizes their competence to handle refrigerants safely in accordance with an industry recognised assessment specification. • Servicing shall only be performed as recommended by the equipment manufacturer. Maintenance and repair requiring the assistance of other skilled personnel shall be carried out under the supervision of the person competent in the use of flammable refrigerants. • Servicing shall be performed only as recommended by the manufacturer. 	
2-2. Work <ul style="list-style-type: none"> • Prior to beginning work on systems containing flammable refrigerants, safety checks are necessary to ensure that the risk of ignition is minimised. For repair to the refrigerating system, the precautions in #2-2 to #2-8 must be followed before conducting work on the system. • Work shall be undertaken under a controlled procedure so as to minimize the risk of a flammable gas or vapour being present while the work is being performed. • All maintenance staff and others working in the local area shall be instructed and supervised on the nature of work being carried out. • Avoid working in confined spaces. • Wear appropriate protective equipment, including respiratory protection, as conditions warrant. • Ensure that the conditions within the area have been made safe by limit of use of any flammable material. Keep all sources of ignition and hot metal surfaces away. 	
2.	2-3. Checking for presence of refrigerant <ul style="list-style-type: none"> • The area shall be checked with an appropriate refrigerant detector prior to and during work, to ensure the technician is aware of potentially flammable atmospheres. • Ensure that the leak detection equipment being used is suitable for use with flammable refrigerants, i.e. non sparking, adequately sealed or intrinsically safe. • In case of leakage/spillage happened, immediately ventilate area and stay upwind and away from spill/release. • In case of leakage/spillage happened, do notify persons down wind of the leaking/spill, isolate immediate hazard area and keep unauthorized personnel out.
2-4. Presence of fire extinguisher <ul style="list-style-type: none"> • If any hot work is to be conducted on the refrigeration equipment or any associated parts, appropriate fire extinguishing equipment shall be available at hand. • Have a dry powder or CO₂ fire extinguisher adjacent to the charging area. 	
2-5. No ignition sources <ul style="list-style-type: none"> • No person carrying out work in relation to a refrigeration system which involves exposing any pipe work that contains or has contained flammable refrigerant shall use any sources of ignition in such a manner that it may lead to the risk of fire or explosion. He/She must not be smoking when carrying out such work. • All possible ignition sources, including cigarette smoking, should be kept sufficiently far away from the site of installation, repairing, removing and disposal, during which flammable refrigerant can possibly be released to the surrounding space. • Prior to work taking place, the area around the equipment is to be surveyed to make sure that there are no flammable hazards or ignition risks. • "No Smoking" signs shall be displayed. 	
2-6. Ventilated area <ul style="list-style-type: none"> • Ensure that the area is in the open or that it is adequately ventilated before breaking into the system or conducting any hot work. • A degree of ventilation shall continue during the period that the work is carried out. • The ventilation should safely disperse any released refrigerant and preferably expel it externally into the atmosphere. 	

 **CAUTION**

2-7. Checks to the refrigeration equipment

- Where electrical components are being changed, they shall be fit for the purpose and to the correct specification.
- At all times the manufacturer's maintenance and service guidelines shall be followed.
- If in doubt consult the manufacturer's technical department for assistance.
- The following checks shall be applied to installations using flammable refrigerants.
 - The charge size is in accordance with the room size within which the refrigerant containing parts are installed.
 - The ventilation machinery and outlets are operating adequately and are not obstructed.
 - If an indirect refrigerating circuit is being used, the secondary circuit shall be checked for the presence of refrigerant.
 - Marking to the equipment continues to be visible and legible. Markings and signs that are illegible shall be corrected.
 - Refrigeration pipe or components are installed in a position where they are unlikely to be exposed to any substance which may corrode refrigerant containing components, unless the components are constructed of materials which are inherently resistant to being corroded or are properly protected against being so corroded.

2-8. Checks to electrical devices

- Repair and maintenance to electrical components shall include initial safety checks and component inspection procedures.
- Initial safety checks shall include but not limit to:-
 - That capacitors are discharged: this shall be done in a safe manner to avoid possibility of sparking.
 - That there is no live electrical components and wiring are exposed while charging, recovering or purging the system.
 - That there is continuity of earth bonding.
- At all times the manufacturer's maintenance and service guidelines shall be followed.
- If in doubt consult the manufacturer's technical department for assistance.
- If a fault exists that could compromise safety, then no electrical supply shall be connected to the circuit until it is satisfactorily dealt with.
- If the fault cannot be corrected immediately but it is necessary to continue operation, an adequate temporary solution shall be used.
- The owner of the equipment must be informed or reported so all parties are advised thereafter.

Repairs to sealed components

- During repairs to sealed components, all electrical supplies shall be disconnected from the equipment being worked upon prior to any removal of sealed covers, etc.
 - If it is absolutely necessary to have an electrical supply to equipment during servicing, then a permanently operating form of leak detection shall be located at the most critical point to warn of a potentially hazardous situation.
 - Particular attention shall be paid to the following to ensure that by working on electrical components, the casing is not altered in such a way that the level of protection is affected. This shall include damage to cables, excessive number of connections, terminals not made to original specification, damage to seals, incorrect fitting of glands, etc.
- 3.
- Ensure that apparatus is mounted securely.
 - Ensure that seals or sealing materials have not degraded such that they no longer serve the purpose of preventing the ingress of flammable atmospheres.
 - Replacement parts shall be in accordance with the manufacturer's specifications.

<p>NOTE: The use of silicon sealant may inhibit the effectiveness of some types of leak detection equipment. Intrinsically safe components do not have to be isolated prior to working on them.</p>
--

Repair to intrinsically safe components

- Do not apply any permanent inductive or capacitance loads to the circuit without ensuring that this will not exceed the permissible voltage and current permitted for the equipment in use.
- 4.
- Intrinsically safe components are the only types that can be worked on while live in the presence of a flammable atmosphere.
 - The test apparatus shall be at the correct rating.
 - Replace components only with parts specified by the manufacturer. Unspecified parts by manufacturer may result ignition of refrigerant in the atmosphere from a leak.

Cabling

- Check that cabling will not be subject to wear, corrosion, excessive pressure, vibration, sharp edges or any other adverse environmental effects.
 - The check shall also take into account the effects of aging or continual vibration from sources such as compressors or fans.
- 5.

Detection of flammable refrigerants

- Under no circumstances shall potential sources of ignition be used in the searching or detection of refrigerant leaks.
 - A halide torch (or any other detector using a naked flame) shall not be used.
- 6.

Leak detection methods

- Electronic leak detectors shall be used to detect flammable refrigerants, but the sensitivity may not be adequate, or may need re-calibration.
(Detection equipment shall be calibrated in a refrigerant-free area.)
 - Ensure that the detector is not a potential source of ignition and is suitable for the refrigerant used.
 - Leak detection equipment shall be set at a percentage of the LFL of the refrigerant and shall be calibrated to the refrigerant employed and the appropriate percentage of gas (25 % maximum) is confirmed.
- 7.
- Leak detection fluids are suitable for use with most refrigerants but the use of detergents containing chlorine shall be avoided as the chlorine may react with the refrigerant and corrode the copper pipe-work.
 - If a leak is suspected, all naked flames shall be removed/extinguished.
 - If a leakage of refrigerant is found which requires brazing, all of the refrigerant shall be recovered from the system, or isolated (by means of shut off valves) in a part of the system remote from the leak. Oxygen free nitrogen (OFN) shall then be purged through the system both before and during the brazing process.

 **CAUTION**

Removal and evacuation

- When breaking into the refrigerant circuit to make repairs – or for any other purpose – conventional procedures shall be used. However, it is important that best practice is followed since flammability is a consideration. The following procedure shall be adhered to:

- remove refrigerant ->
- purge the circuit with inert gas ->
- evacuate ->
- purge again with inert gas ->
- open the circuit by cutting or brazing

- 8.
- The refrigerant charge shall be recovered into the correct recovery cylinders.
 - The system shall be “flushed” with OFN to render the unit safe.
 - This process may need to be repeated several times.
 - Compressed air or oxygen shall not be used for this task.
 - Flushing shall be achieved by breaking the vacuum in the system with OFN and continuing to fill until the working pressure is achieved, then venting to atmosphere, and finally pulling down to a vacuum.
 - This process shall be repeated until no refrigerant is within the system.
 - When the final OFN charge is used, the system shall be vented down to atmospheric pressure to enable work to take place.
 - This operation is absolutely vital if brazing operations on the pipe work are to take place.
 - Ensure that the outlet for the vacuum pump is not close to any ignition sources and there is ventilation available.

Charging procedures

- 9.
- In addition to conventional charging procedures, the following requirements shall be followed.
 - Ensure that contamination of different refrigerants does not occur when using charging equipment.
 - Hoses or lines shall be as short as possible to minimize the amount of refrigerant contained in them.
 - Cylinders shall be kept upright.
 - Ensure that the refrigeration system is earthed prior to charging the system with refrigerant.
 - Label the system when charging is complete (if not already).
 - Extreme care shall be taken not to over fill the refrigeration system.
 - Prior to recharging the system it shall be pressure tested with OFN (refer to #7).
 - The system shall be leak tested on completion of charging but prior to commissioning.
 - A follow up leak test shall be carried out prior to leaving the site.
 - Electrostatic charge may accumulate and create a hazardous condition when charging and discharging the refrigerant. To avoid fire or explosion, dissipate static electricity during transfer by grounding and bonding containers and equipment before charging/discharging.

Decommissioning

- 10.
- Before carrying out this procedure, it is essential that the technician is completely familiar with the equipment and all its details.
 - It is recommended good practice that all refrigerants are recovered safely.
 - Prior to the task being carried out, an oil and refrigerant sample shall be taken in case analysis is required prior to re-use of reclaimed refrigerant.
 - It is essential that electrical power is available before the task is commenced.
 - a) Become familiar with the equipment and its operation.
 - b) Isolate system electrically.
 - c) Before attempting the procedure ensure that:
 - mechanical handling equipment is available, if required, for handling refrigerant cylinders;
 - all personal protective equipment is available and being used correctly;
 - the recovery process is supervised at all times by a competent person;
 - recovery equipment and cylinders conform to the appropriate standards.
 - d) Pump down refrigerant system, if possible.
 - e) If a vacuum is not possible, make a manifold so that refrigerant can be removed from various parts of the system.
 - f) Make sure that cylinder is situated on the scales before recovery takes place.
 - g) Start the recovery machine and operate in accordance with manufacturer’s instructions.
 - h) Do not over fill cylinders. (No more than 80 % volume liquid charge).
 - i) Do not exceed the maximum working pressure of the cylinder, even temporarily.
 - j) When the cylinders have been filled correctly and the process completed, make sure that the cylinders and the equipment are removed from site promptly and all isolation valves on the equipment are closed off.
 - k) Recovered refrigerant shall not be charged into another refrigeration system unless it has been cleaned and checked.
 - Electrostatic charge may accumulate and create a hazardous condition when charging or discharging the refrigerant. To avoid fire or explosion, dissipate static electricity during transfer by grounding and bonding containers and equipment before charging/discharging.

 CAUTION

Labelling

- 11.
- Equipment shall be labelled stating that it has been de-commissioned and emptied of refrigerant.
 - The label shall be dated and signed.
 - Ensure that there are labels on the equipment stating the equipment contains flammable refrigerant.

Recovery

- When removing refrigerant from a system, either for servicing or decommissioning, it is recommended good practice that all refrigerants are removed safely.
 - When transferring refrigerant into cylinders, ensure that only appropriate refrigerant recovery cylinders are employed.
 - Ensure that the correct number of cylinders for holding the total system charge are available.
 - All cylinders to be used are designated for the recovered refrigerant and labelled for that refrigerant (i.e. special cylinders for the recovery of refrigerant).
 - Cylinders shall be complete with pressure relief valve and associated shut-off valves in good working order.
 - Recovery cylinders are evacuated and, if possible, cooled before recovery occurs.
 - The recovery equipment shall be in good working order with a set of instructions concerning the equipment that is at hand and shall be suitable for the recovery of concerning the equipment that is at hand and shall be suitable for the recovery of flammable refrigerants.
- 12.
- In addition, a set of calibrated weighing scales shall be available and in good working order.
 - Hoses shall be complete with leak-free disconnect couplings and in good condition.
 - Before using the recovery machine, check that it is in satisfactory working order, has been properly maintained and that any associated electrical components are sealed to prevent ignition in the event of a refrigerant release. Consult manufacturer if in doubt.
 - The recovered refrigerant shall be returned to the refrigerant supplier in the correct recovery cylinder, and the relevant Waste Transfer Note arranged.
 - Do not mix refrigerants in recovery units and especially not in cylinders.
 - If compressors or compressor oils are to be removed, ensure that they have been evacuated to an acceptable level to make certain that flammable refrigerant does not remain within the lubricant.
 - The evacuation process shall be carried out prior to returning the compressor to the suppliers.
 - Only electric heating to the compressor body shall be employed to accelerate this process.
 - When oil is drained from a system, it shall be carried out safely.

3. Specifications

Model		Indoor	CS-LZ25TKE			CS-LZ35TKE				
		Outdoor	CU-LZ25TKE			CU-LZ35TKE				
Performance Test Condition		EUROVENT			EUROVENT					
Power Supply		Phase, Hz	Single, 50			Single, 50				
		V	230			230				
		Min.	Mid.	Max.	Min.	Mid.	Max.			
Cooling	Capacity		kW	0.85	2.50	3.00	0.85	3.50	4.00	
			BTU/h	2900	8530	10200	2900	11900	13600	
			Kcal/h	730	2150	2580	730	3010	3440	
	Running Current		A	–	2.40	–	–	3.95	–	
	Input Power		W	170	505	695	170	855	1080	
	Annual Consumption		kWh	–	228	–	–	415	–	
	EER		W/W	5.00	4.95	4.32	5.00	4.09	3.70	
			BTU/hW	17.06	16.89	14.68	17.06	13.92	12.59	
			Kcal/hW	4.29	4.26	3.71	4.29	3.52	3.19	
	ErP	Pdesign	kW	2.5			3.5			
		SEER	(W/W)	7.6			7.4			
		Annual Consumption	kWh	115			166			
		Class		A++			A++			
	Power Factor		%	–	91	–	–	94	–	
	Indoor Noise (H / L / QLo)		dB-A	40 / 25 / 21			43 / 28 / 21			
			Power Level dB	56 / – / –			59 / – / –			
	Outdoor Noise (H / L / QLo)		dB-A	46 / – / 43			48 / – / 45			
			Power Level dB	61 / – / –			63 / – / –			
	Heating	Capacity		kW	0.85	3.20	6.55	0.85	4.20	7.65
				BTU/h	2900	10900	22300	2900	14300	26100
Kcal/h				730	2750	5630	730	3610	6580	
Running Current		A	–	2.90	–	–	4.10	–		
Input Power		W	165	625	1.77k	165	890	2.30k		
COP		W/W	5.15	5.12	3.70	5.15	4.72	3.33		
		BTU/hW	17.58	17.44	12.60	17.58	16.07	11.35		
		Kcal/hW	4.42	4.40	3.18	4.42	4.06	2.86		
ErP		Pdesign	kW	3.0			3.8			
		Tbivalent	°C	-10			-10			
		SCOP	(W/W)	5.0			4.9			
		Annual Consumption	kWh	840			1086			
		Class		A++			A++			
Power Factor		%	–	94	–	–	94	–		
Indoor Noise (H / L / QLo)		dB-A	45 / 29 / 18			46 / 30 / 19				
		Power Level dB	61 / – / –			62 / – / –				
Outdoor Noise (H / L / QLo)		dB-A	47 / – / 44			50 / – / 47				
		Power Level dB	62 / – / –			65 / – / –				
Low Temp. : Capacity (kW) / I.Power (W) / COP		4.75 / 1.57k / 3.03			5.54 / 2.04k / 2.72					
Extr Low Temp. : Capacity (kW) / I.Power (W) / COP		4.00 / 1.59k / 2.52			4.60 / 1.96k / 2.35					
Max Current (A) / Max Input Power (W)		8.0 / 1.77k			10.1 / 2.30k					
Starting Current (A)		2.90			4.10					

Model			Indoor	CS-LZ25TKE	CS-LZ35TKE	
			Outdoor	CU-LZ25TKE	CU-LZ35TKE	
Compressor	Type			Hermetic Motor (Rotary)	Hermetic Motor (Rotary)	
	Motor Type			Brushless (4-poles)	Brushless (4-poles)	
	Output Power		W	900	900	
Indoor Fan	Type			Cross-Flow Fan	Cross-Flow Fan	
	Material			ASG20K1	ASG20K1	
	Motor Type			DC / Transistor (8-poles)	DC / Transistor (8-poles)	
	Input Power		W	48.0	48.0	
	Output Power		W	40	40	
	Speed	QLo	Cool	rpm	530	530
			Heat	rpm	520	540
		Lo	Cool	rpm	590	640
			Heat	rpm	750	760
		Me	Cool	rpm	770	850
			Heat	rpm	980	1000
		Hi	Cool	rpm	960	1060
			Heat	rpm	1220	1250
	SHi	Cool	rpm	1010	1110	
Heat		rpm	1330	1370		
Outdoor Fan	Type			Propeller Fan	Propeller Fan	
	Material			PP	PP	
	Motor Type			DC (8-poles)	DC (8-poles)	
	Input Power		W	-	-	
	Output Power		W	40	40	
	Speed	Hi	Cool	rpm	850	860
			Heat	rpm	850	890
Moisture Removal			L/h (Pt/h)	1.5 (3.2)	2.0 (4.2)	
Indoor Airflow	QLo	Cool	m ³ /min (ft ³ /min)	4.43 (156)	4.43 (156)	
		Heat	m ³ /min (ft ³ /min)	4.31 (152)	4.54 (160)	
	Lo	Cool	m ³ /min (ft ³ /min)	5.11 (180)	5.68 (201)	
		Heat	m ³ /min (ft ³ /min)	6.93 (245)	7.05 (249)	
	Me	Cool	m ³ /min (ft ³ /min)	7.22 (255)	8.07 (285)	
		Heat	m ³ /min (ft ³ /min)	9.61 (339)	9.84 (347)	
	Hi	Cool	m ³ /min (ft ³ /min)	9.30 (330)	10.50 (370)	
		Heat	m ³ /min (ft ³ /min)	12.50 (440)	13.00 (460)	
SHi	Cool	m ³ /min (ft ³ /min)	9.90 (350)	11.04 (390)		
	Heat	m ³ /min (ft ³ /min)	13.55 (478)	14.00 (494)		
Outdoor Airflow	Hi	Cool	m ³ /min (ft ³ /min)	33.10 (1170)	34.40 (1215)	
		Heat	m ³ /min (ft ³ /min)	34.00 (1200)	35.60 (1255)	
Refrigeration Cycle	Control Device			Expansion Valve	Expansion Valve	
	Refrigerant Oil		cm ³	FW50S (450)	FW50S (450)	
	Refrigerant Type		g (oz)	R32, 1.10k (38.8)	R32, 1.10k (38.8)	
F-Gas	GWP			675	675	
	CO2eq (ton) (Precharged Amount / Maximum Charged Amount)			0.743 / 0.911	0.743 / 0.911	
Dimension	Height (I/D / O/D)		mm (inch)	249 (9-13/16) / 622 (24-1/2)	249 (9-13/16) / 622 (24-1/2)	
	Width (I/D / O/D)		mm (inch)	790 (31-1/8) / 824 (32-15/32)	790 (31-1/8) / 824 (32-15/32)	
	Depth (I/D / O/D)		mm (inch)	355 (14) / 299 (11-25/32)	355 (14) / 299 (11-25/32)	
Weight	Net (I/D / O/D)		kg (lb)	11 (24) / 38 (84)	11 (24) / 38 (84)	

Model		Indoor	CS-LZ25TKE		CS-LZ35TKE	
		Outdoor	CU-LZ25TKE		CU-LZ35TKE	
Piping	Pipe Diameter (Liquid / Gas)	mm (inch)	6.35 (1/4) / 9.52 (3/8)		6.35 (1/4) / 9.52 (3/8)	
	Standard length	m (ft)	5.0 (16.4)		5.0 (16.4)	
	Length range (min – max)	m (ft)	3 (9.8) ~ 20 (65.6)		3 (9.8) ~ 20 (65.6)	
	I/D & O/D Height different	m (ft)	10.0 (32.8)		10.0 (32.8)	
	Additional Gas Amount	g/m (oz/ft)	20 (0.2)		20 (0.2)	
	Length for Additional Gas	m (ft)	7.5 (24.6)		7.5 (24.6)	
Drain Hose	Inner Diameter	mm	16.7		16.7	
	Length	mm	650		650	
Indoor Heat Exchanger	Fin Material		Aluminium (Pre Coat)		Aluminium (Pre Coat)	
	Fin Type		Hybrid Eva		Hybrid Eva	
	Row × FPI		4 × 21		4 × 21	
	Width	mm	610		610	
Outdoor Heat Exchanger	Fin Material		Aluminium		Aluminium	
	Fin Type		Corrugated Fin		Corrugated Fin	
	Row × Stage × FPI		2 × 28 × 19		2 × 28 × 19	
	Size (W × H × L)	mm	36.4 × 588 × 856.3:827.7		36.4 × 588 × 856.3:827.7	
Air Filter	Material		Polypropelene		Polypropelene	
	Type		One-touch		One-touch	
Power Supply			Outdoor		Outdoor	
Power Supply Cord		A	Nil		Nil	
Thermostat			Electronic Contol		Electronic Contol	
Protection Device			Electronic Contol		Electronic Contol	
			Dry Bulb	Wet Bulb	Dry Bulb	Wet Bulb
Indoor Operation Range	Cooling	Maximum °C (°F)	32 (89.6)	23 (73.4)	32 (89.6)	23 (73.4)
		Maximum °C (°F)	16 (60.8)	11 (51.8)	16 (60.8)	11 (51.8)
	Heating	Maximum °C (°F)	30 (86.0)	–	30 (86.0)	–
		Maximum °C (°F)	16 (60.8)	–	16 (60.8)	–
	+8/15°C Heat	Maximum °C (°F)	15 (59.0)	–	15 (59.0)	–
		Maximum °C (°F)	8 (46.4)	–	8 (46.4)	–
Outdoor Operation Range	Cooling	Maximum °C (°F)	43 (109.4)	26 (78.8)	43 (109.4)	26 (78.8)
		Maximum °C (°F)	-15 (5.0)	11 (51.8)	-15 (5.0)	11 (51.8)
	Heating	Maximum °C (°F)	24 (75.2)	18 (64.4)	24 (75.2)	18 (64.4)
		Maximum °C (°F)	-20 (-4.0)	–	-20 (-4.0)	–
	+8/15°C Heat	Maximum °C (°F)	–	–	–	–
		Maximum °C (°F)	-20 (-4.0)	–	-20 (-4.0)	–

- Cooling capacities are based on indoor temperature of 27°C Dry Bulb (80.6°F Dry Bulb), 19.0°C Wet Bulb (66.2°F Wet Bulb) and outdoor air temperature of 35°C DRY BULB (95°F Dry Bulb), 24°C Wet Bulb (75.2°F Wet Bulb).
- Heating capacities are based on indoor temperature of 20°C Dry Bulb (68°F Dry Bulb) and outdoor air temperature of 7°C Dry Bulb (44.6°F Dry Bulb), 6°C Wet Bulb (42.8°F Wet Bulb).
- Heating low temperature capacity, Input Power and COP measured at 230 V, indoor temperature 20°C, outdoor 2/1°C.
- Heating extreme low temperature capacity, Input Power and COP measured at 230 V, indoor temperature 20°C, outdoor -7/-8°C.
- Standby power consumption ≤10.0w (when switched OFF by remote control, except under self protection control).
- Specifications are subjected to change without prior notice for further improvement.

4. Features

- **Inverter Technology**
 - Wider output power range
 - Energy saving
 - Quick Cooling
 - Quick Heating
 - More precise temperature control
- **Environment Protection**
 - Non-ozone depletion substances refrigerant (R32)
- **Long Installation Piping**
 - Long piping up to 20 meters during single split connection only
- **Easy to use remote control**
- **Quality Improvement**
 - Random auto restart after power failure for safety restart operation
 - Gas leakage protection
 - Prevent compressor reverse cycle
 - Inner protector to protect compressor
 - Noise prevention during soft dry operation
- **Operation Improvement**
 - Quiet mode to reduce the indoor unit operating sound
 - Powerful mode to reach the desired room temperature quickly
 - 24-hour timer setting
 - +8/15°C HEAT operation is designed to provide heating at low temperature settings. It is used in houses unoccupied during winter, for the purpose of protecting equipment or housing appliances which may be destroyed by extreme cold weather.
- **Serviceability Feature**
 - Activation and Deactivation Method for Heating Only Mode
 - Breakdown Self Diagnosis function

5. Location of Controls and Components

5.1 Indoor Unit

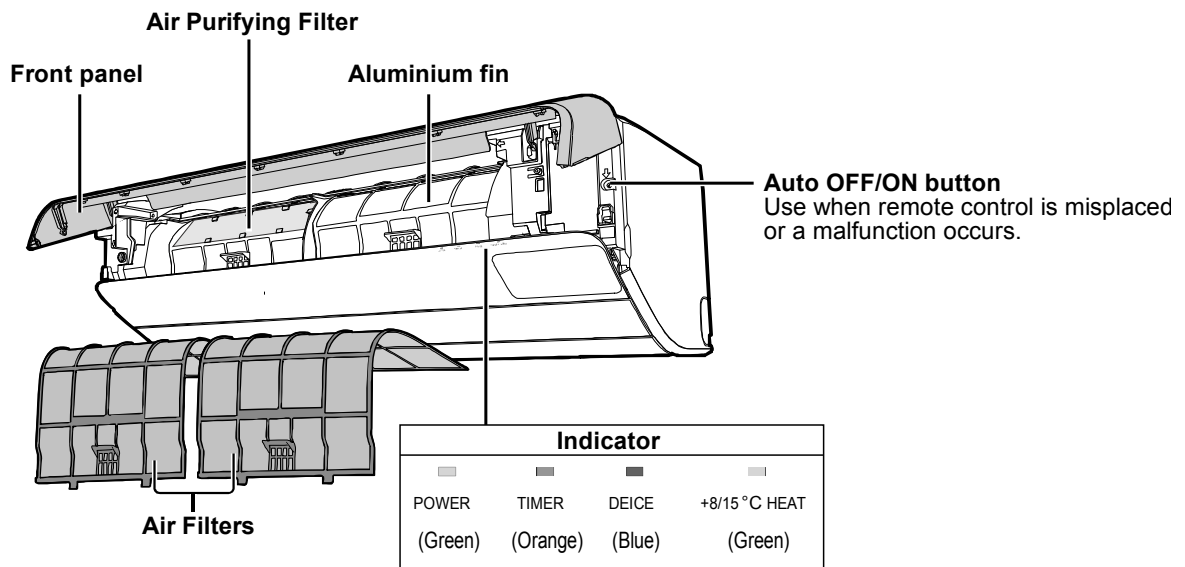

5.2 Outdoor Unit

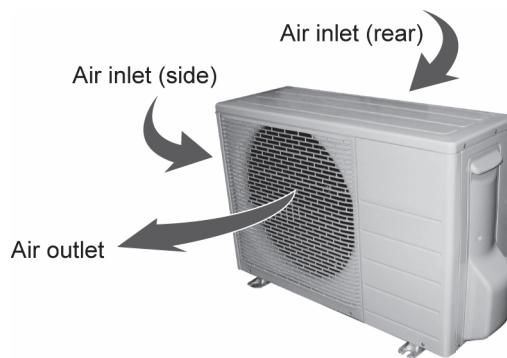

5.3 Remote Control

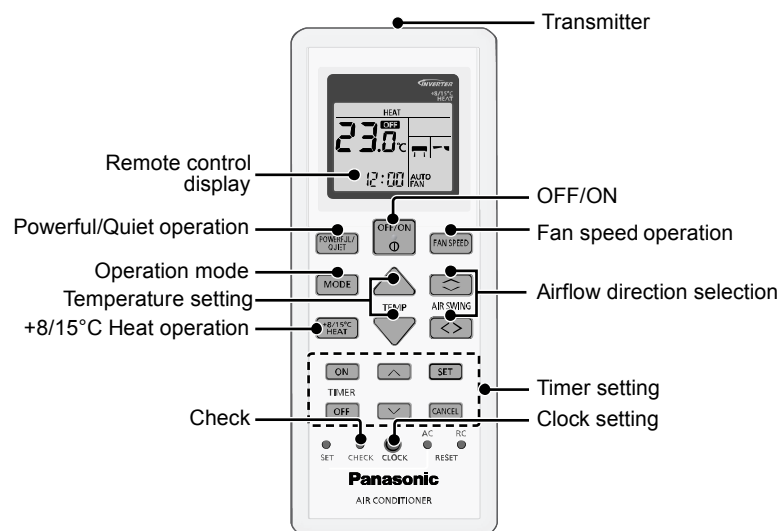

6. Dimensions

6.1 Indoor Unit

<Top View>

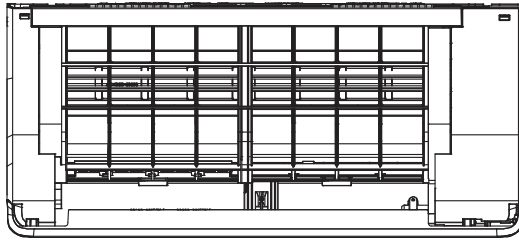

<Side View>

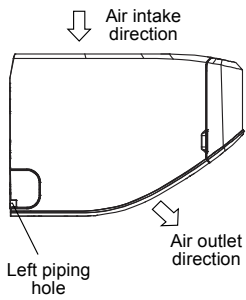

<Front View>

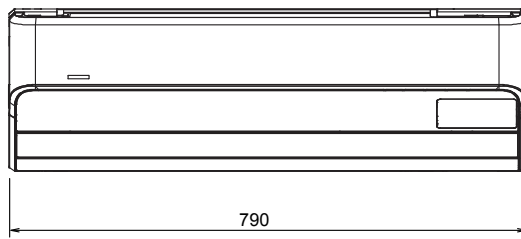

<Side View>

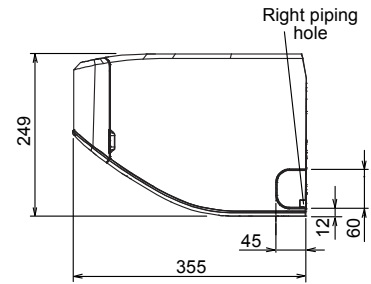

<Bottom View>

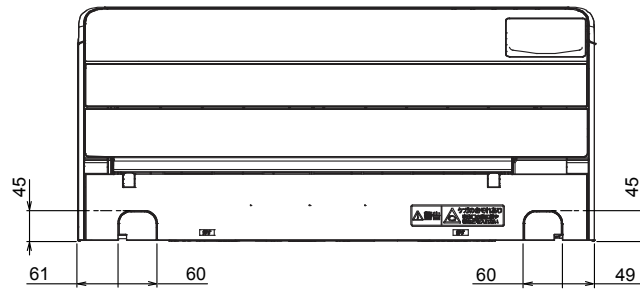

<Remote Control>

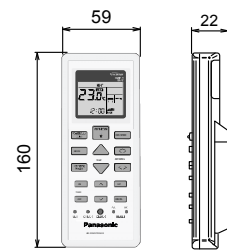

<Rear View>

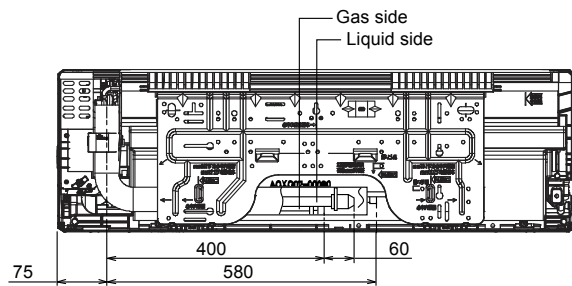

<Remote Control Holder>

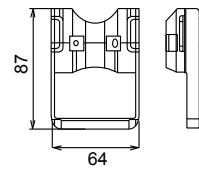

Relative position between the indoor unit and the installation plate <Front View>

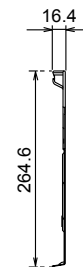
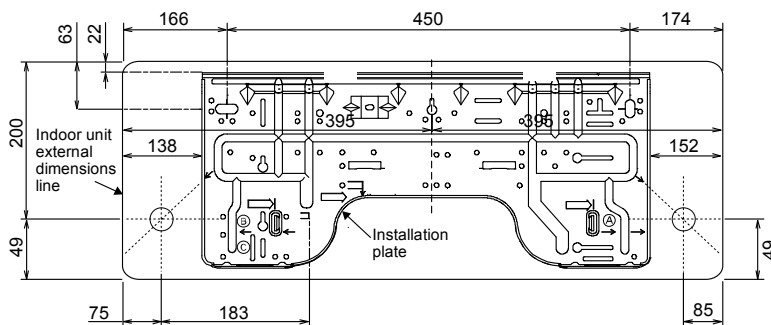

Unit: mm

6.2 Outdoor Unit

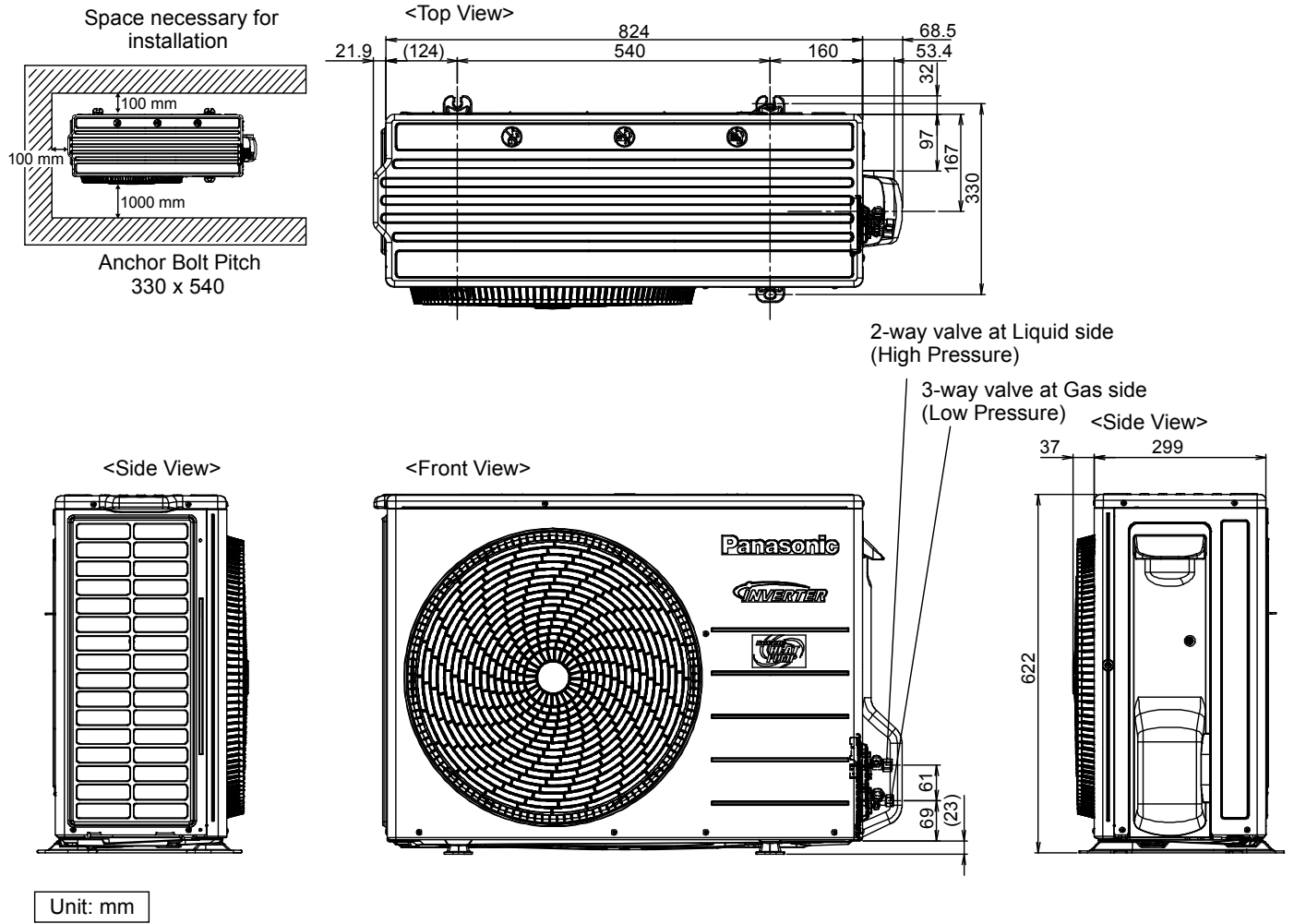

7. Refrigeration Cycle Diagram

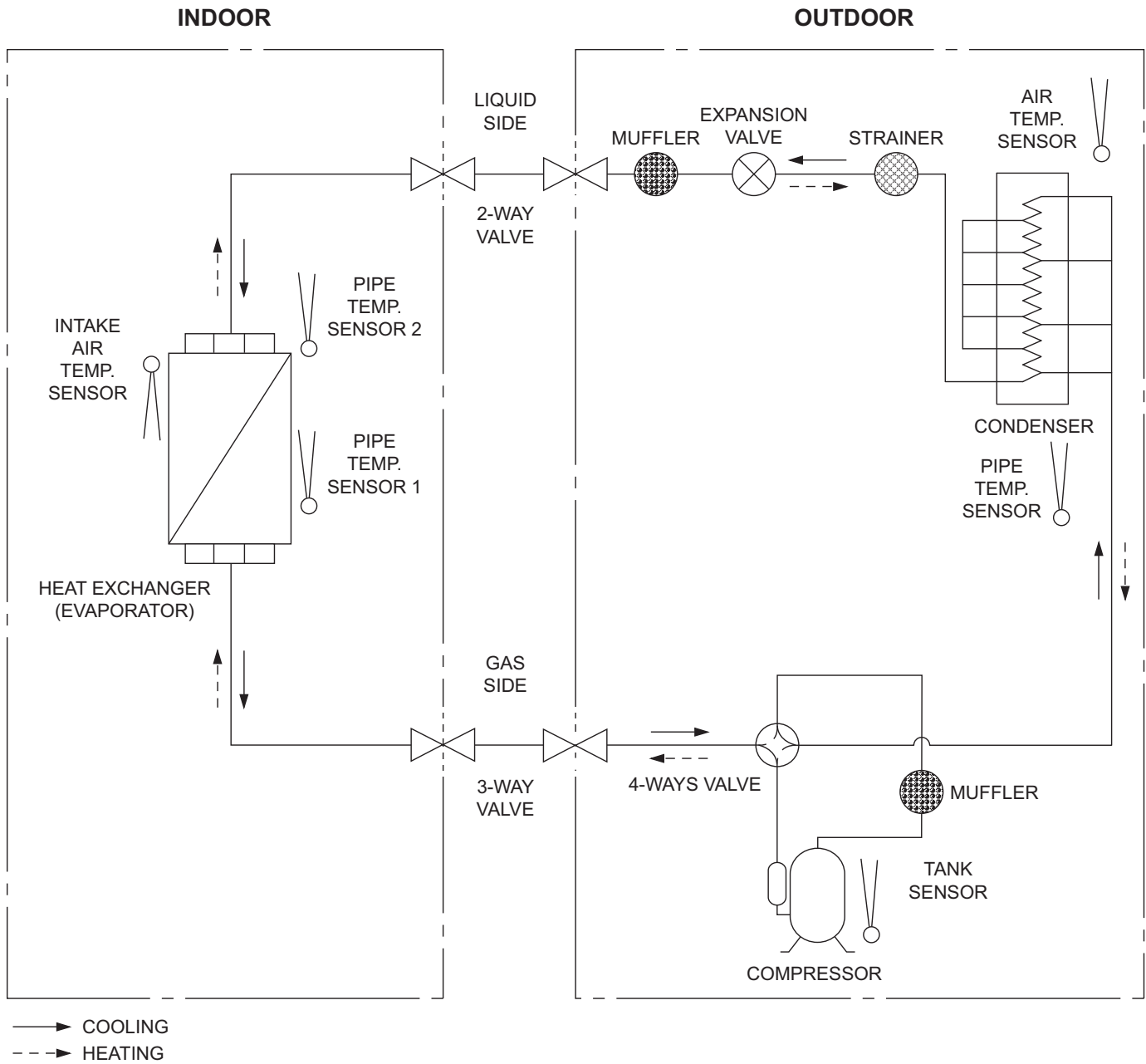

8. Block Diagram

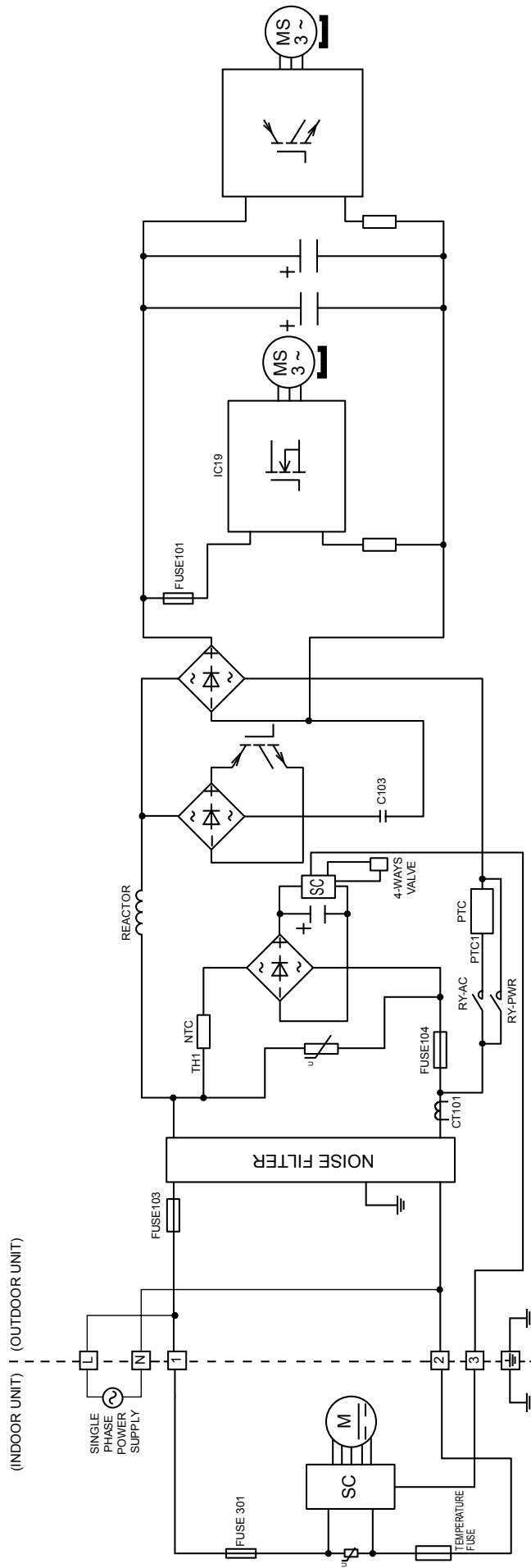

9. Wiring Connection Diagram

9.1 Indoor Unit

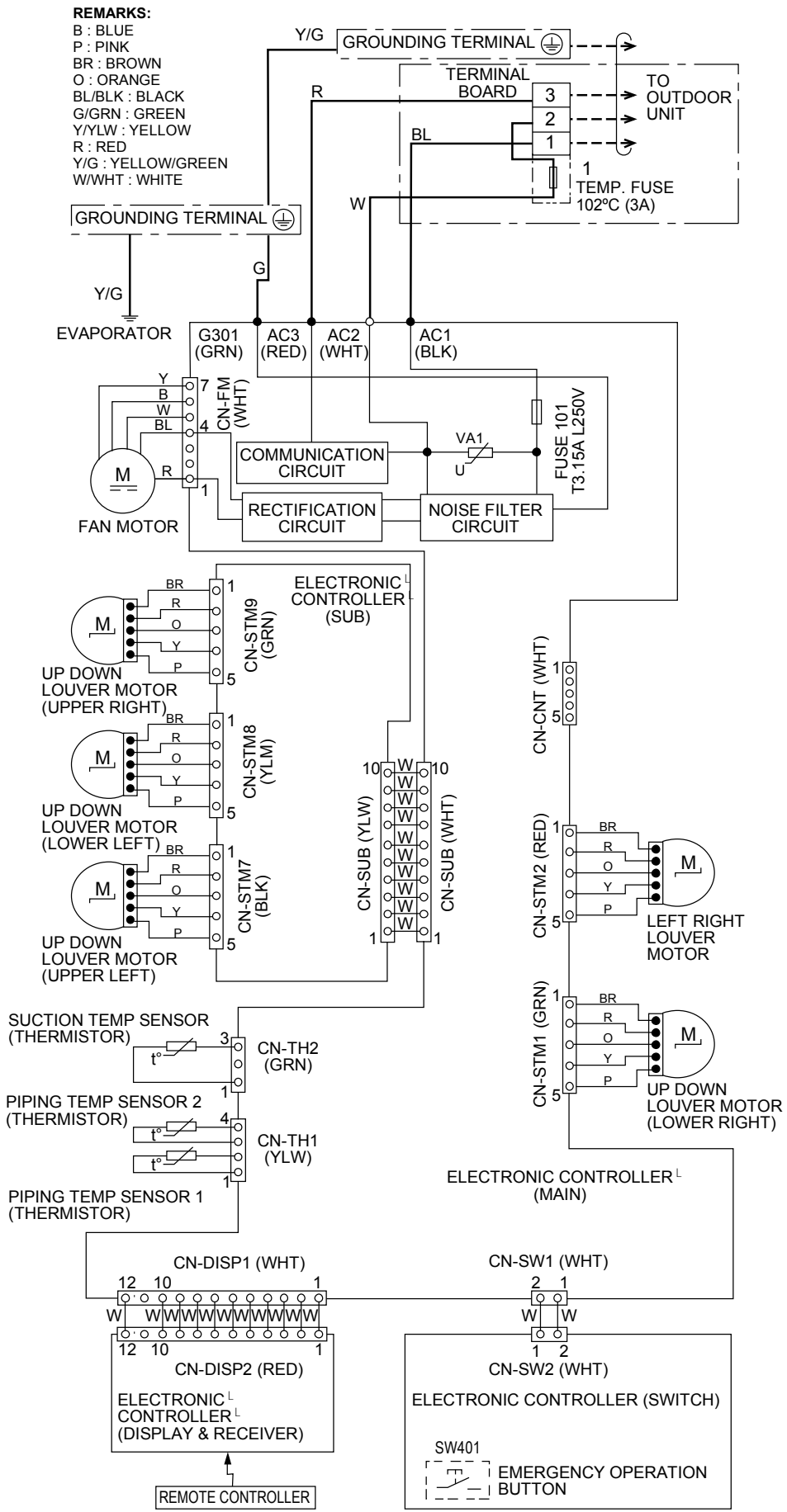

9.2 Outdoor Unit

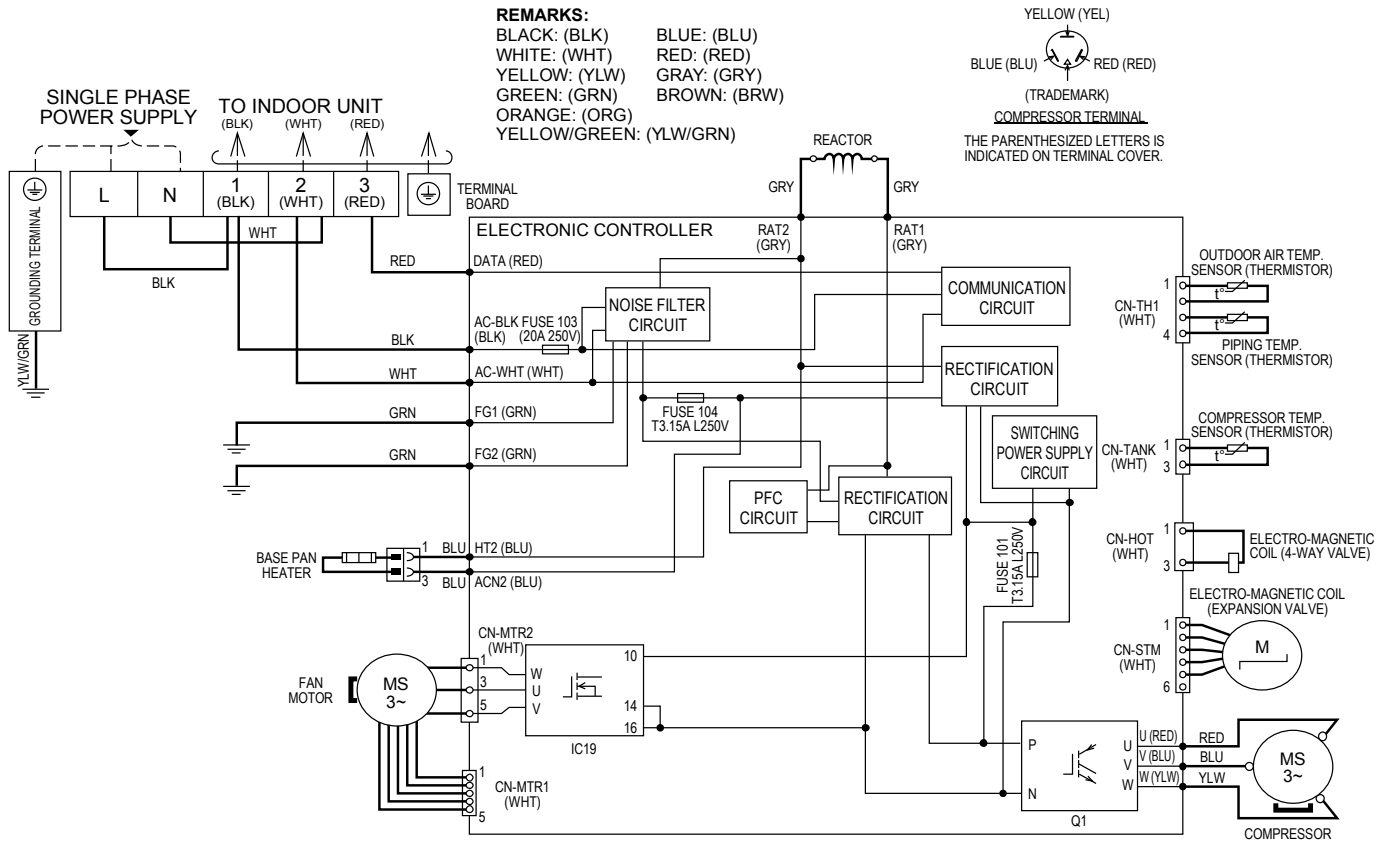

Resistance of Compressor Windings

MODEL	CU-LZ25TKE / CU-LZ35TKE
CONNECTION	9RD132XAB21 (Ω)
U-V	1.897
U-W	1.907
V-W	1.882

Note: Resistance at 20°C of ambient temperature.

10. Electronic Circuit Diagram

10.1 Indoor Unit

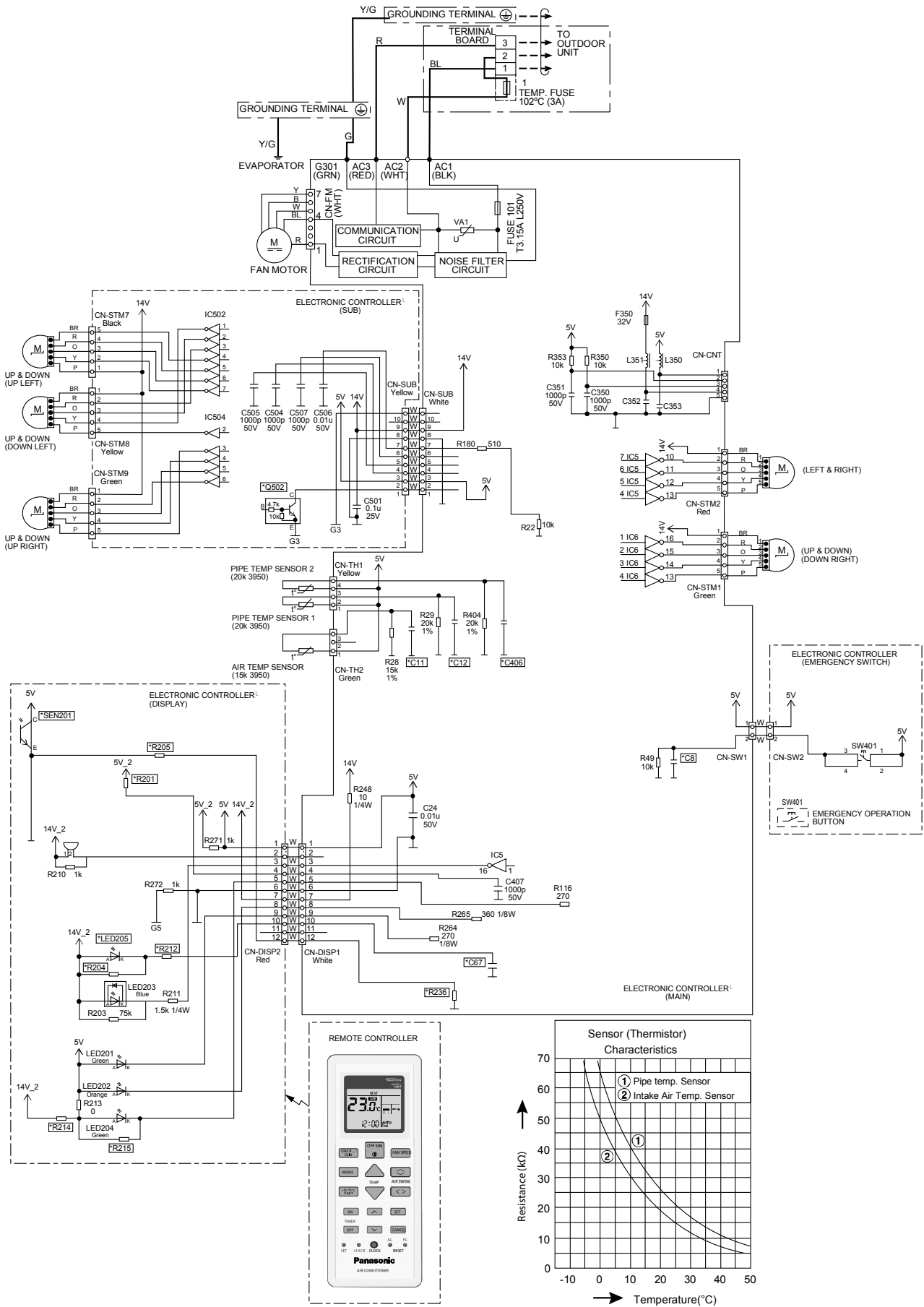

10.2 Outdoor Unit

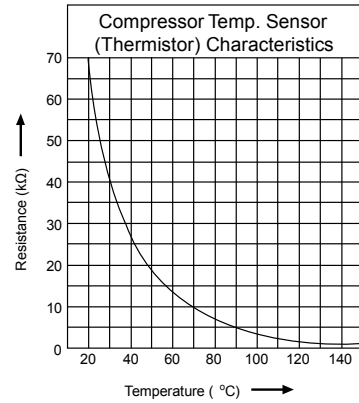
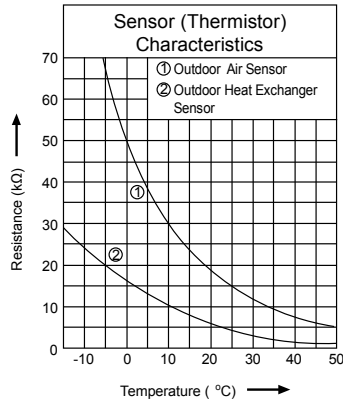
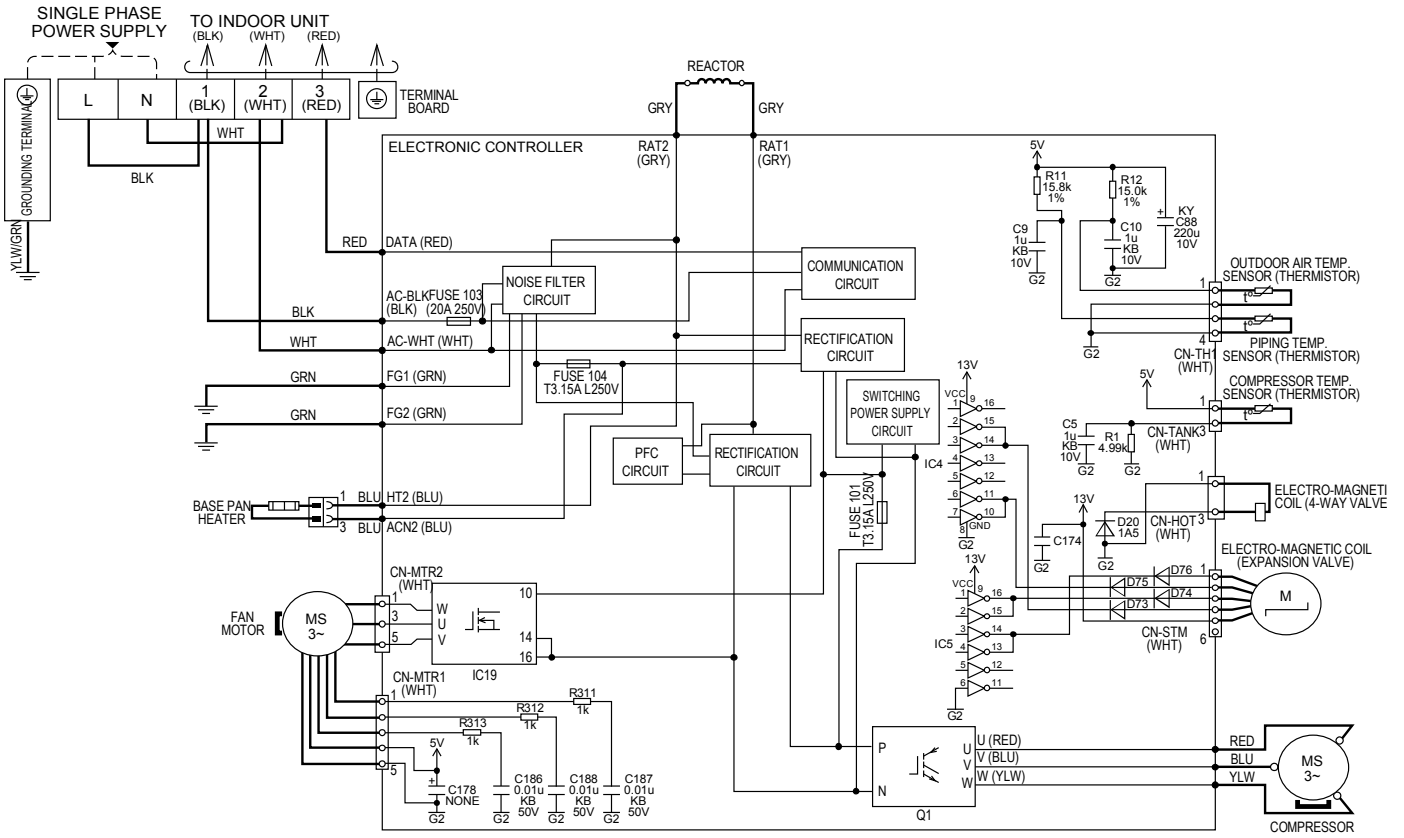

11. Printed Circuit Board

11.1 Indoor Unit

11.1.1 Main Printed Circuit Board

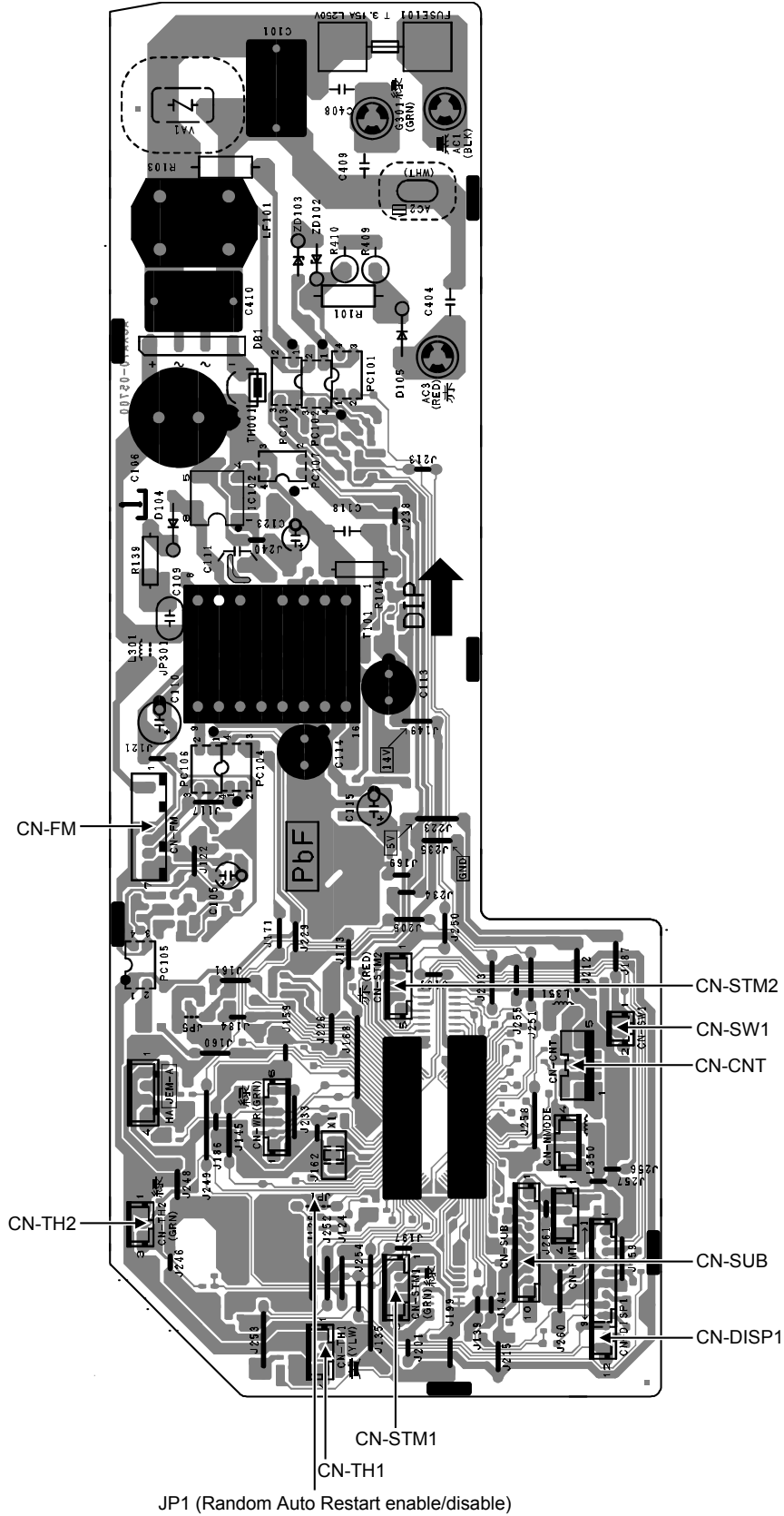

11.1.2 Indicator Printed Circuit Board

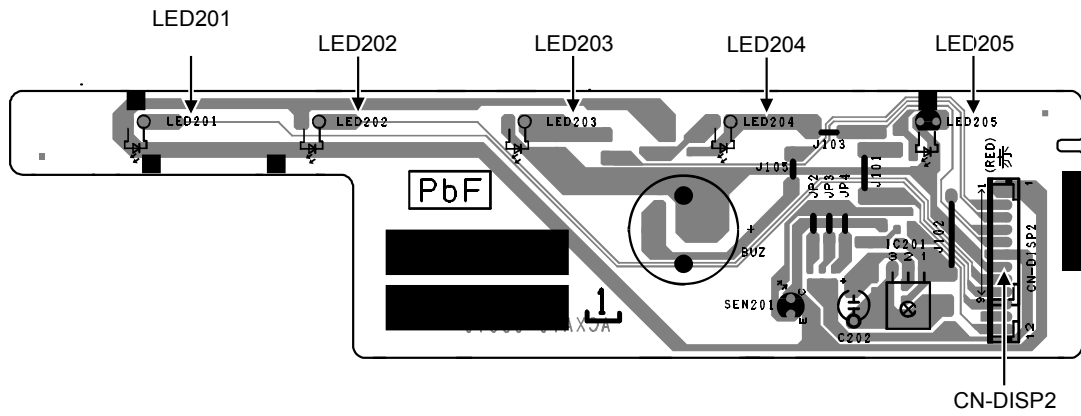

11.1.3 Switch Printed Circuit Board

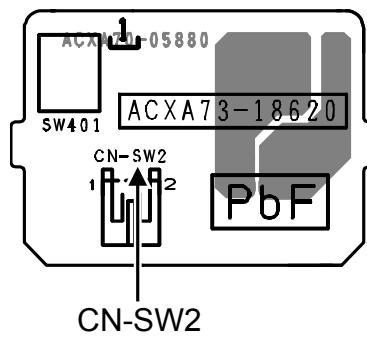

11.1.4 Sub Printed Circuit Board

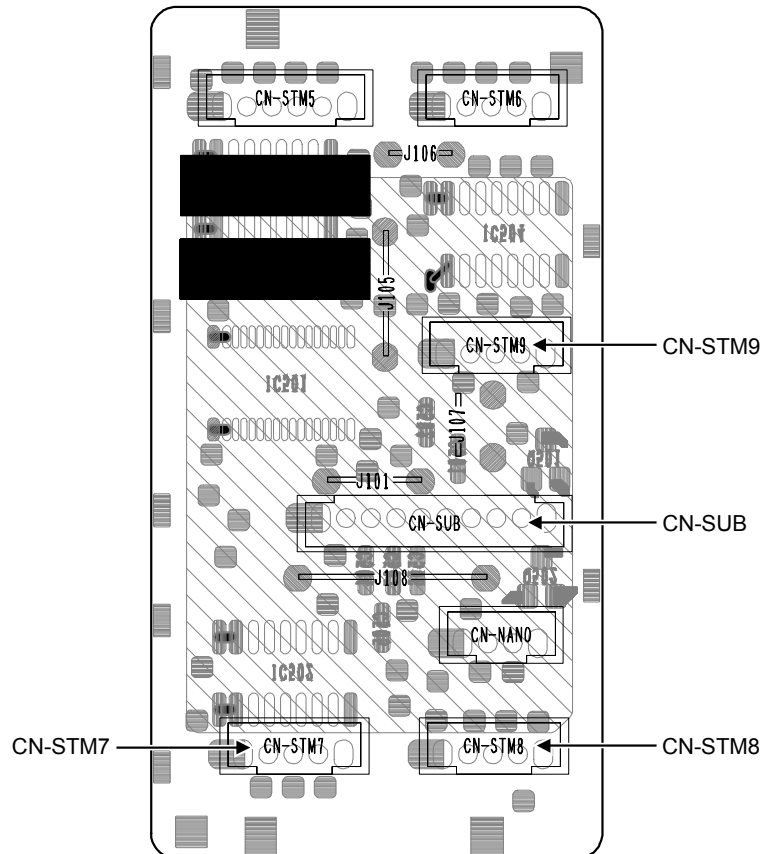

11.2 Outdoor Unit

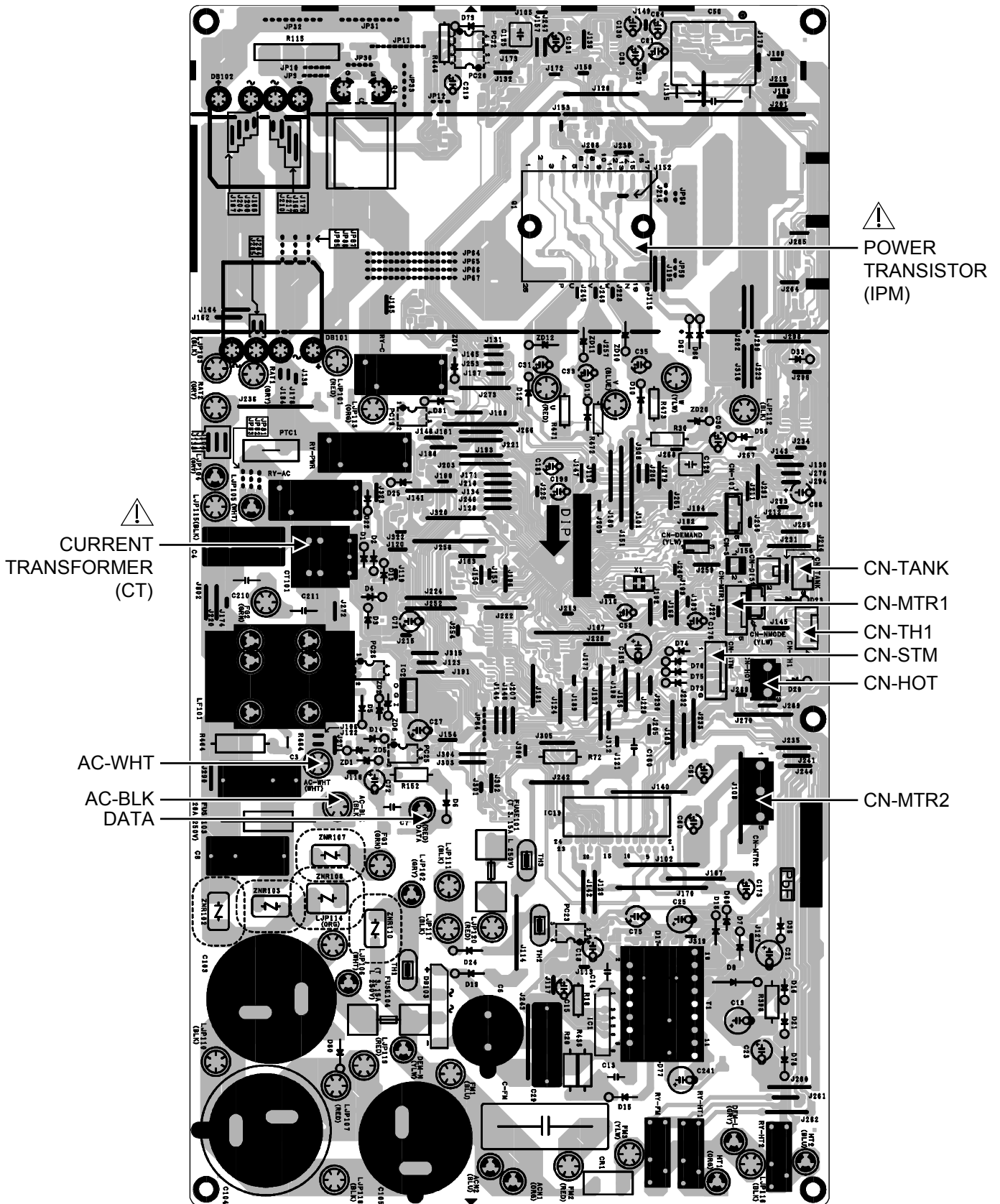

12. Installation Instruction

12.1 Select the Best Location

12.1.1 Indoor Unit

- Do not install the unit in excessive oil fume area such as kitchen, workshop and etc.
- There should not be any heat source or steam near the unit.
- There should not be any obstacles blocking the air circulation.
- A place where air circulation in the room is good.
- A place where drainage can be easily done.
- A place where noise prevention is taken into consideration.
- Do not install the unit near the door way.
- Ensure the spaces indicated by arrows from the wall, ceiling, fence or other obstacles.
- Installation height for indoor unit shall be at least 2.5 m.

12.1.2 Outdoor Unit

- If an awning is built over the unit to prevent direct sunlight or rain, be careful that heat radiation from the condenser is not obstructed.
- There should not be any animal or plant which could be affected by hot air discharged.
- Keep the spaces indicated by arrows from wall, ceiling, fence or other obstacles.
- Do not place any obstacles which may cause a short circuit of the discharged air.
- If piping length is over the [piping length for additional gas], additional refrigerant should be added as shown in the table.

Table A

Model	Horse Power (HP)	Piping size		Std. Length (m)	Max. Elevation (m)	Min. Piping Length (m)	Max. Piping Length (m)	Additional Refrigerant (g/m)	Piping Length for add. gas (m)	Indoor A _{min} (m ²)
		Gas	Liquid							
LZ25***	1.0HP	9.52mm (3/8")	6.35mm (1/4")	5	10	3	20	20	7.5	1.74
LZ35***	1.5HP									

Example: For LZ25***

If the unit is installed at 10 m distance, the quantity of additional refrigerant should be 50 g (10-7.5) m × 20 g/m = 50 g.

$$A_{\min} = (M / (2.5 \times (LFL)^{(5/4)} \times h_0))^2$$

A_{min} = Required minimum room area, in m²
M = Required charge amount in appliance, in kg
LFL = Lower flammable limit (0.306 kg/m³)
h₀ = Installation height of the appliance (1.8 m for wall mounted)

12.1.3 Indoor/Outdoor Unit Installation Diagram

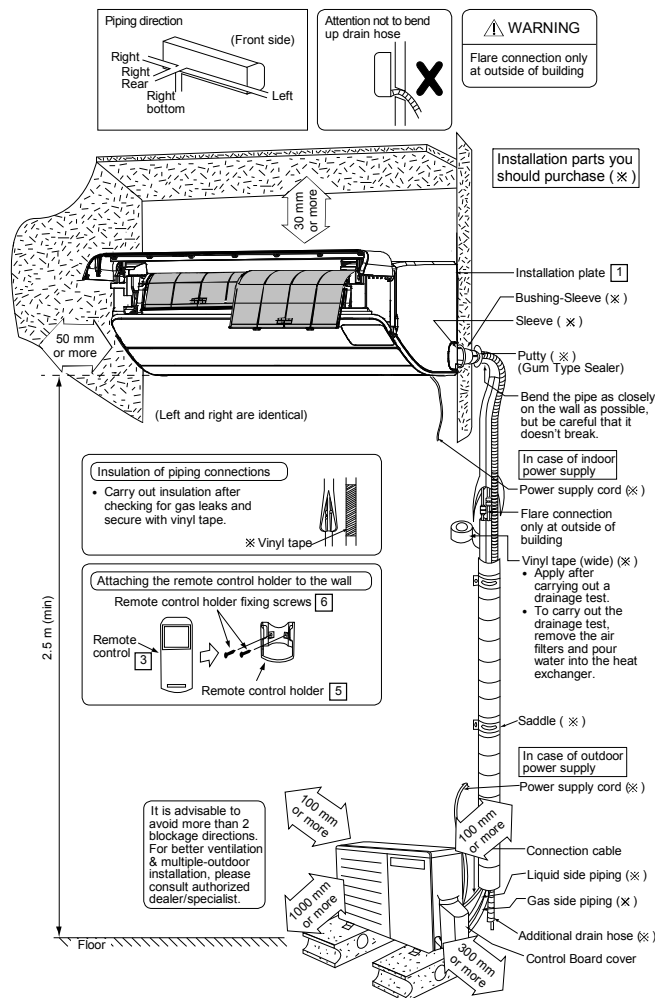

- This illustration is for explanation purposes only. The indoor unit will actually face a different way.

12.2 Indoor Unit

12.2.1 How to Fix Installation Plate

The mounting wall shall be strong and solid enough to prevent it from the vibration.

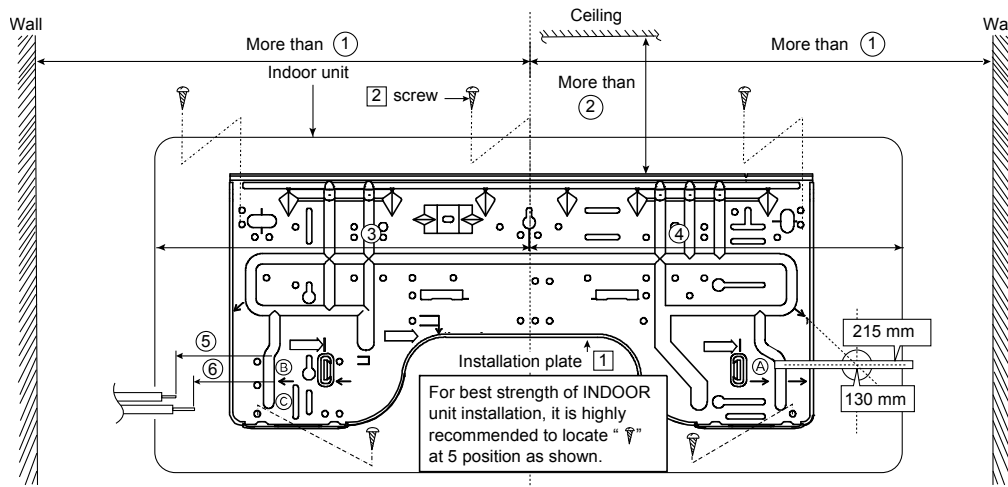

Model	Dimension					
	①	②	③	④	⑤	⑥
LZ25***, LZ35***	450 mm	52 mm	395 mm	395 mm	153 mm	93 mm

The center of installation plate should be at more than ① at right and left of the wall.

The distance from installation plate edge to ceiling should more than ②.

From installation plate center to unit's left side is ③.

From installation plate center to unit's right side is ④.

Ⓑ : For left side piping, piping connection for liquid should be about ⑤ from this line.

: For left side piping, piping connection for gas should be about ⑥ from this line.

- 1 Mount the installation plate on the wall with 5 screws or more (at least 5 screws).
(If mounting the unit on the concrete wall, consider using anchor bolts.)
 - Always mount the installation plate horizontally by aligning the marking-off line with the thread and using a level gauge.
- 2 Drill the piping plate hole with $\varnothing 70$ mm hole-core drill.
 - Line according to the left and right side of the installation plate.
The meeting point of the extended line is the center of the hole.
Another method is by putting measuring tape at position as shown in the diagram above.
The hole center is obtained by measuring the distance namely 130 mm for right hole.
 - Drill the piping hole at either the right or the left and the hole should be slightly slanting to the outdoor side.

12.2.2 To Drill a Hole in the Wall and Install a Sleeve of Piping

- 1 Insert the piping sleeve to the hole.
- 2 Fix the bushing to the sleeve.
- 3 Cut the sleeve until it extrudes about 15 mm from the wall.

CAUTION

⚠ When the wall is hollow, please be sure to use the sleeve for tube assembly to prevent dangers caused by mice biting the connection cable.

- 4 Finish by sealing the sleeve with putty or caulking compound at the final stage.

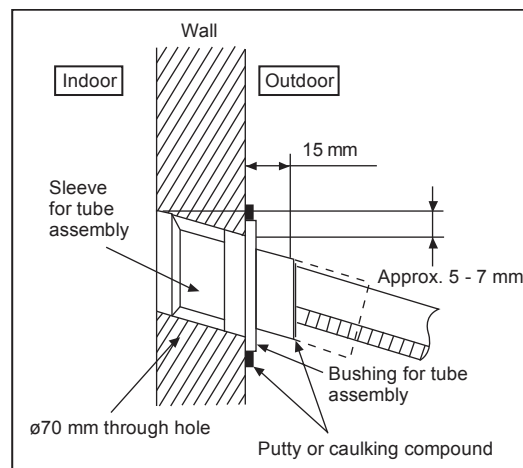

12.2.3 Indoor Unit Installation

- Turn the unit over as shown during pull out the piping.
- Do not turn over with front panel facing down, as it may cause front panel damage.

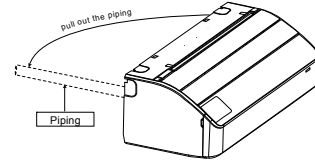
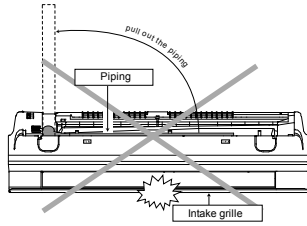

12.2.3.1 For the Right Rear Piping

Step-1 Pull out the Indoor piping

Step-2 Install the Indoor Unit

Step-3 Secure the Indoor Unit

Step-4 Insert the connection cable

12.2.3.2 For the Right and Right Bottom Piping

Step-1 Pull out the Indoor piping

Step-2 Install the Indoor Unit

Step-3 Insert the connection cable

Step-4 Secure the Indoor Unit

12.2.3.3 For the Embedded Piping

Step-1 Replace the drain hose

Step-2 Bend the embedded piping

- Use a spring bender or equivalent to bend the piping so that the piping is not crushed.

Step-3 Pull the connection cable into Indoor Unit

- The inside and outside connection cable can be connected without removing the front grille.

Step-4 Cut and flare the embedded piping

- When determining the dimensions of the piping, slide the unit all the way to the left on the installation plate.

Step-5 Install the Indoor Unit

Step-6 Connect the piping

- Please refer to "Connecting the piping" column in outdoor unit section. (Below steps are done after connecting the outdoor piping and gas-leakage confirmation.)

Step-7 Insulate and finish the piping

- Please refer to "Insulation of piping connection" column as mentioned in indoor/outdoor unit installation.

Step-8 Secure the Indoor Unit

Right Rear piping

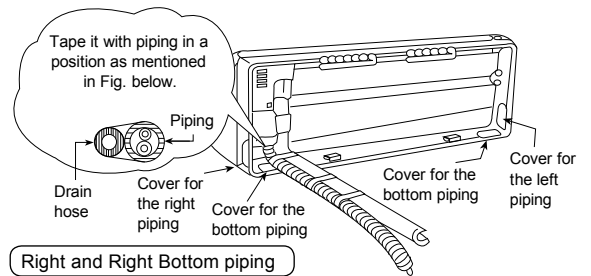

Right and Right Bottom piping

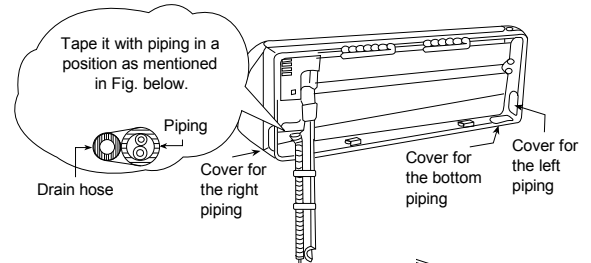

How to keep the cover

In case of the cover is cut, keep the cover at the rear of chassis as shown in the illustration for future reinstallation. (Left, right and 2 bottom covers for piping.)

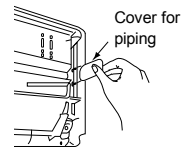

Install the indoor unit

Hook the indoor unit onto the upper portion of installation plate. (Engage the indoor unit with the upper edge of the installation plate). Ensure the hooks are properly seated on the installation plate by moving it in left and right.

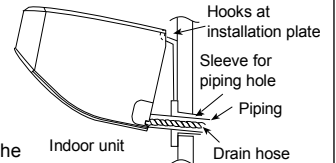

Secure the Indoor Unit

Press the lower left and right side of the unit against the installation plate until hooks engages with their slot (sound click).

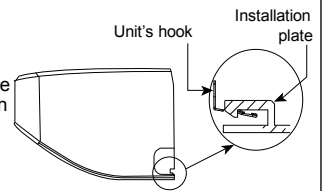

To take out the unit, push the **PUSH** marking at the bottom unit, and pull it slightly towards you to disengage the hooks from the unit.

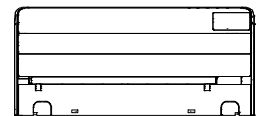

Insert the connection cable

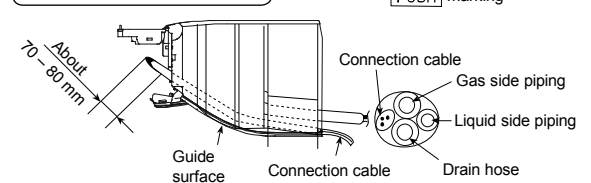

(This can be used for left piping also.)

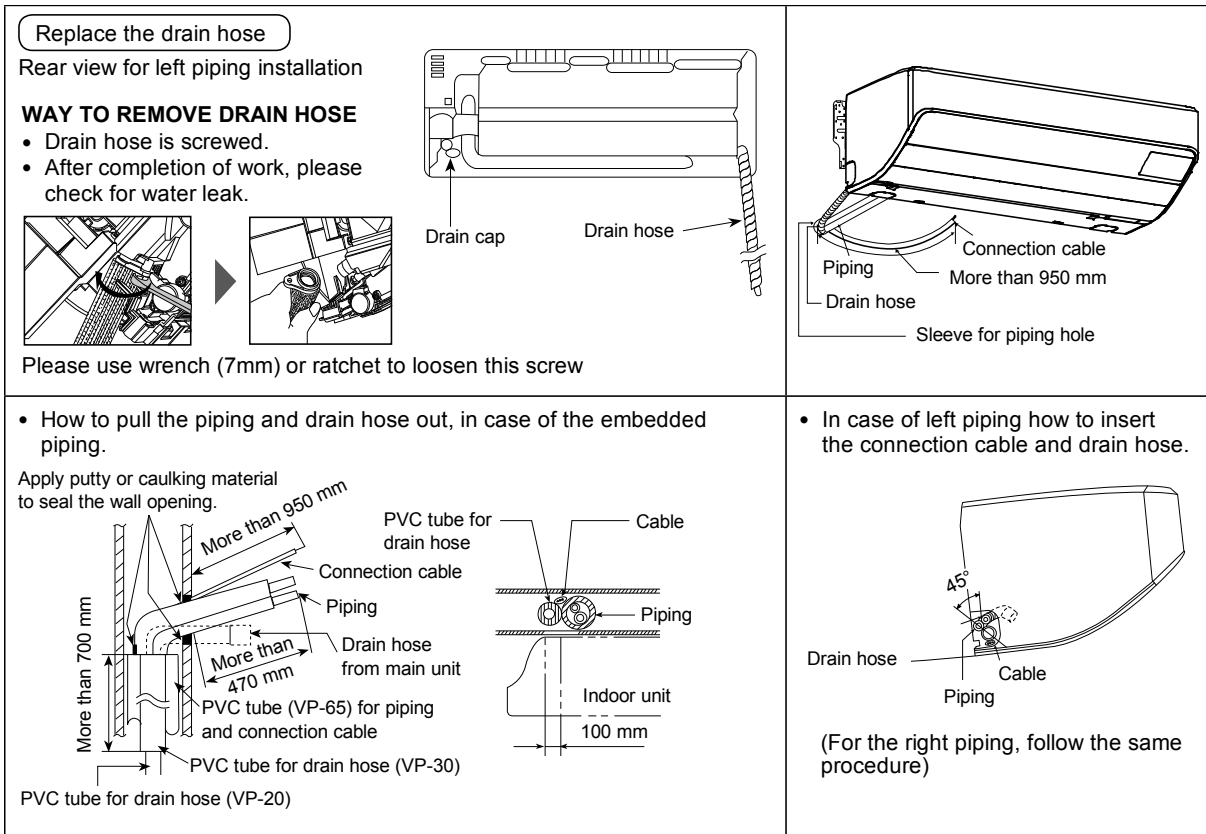

12.2.4 Connect the Cable to the Indoor Unit

- 1 The inside and outside connection cable can be connected without removing the front grille.
- 2 **Connection cable** between indoor unit and outdoor unit shall be approved polychloroprene sheathed $4 \times 1.5 \text{ mm}^2$ flexible cord, type designation 60245 IEC 57 or heavier cord. Do not use joint connection cable. Replace the wire if the existing wire (from concealed wiring, or otherwise) is too short. Allowable connection cable length of each indoor unit shall be 30 m or less.
- 3 Bind all the indoor and outdoor connection cable with tape and route the connection cable via the escapement.
- 4 Remove the tapes and connect the connection cable between indoor unit and outdoor unit according to the diagram below.

Terminals on the indoor unit	1	2	3	
Colour of wires				
Terminals on the outdoor unit	1	2	3	

Recommended length (mm)	a	b	c	d
	35	35	35	55

Recommended length (mm)

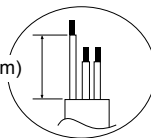

WARNING

This equipment must be properly earthed.

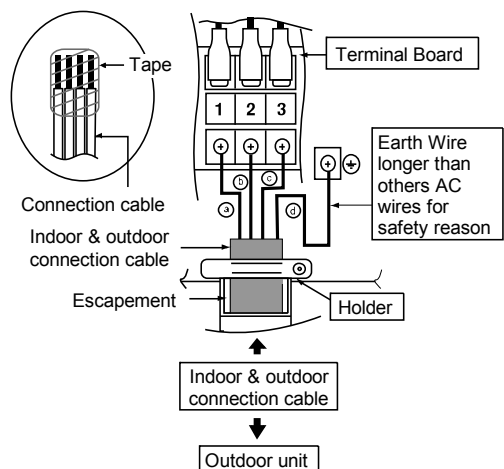

Note:

- Secure the connection cable onto the control board with the holder.
- Ensure the colour of wires of outdoor unit and the terminal Nos. are the same to the indoor's respectively.
- Earth wire shall be Yellow/Green (Y/G) in colour and longer than other AC wires for safety reason.

12.2.4.1 Wire Stripping, Connecting Requirement

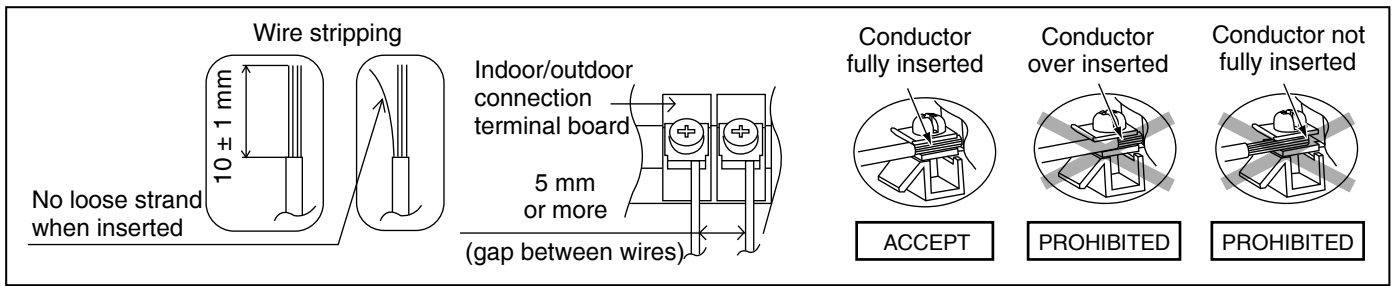

WARNING

RISK OF FIRE
JOINING OF WIRES MAY CAUSE OVERHEATING AND FIRE.

⊘ Do not joint wires.

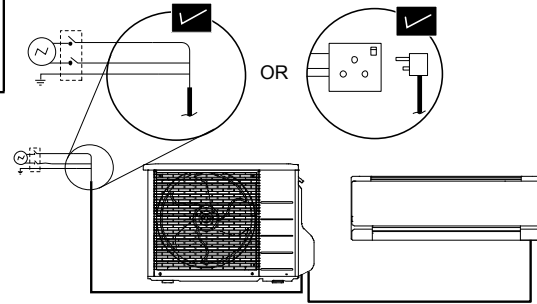
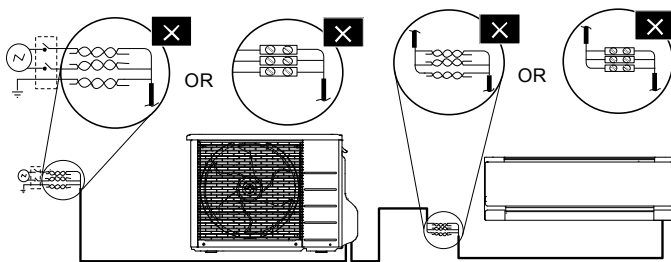

- ❗ Use complete wire without joining.
- ❗ Use approved socket and plug with earth pin.
- ❗ Wire connection in this area must follow to national wiring rules.

12.2.4.2 Cutting and flaring the piping

- 1 Please cut using pipe cutter and then remove the burrs.
- 2 Remove the burrs by using reamer. If burrs is not removed, gas leakage may be caused. Turn the piping end down to avoid the metal powder entering the pipe.
- 3 Please make flare after inserting the flare nut onto the copper pipes.

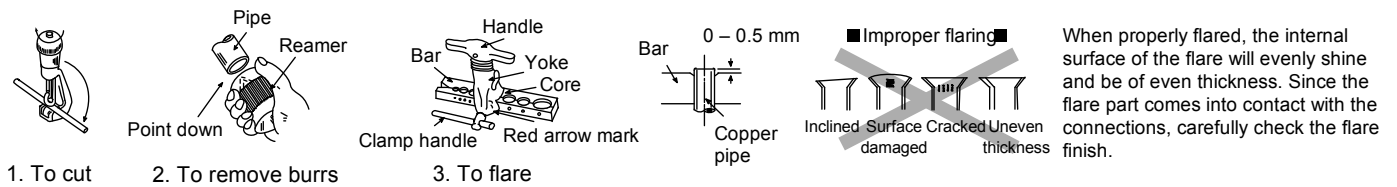

12.3 Outdoor Unit

12.3.1 Install the Outdoor Unit

- After selecting the best location, start installation to Indoor/Outdoor Unit Installation Diagram.
 - Fix the unit on concrete or rigid frame firmly and horizontally by bolt nut ($\phi 10$ mm).
 - When installing at roof, please consider strong wind and earthquake.
Please fasten the installation stand firmly with bolt or nails.

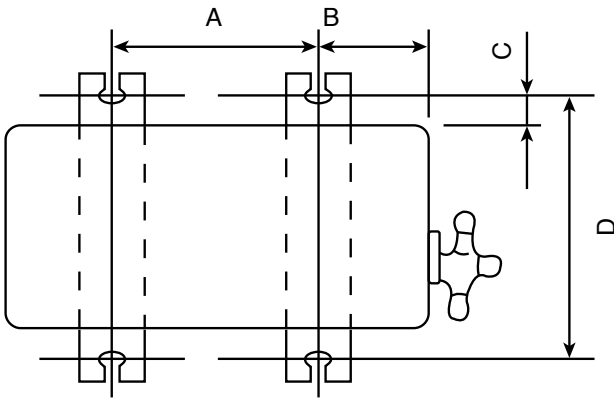

Model	A	B	C	D
LZ25***, LZ35***	540 mm	160 mm	18.5 mm	330 mm

12.3.2 Connect the Piping

12.3.2.1 Connecting the Piping to Indoor

For connection joint location at outside building
Please make flare after inserting flare nut (locate at joint portion of tube assembly) onto the copper pipe.
(In case of using long piping)

Connect the piping

- Align the center of piping and sufficiently tighten the flare nut with fingers.
- Further tighten the flare nut with torque wrench in specified torque as stated in the table.

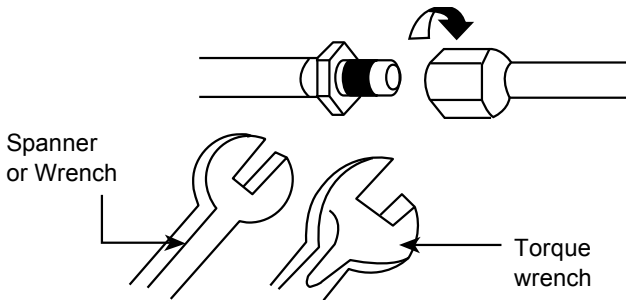

For connection joint location at inside building

- Decide the length.
- Cut and remove the tube connectors at indoor copper pipings (both gas and liquid piping) by using pipe cutter. Remove burrs from cut edge.
- Use pipe expander to expand the end of long piping.
- Align the center of piping and braze the piping joints.

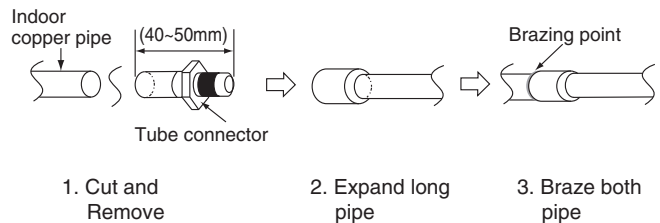

- Cut and Remove
- Expand long pipe
- Braze both pipe

12.3.2.2 Connecting the Piping to Outdoor

Decide piping length and then cut by using pipe cutter. Remove burrs from cut edge.



Make flare after inserting the flare nut (locate at valve) onto the copper pipe.

Align center of piping to valve and then tighten with torque wrench to the specified torque as stated in the table.

Do not overtighten, overtightening may cause gas leakage.	
Piping size	Torque
6.35 mm (1/4")	[18 N•m (1.8 kgf•m)]
9.52 mm (3/8")	[42 N•m (4.3 kgf•m)]
12.7 mm (1/2")	[55 N•m (5.6 kgf•m)]
15.88 mm (5/8")	[65 N•m (6.6 kgf•m)]
19.05 mm (3/4")	[100 N•m (10.2 kgf•m)]

12.3.3 Evacuation of the Equipment

WHEN INSTALLING AN AIR CONDITIONER, BE SURE TO EVACUATE THE AIR INSIDE THE INDOOR UNIT AND PIPES in the following procedure.

	Do not purge the air with refrigerants but use a vacuum pump to vacuum the installation.
	There is no extra refrigerant in the outdoor unit for air purging.

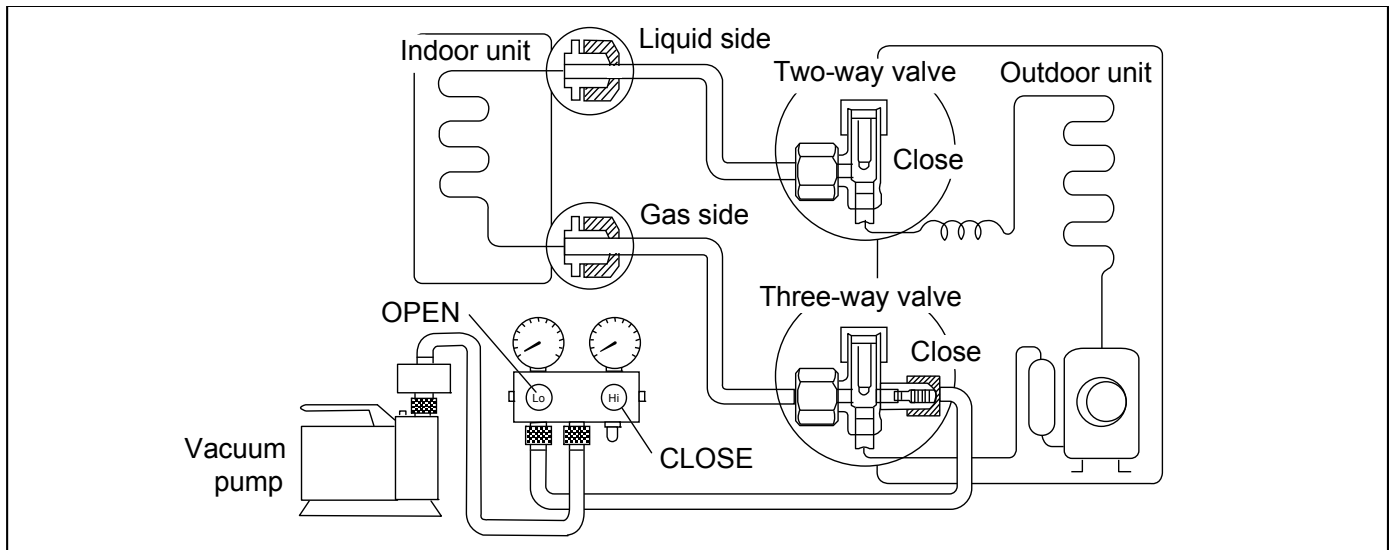

- 1 Connect a charging hose with a push pin to the Low side of a charging set and the service port of the 3-way valve.
 - Be sure to connect the end of the charging hose with the push pin to the service port.
- 2 Connect the center hose of the charging set to a vacuum pump.
- 3 Turn on the power switch of the vacuum pump and make sure that the needle in the gauge moves from 0 cmHg (0 MPa) to -76 cmHg (-0.1 MPa). Then evacuate the air approximately ten minutes.
- 4 Close the Low side valve of the charging set and turn off the vacuum pump. Make sure that the needle in the gauge does not move after approximately five minutes.

Note: BE SURE TO TAKE THIS PROCEDURE IN ORDER TO AVOID REFRIGERANT GAS LEAKAGE.
- 5 Disconnect the charging hose from the vacuum pump and from the service port of the 3-way valve.
- 6 Tighten the service port caps of the 3-way valve at a torque of 18 N•m with a torque wrench.
- 7 Remove the valve caps of both of the 2-way valve and 3-way valve. Position both of the valves to “OPEN” using a hexagonal wrench (4 mm).
- 8 Mount valve caps onto the 2-way valve and the 3-way valve.
 - Be sure to check for gas leakage.

<ul style="list-style-type: none"> • If gauge needle does not move from 0 cmHg (0 MPa) to -76 cmHg (-0.1 MPa), in step ③ above take the following measure: <ul style="list-style-type: none"> - If the leak stops when the piping connections are tightened further, continue working from step ③. - If the leak does not stop when the connections are retightened, repair location of leak. - Do not release refrigerant during piping work for installation and reinstallation. - Take care of the liquid refrigerant, it may cause frostbite.

12.3.4 Connect the Cable to the Outdoor Unit

- 1 Remove the control board cover from the unit by loosening the screw.
- 2 Cable connection to the power supply through Isolating Devices (Disconnecting means).
 - Connect approved type polychloroprene sheathed **power supply cord** 3 × 1.5 mm² type designation 60245 IEC 57 or heavier cord to the terminal board, and connect the others end of the cord to Isolating Devices (Disconnecting means).
 - Do not use joint power supply cord. Replace the wire if the existing wire (from concealed wiring, or otherwise) is too short.
 - In unavoidable case, joining of power supply cord between isolating devices and terminal board of air conditioner shall be done by using approved socket and plug with earth pin rated 15/16A. Wiring work to both socket and plug must follow to national wiring standard.
- 3 **Connection cable** between indoor unit and outdoor unit shall be approved polychloroprene sheathed 4 × 1.5 mm² flexible cord, type designation 60245 IEC 57 or heavier cord. Do not use joint connection cable. Replace the wire if the existing wire (from concealed wiring, or otherwise) is too short. Allowable connection cable length of each indoor unit shall be 30 m or less.
- 4 Connect the power supply cord and connection cable between indoor unit and outdoor unit according to the diagram below.

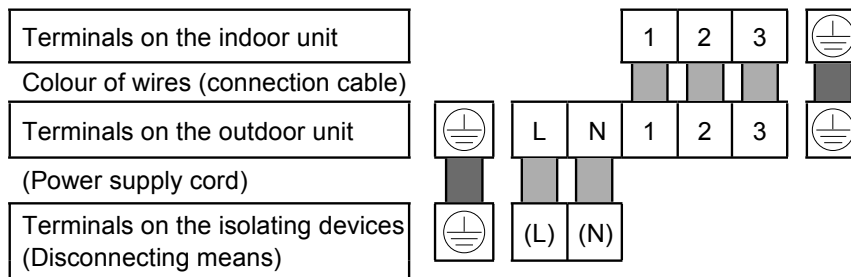

- 5 Secure the power supply cord and connection cable onto the control board with the holder.
- 6 Attach the control board cover back to the original position with screw.
- 7 For wire stripping and connection requirement, refer to instruction ⑤ of indoor unit.

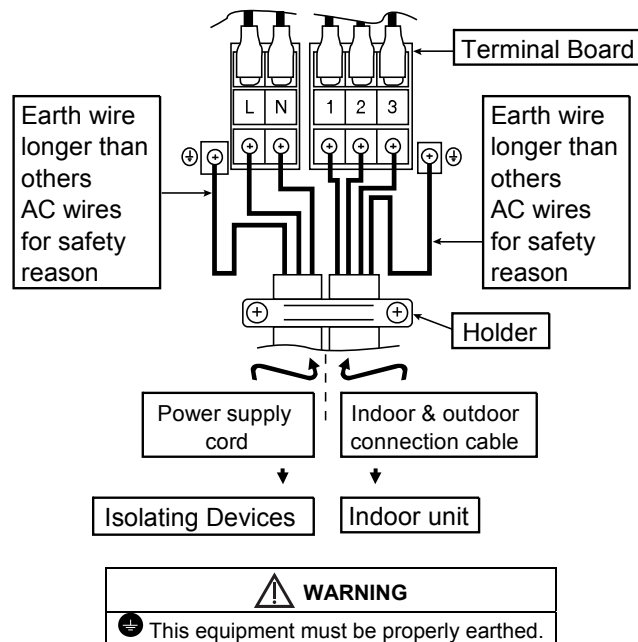

- Note: Isolating Devices (Disconnecting means) should have minimum 3.0 mm contact gap.
- Earth wire shall be Yellow/Green (Y/G) in colour and longer than other AC wires for safety reason.

12.3.5 Piping Insulation

- 1 Please carry out insulation at pipe connection portion as mentioned in Indoor/Outdoor Unit Installation Diagram. Please wrap the insulated piping end to prevent water from going inside the piping.
- 2 If drain hose or connecting piping is in the room (where dew may form), please increase the insulation by using POLY-E FOAM with thickness 6 mm or above.

12.3.6 How to Remove Bottom Plate

When perform left piping, remove the bottom plate.

To remove bottom plate:

Pull the left & right caps down, then remove screws. Holding around screw area, pull the part downward & forward.

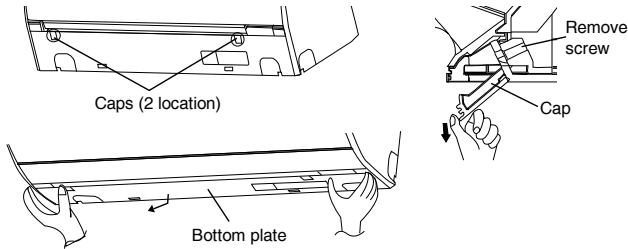

To fix back bottom plate:

Plate the hook of bottom plate into matching holes. Push up & back into position.

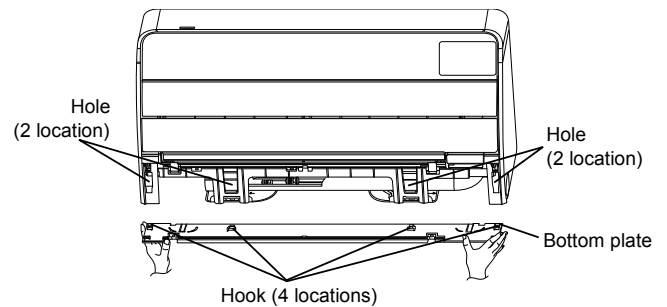

12.3.7 How to Remove Front Grille (Right)

Please follow below steps to take out front grille (right) if necessary such as when servicing. (refer illustration at right)

- 1 Remove front panel. (turn open by two hand, push to side, then pull forward)
- 2 Turn down the upper vane & lower vane.
- 3 Open the display panel by holding on left & right side & turn down.
- 4 Remove 2 screws and release top hook to take out front grille.

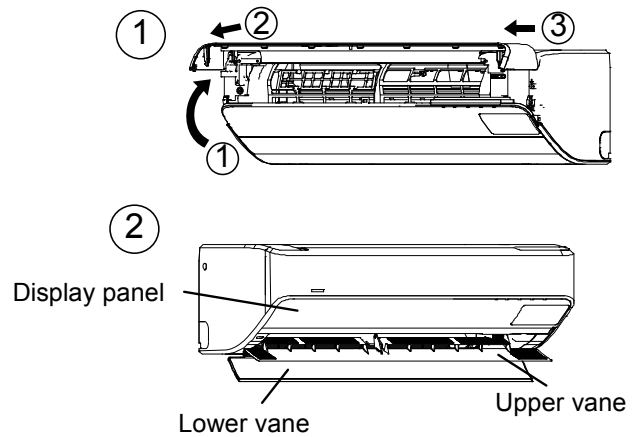
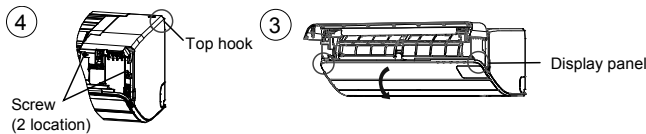

12.3.8 Auto Switch Operation

The below operations will be performed by pressing the "AUTO" switch.

- 1 **AUTO OPERATION MODE**
The Auto operation will be activated immediately once the Auto Switch is pressed and release before 5 sec..
- 2 **TEST RUN OPERATION (FOR PUMP DOWN/SERVICING PURPOSE)**
The Test Run operation will be activated if the Auto Switch is pressed continuously for more than 5 sec. to below 8 sec..
A "pep" sound will occur at the fifth sec., in order to identify the starting of Test Run operation.
- 3 **HEATING TRIAL OPERATION**
Press the "AUTO" switch continuously for more than 8 sec. to below 11 sec. and release when a "pep pep" sound is occurred at eight sec. (However, a "pep" sound is occurred at fifth sec..) then press Remote controller "A/C Reset" button once.
Remote controller signal will activate operation to force heating mode.
- 4 **REMOTE CONTROLLER RECEIVING SOUND ON/OFF**
The ON/OFF of Remote controller receiving sound can be change over by the following steps:
 - a) Press "AUTO" switch continuously for more than 16 sec. to below 21 sec..
A "pep", "pep", "pep", "pep" sound will occur at the sixteenth sec..
 - b) Press the "A/C Reset" button once. Remote controller signal will activate the Remote controller sound setting mode.
 - c) Press the "AUTO" switch once to select Remote controller receiving sound ON/OFF. A "peep" sound indicates receiving sound ON, and a "pep" sound indicates receiving sound OFF.
- 5 **HEATING ONLY OPERATION**
Press the "AUTO" switch continuously for more than 8 sec. to below 11 sec. And release when a "pep pep" sound is occurred at eighth sec.
(However, a "pep" sound is occurred at fifth sec.) Then press Remote controller "Check" button once. Remote controller signal will activate heating only operation mode.

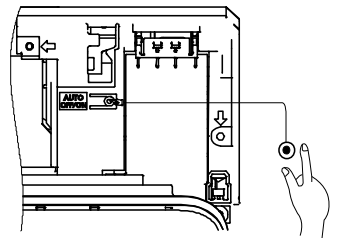

12.3.9 Outdoor Unit Drain Water

- Water will drip from the basepan hole area during defrost function.
- To avoid water dripping, do not stand or place objects at this area.

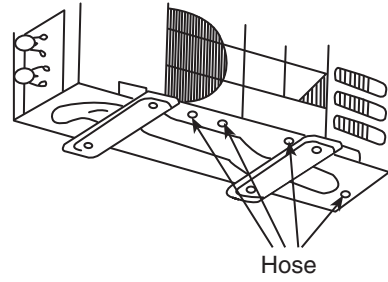

12.3.10 Check the Drainage

- Open front panel and remove air filters. (Drainage checking can be carried out without removing the front grille.)
- Pour a glass of water into the drain tray-styrofoam.
- Ensure that water flows out from drain hose of the indoor unit.

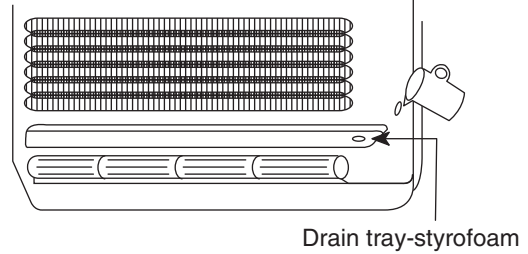

12.3.11 Evaluation of the Performance

- Operate the unit at cooling/heating operation mode for fifteen minutes or more.
- Measure the temperature of the intake and discharge air.
- Ensure the difference between the intake temperature and the discharge is more than 8°C during Cooling operation or more than 14°C during Heating operation.

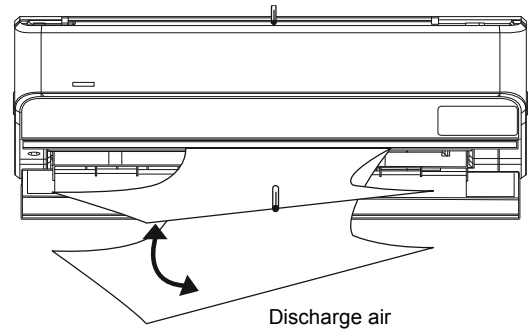

13. Installation and Servicing Air Conditioner using R32

13.1 About R32 Refrigerant

For air conditioning refrigerants such as R410A, the refrigerants were collected back in order to prevent their air dissipation, to curbe the global warming impact, in case they were released into the atmosphere. In the “4th Environmental Basic Plan”, 80% reduction of greenhouse gas emissions by 2050 is required, and due to this requirement, further reduction in the emission of high greenhouse effect gas, such as CFCs, is required. Therefore, the conversion of air conditioning refrigerant into the ones who has smaller greenhouse effect, even if it is dissipated into the atmosphere, became our responsibility.

Nevertheless, in case of air conditioning refrigerant, it would be the best if there is a refrigerant which has smaller impact on global warming, but ensures good energy efficiency and performance, and is safe; however, there is no such refrigerant which satisfies all these conditions. As a result, we have been considering the practical usage, within the safety frame-work, of R32 refrigerant which has short lifetime in the atmosphere, and has smaller effect of global warming, but is slightly flammable.

In 2004, due to the revision of air conditioner safety standards by the International Electro-safety Commission (IEC), the safety standards of air conditioners using slightly flammable refrigerant was issued. In 2010, the regulations of American Society of Heating, Refrigerating and Air-Conditioning Engineers in the United States (ANSI/ASHRAE34) was issued adopting the grades for refrigerants which are difficult to inflame due to their slow burning rates, and as a result have smaller damages in cases of fire. The burning rate of R32 is lower by 10cm / per second, and safety standardization for various usage is now being processed.

13.2 Characteristics of R32 Refrigerant

1. Chemical Characteristics

R32 is one of the refrigerants used in R410A, has almost no toxicity, and chemically stable compound formed by hydrogen, carbon and fluorine.

R32 has short lifetime of 4 to 9 years in case of being released into the atmosphere; therefore, it has smaller greenhouse gas effect but has slight inflammability because of the large proportion of hydrogen.

Chemical Characteristic Table of R32, R410A and R22.

	R32	R410A	R22
Chemical Formula	CH ₂ F ₂	CH ₂ F ₂ / CHF ₂ CF ₃	CH ₂ ClF ₂
Composition (mixture ratio wt.%)	Single Composition	R32 / R125A (50 / 50 wt.%)	Single Composition
Boiling Point (°C)	-51.7	-51.5	-40.8
Pressure (physical) *1	3.14	3.07	1.94
Capacity (physical) *2	160	141	100
COP (physical) *3	95	91	100
Ozone Depletion Potential (ODP)	0	0	0.055
Global Warming Potential (GWP) *4	675	2090	1810
Inflammability *5	Slightly Inflammable (A2L)	Non-inflammable (A1)	Non-inflammable (A1)
Toxicity	None	None	None

*1 : Physical property of temperature condition 50°C

*2 : Relative value of temperature condition 0/50°C, providing R22=100

*3 : Te/Tc/SC/SH=5/50/3/0°C

*4 : GWP=Global Warming Potential, each figure is based on “4th IPCC4 Report”

*5 : Based on ANSI / ASHRAE std. 34-2010

2. Characteristic of Pressure

As shown in Table 2, R32 does not have much difference in vapor pressure at the same refrigerant temperature comparing to R410A, but comparing to R22, it is higher at 1.6 times more. Thus, the same as in case of R410A, it is necessary to do installation and service using high-pressure tools and components.

Table 2. Saturated vapor pressure comparison table

(Unit: MPa)

Temperature	Refrigerant		
	R32	R410A	R22
-20	0.30	0.30	0.14
0	0.71	0.70	0.40
20	1.37	1.35	0.81
40	2.38	2.32	1.43
60	3.84	3.73	2.33
65	4.29	4.17	2.60

Reference : Thermal properties table of Japan Society of Refrigerating and Air Conditioning Engineers (60, 65°C)
NIST REFPROP V8.0 (-20 ~ 40°C)

13.3 Refrigerant piping installation • Tools used in services

13.3.1 Required Tools

R32 refrigerant air conditioners use the common parts as R410A air conditioners for two-way valves and three-way valves (diameters of service ports); thus, they maintain commonality in the maintenance of the compressive strength, the size of pipe flaring, and the size of flare nuts as R410A. Therefore, for refrigerant pipe installation and services, you can use tools for R410A.

However, mixing of refrigerants is not allowed, so that you have to separate the cylinders for the recovery of refrigerants.

Tools used for installation • relocation • replacement of air conditioning units

Works	R32	R410A	R22
Flaring	Flare tools for R410A (clutch type)		Flare tools for R22 (clutch type)
Connection of pipes	Torque wrench (diameter 1/4 3/8)		
	Torque wrench (diameter 1/2 5/8) *1		Toque wrench (diameter 1/2 5/8)
Manifold gauge charging hose	R32 & R410A Common (As at November 2013)		R22 Only
Air purging	Vacuum pump + Reducer / expander		Vacuum pump
Gas leakage test	Detection liquid or soup water, HFC detector		

*1. Nut diameters of 1/2 5/8, the size of torque wrench common with R410A

For other installation, you can use general tools such as screw drivers (+, -), metal saws, electric drills, long-nose pliers, hole core drills (ø70 or ø65), linen tape, levels, temperature gauges, clamp meters, electric knives, nippers, pipe cutters, reamers or scrapers, spring benders, (diameters 1/4 3/8 1/2 5/8), monkey wrenches, fixing wrenches (17 or 12 mm), feeler gauges, hexagon wrenches (4 mm), testers, megohm testers, etc.

Tools used for services

Works	R32	R410A	R22
Insertion of refrigerant	Digital scale for refrigerant charging, refrigerant cylinders, cylinder adopters and packing *a		
Recovery of refrigerant	Refrigerant recovery devices, refrigerant cylinders, manifold gauges, charging hoses *b		

*a. Use cylinder for each refrigerant, cylinder adopter and packing.

*b. Use refrigerant recovery cylinder separately for each refrigerant (**no mixture of refrigerant allowed**). Please be aware that there are some refrigerant collection devices which do not have self-certification.

13.3.2 Tools for R32 (common with R410A)

1. Flare gauges

Use flare gauges when you perform flaring with flare tools (crutch type). Flare gauges are used to set the pipe ends at 0.5 ~ 1.5 mm from clump bars of flare tools.

Flare gauges



2. Flare tools (clutch type)

Flare tools have larger holes of clump bars in order to set the pipe end at 0 ~ 0.5 mm, and have stronger springs inside to ensure solid flaring torques. These flare tools can be used commonly for R22.

Flare tools (clutch type)



3. Torque wrenches (diameters 1/2, 5/8)

In order to strengthen the compressive strength, the diameters of wrenches change depending on the flare nut sizes.

Torque wrenches

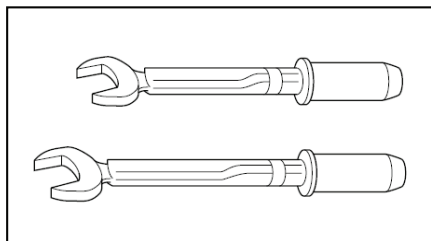

Differences in torque wrenches

	R32 (common R410A)	R22
1/2 (diameter × torque)	26 mm × 55 N•m (550 kgf•m)	24 mm × 55 N•m (550 kgf•m)
5/8 (diameter × torque)	29 mm × 65 N•m (650 kgf•m)	27 mm × 65 N•m (650 kgf•m)

4. Manifold gauges

R22 gauges cannot be used because of the high pressures.

Each port of manifold has different shapes in order to prevent inserting wrong refrigerant.

*However, the port shape for R410A and R32 is the same; therefore, attention need to be paid not to insert wrong refrigerant.

Differences in high/low pressure gauges

	R32 (common R410A)	R22
High pressure gauges (red)	-0.1 ~ 5.3 MPa -76 cmHg ~ 53 kgf / cm ²	-76 cmHg ~ 35 kgf / cm ²
Low pressure gauges (blue)	-0.1 ~ 3.8 MPa -76 cmHg ~ 38 kgf / cm ²	-76 cmHg ~ 17 kgf / cm ²

Difference in manifold port sizes

	R32 (common R410A)	R22
Port sizes	1/2 UNF20	7/16 UNF20

5. Charging hoses

The pressure resistance of charge hoses is increased. At the same time, the material is changed to HFC resistant, and the size of each manifold adopter is changed, as the port size of manifold gauge itself. Further, some hoses are with anti-gas pressure backflow valves placed near the adopters. (hoses with the valves recommended)

Manifold gauges / Charging hoses



Differences in charging hoses

		R32 (common R410A)	R22
Pressure Resistance	Normal operation pressure	5.1 MPa (52 kgf / cm ²)	3.4 MPa (35 kgf / cm ²)
	Burst pressure	27.4 MPa (280 kgf / cm ²)	17.2 MPa (175 kgf / cm ²)
Material		HNBR rubber Internal nylon coating	NBR rubber

6. Vacuum pump and Vacuum pump adopter

When using a vacuum pump, it is necessary to set a solenoid valve in order to prevent backflow of vacuum pump oil into the charge hoses, and use a vacuum pump with oil backflow prevention function, or use the vacuum pump with vacuum pump adopter.

If vacuum pump oil (mineral oil-based) mixes with R410A (R32), it may cause damage to the machine.

Vacuum pump

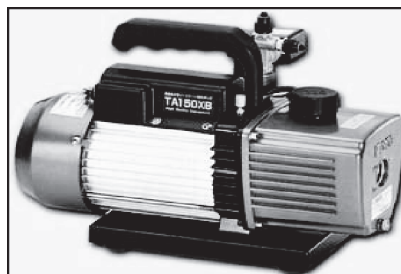

Vacuum pump adopter

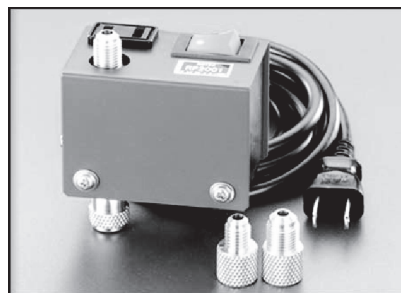

7. HFC refrigerant_Electric gas leakage tester
 R32 refrigerant is often used for other mixed refrigerant (R410A, R404A, R407C etc.). Therefore, the usage of existing HFC detectors is possible, but in order to detect more accurately, we recommend to use detectors specially set and adjusted for R32 detection.

HFC refrigerant_Electric gas leakage tester



8. Digital scale for refrigerant charging
 R32 and R410A have high pressure level and their evaporation speed is high. Thus, if you recover the refrigerant by cylinder charging method, the refrigerant evaporates within the weighing scale glass, which makes reading the scale difficult, rather than liquidating the refrigerant into the cylinder. (Charging cylinders for R22 have different pressure resistance, scale, connection port size; therefore, they are not usable) At the same time, the digital scale for refrigerant charging is strengthened by receiving the weight of the refrigerant cylinders with four pillars at the corners. The connection ports of charging hoses have two separate ports for R22 (7/16 UNF20) and R32/R410A (1/2 UNF20) therefore, they can be used for the insertion of the existing refrigerants.

Digital scale for refrigerant charging

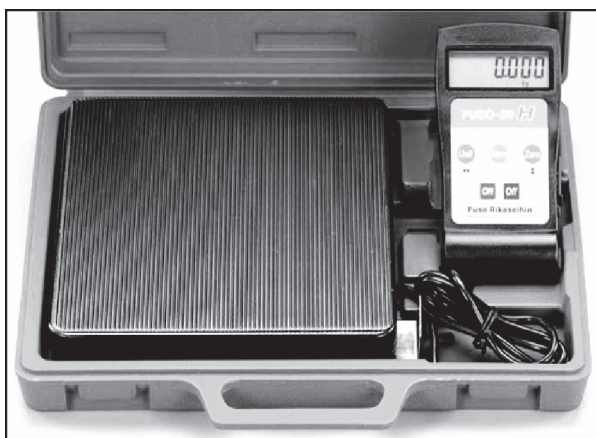

9. Refrigerant cylinders
 Refrigerant cylinders for R410A are painted in pink, and the ones for R32 are painted in other colors that might subject to change according to the international standards. R32 is a single refrigerant, so that both liquid and gas insertion are possible. Additional charging is also possible. (R410A is a mixed refrigerant, so only liquid insertion is possible)

Refrigerant cylinders



10. Connection ports of refrigerant cylinders and packing
 Charging ports which fit to the charging hose connection port size (1/2 UNF20) is needed. At the same time, the packing has to be of HFC resistant materials.

Connection ports and packing

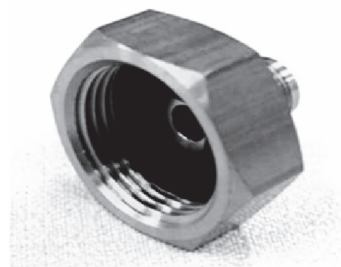

11. Tools used for refrigerant piping installations and services

	Tools for R410A	Common with R32	Possibility of usage for R22
1.	Pipe cutters, reamers or scrapers	○	○
2.	Flare tools (clutch type)	○	○
3.	Torque wrench (1/4, 3/8)	○	○
4.	Torque wrench (1/2, 5/8)	○	×
5.	Manifold gauges · charging hoses	○	×
6.	Vacuum pumps, vacuum pump adopters	○ Connection 5/16	○ Connection 1/4
7.	Electric gas leakage testers for HFC *1	○	△
8.	Digital scale for refrigerant charging	○	○
9.	HCF recovery devices (connection port 5/16) *2	○ Connection 5/16	○ Connection 1/4
10.	Refrigerant cylinders (pressure resistant: FC3)	Same specs ×	×
11.	Refrigerant cylinders (pink)	Other (colors that might subject to change according to the international standards).	×
12.	Refrigerant cylinder connection ports and packing	○	×
13.	Allen wrench (4 mm) Electric knives	○	○
*1	Those testers only for HCFC22 (R22), but not for HCF32 (R32) and HCF410A (R410A) cannot be for common use.		
*2	Recovery devices which are self-certified for each HCF type can be used.		
	<p>[Knowledge for the common usage of tools for R410A & R32]</p> <ul style="list-style-type: none"> • R410A and R32 machines use different compressor oils. • If unregulated compressor oil gets mixed into, it may cause damage to the machine function. • Careful pump down will ensure the recovery of compressor oil, and it will minimize the remaining amount of the oil in the manifold gauge and charging hose. • If you only perform the recovery of refrigerant and not be able to perform pump down, <u>you have to dispose the compressor oil in the charging hose.</u> 		
	<p>[Precaution of repairing refrigerant cycle]</p> <ul style="list-style-type: none"> • In the brazing, open 2-way and 3-way valves, and make sure the refrigerant is completely recovered back and not remaining the system. • When repairing outside, make sure no refrigerant is in the air, ensure good air flow, and perform the brazing. 		
	<p>[Inserting wrong refrigerant]</p> <ul style="list-style-type: none"> • It may cause “not cooling” and “not heating” customer claims because each component (expansion valve, compressor, PCB) of the refrigeration cycle is specially adjusted for R32. • At the same time, it is not subject to product warranty, if wrong refrigerant was inserted into the system. 		

13.4 New installation, Relocation, Repairing of Refrigerant Cycle System The Procedures

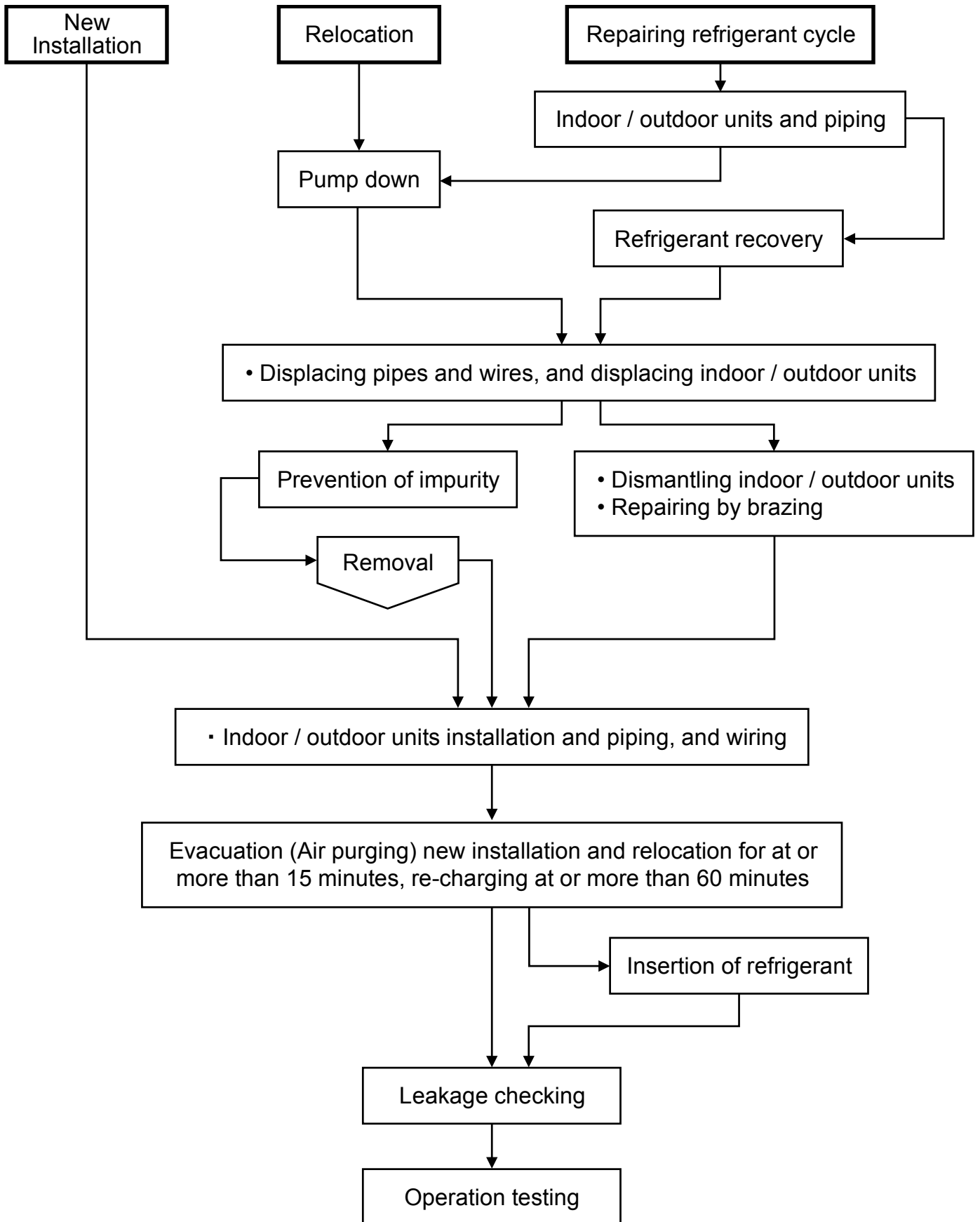

13.5 Piping installation of R32

13.5.1 Pipe materials used and flaring

Copper pipes are used for refrigerant piping. Pipes which comply with JIS Regulations need to be used. Room air conditioners which use R410A and R32 have higher pressure; thus, using pipes which comply with the Regulations is important.

The pipe thickness is regulated by revised JIS B 8607 "Flaring and brazing fittings for refrigerant" and the pipe thickness for R410A, R32 is shown in the table.

Pipe thickness

O and OL materials		Thickness (mm)		
Diameter	Diameter (mm)	R410A	R32	R22
1/4	6.35	0.80		
3/8	9.52	0.80		
1/2	12.70	0.80		
5/8	15.88	1.00		

Caution

- For connection piping, use copper phosphate seamless pipes (1220T) as regulated in "JIS H 3300" and the pipe thickness is 0.8 mm.
- In the market, there are some pipes of 0.7 mm thickness, but do not use these pipes (0.8 mm thickness has to be strictly followed).
- It is recommended to use pipes whose adhesion amount of oil is at or less than 40 mg / 10 m. At the same time, do not use pipes with dent, de-shape, and color change (especially inside).

13.5.2 Processing and connection of pipes

For refrigerant pipe installation, be aware of moisture and dirt do not get into the pipes, and make sure of no refrigerant leakage.

◎ The procedure of flaring and precautions

- Cutting of pipes : use pipe cutter and cut the pipe slowly not to de-shape the pipe.
- Removal of burrs on the edge of pipe (reamer or scraper)
If the condition of pipe edge after the deburring is no good or if burrs attaches on the flaring, it may cause refrigerant leakage. Turn the pipe end down and perform deburring carefully.
- Insert the flare nut (use the nut which is a part of the CZ parts)
- Flaring

Ensure the cleanliness of clump bar and pipe, and perform flaring carefully.

Use the existing flare tools or flare tools for R410A. Be aware that the sizes and dimensions of flaring is different in each flaring tool. If you use the existing flaring tools, use flaring gauge to measure the length of the flaring part.

Piping size (mm)	Dimensions "a" (mm) R22			Dimensions "a" (mm) R410A/R32		
	Flare tools		Flare tools for R410A	Flare tools		Flare tools for R410A
	Clutch type	Wing nut type	Clutch type	Clutch type	Wing nut type	Clutch type
6.35 (1/4")	0.5 ~ 1.0	1.0 ~ 1.5	0 ~ 0.5	1.0 ~ 1.5	1.5 ~ 2.0	0 ~ 0.5
9.52 (3/8")	0.5 ~ 1.0	1.0 ~ 1.5	0 ~ 0.5	1.0 ~ 1.5	1.5 ~ 2.0	0 ~ 0.5
12.70 (1/2")	0.5 ~ 1.0	1.5 ~ 2.0	0 ~ 0.5	1.0 ~ 1.5	2.0 ~ 2.5	0 ~ 0.5
15.88 (5/8")	0.5 ~ 1.0	1.5 ~ 2.0	0 ~ 0.5	1.0 ~ 1.5	2.0 ~ 2.5	0 ~ 0.5

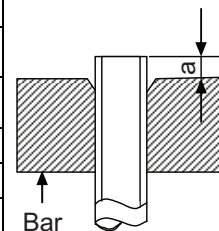

Nut outer diameter (mm)	
R22	R410A R32
17	17
22	22
24	26
27	29

13.6 Installation, Relocation, and Service

13.6.1 Air purge and gas leak test for new installation (using new refrigerant pipes) using vacuum pump

(From the point of view of global environment protection, do not release CFCs into the atmosphere during installation work)

1. Connect the charging hose of manifold gauge to the service port of 3-way valve (pushing insect pin).
2. Fully open the handle Lo of manifold gauge and operate vacuum pump.
(If the needle of the low-pressure gauge reaches the vacuum immediately, check 1 procedure again)
3. Perform vacuuming 15 minutes or more, and make sure low pressure gauge reaches to -0.1 MPa (-76cmHg).
When the vacuuming completes, fully open the handle Lo of manifold gauge and stop the operation of vacuum pump, and leave it for 1 ~ 2 minutes. Then, remove the connection side of the charging hose of vacuum pump adaptor after checking the needle of manifold gauge does not turn back.
4. Open the stem of 2-way valve to 90° in anti-clock wise, and close the 2-way valve after 10 seconds, and perform gas leakage test.
5. Remove the charge hose from the service port of 3-way valve, and open the stems of 2-way and 3-way valves (open the valves to anti-clock wise carefully, do not use full strength to open)
6. Tighten the service port cap with torque wrench $18\text{ N}\cdot\text{m}$ ($1.8\text{ kgf}\cdot\text{m}$)
Tighten the caps of 2-way and 3-way valves with torque wrench $18\text{ N}\cdot\text{m}$ ($1.8\text{ kgf}\cdot\text{m}$)
7. After the tightening of each cap, check gas leakage around the cap.

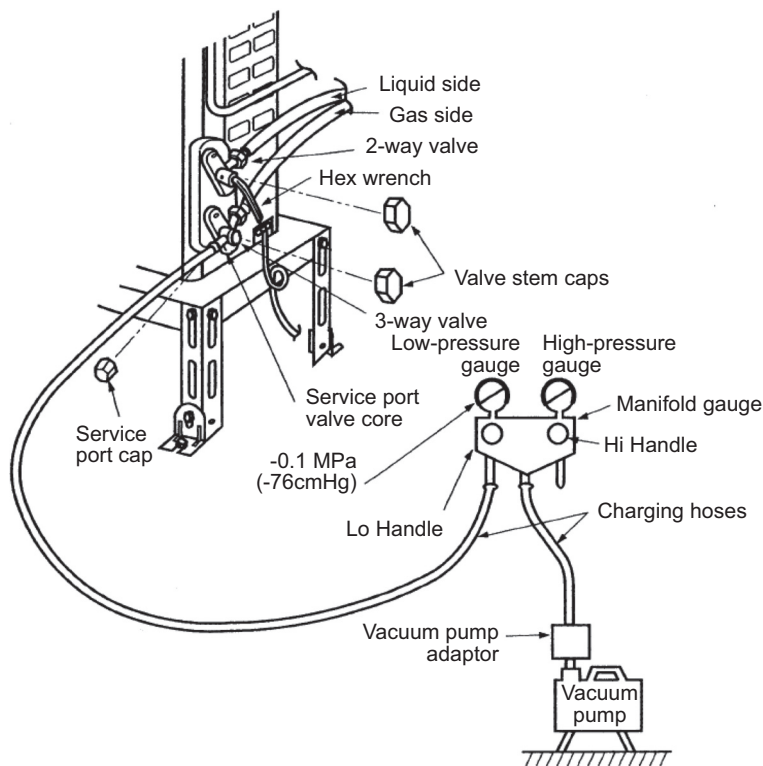

13.6.2 Process of refrigerant recovery

1. Connect the center charging hose of manifold gauge to the in-let side of recovery device.
2. Connect the valves of the discharge side of recovery device and liquid side of refrigerant cylinder with red hose (charging hose).
3. Connect the yellow float switch cable of the recovery device to the refrigerant cylinder.
4. Open the low pressure side valve of manifold gauge.
5. Slightly loosen the charging hose of in-let connecting side of recovery device and perform air purge.
6. Open the liquid valve of refrigerant cylinder and slightly loosen the charging hose in discharging side of recovery device, and perform air purge (the recovery cylinder needs slight inside pressure).
7. Insert electric plug of recovery device into electrical outlet (the fan operation starts).
8. Turn the valve 1 and 2 of recovery device to pressure equalization point.
9. After a few seconds, turn back the valve 1 and 2 to the original position.
10. Turn the switch of the recovery device to "ON". (the compressor operation starts)
11. When the low pressure of manifold gauge is close to "0", close the low pressure side valve, turn "OFF" the recovery device switch.
12. Remove the center charging hose of manifold gauge from the recovery device.

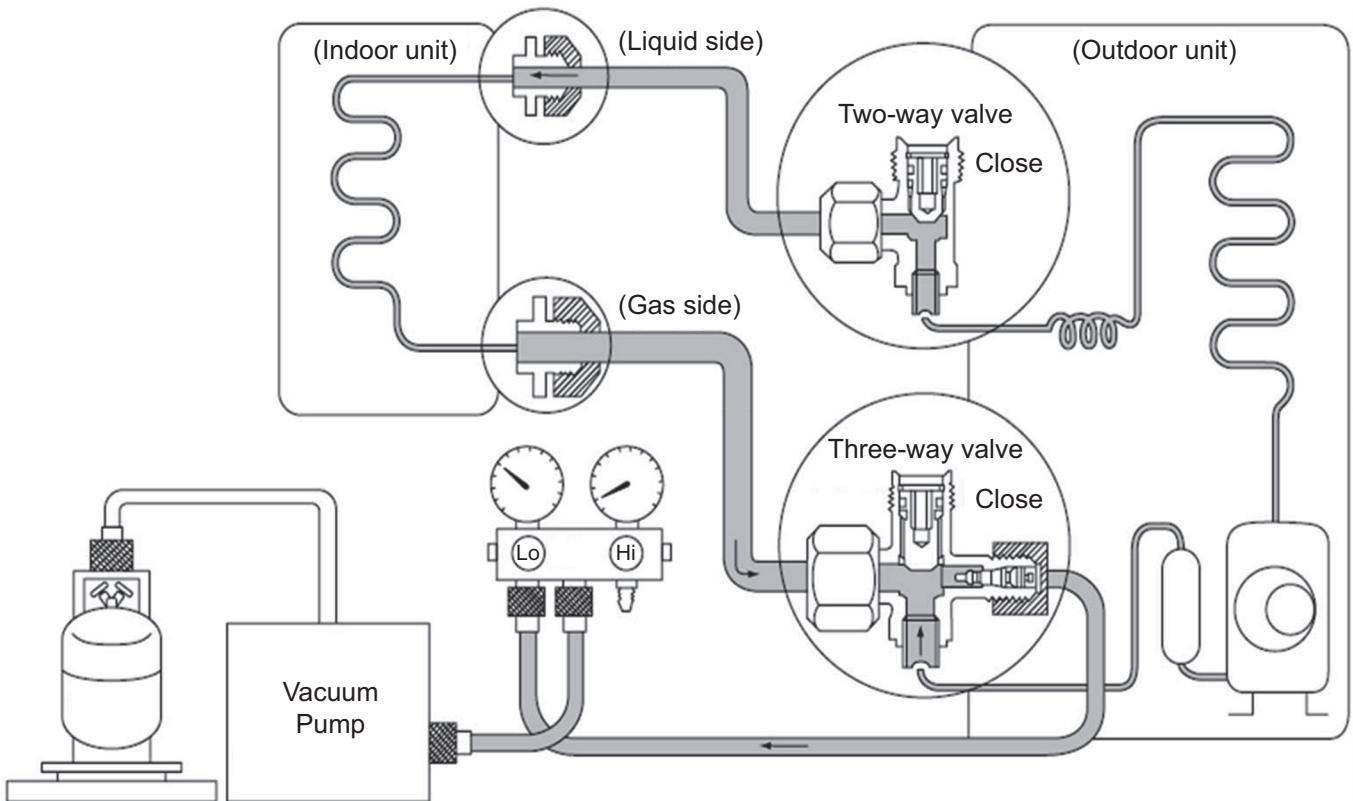

13.6.3 Relocation

1. Removing the air conditioning unit

a) Recovery of outdoor unit refrigerant by pumping down

Press “forced cooling button” (as a general rule, since 1998 the name of cooling testing button is changed, and this name is unified within the air conditioning industry), and then you are able to start cooling operation in which the room temperature is low, and you can recover the refrigerant from the outdoor unit.

1. Check the valve stems of two-way and three-way valves are open by being turned to anti-clockwise (Remove the caps, and confirm the bars are fully open. Use hexagon wrench <4 mm> to open and close the valves).
2. Press the “Emergency Operation” button of the indoor units for five seconds and release [Forced cooling operation] (for old models, press “forced cooling” button). Then, operate the air conditioning unit for about 10 minutes.
3. Turn the stem of the two-way valve to the clock-wise and close the valve.
4. After about 2 ~ 3 minutes, turn the stem of the three-way valve quickly to the clock-wise, and stop the operation.

Caution: In the pump down operation, stop the compressor before removing the refrigerant pipes.

If you do not stop the compressor operation, and if the valve is open and remove the refrigerant pipes, the air may be sucked into the system and causes extreme high temperature in the refrigerant cycle. This may result in rupture or injury, etc.

5. Attach and tighten the caps of two-way and three-way valves with torque wrench.
6. Remove the connecting pipes (liquid side and gas side).

b) Removal of indoor and outdoor units

1. Remove the connecting pipes and wires between the indoor and outdoor units.
2. Attach capping flare nuts on the edges of the pipes, connecting the indoor and outdoor units, in order to prevent dust and moisture get into the pipes.
3. Remove the indoor and outdoor units.

2. Unit installation

Use new refrigerant pipes for the installation, and perform air purging using vacuum pump and gas leakage testing stated in 14.5.1.

13.6.4 Replacement of air conditioning units and evacuation (when re-using the existing pipes)

When replacing the air conditioning units, you might use the existing pipes, but it is recommended to perform flaring again. In case of unit replacement, even if the unit is new refrigerant air conditioner, if the refrigerant oil is different, it may cause problem. Further, when re-using the existing refrigerant pipes, it is recommended to evacuate the pipes as much as possible, due to the reason that much refrigerant oil may be attached on the surface of the pipes. If the pipes are used without evacuation, the remaining refrigerant oil may cause under-performance and abnormal refrigerant cycle caused by non-compatibility of those oils.

13.6.5 Inter-changeability of refrigerant

Do not operate air conditioning units inserting wrong (or mixed) refrigerant (R22, R410A, R32). It may cause malfunction of the units, and at the same time, may cause serious incident such as rupture of the refrigerant cycle.

13.6.6 Re-insertion of refrigerant in service

When re-insertion is needed, follow the procedures to ensure the insertion of new refrigerant at correct amount.

1. Attach charging hose (blue) to the service port of the outdoor unit.
2. Attach charging hose (red) to the vacuum pump. Fully open the 2-way and 3-way valves.
3. Place the refrigerant cylinder on the digital scale for refrigerant charging and connect the charge hose (yellow) to the connection port of the vacuum pump and the digital scale. Leave the cylinder valve fully open.
4. Fully open the handles Lo and Hi of the manifold gauge, and switch on the vacuum pump, and then perform evacuation for at or more than one hour.
5. Confirm the compound gauge of -0.1 MPa (-76 cmHg) and fully open the handles of Lo and Hi, and switch off the vacuum pump. Leave it for about 1 ~ 2 minutes and confirm the needle of the compound gauge does not turn back.

Refer to the picture below to follow the procedures below.

6. Remove the charging hose (red) of the manifold gauge from the vacuum pump adaptor.
7. After adjusting the digital scale to zero, open the cylinder valve and the valve Lo of the manifold gauge, and insert the refrigerant.
8. If it is not possible to insert the refrigerant at regulated amount at once, operate the cooling mode and gradually insert the refrigerant (recommended amount approx. $150 \text{ g} / 1 \text{ time}$)
*Do not insert much refrigerant at once.
9. Close the open/close valve and insert the refrigerant in the charging hose to the outdoor unit.
*Perform this procedure during operating cooling operation. Close the stem of the two-way valve, and when the pressure of the manifold gauge becomes zero (0), quickly remove the charging hose (blue). Immediately open the 2-way valve, and stop the cooling operation.
10. Final checking ••• Confirm the 2-way and 3-way valves are fully open.
Attach the caps of the service port and control valve, and then check the gas leakage around the caps.

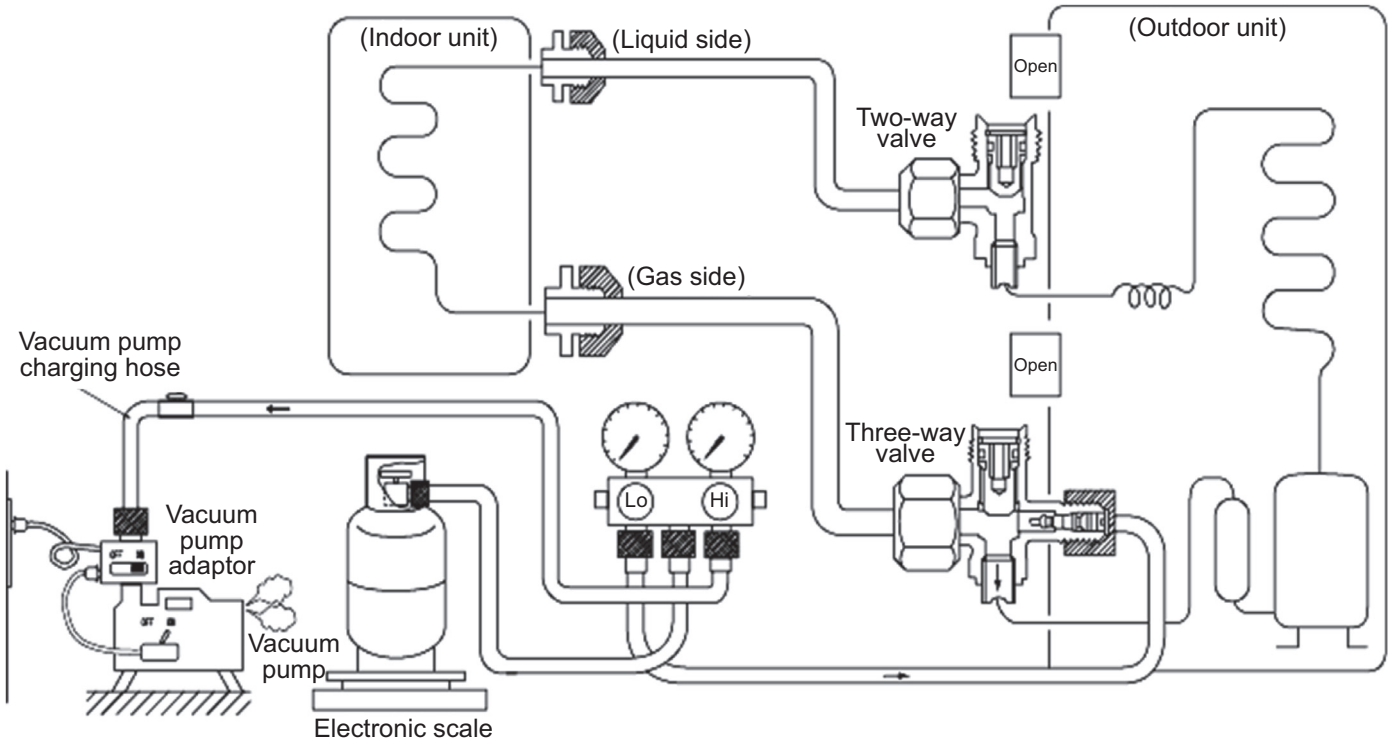

13.7 Repairing of refrigerant cycle / Brazing point

13.7.1 Preparation for repairing of refrigerant cycle / brazing

Brazing which is a technique needed for repairing refrigerant cycle requires advanced technique and experience, and this brazing procedure can only be performed by the workers who completed "Gas Welding Skill Training" regulated by the Occupational Safety and Health Act, and went through the training programs of refrigerant operations. Dismantling and re-connecting (assembling) refrigerant system requires working space, and the space has to ensure good air flow and fire prevention (water bucket and fire extinguisher). Moreover, the worker has to ensure the wearing of goggles, gloves, safety shoes, and long sleeve shirts, and be aware of work safety and attempt to prevent secondary defect (quality assurance of products). For brazing the indoor / outdoor unit structural components (heat exchangers, compressors, expansion valves, four-way valve blocks), after the recovery of all refrigerant, confirm that no refrigerant remains in the system, and fully open the 2-way and 3-way valves. When the brazing is conducted outside, check and make sure no refrigerant is contained in the air (be careful with vaporized refrigerant). Furthermore, protect the compressor terminal with metal plates, and heat but use wet clothes to cool down (releasing the heat) the expansion valves, and four way valves (prevent destruction of parts). In brazing, it is important to pour the brazing material without melting the base metal based on capillary action principle. In case of holes and oxidizing caused by overheating, do not perform re-brazing or alteration but replace the parts.

13.7.2 Adjustment of vacuum pump pressure

1. Cylinder with adjustment handle

1. Check and confirm the adjustment handle of the 1st pressure adjuster is loosen (anticlockwise). If cylinder valve is opened when the 1st gauge pressure adjust handle is closed, the 2nd gauge might get broken.

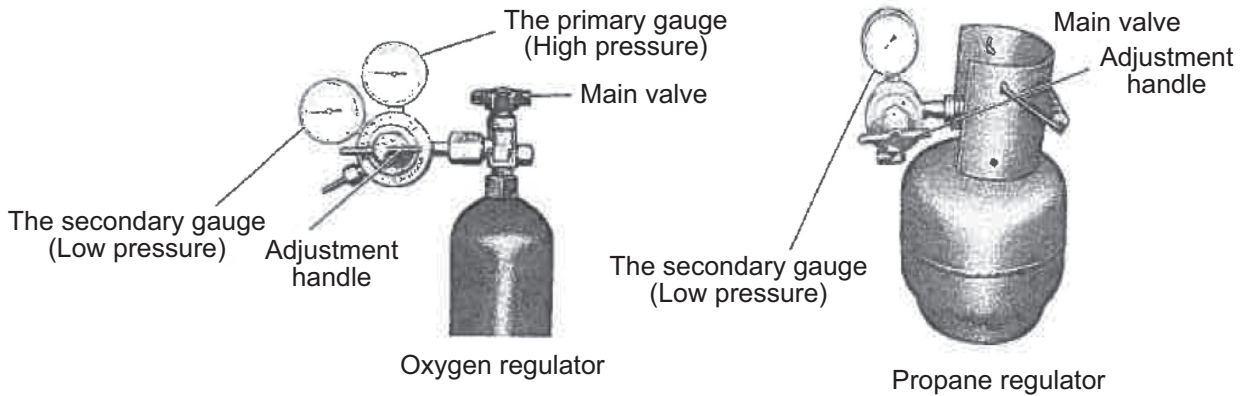

2. Open the cylinder valve, and check the remaining amount with the first side pressure gauge.
3. Check the pressure of 2nd gauge and turn the adjustment handle to clock-wise direction to adjust the pressure.
 - ⊙ Oxygen 2nd side gauge pressure 0.5 MPa (5.0 kgf / cm²)
 - ⊙ Propane 2nd side gauge pressure 0.05 MPa (0.5 kgf / cm²)

2. Cylinder without adjustment valve
 2nd side gauge pressure is adjusted by the adjuster.
 Check the both side valves of the torch and open the cylinder valve to check the remaining refrigerant in the cylinder.
 Caution: Do not attach oil component on the connection port of the adjuster.
 Especially, use an oxygen cylinder adjuster which is no oil substance type. Do not dismantle or repair the adjuster and pressure gauge.

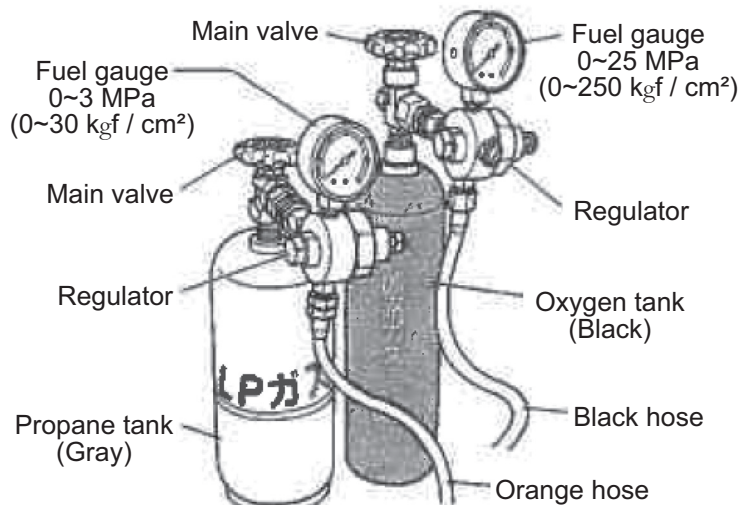

13.7.3 Checking of gas provision

Checking there is no fire around the torch, and then confirm the provision of gas.

1. Slightly open the “propane valve” of the torch, and make sure the gas comes out from the torch crater and then close the “propane valve”.
 2. Slightly open the “oxygen valve” of the torch and make sure the gas comes out from the torch crater and then close the “oxygen valve”.
- Check there is no gas leakage around the hose connection.

13.7.4 Adjustment of flame

1. Slightly open the “propane valve” of the torch and lit with spark lighter.
 This moment, the flame is only by propane and the color is red.
2. Gradually open the “oxygen valve” of the torch to mix oxygen, and adjust the amount of propane and oxygen with the valve to make the flame suitable for brazing work.
 If the white core flame splits into two, the torch crater might be clogged. In this case, remove the crater from the torch and check.

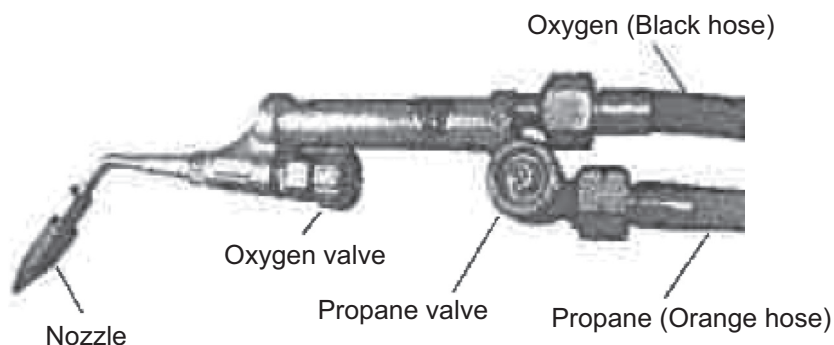

13.7.5 Types of flame

Types of flame change based on the proportion of propane and oxygen.

[Neutral Flame]

Perform brazing with this flame

(This is a flame when oxygen and propane are mixed at proper proportion, and has lesser effect on the brazed metals)

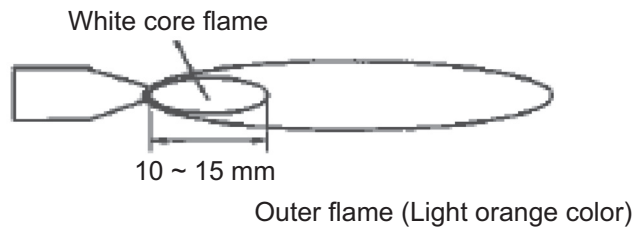

[Carbide Flame]

When propane is excessive, the flame has white color flame in between the white core flame and outer flame. (This is due to the lack of oxygen and the proportion of unburned propane is excessive. The black carbon created during the brazing work may contaminate the surface of the brazed metal).

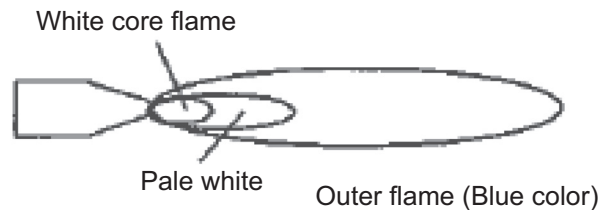

[Oxidizing Flame]

Oxygen is more compared to the neutral flame. Although the flame size is small, this has the highest flame heat. However, due to the excessive oxygen contained in the flame, the brazing point gets oxidized. (This flame may cause holes, due to the high heat. The pipe may get melt)

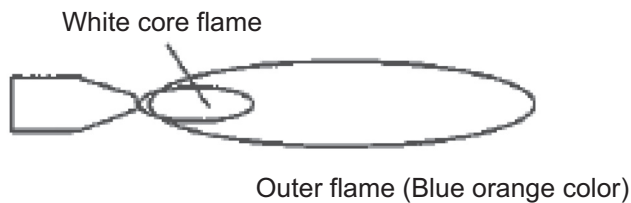

13.7.6 Closing the flame

[In case of short break]

1. Close the "propane valve" of the torch.
2. Close the "oxygen valve" of the torch.

[In case of finishing work]

1. As above, close the flame following the procedure of "In case of short break".
2. Completely close the valves of oxygen and propane cylinders.
3. Release the remaining gas inside the hose by opening the "oxygen valve" and "propane valve" of the torch. Confirm the 1st and 2nd side gauge pressures of "oxygen" and "propane" cylinder pressure adopter are "zero".

13.7.7 Selection of brazing material

Use BA_g brazing material (silver solder) to increase the welding performance.

Category	JIS Standard Number	Composition of ingredients (%)						Temperature (°C)			Tensile strength (Reference)		Characteristics and applications
		Ag	Cu	Zu	Cd	Ni	P	Solidus	Liquidus	Brazing temp	Kgf·cm ²	Base material	
BA _g	BA _g • 1A	49.0 ~ 51.0	14.5 ~ 16.5	14.5 ~ 18.5	17.0 ~ 19.0	—	—	approx. 625	approx. 635	635 ~ 760	45.5	S20C	Liquidity is good at low temperature, it is preferable to a small junction of the gap in the universal form.
	BA _g • 1	44.0 ~ 56.0	14.0 ~ 16.0	14.0 ~ 18.0	23.0 ~ 25.0	—	—	approx. 605	approx. 620	620 ~ 760	45.5	S20C	It has similar performance to the BA _g • 1A, and suitable for every base material except the light weight metal.
	BA _g • 2	34.0 ~ 36.0	25.0 ~ 27.0	19.0 ~ 23.0	17.0 ~ 19.0	—	—	approx. 605	approx. 700	700 ~ 845	45.5	S20C	It is a brazing filler metal in universal form, suitable for a slightly larger gap junction.
	BA _g • 3	48.0 ~ 51.0	14.5 ~ 16.5	13.5 ~ 17.5	15.0 ~ 17.0	2.5 ~ 3.5	—	approx. 630	approx. 690	690 ~ 815	35 ~ 70	SS ~ SUS	It has good corrosion resistance in stainless steel-based brazing, suitable for brazing tungsten carbide, aluminum bronze and copper.
BCuP	BCuP-2	—	remain	—	—	—	6.8 ~ 7.5	approx. 710	approx. 785	690 ~ 815	21 ~ 24.5	Cu	Good liquidity, suitable for brazing copper tube.
	BCuP-3	4.8 ~ 5.2	remain	—	—	—	5.8 ~ 6.7	approx. 645	approx. 815	720 ~ 815	21 ~ 24.5	Cu	Suitable for brazing when the joint spacing is not constant
	BCuP-5	14.5 ~ 15.5	remain	—	—	—	4.8 ~ 5.3	approx. 645	approx. 800	705 ~ 815	21 ~ 24.5	Cu	When brazing of copper and copper, it is used without a flux, but not possible for brazing basic materials

Caution

BCuP (phosphorus copper wax) is easy to react with sulfur, and makes a brittle compound water soluble, and causes gas leakage. In hot spring areas, use other brazing materials or paint the surface for protection.

13.7.8 Need of flux

Use flux to protect the base materials.

1. Remove impurity and oxide film on the metal base, and improve the flow of the brazing material.
2. Prevent oxidation of the metal surface in brazing.
3. Reduce the surface tension of the brazing material.

13.7.9 Need of nitrogen gas

In order to prevent oxidation in the pipe, perform the brazing operation in nitrogen gas flow. Flow rate 0.05 m³ / h, or pressure reducing valve at 0.02 MPa (0.2kgf / cm²) below.

13.7.10 Checking of brazing (insert) points

1. No impurity on the brazing point
If dirt or oil is attached on the brazing point, the brazing filler metal does not reach to junction, and it may cause poor welding.
2. Adequate gap space in the brazing point
The advantage of capillary current situation is used in brazing. If the gap space is too large, this phenomenon may not occur and it may cause poor welding because brazing filler metal does not flow to join the front part.
3. Appropriate size for insertion
The guideline for pipe insertion dimensions is to three times the diameter of the base material, but you need to decide the insertion size in consideration of the clogging of the brazing material. Generally, for thin pipes, you need to increase the insert size, and for thick pipe vice versa.

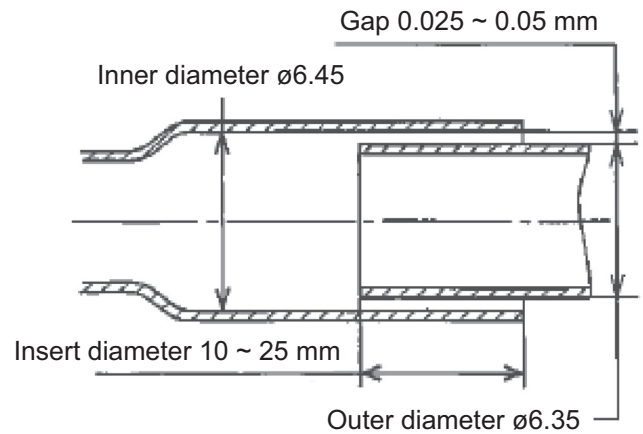

4. Brazing material to flow from top to bottom
Brazing filler metal will easily flow to the connecting portion by capillary action. Further, by bending the brazing portion of [dryer side] of the capillary tube at 120°, you can prevent the damage of dryer inside and the clogging of brazing material caused by the excessive insertion of capillary tube.

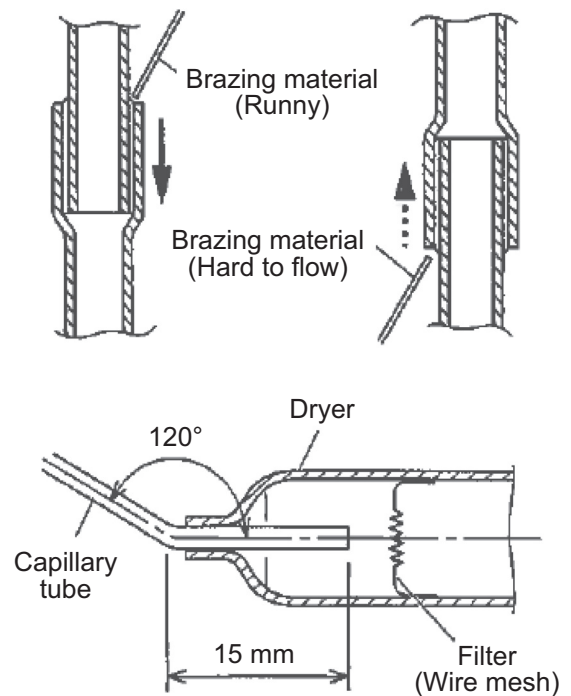

13.7.11 Brazing and heating

1. Place the flame to a pipe which has more heat capacity in order to let the brazing material melt by the pipe heat. Heat the pipe up to the melting temperature of the brazing material, but when it is overheating, assess the temperature by pipe color in order not to melt the pipe.

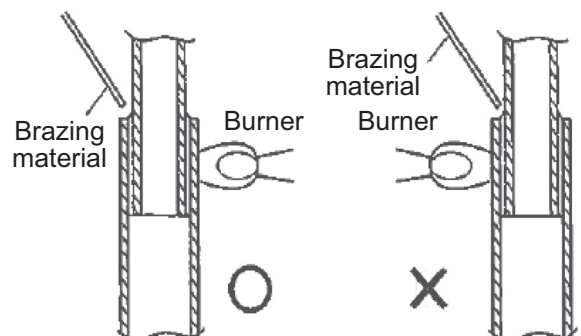

The pre-heating is to heat the base material until the melting temperature, and requires certain training to distinguish the color of the heated base material in order not to melt the material.

The color and temperature of copper tube

- Becoming red color •••••••• 480°C
- Dull red •••••••• 650°C
- Cherish red •••••••• 760°C
- Brightening cherish red •••••••• 870°C

(Reference)

Melting temperature of copper ••••••• Approx. 1083°C

Maximum temperature obtained in propane and oxygen ••••••• Approx. 1083°C

The important point is to heat the bonding part uniformly within a short period of time until reaching to the brazing temperature in the following manner.

2. Apply the flame on to the side with better heat transmission. If the pipe thickness is consistent, by heating like 30% iron and 70% copper, the copper pipe inside reaches to brazing temperature. Iron pipes have low heat transmission and only the part the flame is applied get high temperature, and this causes oxidization of the pipe. The flow of the brazing filler is affected negatively.

3. Apply the flame on to the side of larger heat capacity.

When brazing a thin tubes such as capillary tube and dryer, etc., caution has to be taken to apply the flame to the dryer side (thick pipe side), in order to prevent burn out by the heat.

4. When brazing the compressor connection pipes (suction and discharge), remove the sound insulation plate and the fan, and place the compressor stand vertically (to prevent the leakage of compressor refrigerating machine oil), and apply the flame from the compressor body side.

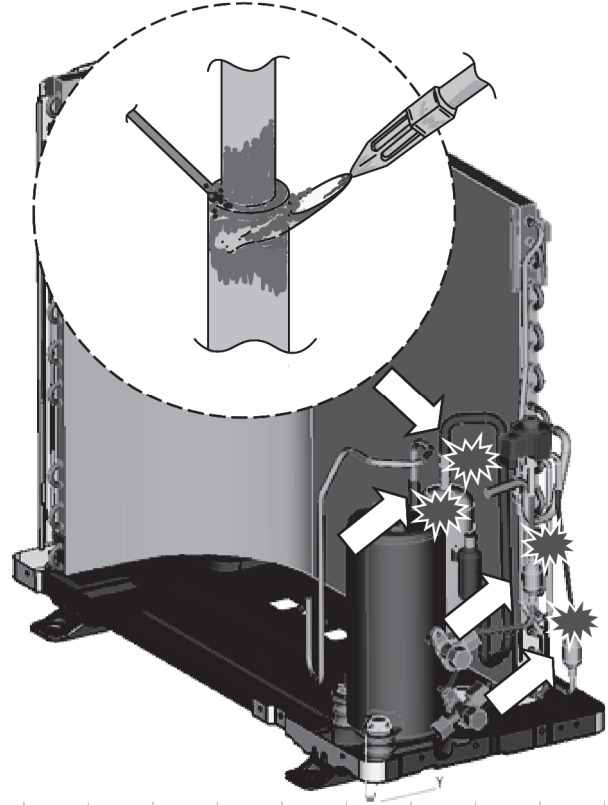

13.7.12 Terminologies of brazing

Pin holes → Small holes are generated on the surface of the brazing metal.

Wet temperature → Liquidus temperature at which the brazing material starts flowing out by heating, generally it is the liquidus-line temperature.

Blow holes → Hollows made by gas in the brazing material of brazing portion (gas reservoirs).

Pits → As a result of blow holes, small dents generated on the outside surface of welding.

Voids → The brazing material does not reach completely to the brazing part. It cannot be identified from outside.

13.8 <Reference> Analysis method for no error code, no cooling / no warming

13.8.1 Preparation for appropriate diagnosis

In order to obtain appropriate operation characteristics, minimum 15 minutes or more operation time [testing operation (rated operation)] is required.

1. Method of rated operation (rated operation)

For the models which have two buttons of “emergency operation and forced cooling operation”, press forced cooling button once. For the models which have only emergency operation button, press the button once for 5 seconds and when hear “beep” sound, release the button. Then, cooling operation starts.

2. Checking the mal-functions of indoor / outdoor units

- 1) Any obstacles against heat release and air suction? (short circuit)
(Forget to remove the outdoor unit cover or fallen leaves blocking the outdoor unit)
- 2) Are the indoor unit air filters clean? (obstructing heat suction)
- 3) Is the setting temperature on the remote controller correct? (is the setting temperature set at lower/higher than the room temperature?)

13.8.2 Understanding and verification of refrigerant cycle

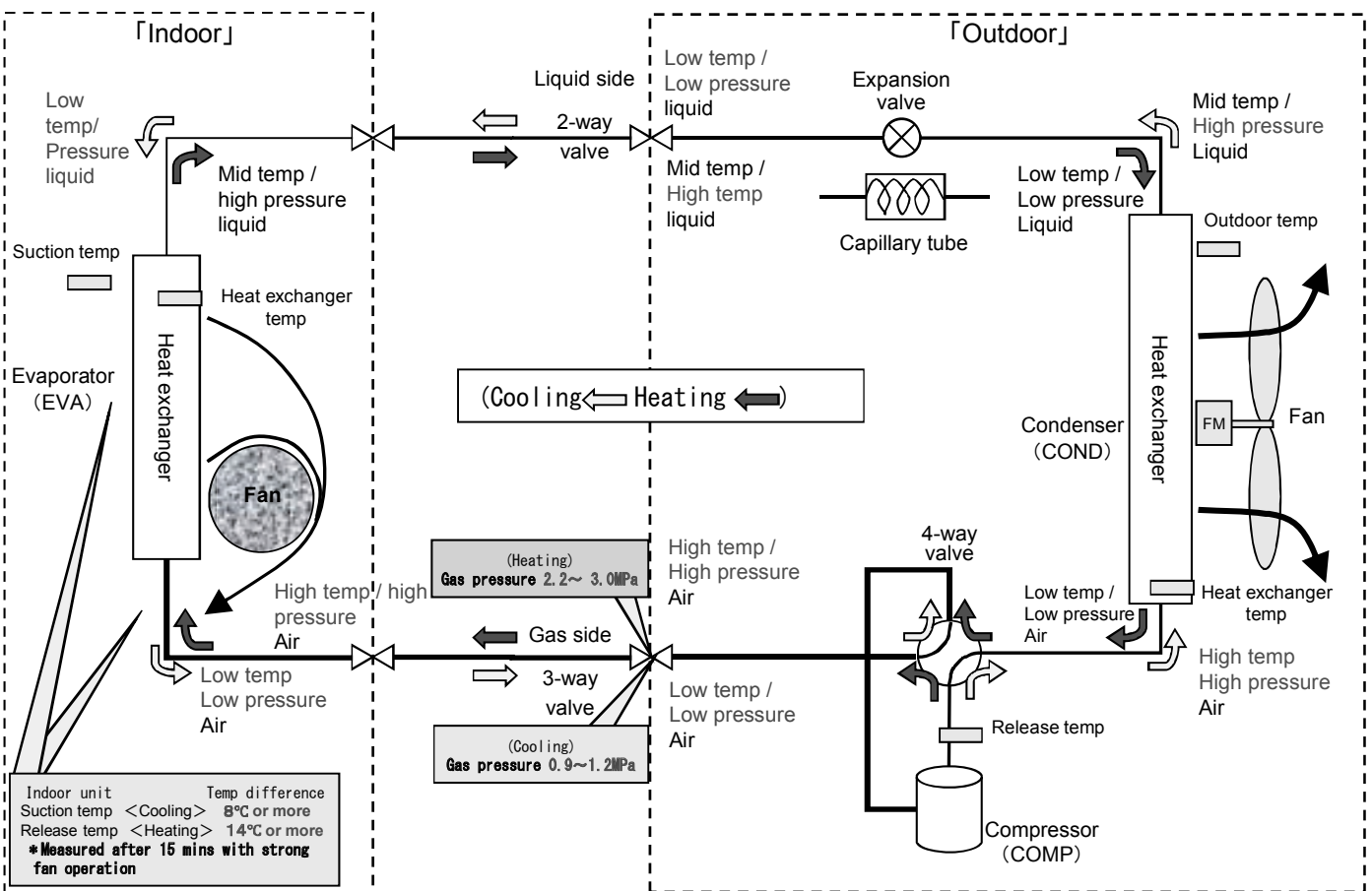

1. Measuring temperature
 - 1) Indoor unit suction temperature, release temperature, temperature difference, → Measure by thermometer
 - 2) 2-way valve pipe temperature in cooling mode is low temperature (benchmark : 5 ~ 10°C), in heating mode is medium temperature (benchmark : 25 ~ 35°C).
 - 3) 3-way valve pipe temperature in cooling mode is low temperature (benchmark : 7 ~ 15°C) in heating mode is high temperature (benchmark : 38 ~ 50°C).
2. Measuring electric current
 - Measuring electric current in operation → check by clamp meter (refer to table of technical characteristic guideline)
3. Measuring pressure
 - Measuring gas pressure → check the pressure by manifold gauge (refer to table of technical characteristic guideline)
4. Any sound from the expansion valve?
(when starting the operation and the outdoor unit is turned on, the expansion valve is re-set, check if there is any edged sound or clack sound)

13.8.3 Guidance for diagnosis of refrigerant cycle

Comparison with normal operation	Cooling mode	
	High	Low
Refrigerant pressure	Excess insertion of refrigerant	Clogged capillary, expansion valve malfunction
	Heat releasing obstruction	Clog by moisture
	Dirty condenser, attachment of impurity	Lack of refrigerant gas
	Compressor malfunction	
Operation electric current	Excess insertion of refrigerant	Lack of refrigerant gas
	Heat releasing obstruction	Compressor malfunction
	Dirty condenser, impurity	Mixture of air
		(Insufficient evacuation)
2-way valve temperature	Excess insertion of refrigerant	Clogged capillary, expansion valve malfunction
	Compressor malfunction	Lack of refrigerant gas
3-way valve temperature	Lack of refrigerant gas • Compressor malfunction	Excess insertion of refrigerant
	Clogged capillary, expansion valve malfunction	

Suction temperature & Release air temperature	Temperature difference at or less than 8°C in cooling operation • • • Causes		
	• Heat releasing obstruction	• Dirty condenser	• Attachment of impurity
	• Lack of refrigerant gas	• Excess insertion of refrigerant	
	• Mixture of air	• Mixture of moisture	
	• Clogged capillary	• Expansion valve malfunction	• Compressor malfunction

◎ Above all are based on the condition that the installation work is properly performed (no issues in indoor / outdoor pipe connections, etc.)

14. Operation Control

14.1 Basic Function

Inverter control, which equipped with a microcomputer in determining the most suitable operating mode as time passes, automatically adjusts output power for maximum comfort always. In order to achieve the suitable operating mode, the microcomputer maintains the set temperature by measuring the temperature of the environment and performing temperature shifting. The compressor at outdoor unit is operating following the frequency instructed by the microcomputer at indoor unit that judging the condition according to internal setting temperature and intake air temperature.

14.1.1 Internal Setting Temperature

Once the operation starts, remote control setting temperature will be taken as base value for temperature shifting processes. These shifting processes are depending on the air conditioner settings and the operation environment. The final shifted value will be used as internal setting temperature and it is updated continuously whenever the electrical power is supplied to the unit.

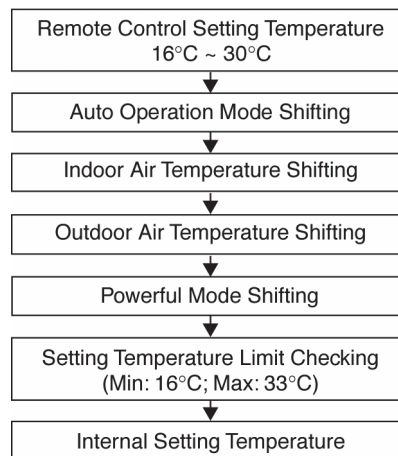

14.1.2 Cooling Operation

14.1.2.1 Thermostat control

- Compressor is OFF when Intake Air Temperature - Internal Setting Temperature < -1.5°C continue for 3 minutes.
- When compressor is OFF (Thermostat OFF) and AUTO FAN is set, the fan will stop periodically.
- Compressor is ON after waiting for 3 minutes, if the Intake Air Temperature - Internal Setting Temperature > Compressor OFF point.

14.1.3 Soft Dry Operation

14.1.3.1 Thermostat control

- Compressor is OFF when Intake Air Temperature - Internal Setting Temperature < -2.5°C continue for 3 minutes.
- When compressor is OFF (Thermostat OFF) and AUTO FAN is set, the fan will stop periodically.
- Compressor is ON after waiting for 3 minutes, if the Intake Air Temperature - Internal Setting Temperature > Compressor OFF point.

14.1.4 Heating Operation

14.1.4.1 Thermostat control

- Compressor is OFF when Intake Air Temperature - Internal Setting Temperature > +2.0°C continue for 3 minutes.
- Compressor is ON after waiting for 3 minutes, if the Intake Air Temperature - Internal Setting Temperature < Compressor OFF point.

14.1.5 Automatic Operation

- This mode can be set using remote control and the operation is decided by remote control setting temperature, remote control operation mode and indoor intake air temperature.
- During operation mode judgment, indoor fan motor (with speed of Lo-) is running for 30 seconds to detect the indoor intake air temperature.
- Every 10 minutes, the indoor temperature is judged.
- For the 1st judgment
 - If indoor intake temperature - remote control setting temperature $\geq 2^{\circ}\text{C}$, COOL mode is decided.
 - If $-2^{\circ}\text{C} \leq$ indoor intake temperature - remote control setting temperature $< 2^{\circ}\text{C}$, DRY mode is decided.
 - If indoor intake temperature - remote control setting temperature $< -2^{\circ}\text{C}$, HEAT mode is decided.

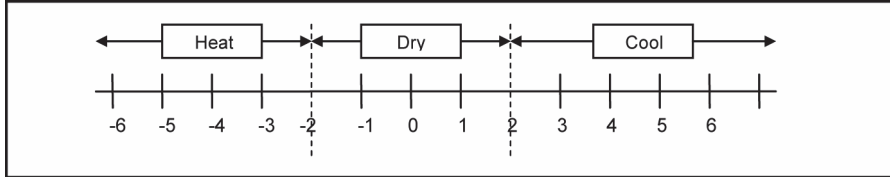

- For the 2nd judgment onwards
 - If indoor intake temperature - remote control setting temperature $\geq 3^{\circ}\text{C}$, if previous operate in DRY mode, then continue in DRY mode. otherwise COOL mode is decided.
 - If $-2^{\circ}\text{C} \leq$ indoor intake temperature - remote control setting temperature $< 3^{\circ}\text{C}$, maintain with previous mode.
 - If indoor intake temperature - remote control setting temperature $< -2^{\circ}\text{C}$, HEAT mode is decided.

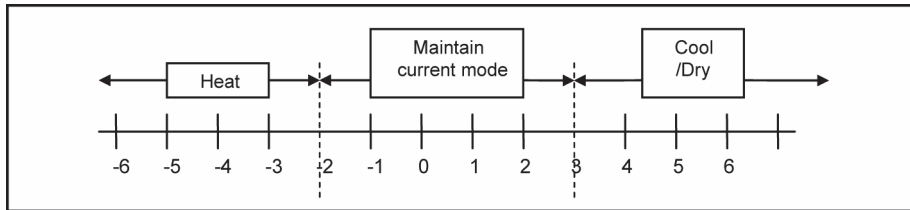

14.1.6 Fan Operation

- Fan Operation is used to circulate air in a room.
- During operation, indoor fan run continuously but outdoor fan and compressor stop.
- Temperature setting is not applicable.

14.2 Indoor Fan Motor Operation

14.2.1 Basic Rotation Speed (rpm)

A. Basic Rotation Speed (rpm)

i. Manual Fan Speed

[Cooling, Dry]

- Fan motor's number of rotation is determined according to remote control setting.

Remote control	○	○	○	○	○
Tab	Hi	Me+	Me	Me-	Lo

[Heating]

- Fan motor's number of rotation is determined according to remote control setting.

Remote control	○	○	○	○	○
Tab	SHi	Me+	Me	Me-	Lo

ii Auto Fan Speed

[Cooling, Dry]

- According to room temperature and setting temperature, indoor fan speed is determined automatically.
- When set temperature is not achieved, the indoor fan will operate according to pattern below.

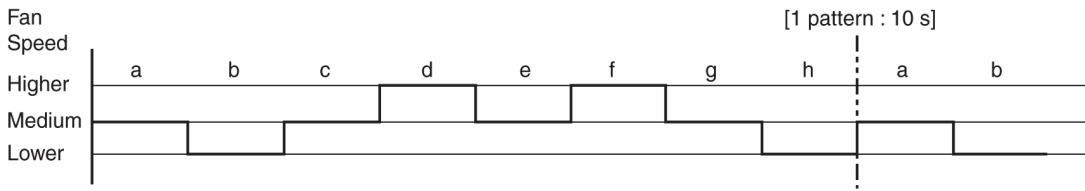

- When set temperature achieved, the indoor fan speed will be fixed. When thermostat off, the fan stop periodically.

[Heating]

- According to indoor pipe temperature, automatic heating fan speed is determined as follows.

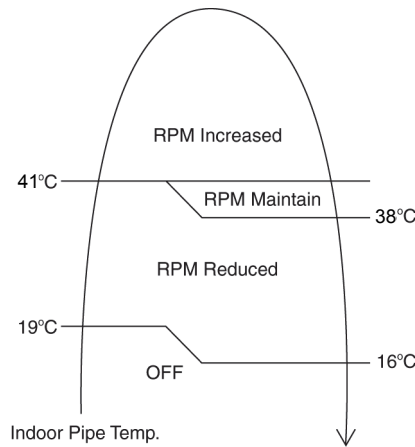

B. Feedback control

- Immediately after the fan motor started, feedback control is performed once every second.
- During fan motor on, if fan motor feedback ≥ 2550 rpm or < 50 rpm continue for 10 seconds, then fan motor error counter increase, fan motor is then stop and restart. If the fan motor counter becomes 7 times, then H19 - fan motor error is detected. Operation stops and cannot on back.

14.3 Outdoor Fan Motor Operation

- It starts when compressor starts operation and it stops 30 seconds after compressor stops operation.

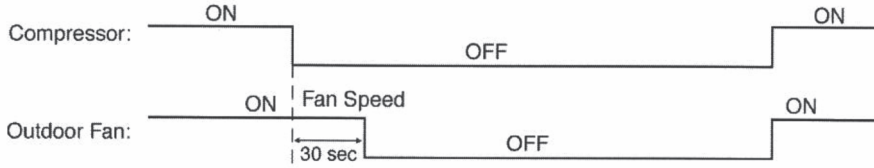

- During cooling operation, and outdoor ambient temperature is below 8°C, outdoor fan speed will be controlled according to outdoor piping temperature as following:

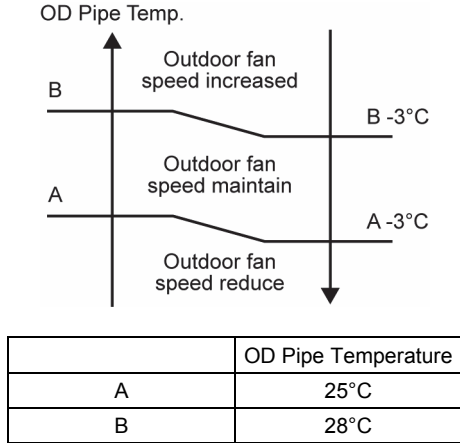

- During above condition, when indoor heat exchanger temperature is below 5°C, the outdoor fan will stop according to outdoor piping temperature as following:

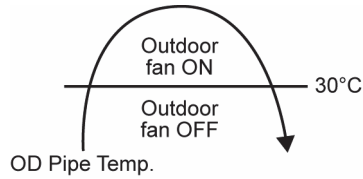

14.4 Airflow Direction

- There are two types of airflow, vertical airflow (directed by horizontal vane) and horizontal airflow (directed by vertical vanes).
- Control of airflow direction can be automatic (angles of direction is determined by operation mode, heat exchanger temperature and intake air temperature) and manual (angles of direction can be adjusted using remote control).

14.4.1 Vertical Airflow

Operation			Up-and-down inner vane				
			Step 1	Step 2	Step 3	Step 4	Step 5
Cooling	Auto	Usual (Ventilation)	[22] degrees – [53] degrees				
		Control with dew	[22] degrees – [53] degrees				
	Manual	Usual (Ventilation)	[22°]	27°	34°	45°	[53°]
		Control with dew	[22°]	27°	34°	45°	[53°]
Dry	Auto	Usual	[22] degrees – [53] degrees				
		Control with dew	[22] degrees – [53] degrees				
	Manual	Usual	[22°]	27°	34°	45°	[53°]
		Control with dew	[22°]	27°	34°	45°	[53°]
Heating	Manual		[28°]	37°	46°	60°	[71°]
	Auto	A zone	[20°]				
		B zone	[64°]				
		C zone	[46°]				

Operation			Up-and-down outer vane				
			Step 1	Step 2	Step 3	Step 4	Step 5
Cooling	Auto	Usual (Ventilation)	[15] degrees – [50] degrees				
		Control with dew	[15] degrees – [50] degrees				
	Manual	Usual (Ventilation)	[15°]	25°	32°	45°	[50°]
		Control with dew	[15°]	25°	32°	45°	[50°]
Dry	Auto	Usual	[15] degrees – [50] degrees				
		Control with dew	[15] degrees – [50] degrees				
	Manual	Usual	[15°]	[25°]	[32°]	[45°]	[50°]
		Control with dew	[15°]	[25°]	[32°]	[45°]	[50°]
Heating	Manual		[28°]	35°	46°	53°	[66°]
	Auto	A zone	[41°]				
		B zone	[51°]				
		C zone	[46°]				

1. Automatic vertical airflow direction can be set using remote control; the vane swings up and down within the angles as stated above. For heating mode operation, the angle of the vane depends on the indoor heat exchanger temperature as Figure 1 below. It does not swing during fan motor stop. When the air conditioner is stopped using remote control, the vane will shift to close position.
2. Manual vertical airflow direction can be set using remote control; the angles of the vane are as stated above and the positions of the vane are as Figure 2 below. When the air conditioner is stopped using remote control, the vane will shift to close position.

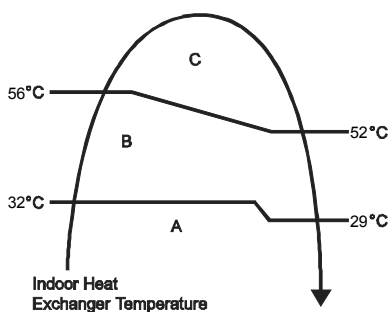

Figure 1

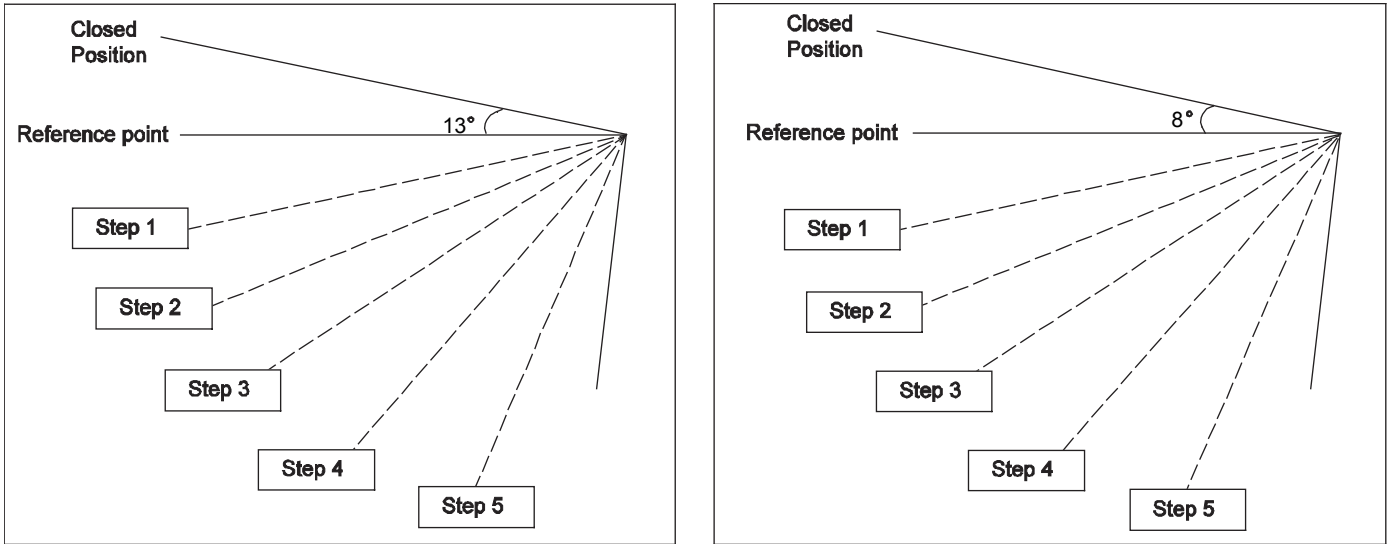

Figure 2

14.4.2 Horizontal Airflow

- Automatic horizontal airflow direction can be set using remote control; the vane swings left and right within the angles as stated below. For heating mode operation, the angle of the vane depends on the indoor heat exchanger temperature as Figure 1 below. It does not swing during fan motor stop.

Operation Mode		Vane Angle (°)
Heating with heat exchanger temperature	A	50 ~ 130
	B	90
Cooling and soft dry		50 ~ 130

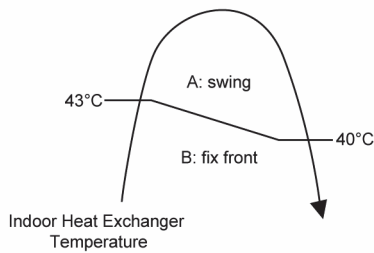

Figure 1

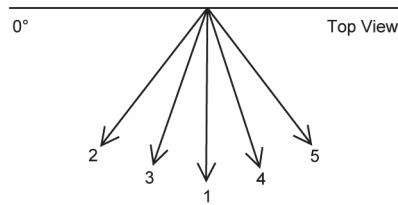

Figure 2

- Manual horizontal airflow direction can be set using remote control; the angles of the vane are as stated below and the positions of the vane are as Figure 2 above:

Pattern	1	2	3	4	5
Airflow Direction Patterns at Remote Control					
Vane Angle (°)	90	50	70	110	130

- * The vertical vane angle tolerance is within +/- 5 degree.

14.5 Quiet Operation (Cooling Mode/Cooling Area of Dry Mode)

- Purpose
 - To provide quiet cooling operation compare to normal operation.
- Control condition
 - Quiet operation start condition
 - When “POWERFUL/QUIET” button at remote control is pressed twice. QUIET will be shown on remote control display.
 - Quiet operation stop condition
 - When one of the following conditions is satisfied, quiet operation stops:
 - POWERFUL/QUIET button is pressed again.
 - Stop by OFF/ON switch.
 - Timer “off” activates.
 - +8/15°C Heat is activated.
 - When quiet operation is stopped, operation is shifted to normal operation with previous setting.
 - When operation mode is changed, quiet operation is shifted to quiet operation of the new mode.
 - During quiet operation, if timer “on” activates, quiet operation maintains.
 - After off, when on back, quiet operation is not memorised.
- Control contents
 - Fan speed is changed to Lo-.

14.6 Quiet Operation (Heating)

- Purpose
 - To provide quiet heating operation compare to normal operation.
- Control condition
 - Quiet operation start condition
 - When “POWERFUL/QUIET” button at remote control is pressed twice. QUIET will be shown on remote control display.
 - Quiet operation stop condition
 - When one of the following conditions is satisfied, quiet operation stops:
 - POWERFUL/QUIET button is pressed again.
 - Stop by OFF/ON switch.
 - Timer “off” activates.
 - +8/15°C Heat is activated.
 - When quiet operation is stopped, operation is shifted to normal operation with previous setting.
 - When operation mode is changed, quiet operation is shifted to quiet operation of the new mode, except fan mode only.
 - During quiet operation, if timer “on” activates, quiet operation maintains.
 - After off, when on back, quiet operation is not memorised.
- Control contents
 - Fan speed manual
 - Fan speed is changed to Lo-.
 - Fan Speed Auto
 - Fan speed is changed to Lo-.

14.7 Powerful Mode Operation

- When the powerful mode is selected, the internal setting temperature will shift lower up to 1°C (for Cooling/Soft Dry) or higher up to 1.5°C (for Heating) than remote control setting temperature to achieve the setting temperature quickly.

14.8 Timer Control

- There are 2 sets of ON and OFF timer available to turn the unit ON or OFF at different preset time.
- If more than one timer had been set, the upcoming timer will be displayed and will activate in sequence.

14.8.1 ON Timer Control

- ON timer 1 and ON timer 2 can be set using remote control, the unit with timer set will start operate earlier than the setting time.
This is to provide a comfortable environment when reaching the set ON time.
- 60 minutes before the set time, indoor (at fan speed of Lo-) and outdoor fan motor start operate for 30 seconds to determine the indoor intake air temperature and outdoor air temperature in order to judge the operation starting time.
- From the above judgment, the decided operation will start operate earlier than the set time as shown below.

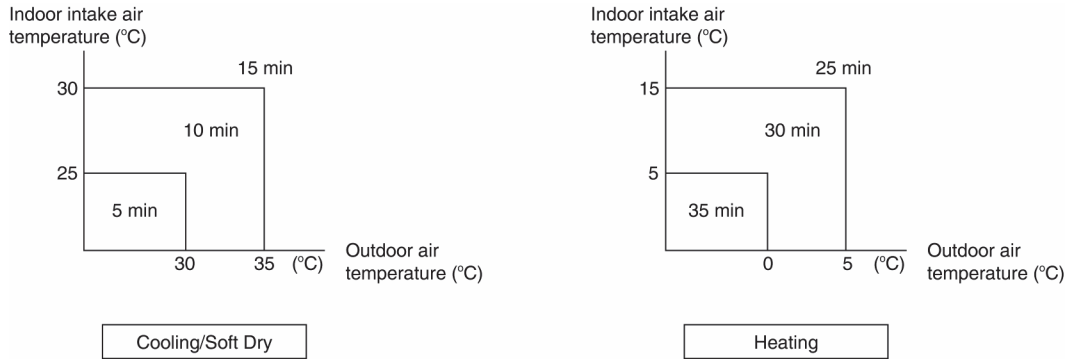

14.8.2 OFF Timer Control

OFF timer 1 and OFF timer 2 can be set using remote control, the unit with timer set will stop operate at set time.

14.9 Auto Restart Control

- When the power supply is cut off during the operation of air conditioner, the compressor will re-operate within three to four minutes (there are 10 patterns between 2 minutes 58 seconds and 3 minutes 52 seconds to be selected randomly) after power supply resumes.
- This type of control is not applicable during ON/OFF Timer setting.
- This control can be omitted by open the circuit of JP1 at indoor unit printed circuit board.

14.10 Indication Panel

LED	POWER	TIMER	+8/15°C HEAT	DEICE
Color	Green	Orange	Green	Blue
Light ON	Operation ON	Timer Setting ON	+8/15°C HEAT ON	DEICE ON
Light OFF	Operation OFF	Timer Setting OFF	+8/15°C HEAT OFF	DEICE OFF

Note:

- If POWER LED is blinking, the possible operation of the unit are Hot Start, operation mode judgment, or ON timer sampling.
- If Timer LED is blinking, there is an abnormality operation occurs.

14.11 +8/15°C Heat Operation

- +8/15°C Heat operation provides heating at low setting temperature in unoccupied houses during winter for the purpose of protecting equipments or housing appliances which may be destroyed by the extreme cold weather.
- This operation can be ON by pressing the +8/15°C heat button on the remote control.
- The temperature settings range are;
 - 8.0°C ~ 15.0°C (Pressing TEMP up and TEMP down button at the remote control)
- During the operation of this mode;
 - The indoor fan speed will remain at Hi fan tap all the time included deice process.
 - Powerful operation, Quiet operation and Fan Speed selection are disabled.
 - Cold draft prevention control is disabled.
- Control condition;

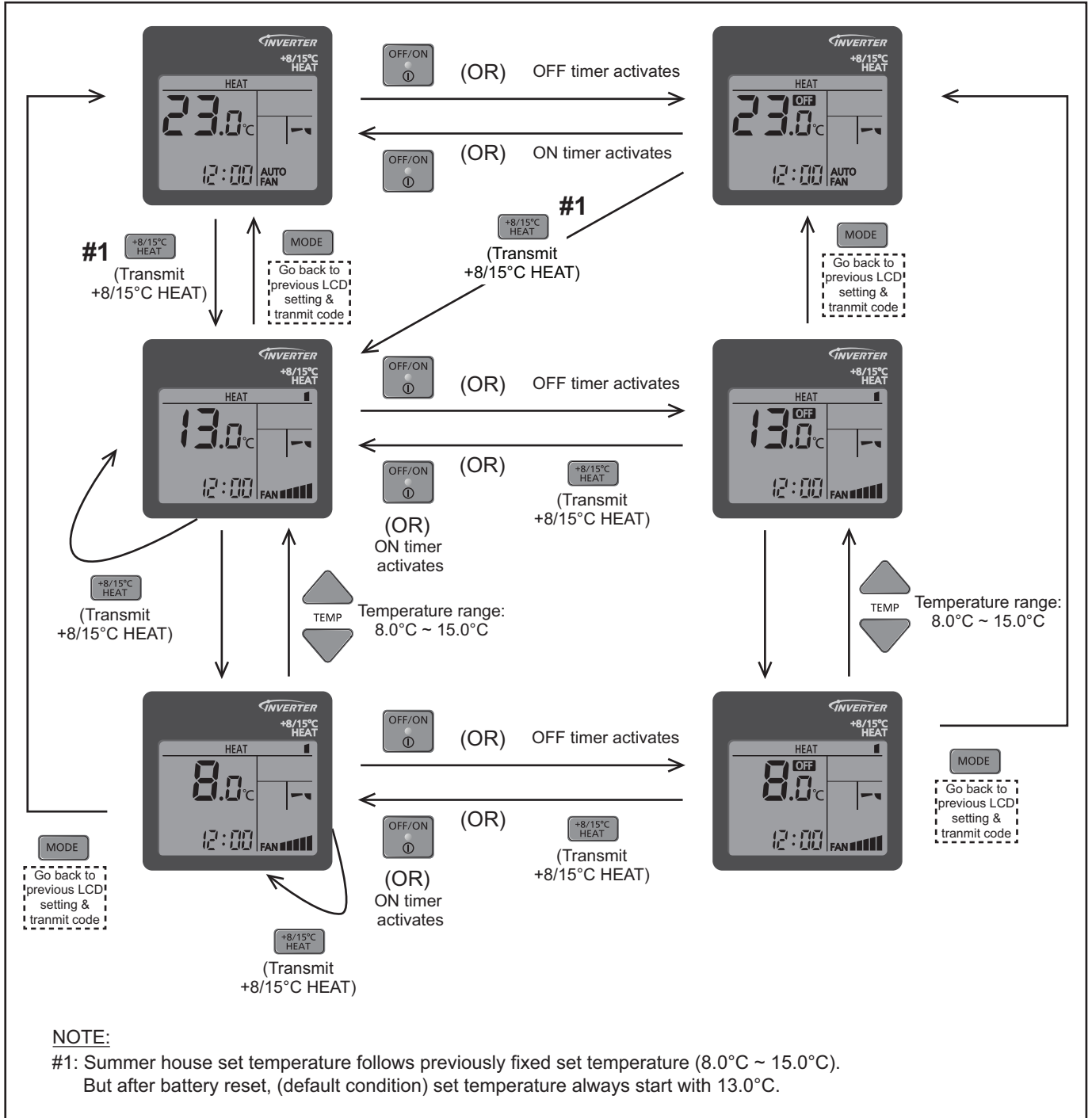

• Caution!

If the indoor temperature constantly is less than 0°C (Door, windows not close properly), the error code F11 may occur. This is because in open area, the indoor sensor will misjudge operation condition and will give error code.

15. Protection Control

15.1 Protection Control for All Operations

15.1.1 Restart Control (Time Delay Safety Control)

- The Compressor will not turn on within 3 minutes from the moment operation stops, although the unit is turned on again by pressing OFF/ON button at remote control within this period.
- This control is not applicable if the power supply is cut off and on again.
- This phenomenon is to balance the pressure inside the refrigerant cycle.

15.1.2 Total Running Current

- 1 When the outdoor unit total running current (AC) exceeds X value, the frequency instructed for compressor operation will be decreased.
- 2 If the running current does not exceed X value for 5 seconds, the frequency instructed will be increased.
- 3 However, if total outdoor unit running current exceeds Y value, compressor will be stopped immediately for 3 minutes.

Model	LZ25TKE		LZ35TKE	
	X (A)	Y (A)	X (A)	Y (A)
Operation Mode				
Cooling / Soft Dry (A)	4.54	14.83	7.01	14.83
Cooling / Soft Dry (B)	4.03		6.50	
Cooling / Soft Dry (C)	4.03		6.50	
Heating	7.52		9.86	

- 4 The first 30 minutes of cooling operation, (A) will be applied.

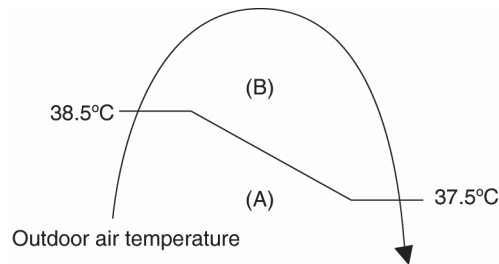

15.1.3 IPM (Power transistor) Prevention Control

- Overheating Prevention Control
 - 1 When the IPM temperature rises to 120°C, compressor operation will stop immediately.
 - 2 Compressor operation restarts after 3 minutes the temperature decreases to 110°C.
 - 3 If this condition repeats continuously 4 times within 20 minutes, timer LED will be blinking ("F96" is indicated).
- DC Peak Current Control
 - 1 When electric current to IPM exceeds set value of $20.2 \pm 2.0A$, the compressor will stop operate. Then, operation will restart after 3 minutes.
 - 2 If the set value is exceeded again more than 30 seconds after the compressor starts, the operation will restart after 1 minute.
 - 3 If the set value exceeded again within 30 seconds after the compressor starts, the operation will restart after 1 minute. If this condition repeats continuously for 7 times, all indoor and outdoor relays will be cut off, timer LED will be blinking ("F99" is indicated).

15.1.4 Compressor Overheating Prevention Control

- Instructed frequency for compressor operation will be regulated by compressor temperature. The changes of frequency are as below.
- If compressor temperature exceeds 103°C, compressor will be stopped, occurs 4 times per 20 minutes, timer LED will be blinking. ("F97" is indicated.)

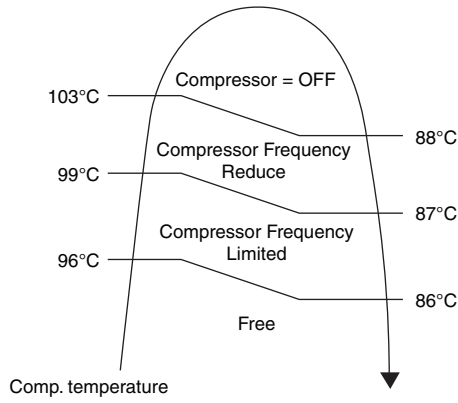

15.1.5 Low Pressure Prevention Control (Gas Leakage Detection)

- Control start conditions
 - For 5 minutes, the compressor continuously operates and outdoor total current is between 0.75A and 0.95A, 1.38A.
 - During Cooling and Soft Dry operations:
Indoor suction temperature - indoor piping temperature is below 4°C.
 - During Heating operations :
Indoor piping temperature - indoor suction is under 5°C.
- Control contents
 - Compressor stops (and restart after 3 minutes).
 - If the conditions above happen 2 times within 20 minutes, the unit will:
 - Stop operation
 - Timer LED blinks and “F91” indicated.

15.1.6 Low Frequency Protection Control 1

- When the compressor operate at frequency lower than 24 Hz continued for 20 minutes, the operation frequency will be changed to 23 Hz for 2 minutes.

15.1.7 Low Frequency Protection Control 2

- When all the below conditions comply, the compressor frequency will change to lower frequency.

Temperature, T, for:	Cooling/Soft Dry	Heating
Indoor intake air (°C)	T < 14 or T ≥ 30	T < 14 or T ≥ 28
Outdoor air (°C)	T < 13 or T ≥ 38	T < 4 or T ≥ 24
Indoor heat exchanger (°C)	T < 30	T ≥ 0

15.2 Protection Control for Cooling & Soft Dry Operation

15.2.1 Outdoor Air Temperature Control

- The compressor operating frequency is regulated in accordance to the outdoor air temperature as shown in the diagram below.
- This control will begin 1 minute after the compressor starts.
- Compressor frequency will adjust base on outdoor air temperature.

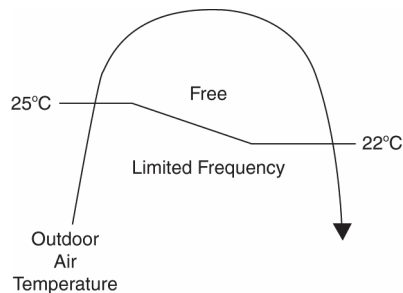

15.2.2 Cooling Overload Control

- Detects the Outdoor pipe temperature and carry out below restriction/limitation (Limit the compressor Operation frequency).
- The compressor stop if outdoor pipe temperature exceeds 60°C.
- If the compressor stops 4 times in 20 minutes, Timer LED blinking (F95 indicated: outdoor high pressure rise protection).

15.2.3 Freeze Prevention Control 1

- When indoor heat exchanger temperature is lower than 0°C continuously for 6 minutes, compressor will stop operating.
- Compressor will resume its operation 3 minutes after the indoor heat exchanger is higher than 5°C.
- At the same time, indoor fan speed will be higher than during its normal operation.
- If indoor heat exchanger temperature is higher than 5°C for 5 minutes, the fan speed will return to its normal operation.

15.2.4 Freeze Prevention Control 2

- Control start conditions
 - During Cooling operation and soft dry operation
 - During thermo OFF condition, indoor intake temperature is less than 10°C or
 - Compressor stops for freeze prevention control
 - Either one of the conditions above occurs 5 times in 60 minutes.
- Control contents
 - Operation stops
 - Timer LED blinks and “H99” indicated

15.2.5 Dew Prevention Control 1

- To prevent dew formation at indoor unit discharge area.
- This control will be activated if:
 - Outdoor air temperature and Indoor pipe temperature judgment by microcontroller is fulfilled.
 - When Cooling or Dry mode is operated more than 20 minutes or more.
- This control stopped if:
 - Compressor stopped.
 - Remote control setting changed (fan speed / temperature).
 - Outdoor air temperature and indoor intake temperature changed.
- Fan speed will be adjusted accordingly in this control.

15.2.6 Odor Cut Control

- To reduce the odor released from the unit.
 - Start Condition
 - AUTO FAN Speed is selected during COOL or DRY operation.
 - During freeze prevention control and timer preliminary operation, this control is not applicable.
 - Control content
 - Depends on compressor conditions:
 1. Compressor OFF → Compressor ON.
The indoor unit fan stops temporarily and then starts to blow at minimum airflow for 30 seconds.
 2. Compressor ON → Compressor OFF.
The indoor unit fan stops for 90 seconds and then blows at minimum airflow for 20 seconds.

15.3 Protection Control for Heating Operation

15.3.1 Intake Air Temperature Control

Compressor will operate at limited freq., if indoor intake air temperature is 30°C or above.

15.3.2 Outdoor Air Temperature Control

- The Max current value is regulated when the outdoor air temperature rise above 14°C in order to avoid compressor overloading.

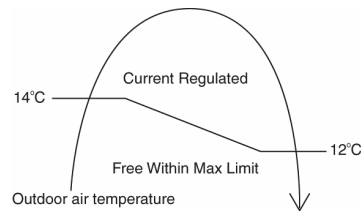

15.3.3 Overload Protection Control

- The compressor operating frequency is regulated in accordance to indoor heat exchanger temperature as shown below.
- If the heat exchanger temperature exceeds 60°C, compressor will stop.

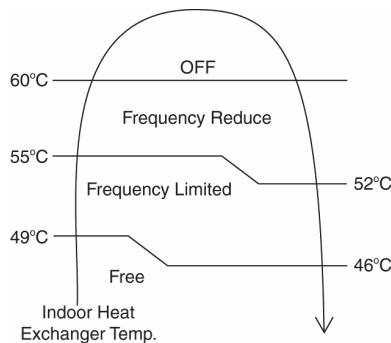

15.3.4 Cold Draught Prevention Control

- When indoor pipe temperature is low, cold draught operation starts where indoor fan speed will be reduced.

15.3.5 Deice Operation

- When outdoor pipe temperature and outdoor air temperature is low, deice operation start where indoor fan motor and outdoor fan motor stop and Deice LED ON.

16. Servicing Mode

16.1 Auto OFF/ON Button

16.1.1 Mode setting by Emergency SW

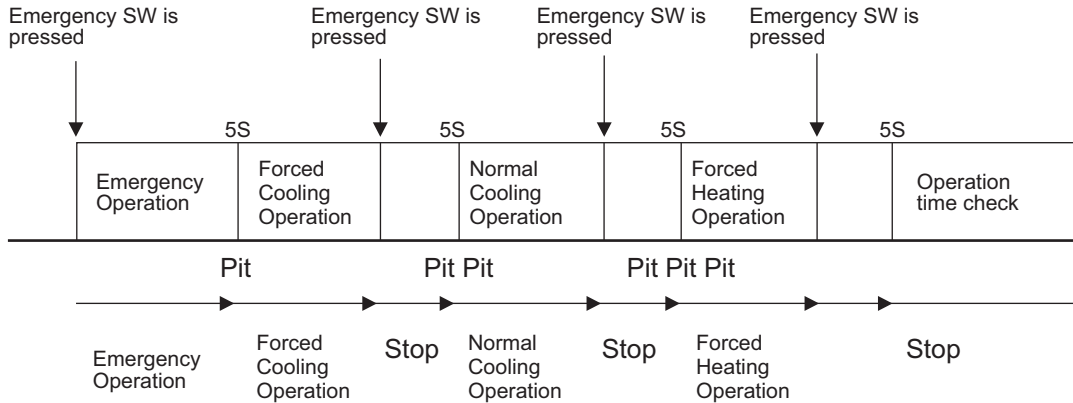

- Emergency Operation (Auto Operation) will begin immediately when the Emergency SW is pressed and released within 5 seconds.
- The unit will enter into Forced Cooling Operation if the Emergency SW is pressed, and held for at least 5 seconds before releasing (Code receiving sound - pit).
- The unit will enter into Normal Cooling Operation if the Emergency SW is pressed, and held for at least 5 seconds before releasing within 5 minutes after Force Cooling Operation begins (Code receiving sound - pit pit).
- The unit will enter into Forced Heating Operation if the Emergency SW is pressed, and held for at least 5 seconds before releasing within 5 minutes after Normal Cooling Operation begins (Code receiving sound - pit pit pit).
- The unit will enter into Operation Time Check Mode if the Emergency SW is pressed, and held for at least 5 seconds before releasing within 5 minutes after Force Heating Operation begins (Code receiving sound - peet).
- The unit will enter into Forced Cooling Operation again if the Emergency SW is pressed, and held for at least 5 seconds before releasing within 5 minutes after Operation Time Check Mode begins.
- All modes will be cancelled when it receives any remocon code.

1 AUTO OPERATION MODE

The Auto operation will be activated immediately once the Auto OFF/ON button is pressed. This operation can be used to operate air conditioner with limited function if remote control is misplaced or malfunction.

2 TEST RUN OPERATION (FOR PUMP DOWN/SERVICING PURPOSE)

The Test Run operation will be activated if the Auto OFF/ON button is pressed continuously for more than 5 seconds. A “beep” sound will heard at the fifth seconds, in order to identify the starting of Test Run operation (Forced cooling operation). Within 5 minutes after Forced cooling operation start, the Auto OFF/ON button is pressed for more than 5 seconds. A 2 “beep” sounds will heard at the fifth seconds, in order to identify the starting of Forced heating operation.

The Auto OFF/ON button may be used together with remote control to set / change the advance setting of air conditioner operation.

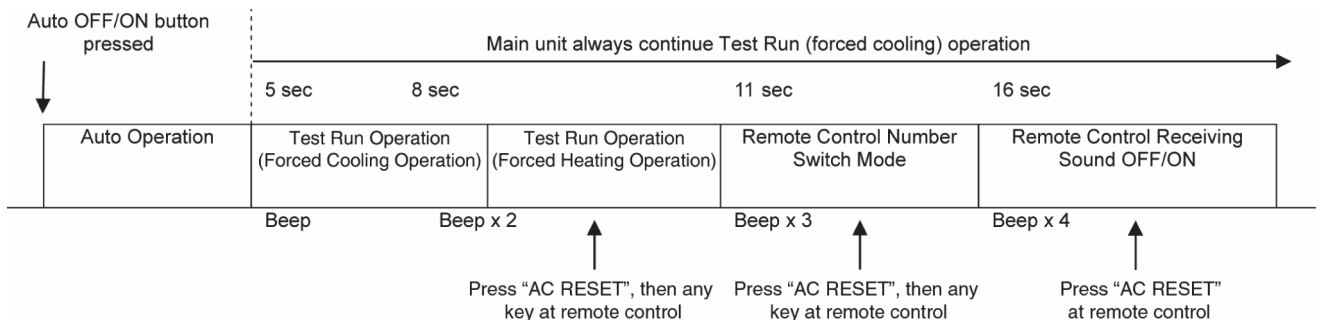

3 REMOTE CONTROL NUMBER SWITCH MODE

The Remote Control Number Switch Mode will be activated if the Auto OFF/ON button is pressed continuously for more than 11 seconds (3 “beep” sounds will occur at 11th seconds to identify the Remote Control Number Switch Mode is in standby condition) and press “AC RESET” button and then press any button at remote control to transmit and store the desired transmission code to the EEPROM.

There are 4 types of remote control transmission code could be selected and stored in EEPROM of indoor unit. The indoor unit will only operate when received signal with same transmission code from remote control. This could prevent signal interference when there are 2 or more indoor units installed nearby together. To change remote control transmission code, short or open jumpers at the remote control printed circuit board.

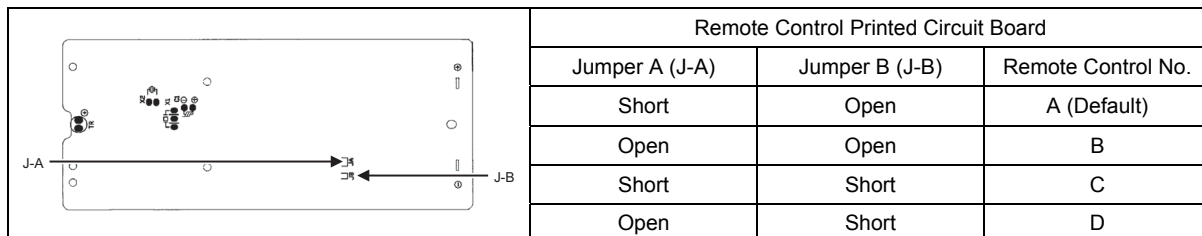

- During Remote Control Number Switch Mode, press any button at remote control to transmit and store the transmission code to the EEPROM.

4 REMOTE CONTROL RECEIVING SOUND OFF/ON MODE

The Remote Control Receiving Sound OFF/ON Mode will be activated if the Auto OFF/ON button is pressed continuously for more than 16 seconds (4 “beep” sounds will occur at 16th seconds to identify the Remote Control Receiving Sound Off/On Mode is in standby condition) and press “AC Reset” button at remote control.

Press “Auto OFF/ON button” to toggle remote control receiving sound.

- Short “beep”: Turn OFF remote control receiving sound.
- Long “beep”: Turn ON remote control receiving sound.

After Auto OFF/ON Button is pressed, the 20 seconds counter for Remote Control Receiving Sound OFF/ON Mode is restarted.

16.2 Remote Control Button

16.2.1 SET Button

- To check remote control transmission code and store the transmission code to EEPROM:
 - Press “Set” button by using pointer.
 - Press “Timer Set” button until a “beep” sound is heard as confirmation of transmission code changed.
- To limit set temperature range for COOL & DRY, HEAT mode.
 - Press “Set” button by using pointer.
 - Press TEMP increment or decrement button to choose No. 3.
 - Press Timer increment or decrement button to select desired temperature low limit of set temperature for COOL & DRY mode.
 - Press Timer Set button to confirm low limit selection.
 - Press TEMP increment or decrement button to choose No. 4.
 - Press Timer decrement or increment button to select desired temperature high limit of set temperature for COOL & DRY mode.
 - Press Timer Set button to confirm high limit selection.
 - Press TEMP increment or decrement button to choose No. 5.
 - Press Timer increment or decrement button to select desired temperature low limit of set temperature for HEAT mode.
 - Press Timer Set button to confirm low limit selection.
 - Press TEMP increment or decrement button to choose No. 6.
 - Press Timer decrement or increment button to select desired temperature high limit of set temperature for HEAT mode.
 - Press Timer Set button to confirm high limit selection.
 - LCD returns to original display if remote control does not operate for 30 seconds or press Timer Cancel button.

- Auto restart enable/disable selection

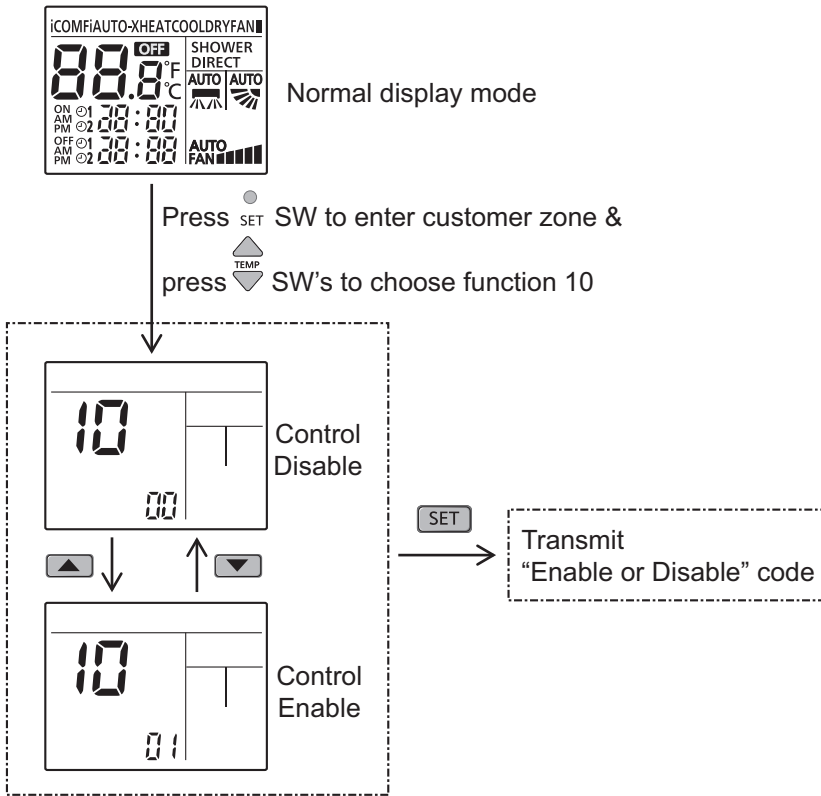

- 1 Press CANCEL SW, special setting is immediately cancelled and normal mode starts.
- 2 If no SW is pressed for 30secs, then special setting mode is cancelled and normal mode starts.
- 3 Under this function, only TEMP, ▲, ▼, SET, CANCEL & RC RESET SW's are effective.

Note:
By default is enable.

- New Deice Judgement Selection

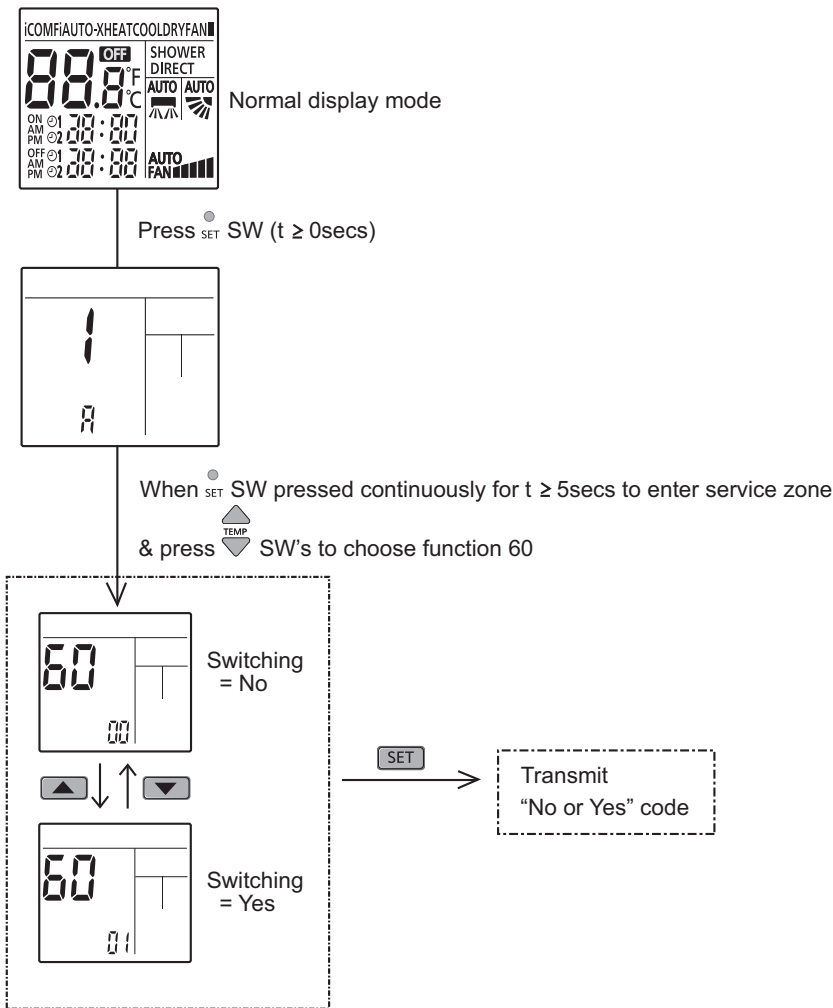

Note:

By default is New Deice Judgement.

16.2.2 RESET (RC)

- To clear and restore the remote control setting to factory default.
 - Press once to clear the memory.

16.2.3 RESET (AC)

- To restore the unit's setting to factory default.
 - Press once to restore the unit's setting.

16.2.4 TIMER ▲

- To change indoor unit indicator's LED intensity.
 - Press continuously for 5 seconds.

16.2.5 TIMER ▼

- To change remote control display from Degree Celsius (°C) to Degree Fahrenheit (°F).
 - Press continuously for 10 seconds.

17. Troubleshooting Guide

17.1 Refrigeration Cycle System

In order to diagnose malfunctions, make sure that there are no electrical problems before inspecting the refrigeration cycle. Such problems include insufficient insulation, problem with the power source, malfunction of a compressor and a fan. The normal outlet air temperature and pressure of the refrigeration cycle depends on various conditions, the standard values for them are shown in the table on the right.

Normal Pressure and Outlet Air Temperature (Standard)

	Gas Pressure MPa (kg/cm ² G)	Outlet air Temperature (°C)
Cooling Mode	0.9 ~ 1.2 (9 ~ 12)	13 ~ 17
Heating Mode	2.0 ~ 2.7 (20 ~ 27)	32 ~ 42

- *Condition:
- Indoor fan speed = High
 - Outdoor temperature 35°C at the cooling mode and 7°C at the heating mode
 - Compressor operates at rated frequency

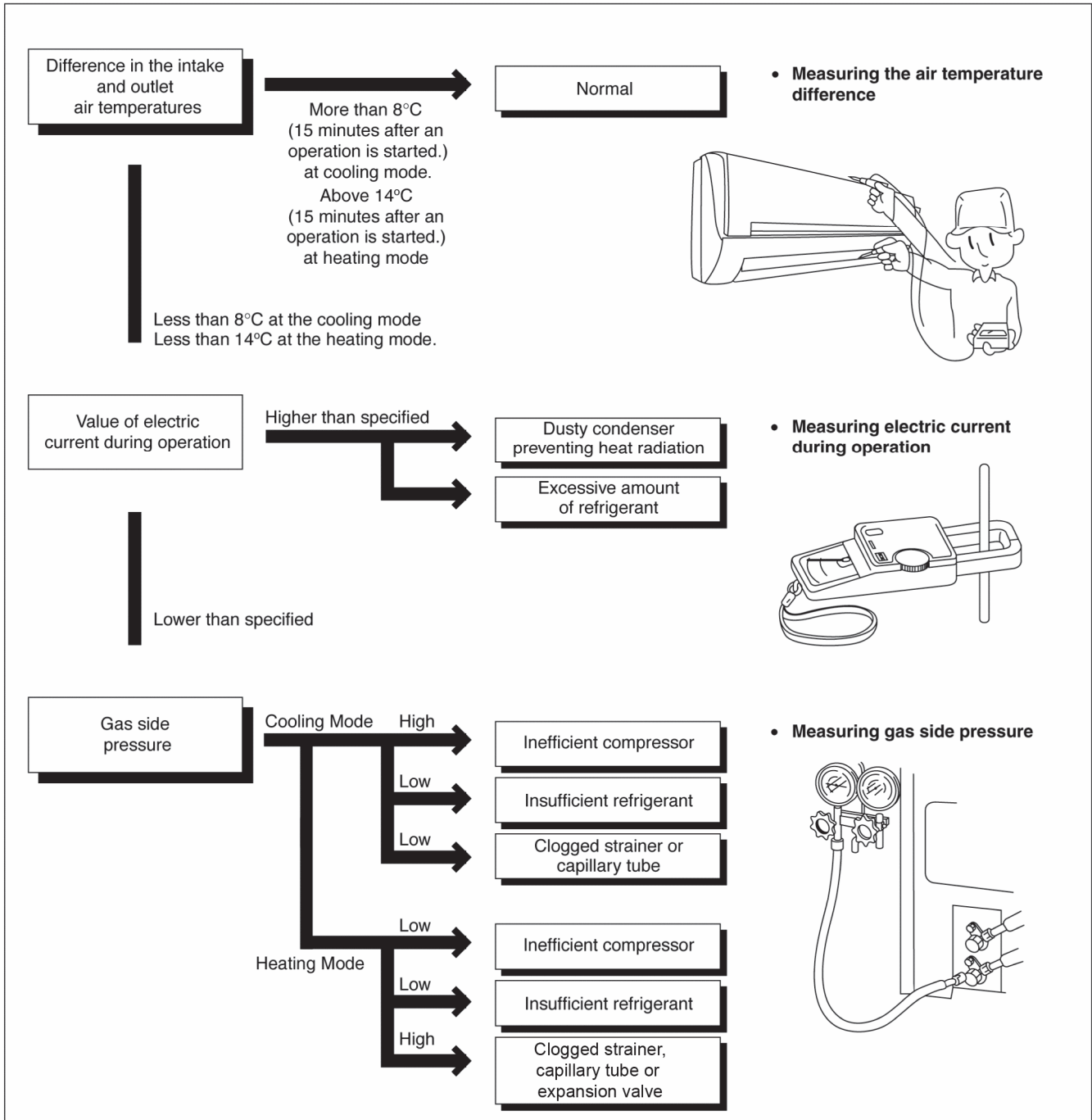

17.1.1 Relationship Between the Condition of the Air Conditioner and Pressure and Electric Current

Condition of the air conditioner	Cooling Mode			Heating Mode		
	Low Pressure	High Pressure	Electric current during operation	Low Pressure	High Pressure	Electric current during operation
Insufficient refrigerant (gas leakage)	↘	↘	↘	↘	↘	↘
Clogged capillary tube or Strainer	↘	↘	↘	↗	↗	↗
Short circuit in the indoor unit	↘	↘	↘	↗	↗	↗
Heat radiation deficiency of the outdoor unit	↗	↗	↗	↘	↘	↘
Inefficient compression	↗	↘	↘	↗	↘	↘

- Carry out the measurement of pressure, electric current, and temperature fifteen minutes after an operation is started.

17.2 Breakdown Self Diagnosis Function

17.2.1 Self Diagnosis Function (Three Digits Alphanumeric Code)

- Once abnormality has occurred during operation, the unit will stop its operation, and Timer LED blinks.
 - Although Timer LED goes off when power supply is turned off, if the unit is operated under a breakdown condition, the LED will light up again.
 - In operation after breakdown repair, the Timer LED will no more blink. The last error code (abnormality) will be stored in IC memory.
- 6 When the latest abnormality code on the main unit and code transmitted from the remote controller are matched, power LED will light up for 30 seconds and a beep sound (continuously for 4 seconds) will be heard. If no codes are matched, power LED will light up for 0.5 seconds and no sound will be heard.
 - 7 The breakdown diagnosis mode will be canceled unless pressing the CHECK button continuously for 5 seconds or operating the unit for 30 seconds.
 - 8 The same diagnosis can be repeated by turning power on again.

17.2.2 To Make a Diagnosis

- 1 Timer LED start to blink and the unit automatically stops the operation.
- 2 Press the CHECK button on the remote controller continuously for 5 seconds.
- 3 “- -” will be displayed on the remote controller display.
Note: Display only for “- -”. (No transmitting signal, no receiving sound and no Power LED blinking.)
- 4 Press the “TIMER” ▲ or ▼ button on the remote controller. The code “H00” (no abnormality) will be displayed and signal will be transmitted to the main unit.
- 5 Every press of the button (up or down) will increase abnormality numbers and transmit abnormality code signal to the main unit.
- 6 When the latest abnormality code on the main unit and code transmitted from the remote controller are matched, power LED will light up for 30 seconds and a beep sound (continuously for 4 seconds) will be heard. If no codes are matched, power LED will light up for 0.5 seconds and no sound will be heard.
- 7 The breakdown diagnosis mode will be canceled unless pressing the CHECK button continuously for 5 seconds or operating the unit for 30 seconds.
- 8 The LED will be off if the unit is turned off or the RESET button on the main unit is pressed.

17.2.3 To Display Memorized Error Code (Protective Operation)

- 1 Turn power on.
- 2 Press the CHECK button on the remote controller continuously for 5 seconds.
- 3 “- -” will be displayed on the remote controller display.
Note: Display only for “- -”. (No transmitting signal, no receiving sound and no Power LED blinking.)
- 4 Press the “TIMER” ▲ or ▼ button on the remote controller. The code “H00” (no abnormality) will be displayed and signal will be transmitted to the main unit. The power LED lights up. If no abnormality is stored in the memory, three beeps sound will be heard.
- 5 Every press of the button (up or down) will increase abnormality numbers and transmit abnormality code signal to the main unit.

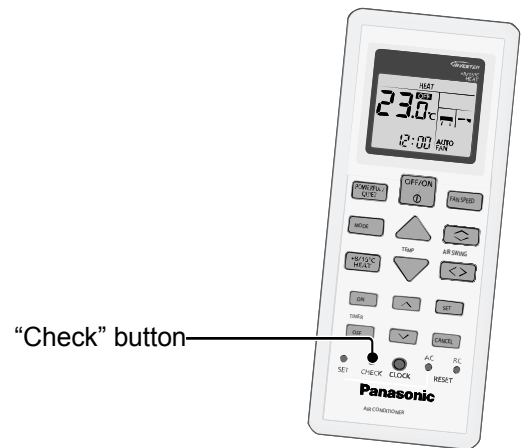

17.2.4 To Clear Memorized Error Code after Repair (Protective Operation)

- 1 Turn power on (in standby condition).
- 2 Press the AUTO button for 5 seconds (A beep receiving sound) on the main unit to operate the unit at Forced Cooling Operation modes.
- 3 Press the CHECK button on the remote controller for about 1 second with a pointed object to transmit signal to main unit. A beep sound is heard from main unit and the data is cleared.

17.2.5 Temporary Operation (Depending On Breakdown Status)

- 1 Press the AUTO button (A beep receiving sound) on the main unit to operate the unit. (Remote control will become possible.)
- 2 The unit can temporarily be used until repaired.

17.3 Error Codes Table

Diagnosis display	Abnormality / Protection control	Abnormality Judgment	Protection Operation	Problem	Check location
H00	No memory of failure	—	Normal operation	—	—
H11	Indoor/outdoor abnormal communication	After operation for 1 minute	Indoor fan only operation can start by entering into force cooling operation	Indoor/outdoor communication not establish	<ul style="list-style-type: none"> Indoor/outdoor wire terminal Indoor/outdoor PCB Indoor/outdoor connection wire
H12	Indoor unit capacity unmatched	90s after power supply	—	Total indoor capability more than maximum limit or less than minimum limit, or number of indoor unit less than two	<ul style="list-style-type: none"> Indoor/outdoor connection wire Indoor/outdoor PCB Specification and combination table in catalogue
H14	Indoor intake air temperature sensor abnormality	Continuous for 5s	—	Indoor intake air temperature sensor open or short circuit	<ul style="list-style-type: none"> Indoor intake air temperature sensor lead wire and connector
H15	Compressor temperature sensor abnormality	Continuous for 5s	—	Compressor temperature sensor open or short circuit	<ul style="list-style-type: none"> Compressor temperature sensor lead wire and connector
H16	Outdoor current transformer (CT) abnormality	—	—	Current transformer faulty or compressor faulty	<ul style="list-style-type: none"> Outdoor PCB faulty or compressor faulty
H19	Indoor fan motor mechanism lock	Continuous happen for 7 times	—	Indoor fan motor lock or feedback abnormal	<ul style="list-style-type: none"> Fan motor lead wire and connector Fan motor lock or block
H23	Indoor heat exchanger temperature sensor abnormality	Continuous for 5s	—	Indoor heat exchanger temperature sensor open or short circuit	<ul style="list-style-type: none"> Indoor heat exchanger temperature sensor lead wire and connector
H24	Indoor heat exchanger temperature sensor 2 abnormality	Continuous for 5s	—	Indoor heat exchanger temperature sensor 2 open or short circuit	<ul style="list-style-type: none"> Indoor heat exchanger temperature sensor 2 lead wire and connector
H25	Indoor ion device abnormality	Port is ON for 10s during ion device off	—	—	<ul style="list-style-type: none"> ion device PCB
H27	Outdoor air temperature sensor abnormality	Continuous for 5s	—	Outdoor air temperature sensor open or short circuit	<ul style="list-style-type: none"> Outdoor air temperature sensor lead wire and connector
H28	Outdoor heat exchanger temperature sensor 1 abnormality	Continuous for 5s	—	Outdoor heat exchanger temperature sensor 1 open or short circuit	<ul style="list-style-type: none"> Outdoor heat exchanger temperature sensor 1 lead wire and connector
H30	Outdoor discharge pipe temperature sensor abnormality	Continuous for 5s	—	Outdoor discharge pipe temperature sensor open or short circuit	<ul style="list-style-type: none"> Outdoor discharge pipe temperature sensor lead wire and connector
H32	Outdoor heat exchanger temperature sensor 2 abnormality	Continuous for 5s	—	Outdoor heat exchanger temperature sensor 2 open or short circuit	<ul style="list-style-type: none"> Outdoor heat exchanger temperature sensor 2 lead wire and connector
H33	Indoor / outdoor misconnection abnormality	—	—	Indoor and outdoor rated voltage different	<ul style="list-style-type: none"> Indoor and outdoor units check
H34	Outdoor heat sink temperature sensor abnormality	Continuous for 2s	—	Outdoor heat sink temperature sensor open or short circuit	<ul style="list-style-type: none"> Outdoor heat sink sensor
H36	Outdoor gas pipe temperature sensor abnormality	Continuous for 5s	Heating protection operation only	Outdoor gas pipe temperature sensor open or short circuit	<ul style="list-style-type: none"> Outdoor gas pipe temperature sensor lead wire and connector
H37	Outdoor liquid pipe temperature sensor abnormality	Continuous for 5s	Cooling protection operation only	Outdoor liquid pipe temperature sensor open or short circuit	<ul style="list-style-type: none"> Outdoor liquid pipe temperature sensor lead wire and connector
H38	Indoor/Outdoor mismatch (brand code)	—	—	Brand code not match	<ul style="list-style-type: none"> Check indoor unit and outdoor unit
H39	Abnormal indoor operating unit or standby units	3 times happen within 40 minutes	—	Wrong wiring and connecting pipe, expansion valve abnormality, indoor heat exchanger sensor open circuit	<ul style="list-style-type: none"> Check indoor/outdoor connection wire and connection pipe Indoor heat exchanger sensor lead wire and connector Expansion valve and lead wire and connector

Diagnosis display	Abnormality / Protection control	Abnormality Judgment	Protection Operation	Problem	Check location
H41	Abnormal wiring or piping connection	—	—	Wrong wiring and connecting pipe, expansion valve abnormality	<ul style="list-style-type: none"> • Check indoor/outdoor connection wire and connection pipe • Expansion valve and lead wire and connector
H59	ECONAVI sensor abnormality	Continuous for 25s	—	ECONAVI sensor open or short circuit	<ul style="list-style-type: none"> • ECONAVI sensor (defective or disconnected) • ECONAVI PCB
H64	Outdoor high pressure sensor abnormality	Continuous for 1 minutes	—	High pressure sensor open circuit during compressor stop	<ul style="list-style-type: none"> • High pressure sensor • Lead wire and connector
H67	Nanoe abnormality	Nanoe stop for 5 minutes for 3 times	—	Nanoe faulty	<ul style="list-style-type: none"> • PCB • Nanoe system • High voltage
H70	Light sensor abnormality	Continuous for 24 hours, 15 days	—	Light sensor open or short circuit	<ul style="list-style-type: none"> • Light sensor (defective or disconnect)
H97	Outdoor fan motor mechanism lock	2 times happen within 30 minutes	—	Outdoor fan motor lock or feedback abnormal	<ul style="list-style-type: none"> • Outdoor fan motor lead wire and connector • Fan motor lock or block
H98	Indoor high pressure protection	—	—	Indoor high pressure protection (Heating)	<ul style="list-style-type: none"> • Check indoor heat exchanger • Air filter dirty • Air circulation short circuit
H99	Indoor operating unit freeze protection	—	—	Indoor freeze protection (Cooling)	<ul style="list-style-type: none"> • Check indoor heat exchanger • Air filter dirty • Air circulation short circuit
F11	4-way valve switching abnormality	4 times happen within 30 minutes	—	4-way valve switching abnormal	<ul style="list-style-type: none"> • 4-way valve • Lead wire and connector
F17	Indoor standby units freezing abnormality	3 times happen within 40 minutes	—	Wrong wiring and connecting pipe, expansion valve leakage, indoor heat exchanger sensor open circuit	<ul style="list-style-type: none"> • Check indoor/outdoor connection wire and pipe • Indoor heat exchanger sensor lead wire and connector • Expansion valve lead wire and connector
F90	Power factor correction (PFC) circuit protection	4 times happen within 10 minutes	—	Power factor correction circuit abnormal	<ul style="list-style-type: none"> • Outdoor PCB faulty
F91	Refrigeration cycle abnormality	2 times happen within 20 minutes	—	Refrigeration cycle abnormal	<ul style="list-style-type: none"> • Insufficient refrigerant or valve close
F93	Compressor abnormal revolution	4 times happen within 20 minutes	—	Compressor abnormal revolution	<ul style="list-style-type: none"> • Power transistor module faulty or compressor lock
F94	Compressor discharge overshoot protection	4 times happen within 30 minutes	—	Compressor discharge pressure overshoot	<ul style="list-style-type: none"> • Check refrigeration system
F95	Outdoor cooling high pressure protection	4 times happen within 20 minutes	—	Cooling high pressure protection	<ul style="list-style-type: none"> • Check refrigeration system • Outdoor air circuit
F96	Power transistor module overheating protection	4 times happen within 30 minutes	—	Power transistor module overheat	<ul style="list-style-type: none"> • PCB faulty • Outdoor air circuit (fan motor)
F97	Compressor overheating protection	3 times happen within 30 minutes	—	Compressor overheat	<ul style="list-style-type: none"> • Insufficient refrigerant
F98	Total running current protection	3 times happen within 20 minutes	—	Total current protection	<ul style="list-style-type: none"> • Check refrigeration system • Power source or compressor lock
F99	Outdoor direct current (DC) peak detection	Continuous happen for 7 times	—	Power transistor module current protection	<ul style="list-style-type: none"> • Power transistor module faulty or compressor lock

Note: Some error code may not applicable to this model.

17.4 Self-diagnosis Method

17.4.1 H11 (Indoor/Outdoor Abnormal Communication)

Malfunction Decision Conditions

- During startup and operation of cooling and heating, the data received from outdoor unit in indoor unit signal transmission is checked whether it is normal.

Malfunction Caused

- Faulty indoor unit PCB.
- Faulty outdoor unit PCB.
- Indoor unit-outdoor unit signal transmission error due to wiring error.
- Indoor unit-outdoor unit signal transmission error due to breaking of wire in the connection wires between the indoor and outdoor units.

Troubleshooting

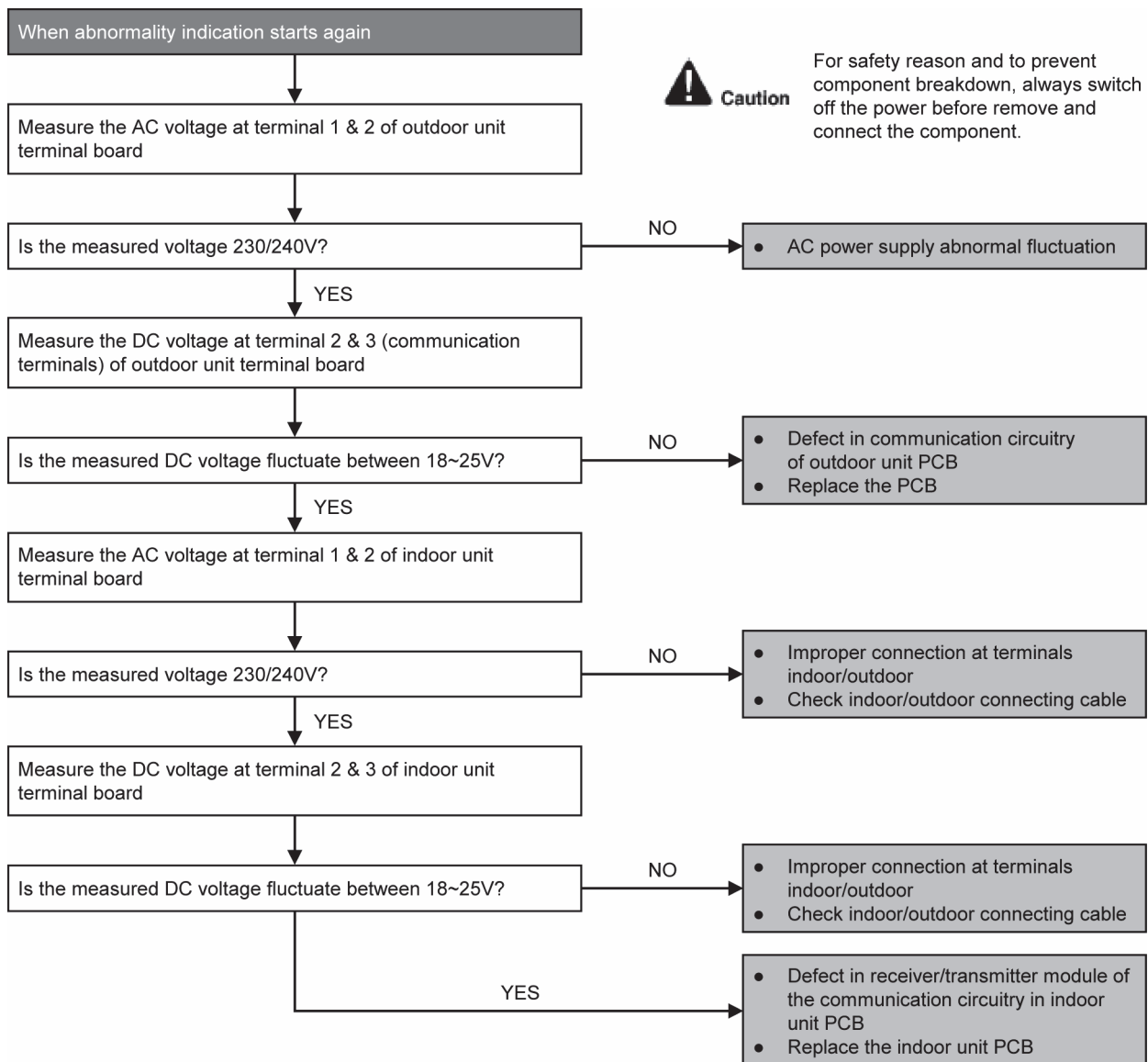

17.4.2 H12 (Indoor/Outdoor Capacity Rank Mismatched)

Malfunction Decision Conditions

- During startup, error code appears when different types of indoor and outdoor units are interconnected.

Malfunction Caused

- Wrong models interconnected.
- Wrong indoor unit or outdoor unit PCBs mounted.
- Indoor unit or outdoor unit PCBs defective.
- Indoor-outdoor unit signal transmission error due to wrong wiring.
- Indoor-outdoor unit signal transmission error due to breaking of wire 3 in the connection wires between the indoor and outdoor units.

Troubleshooting

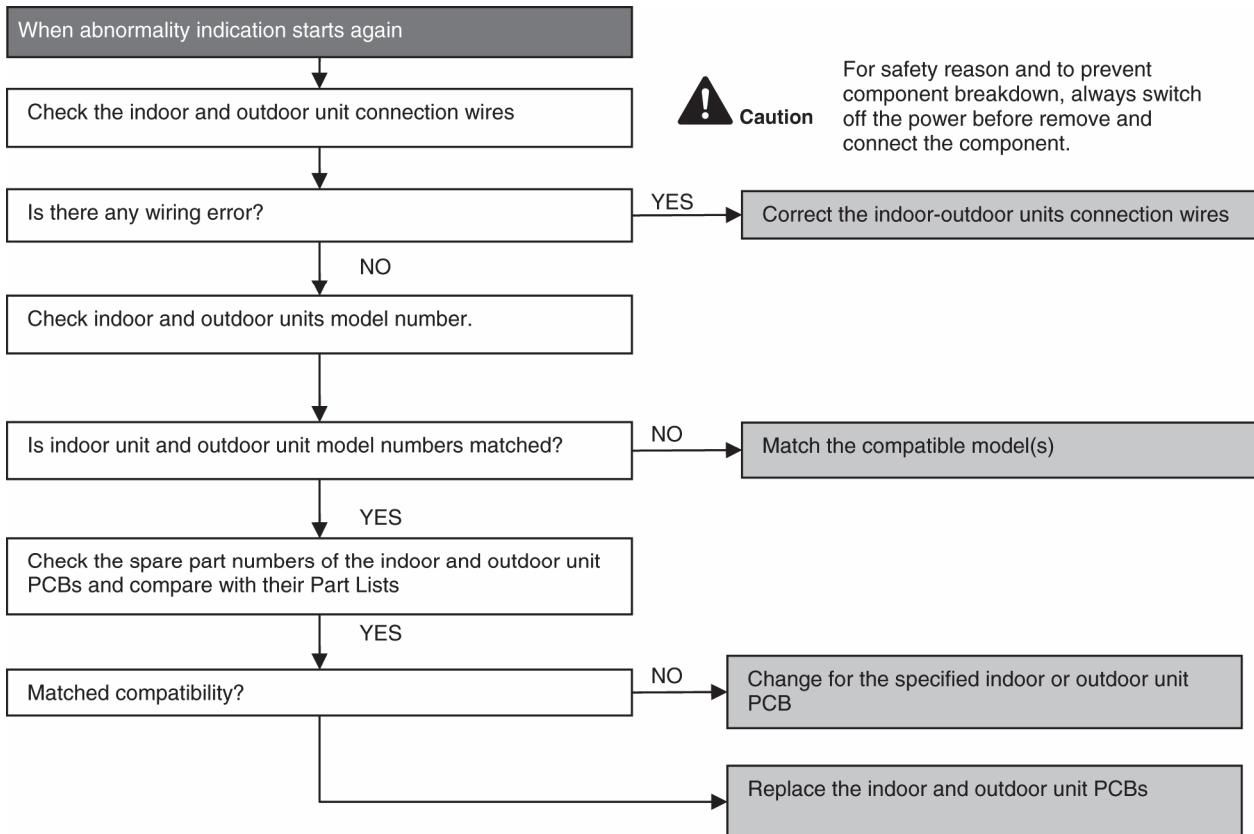

17.4.3 H14 (Indoor Intake Air Temperature Sensor Abnormality)

Malfunction Decision Conditions

- During startup and operation of cooling and heating, the temperatures detected by the indoor intake air temperature sensor are used to determine sensor errors.

Malfunction Caused

- Faulty connector connection.
- Faulty sensor.
- Faulty PCB.

Troubleshooting

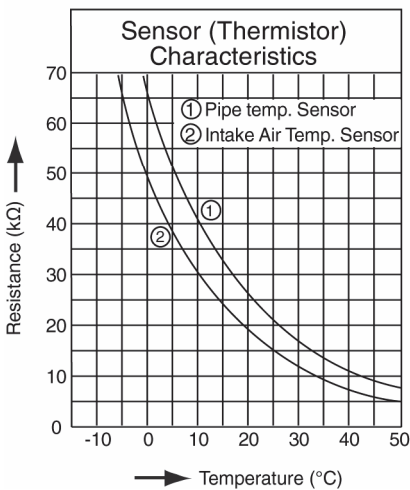
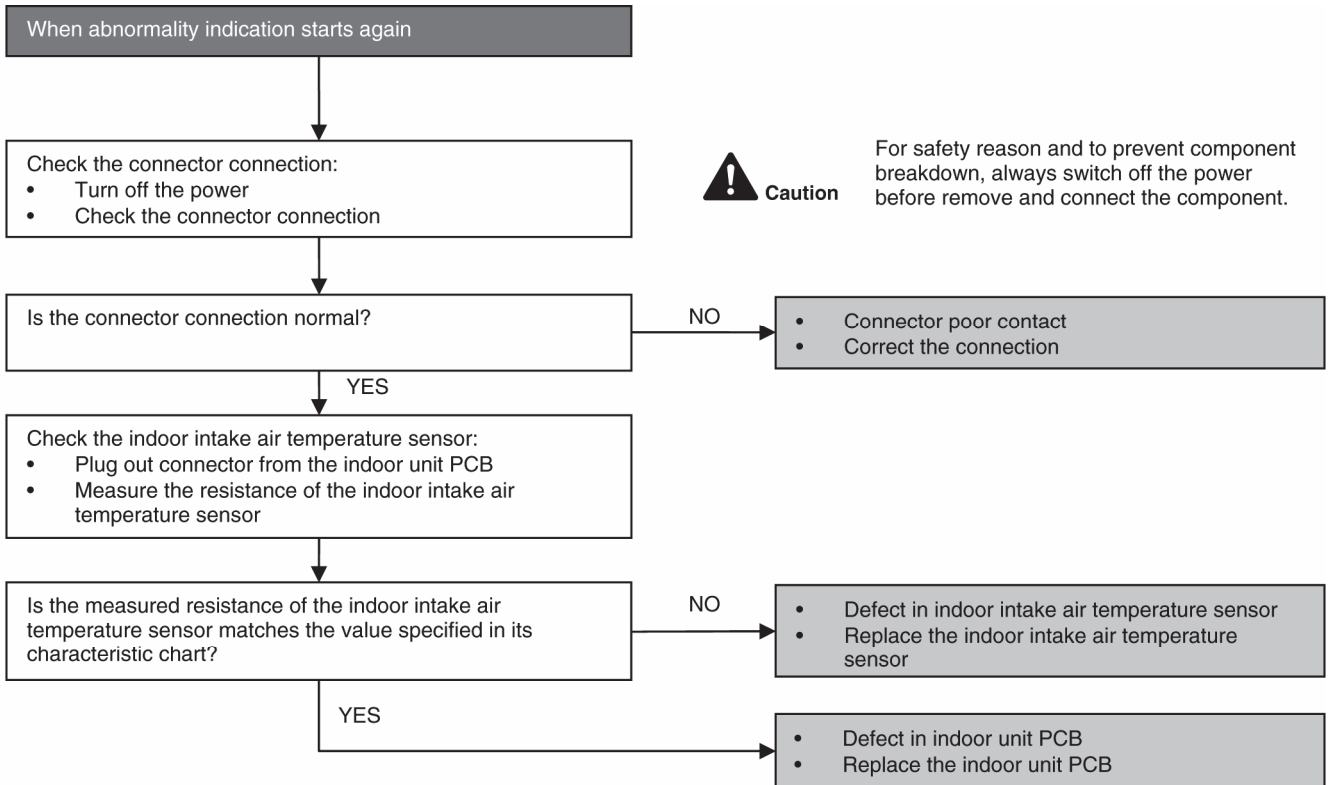

17.4.4 H15 (Compressor Temperature Sensor Abnormality)

Malfunction Decision Conditions

- During startup and operation of cooling and heating, the temperatures detected by the outdoor compressor temperature sensor are used to determine sensor errors.

Malfunction Caused

- Faulty connector connection.
- Faulty sensor.
- Faulty PCB.

Troubleshooting

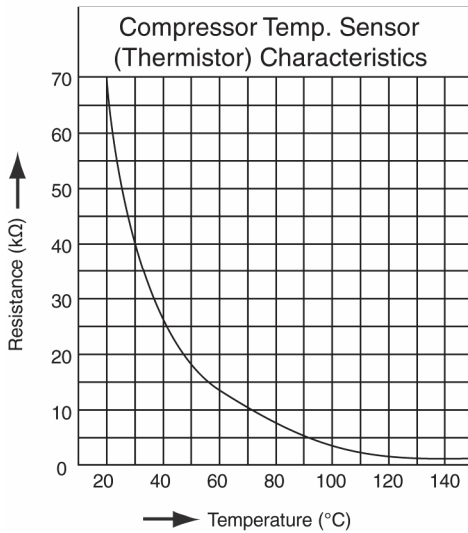
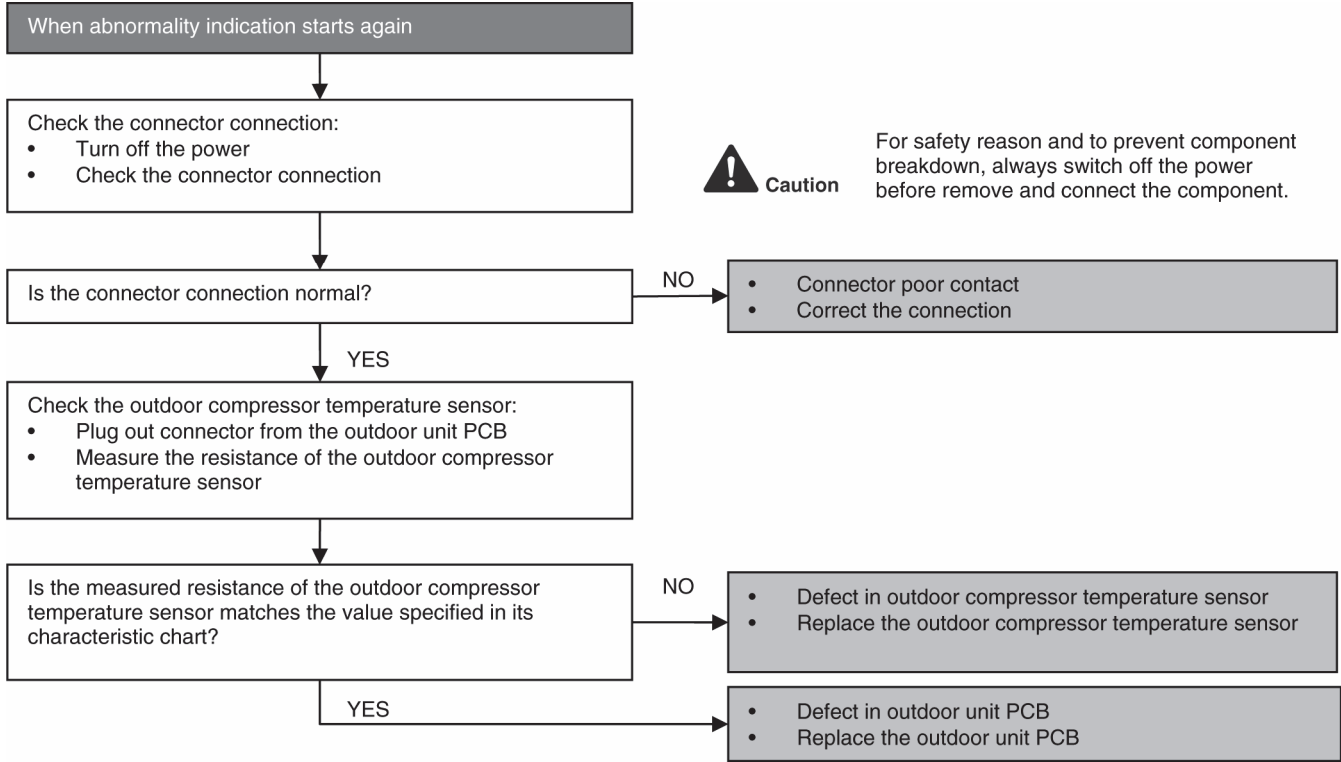

17.4.5 H16 (Outdoor Current Transformer)

Malfunction Decision Conditions

- An input current, detected by Current Transformer CT, is below threshold value when the compressor is operating at certain frequency value for 3 minutes.

Malfunction Caused

- Lack of gas
- Broken CT (current transformer)
- Broken Outdoor PCB

Troubleshooting

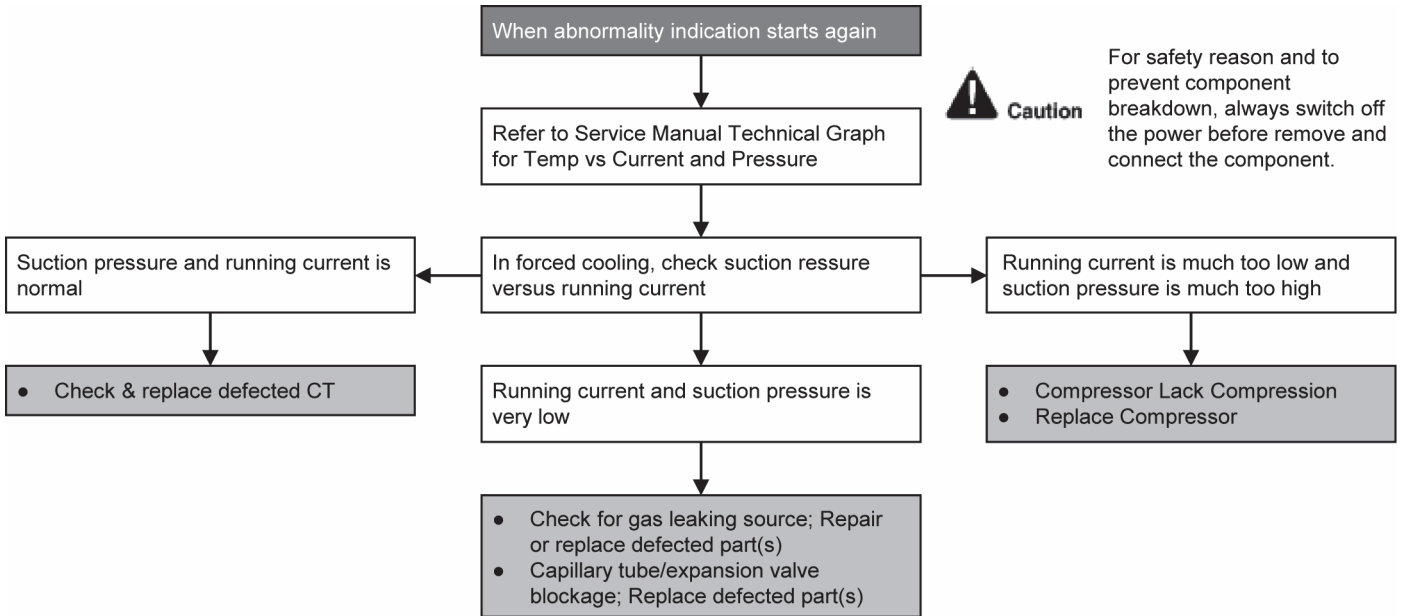

17.4.6 H19 (Indoor Fan Motor – DC Motor Mechanism Locked)

Malfunction Decision Conditions

- The rotation speed detected by the Hall IC during fan motor operation is used to determine abnormal fan motor (feedback of rotation > 2550 rpm or < 50 rpm)

Malfunction Caused

- Operation stops due to short circuit inside the fan motor winding.
- Operation stops due to breaking of wire inside the fan motor.
- Operation stops due to breaking of fan motor lead wires.
- Operation stops due to Hall IC malfunction.
- Operation error due to faulty indoor unit PCB.

Troubleshooting

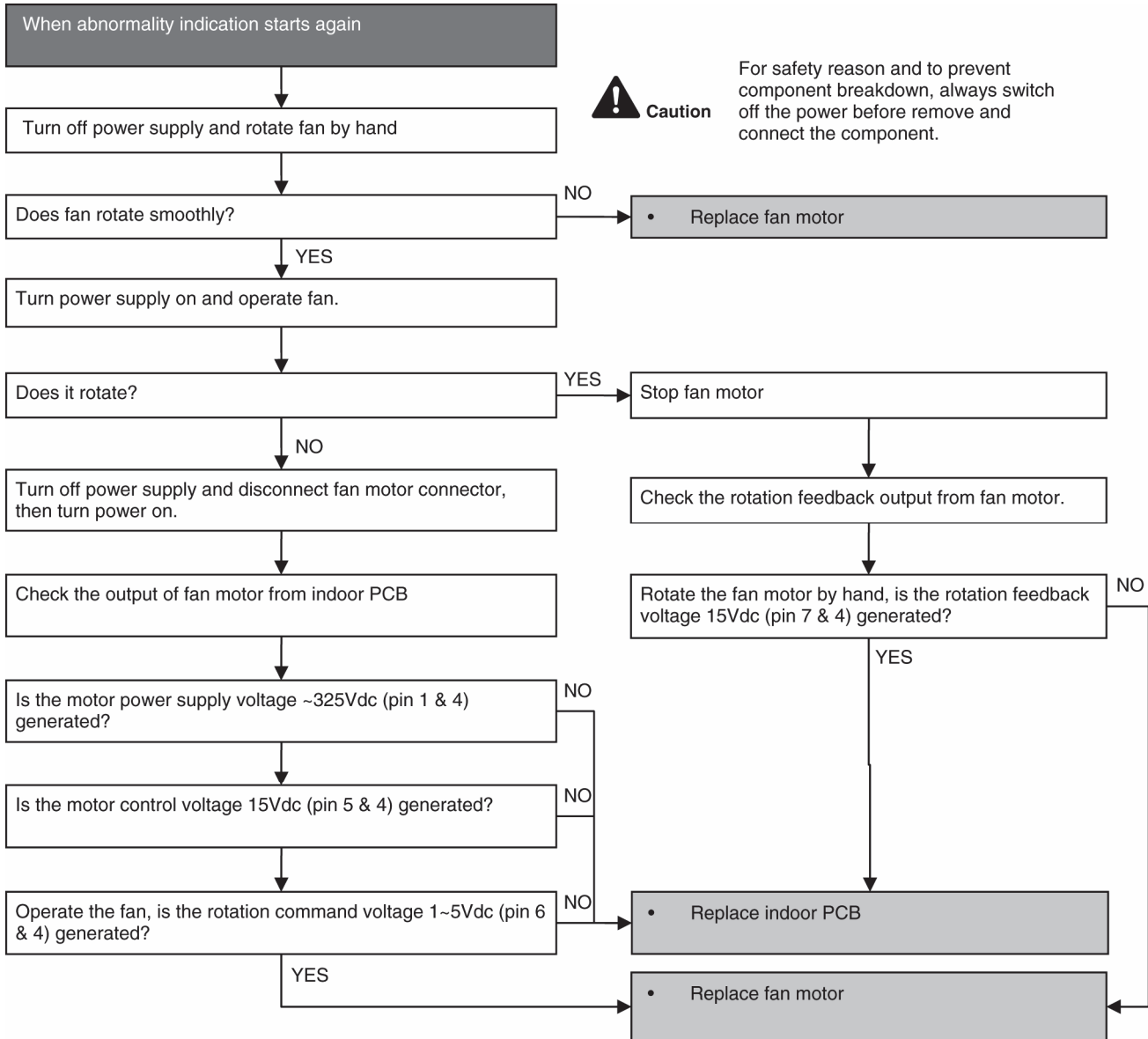

17.4.7 H23 (Indoor Pipe Temperature Sensor Abnormality)

Malfunction Decision Conditions

- During startup and operation of cooling and heating, the temperatures detected by the indoor heat exchanger temperature sensor are used to determine sensor errors.

Malfunction Caused

- Faulty connector connection.
- Faulty sensor.
- Faulty PCB.

Troubleshooting

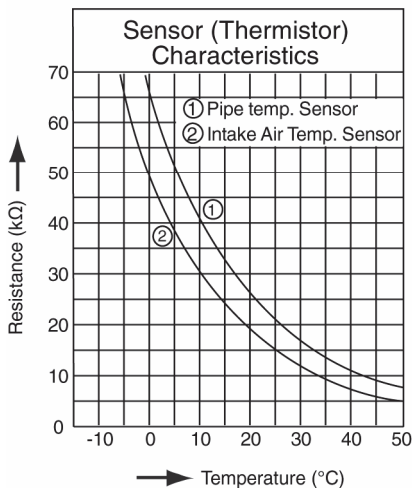
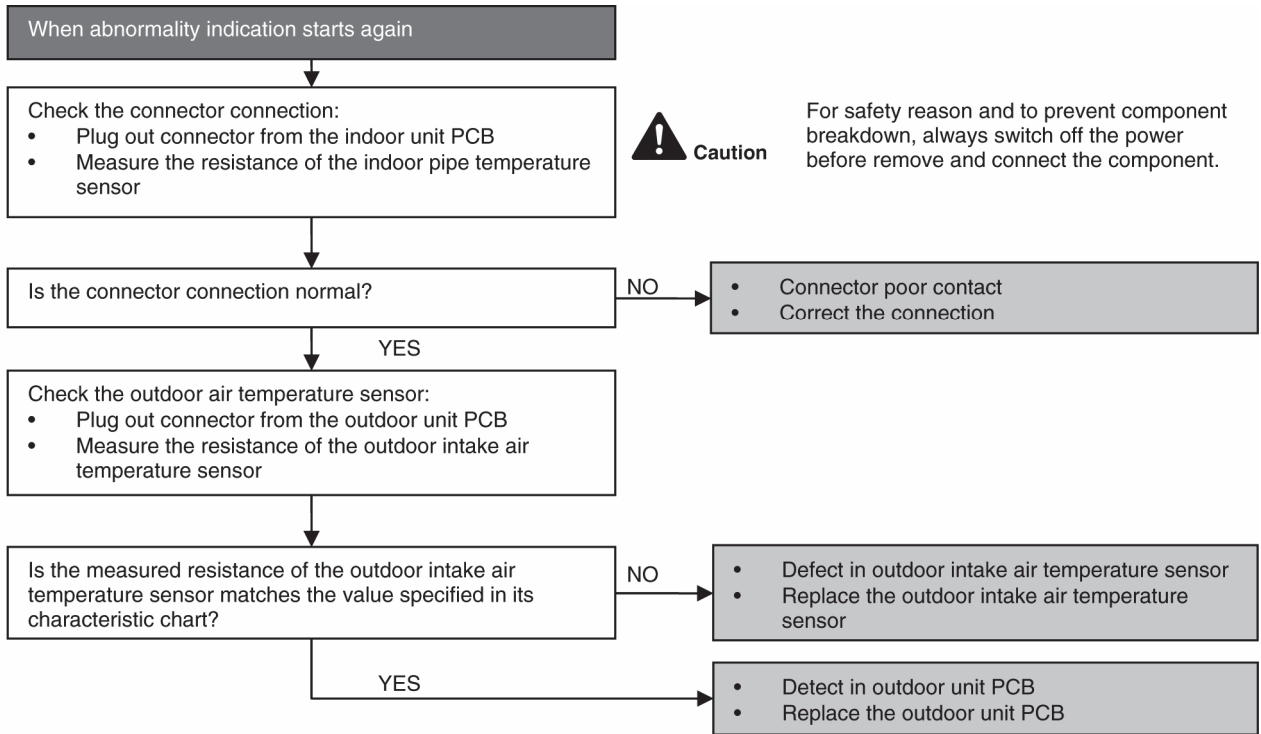

17.4.8 H27 (Outdoor Air Temperature Sensor Abnormality)

Malfunction Decision Conditions

- During startup and operation of cooling and heating, the temperatures detected by the outdoor air temperature sensor are used to determine sensor errors.

Malfunction Caused

- Faulty connector connection.
- Faulty sensor.
- Faulty PCB.

Troubleshooting

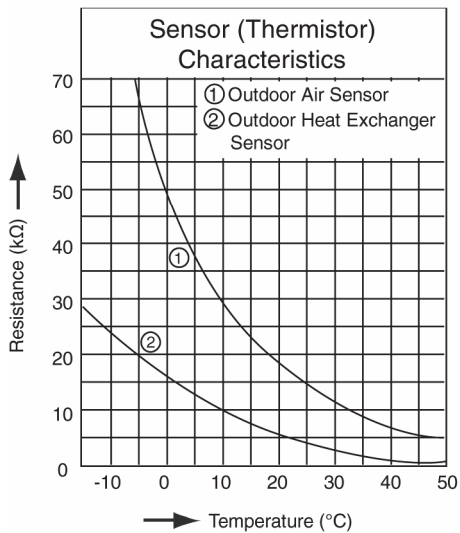
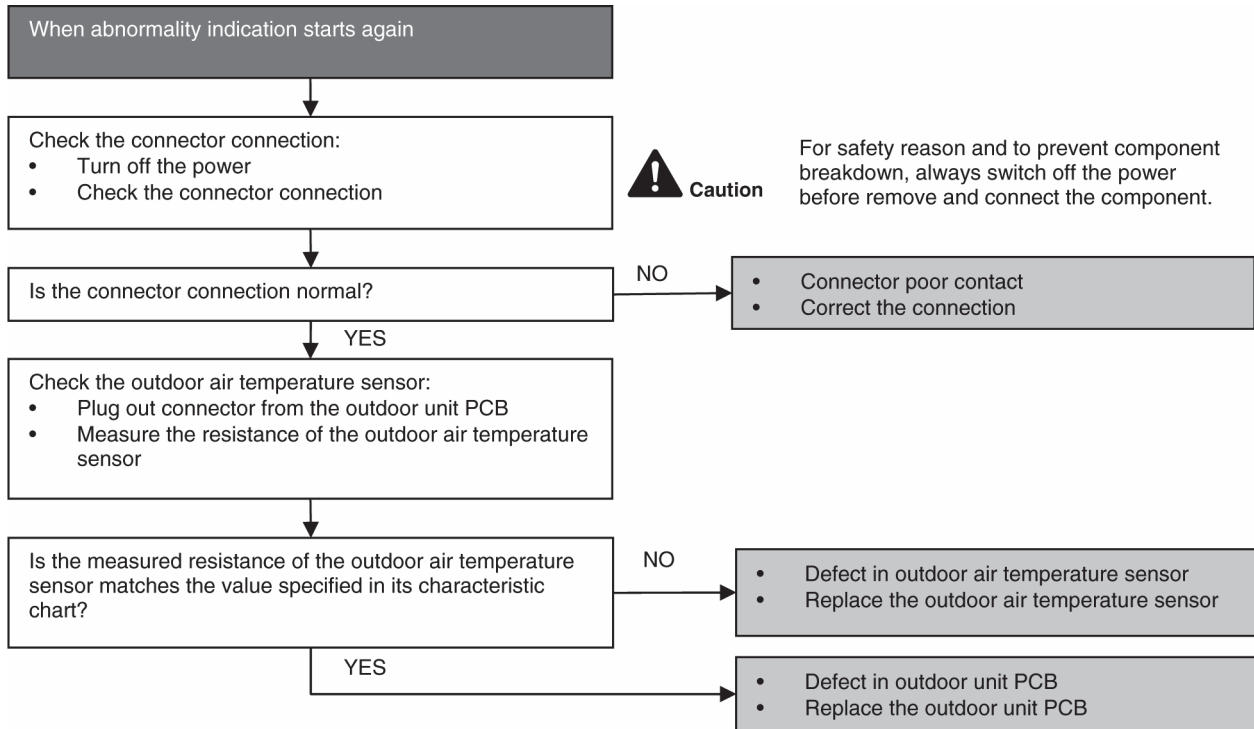

17.4.9 H28 (Outdoor Pipe Temperature Sensor Abnormality)

Malfunction Decision Conditions

- During startup and operation of cooling and heating, the temperatures detected by the outdoor pipe temperature sensor are used to determine sensor errors.

Malfunction Caused

- Faulty connector connection.
- Faulty sensor.
- Faulty PCB.

Troubleshooting

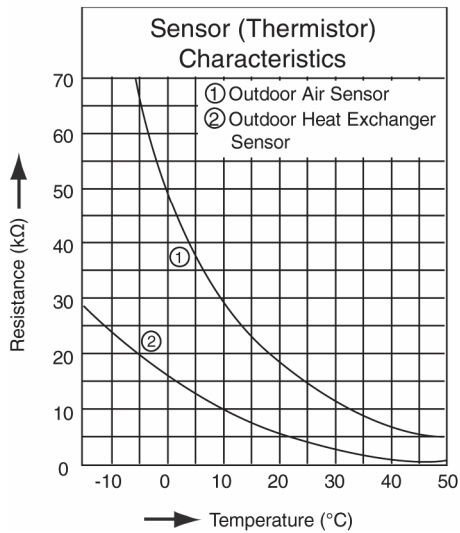
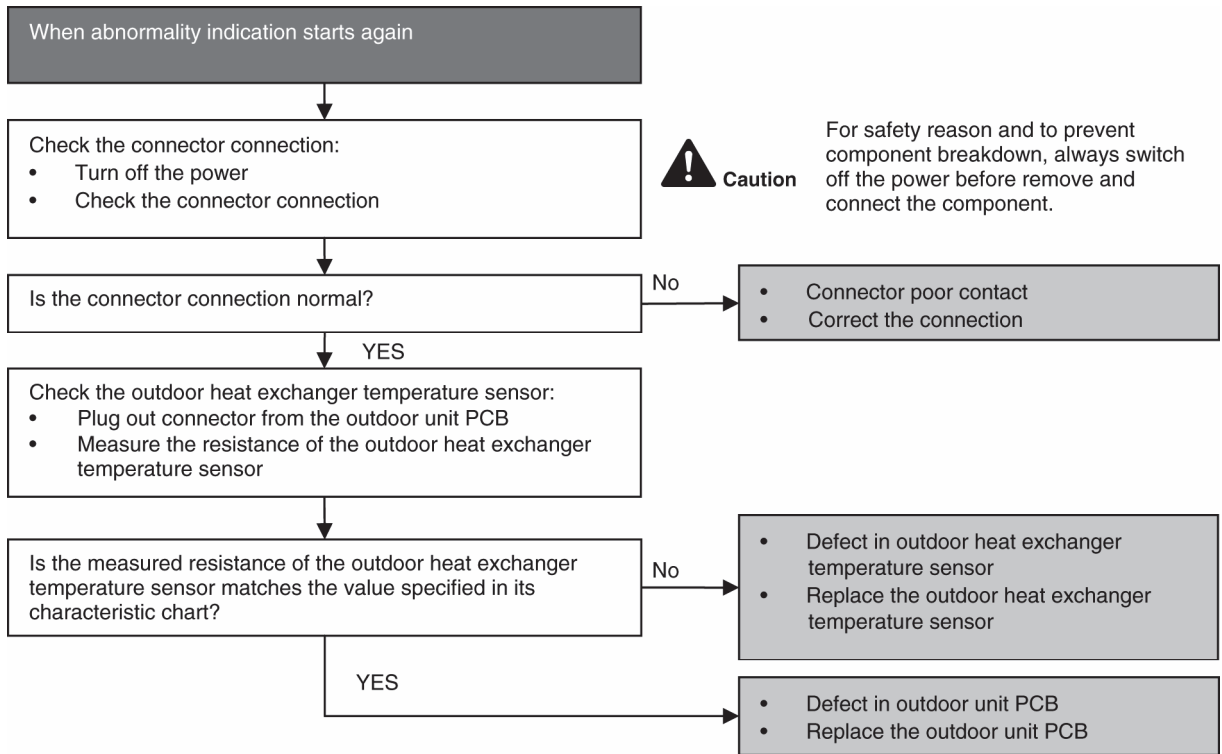

17.4.10 H30 (Compressor Discharge Temperature Sensor Abnormality)

Malfunction Decision Conditions

- During startup and operation of cooling and heating, the temperatures detected by the outdoor discharge pipe temperature sensor are used to determine sensor errors.

Malfunction Caused

- Faulty connector connection.
- Faulty sensor.
- Faulty PCB.

Troubleshooting

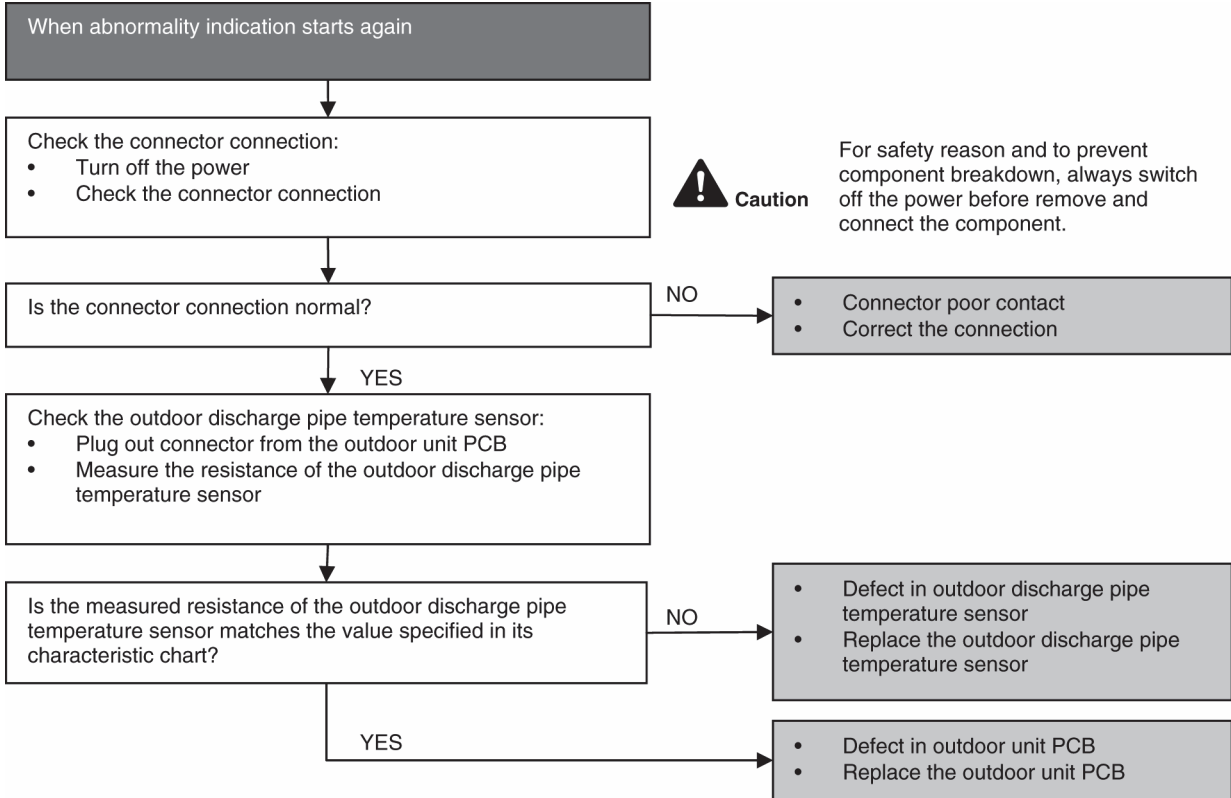

17.4.11 H32 (Outdoor Heat Exchanger Temperature Sensor 2 Abnormality)

Malfunction Decision Conditions

- During startup and operation of cooling and heating, the temperatures detected by the outdoor heat exchanger temperature sensor are used to determine sensor errors.

Malfunction Caused

- Faulty connector connection.
- Faulty sensor.
- Faulty PCB.

Troubleshooting

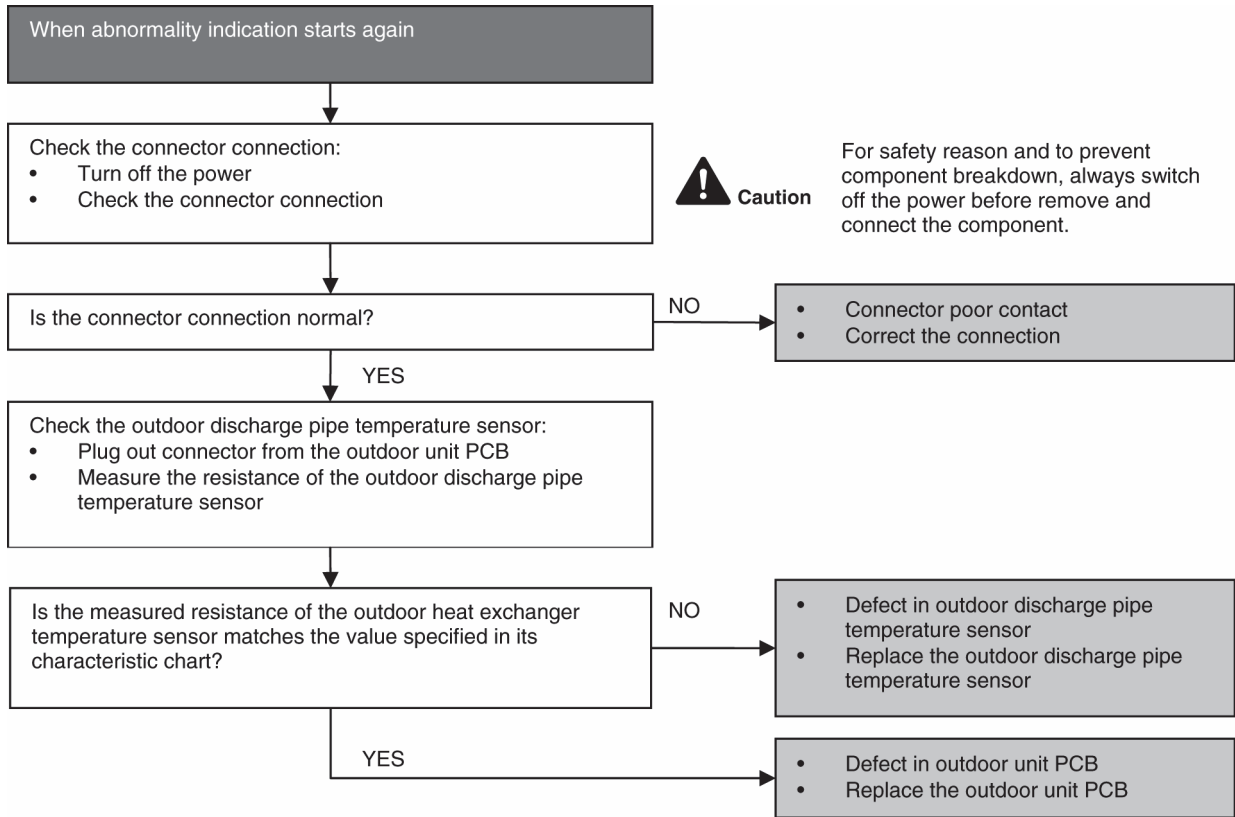

17.4.12 H33 (Unspecified Voltage between Indoor and Outdoor)

Malfunction Decision Conditions

- The supply power is detected for its requirement by the indoor/outdoor transmission.

Malfunction Caused

- Wrong models interconnected.
- Wrong indoor unit and outdoor unit PCBs used.
- Indoor unit or outdoor unit PCB defective.

Troubleshooting

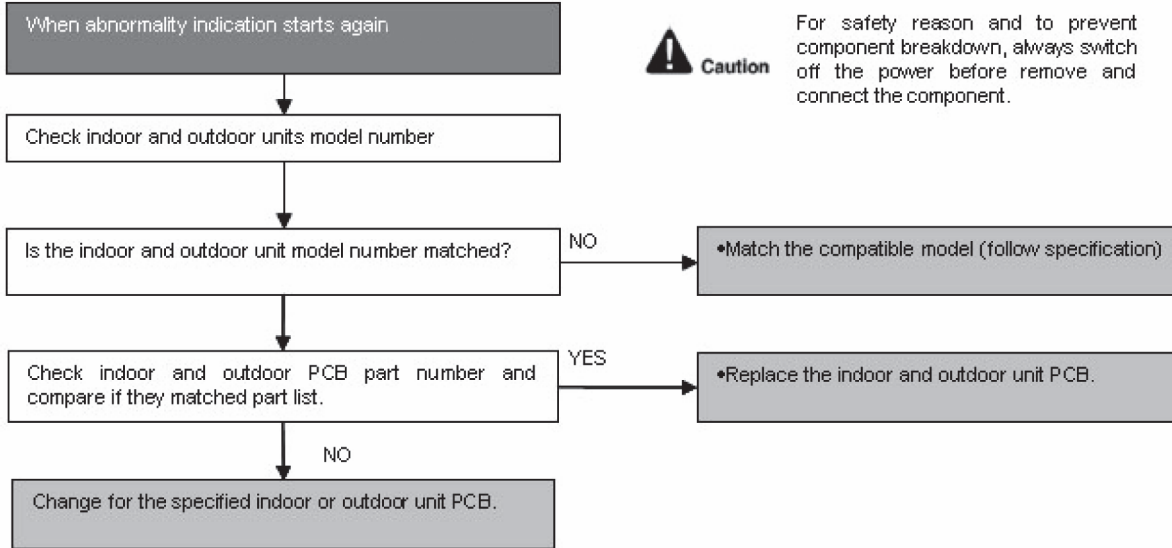

17.4.13 H34 (Outdoor Heat Sink Temperature Sensor Abnormality)

Malfunction Decision Conditions

- During startup and operation of cooling and heating, the temperatures detected by the outdoor heat sink temperature sensor are used to determine sensor errors.

Malfunction Caused

- Faulty connector connection.
- Faulty sensor.
- Faulty PCB.

Troubleshooting

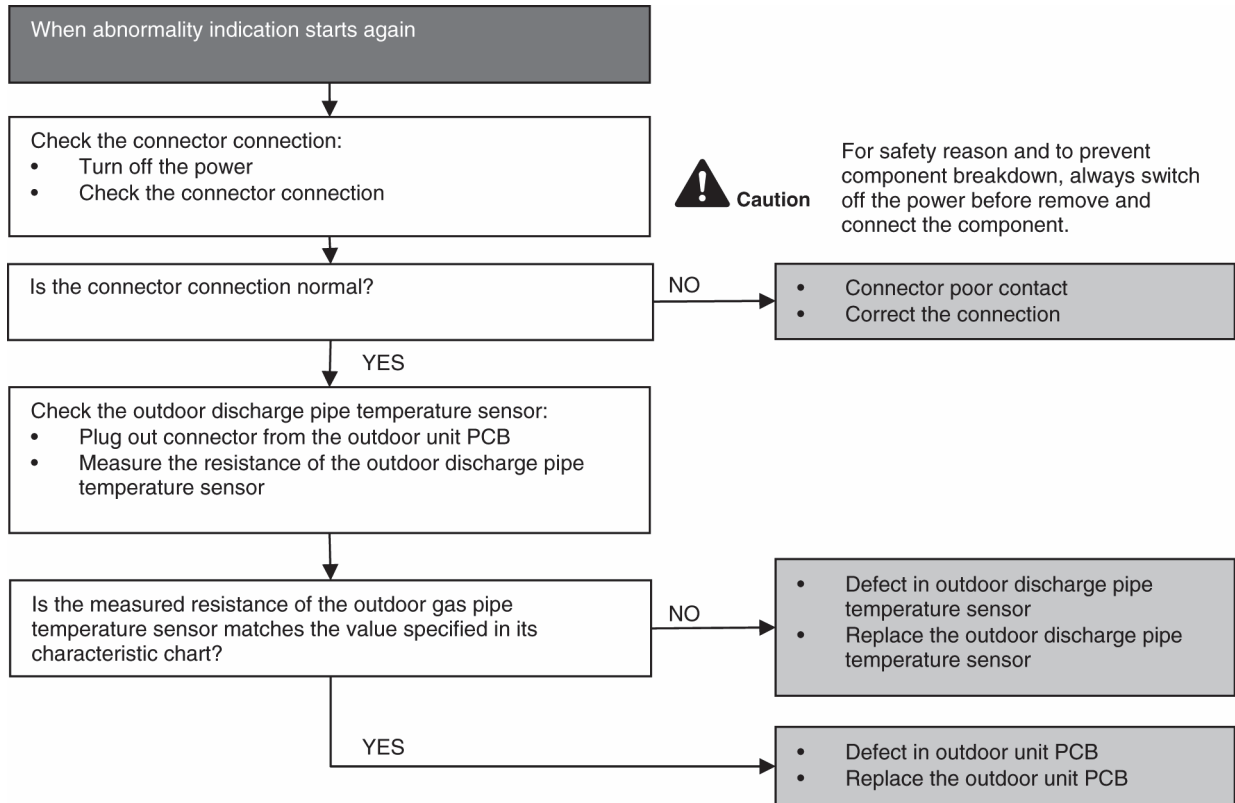

17.4.14 H36 (Outdoor Gas Pipe Sensor Abnormality)

Malfunction Decision Conditions

- During startup and operation of cooling and heating, the temperatures detected by the outdoor gas pipe temperature sensor are used to determine sensor errors.

Malfunction Caused

- Faulty connector connection.
- Faulty sensor.
- Faulty PCB.

Troubleshooting

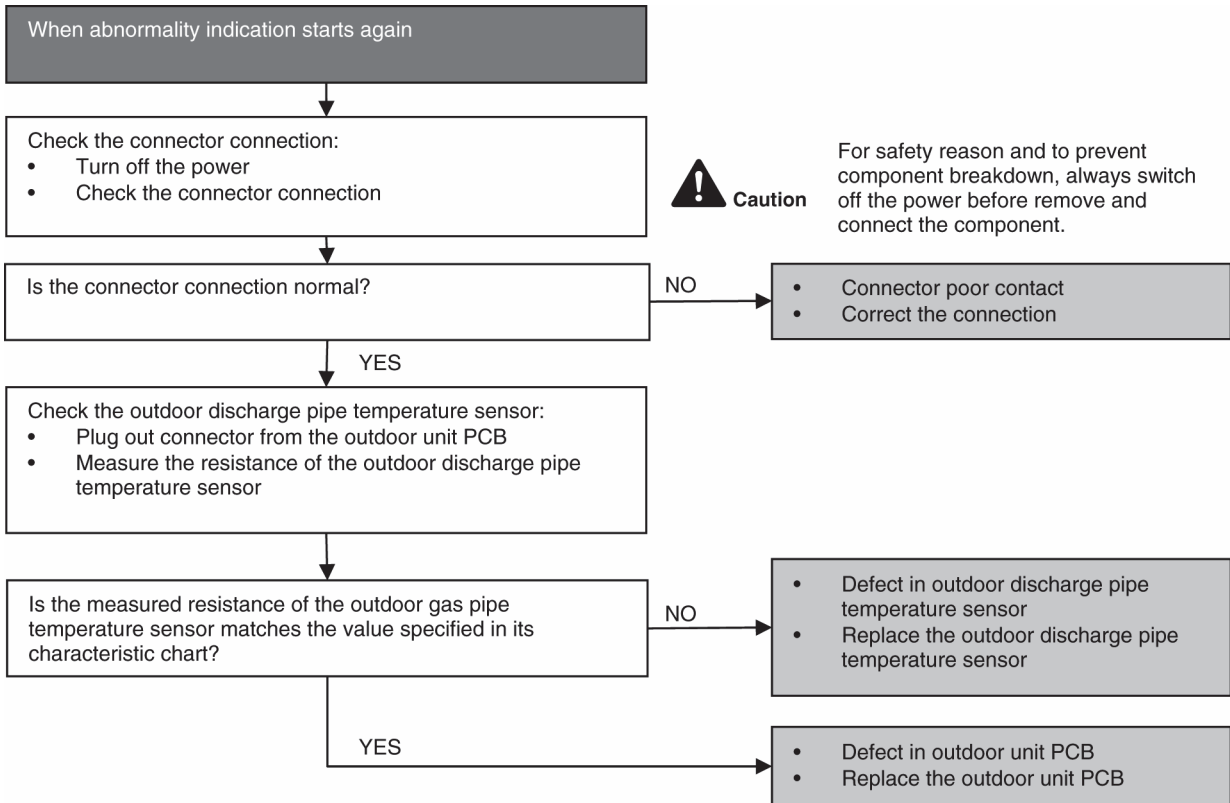

17.4.15 H37 (Outdoor Liquid Pipe Temperature Sensor Abnormality)

Malfunction Decision Conditions

- During startup and operation of cooling and heating, the temperatures detected by the outdoor liquid pipe temperature sensor are used to determine sensor errors.

Malfunction Caused

- Faulty connector connection.
- Faulty sensor.
- Faulty PCB.

Troubleshooting

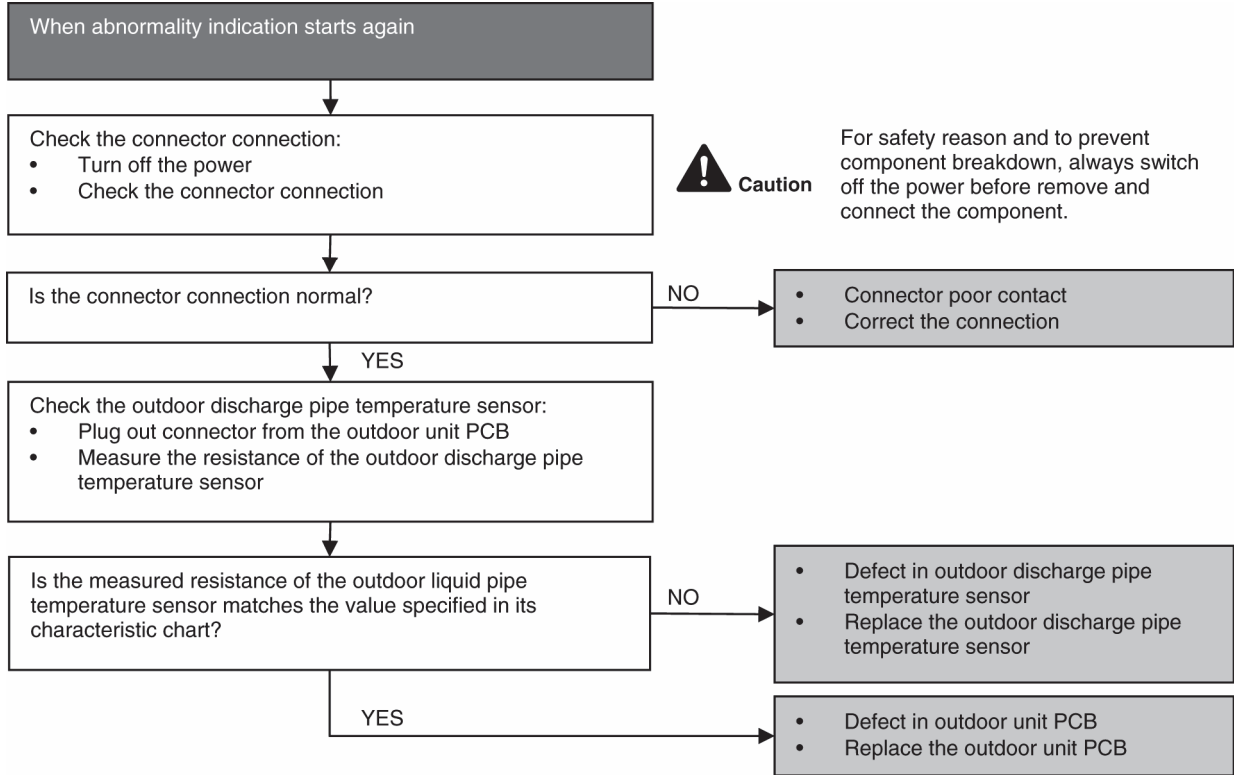

17.4.16 H97 (Outdoor Fan Motor – DC Motor Mechanism Locked)

Malfunction Decision Conditions

- The rotation speed detected by the Hall IC during fan motor operation is used to determine abnormal fan motor.

Malfunction Caused

- Operation stops due to short circuit inside the fan motor winding.
- Operation stops due to breaking of wire inside the fan motor.
- Operation stops due to breaking of fan motor lead wires.
- Operation stops due to Hall IC malfunction.
- Operation error due to faulty outdoor unit PCB.

Troubleshooting

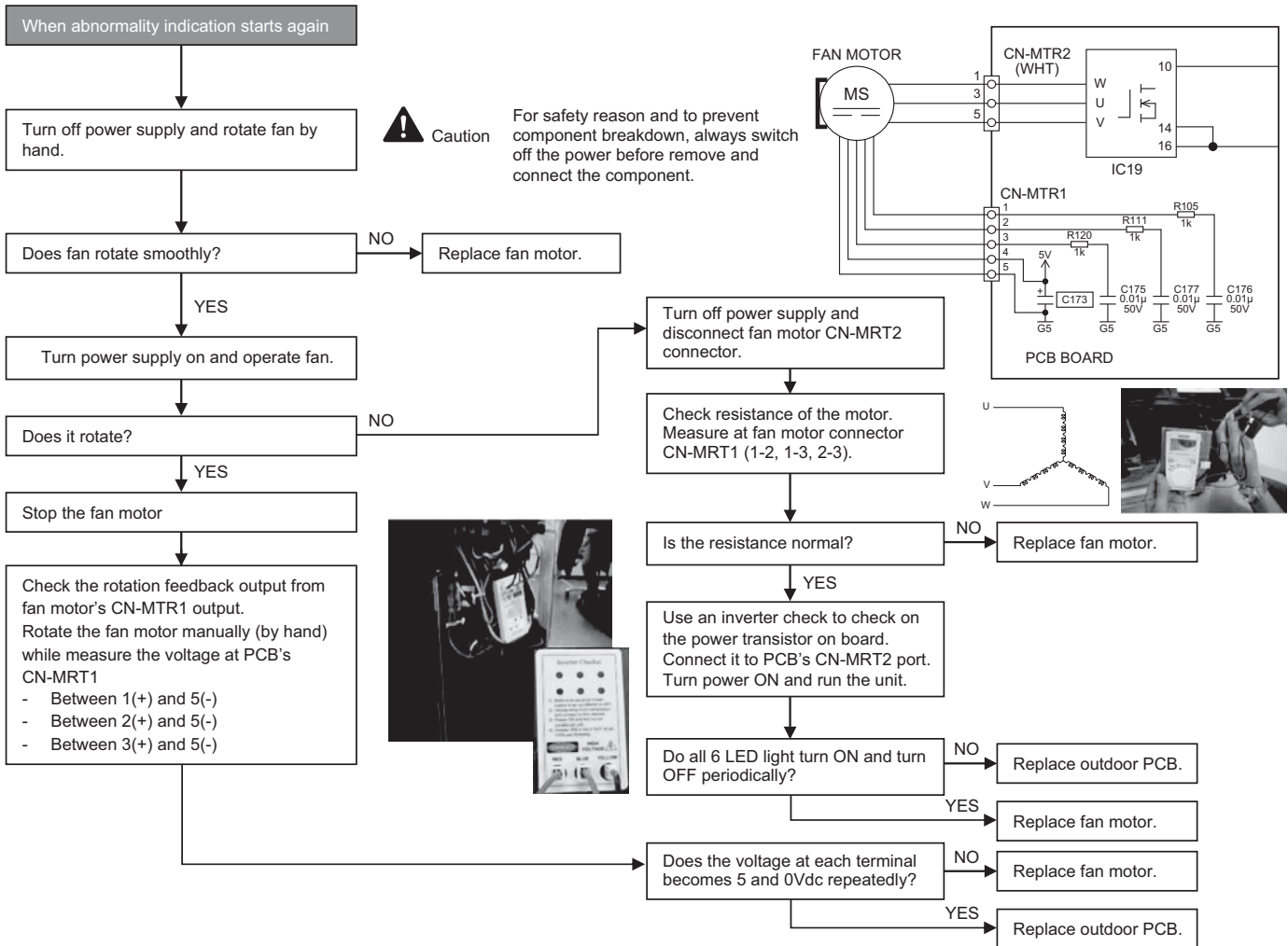

17.4.17 H98 (Error Code Stored in Memory and no alarm is triggered / no TIMER LED flashing)

Malfunction Decision Conditions

- Indoor high pressure is detected when indoor heat exchanger is detecting very high temperature when the unit is operating in heating operation.
- Phenomena: unit is stopping and re-starting very often in heating mode

Malfunction Caused

- Indoor heat exchanger thermistor
- Clogged air filter or heat exchanger
- Over-bent pipe (liquid side)

Troubleshooting

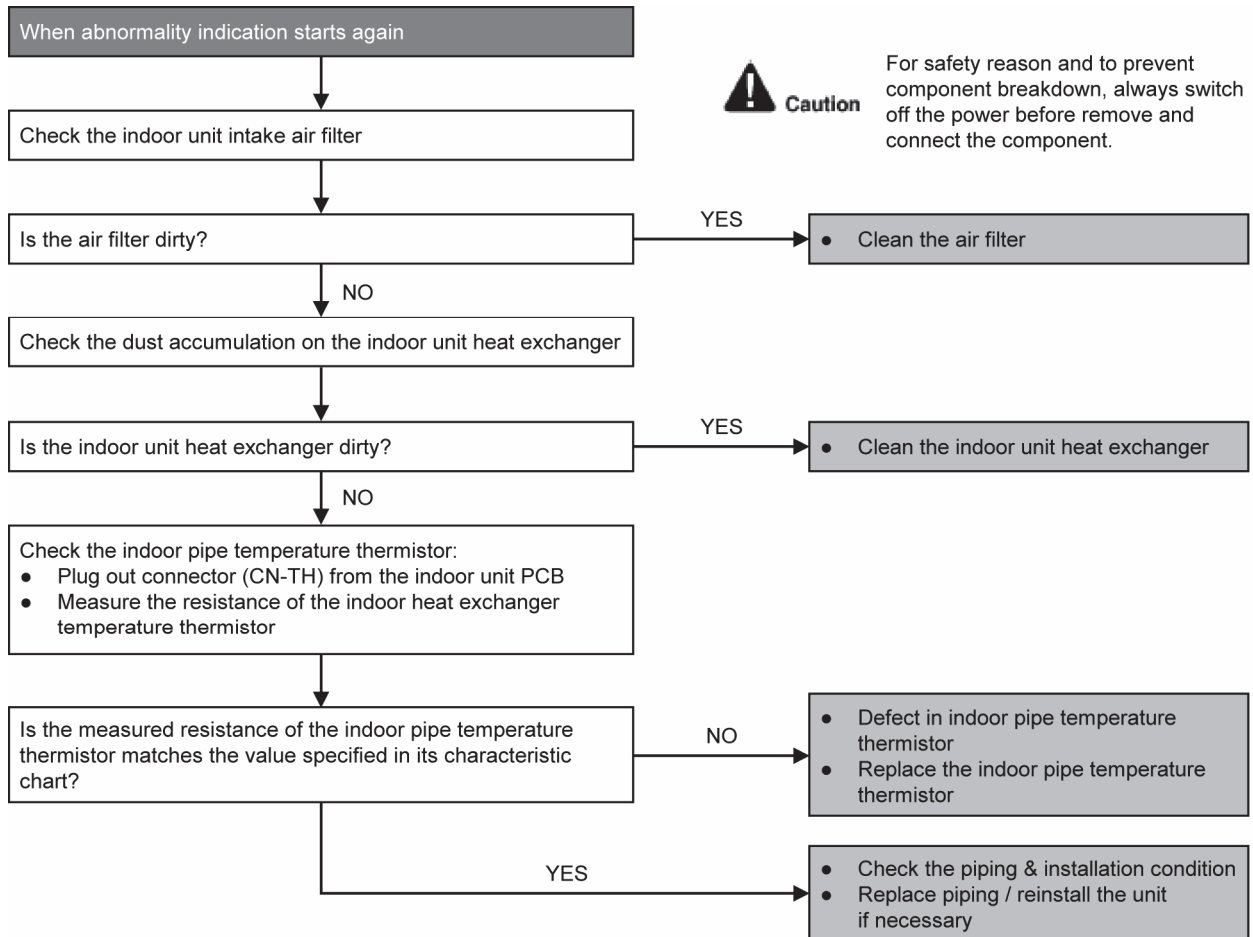

17.4.18 H99 (Indoor Freeze Prevention Protection: Cooling or Soft Dry)

Error Code will not display (no Timer LED blinking) but store in EEPROM

Malfunction Decision Conditions

- Freeze prevention control takes place (when indoor pipe temperature is lower than 2°C)

Malfunction Caused

- Air short circuit at indoor unit
- Clogged indoor unit air filter
- Dust accumulation on the indoor unit heat exchanger
- 2/3 way valve closed
- Faulty indoor unit fan motor
- Refrigerant shortage (refrigerant leakage)
- Clogged expansion valve or strainer
- Faulty indoor pipe temperature sensor
- Faulty indoor unit PCB

Troubleshooting

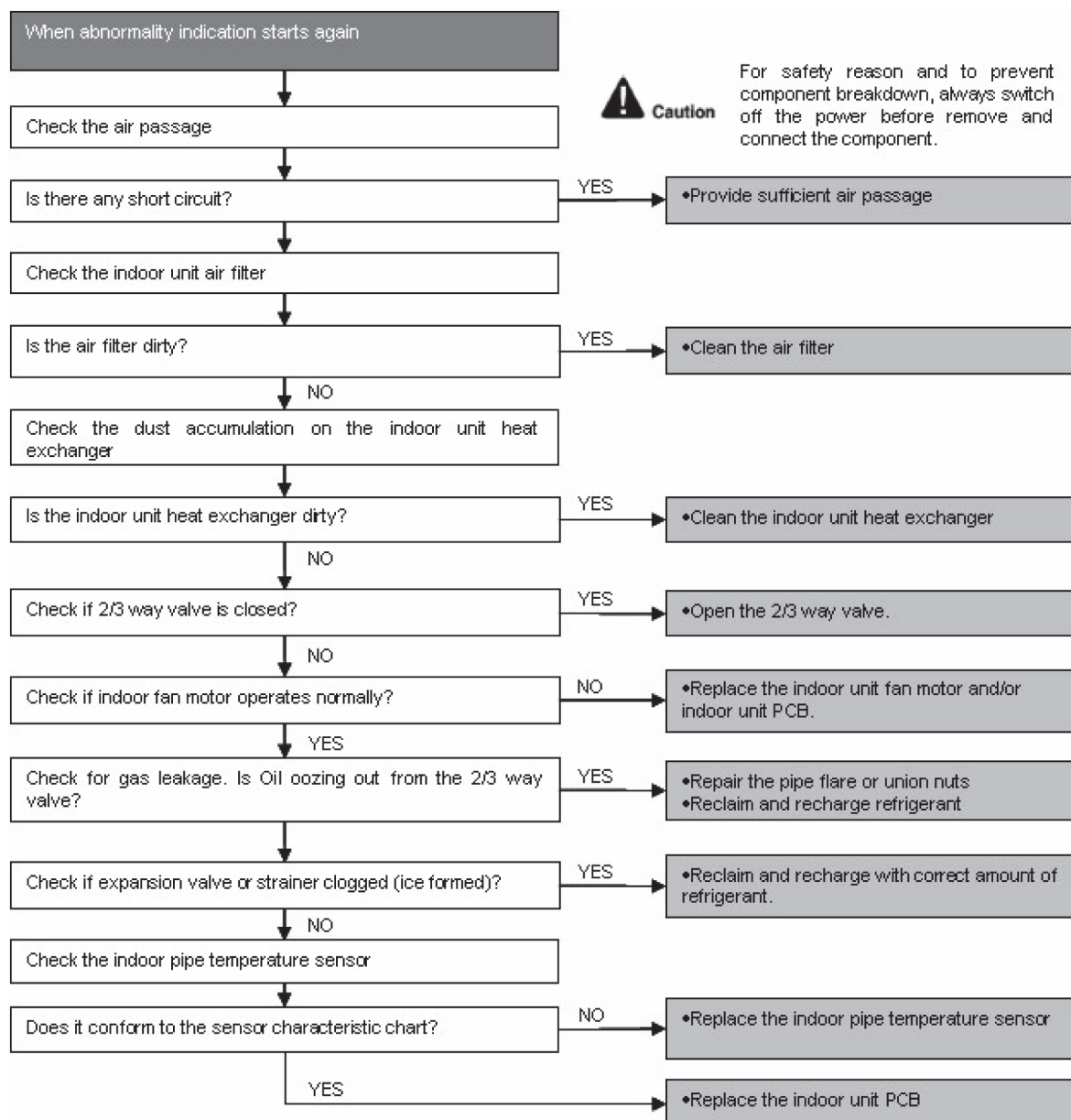

17.4.19 F11 (4-way Valve Switching Failure)

Malfunction Decision Conditions

- When indoor heat exchanger is cold during heating (except deice) or when indoor heat exchanger is hot during cooling and compressor operating, the 4-way valve is detected as malfunction.

Malfunction Caused

- Indoor heat exchanger (pipe) thermistor
- 4-way valve malfunction

Troubleshooting

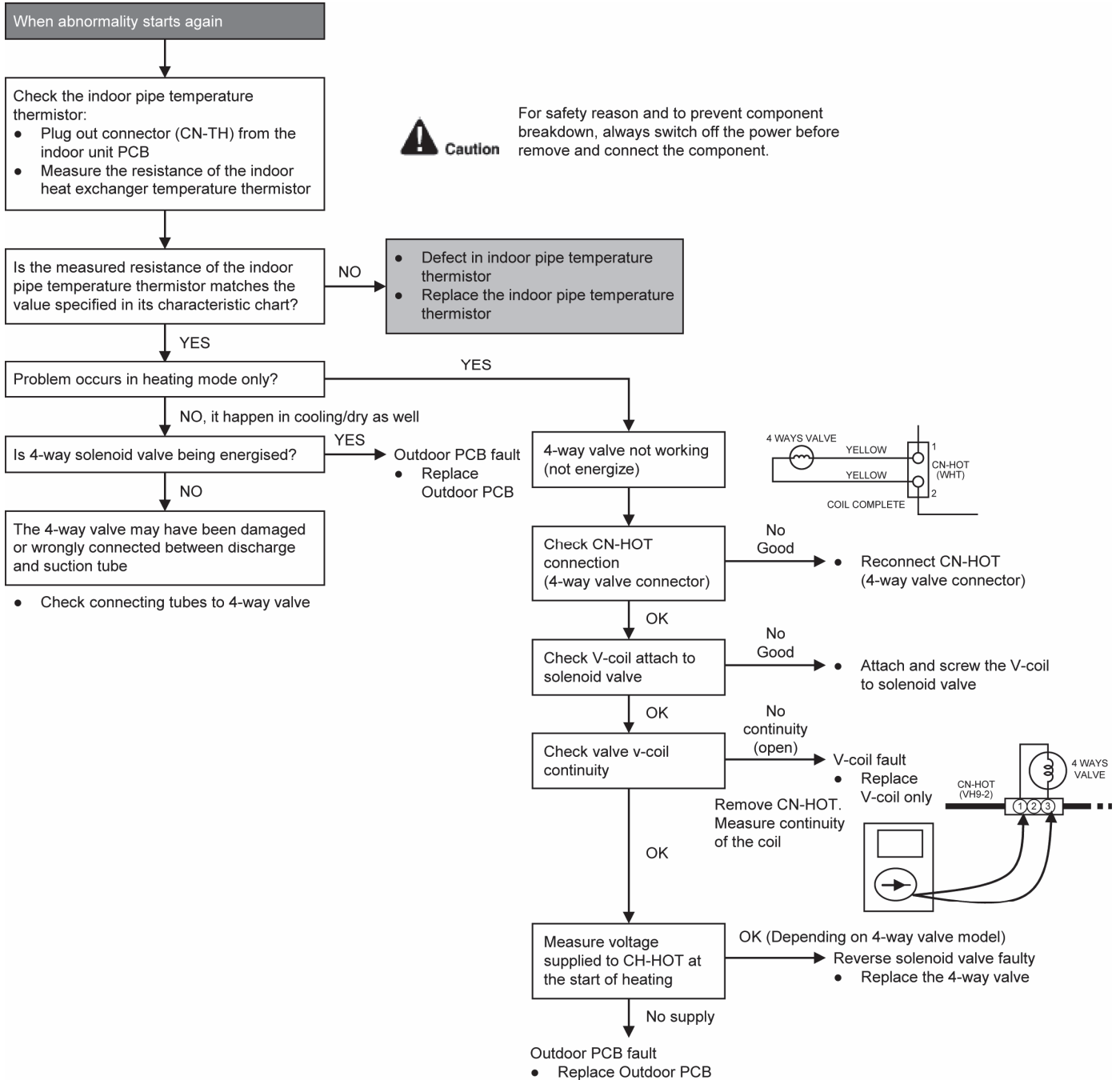

* Check gas side pipe – for hot gas flow in cooling mode

17.4.20 F17 (Indoor Standby Units Freezing Abnormality)

Malfunction Decision Conditions

- When the different between indoor intake air temperature and indoor pipe temperature is above 10°C or indoor pipe temperature is below -1.0°C.

Remark:

When the indoor standby unit is freezing, the outdoor unit transfers F17 error code to the corresponding indoor unit and H39 to other indoor unit(s).

Malfunction Caused

- Wrong wiring connection
- Faulty sensor
- Faulty expansion valve

Troubleshooting

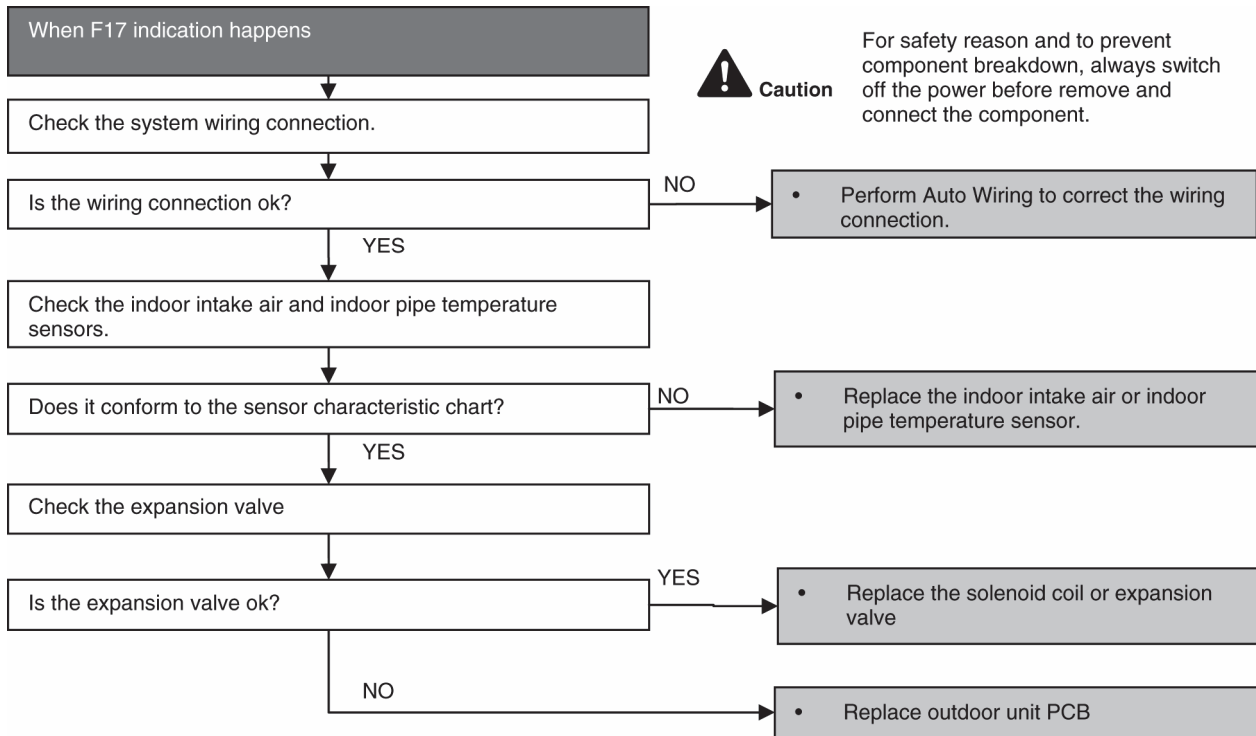

17.4.21 F90 (Power Factor Correction Protection)

Malfunction Decision Conditions

- To maintain DC voltage level supply to power transistor.
- To detect high DC voltage level after rectification.

Malfunction Caused

- During startup and operation of cooling and heating, when Power Factor Correction (PFC) protection circuitry at the outdoor unit main PCB senses abnormal DC voltage level for power transistors.
- When DC voltage detected is LOW, transistor switching will turn ON by controller to push-up the DC level.
- When DC voltage detected is HIGH (391Vdc – 425Vdc), active LOW signal will send by the controller to turn OFF relay RY-C.

Troubleshooting

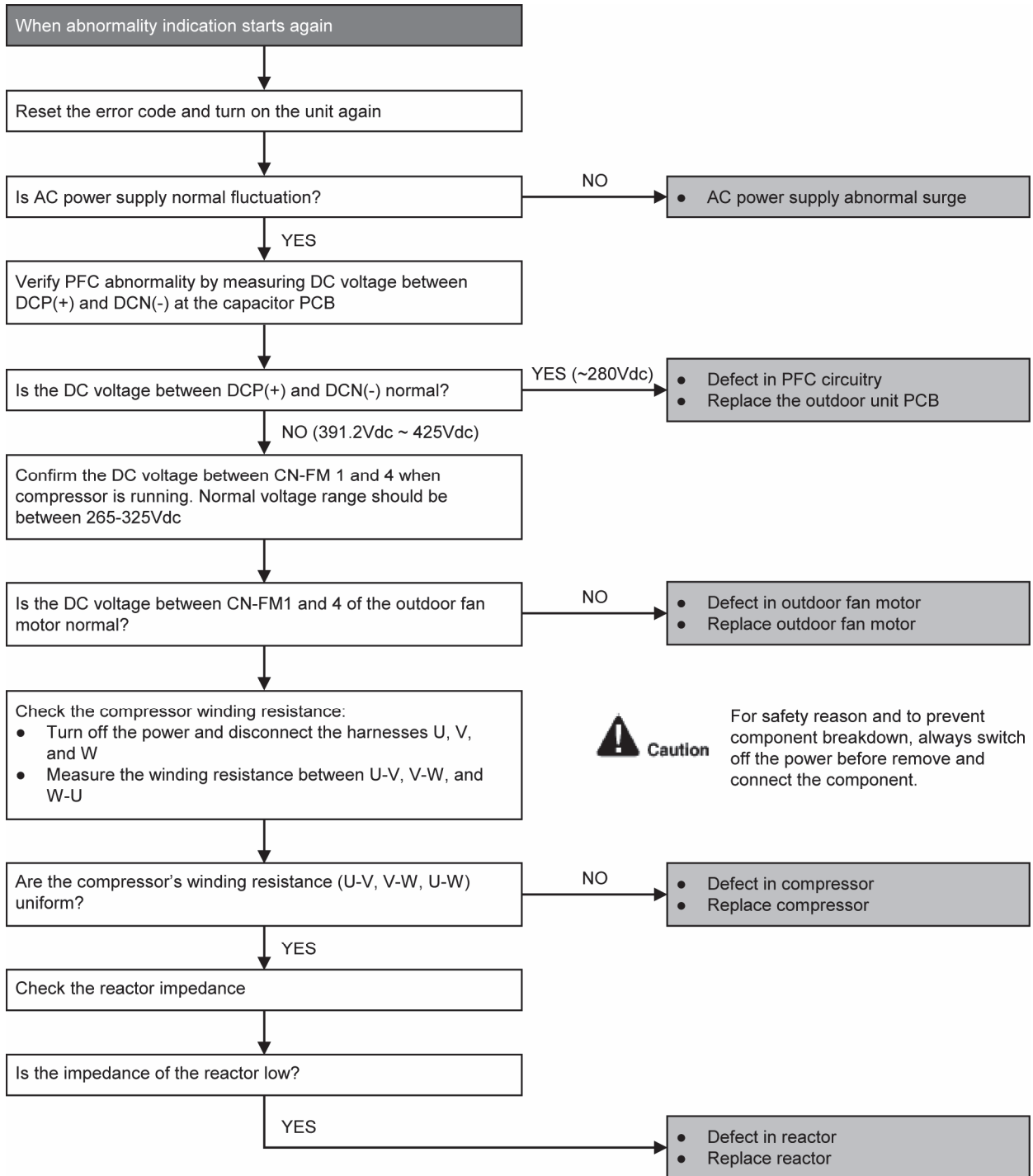

17.4.22 F91 (Refrigeration Cycle Abnormality)

Malfunction Decision Conditions

- The input current is low while the compressor is running at higher than the setting frequency.

Malfunction Caused

- Lack of gas.
- 3-way valve close.

Troubleshooting

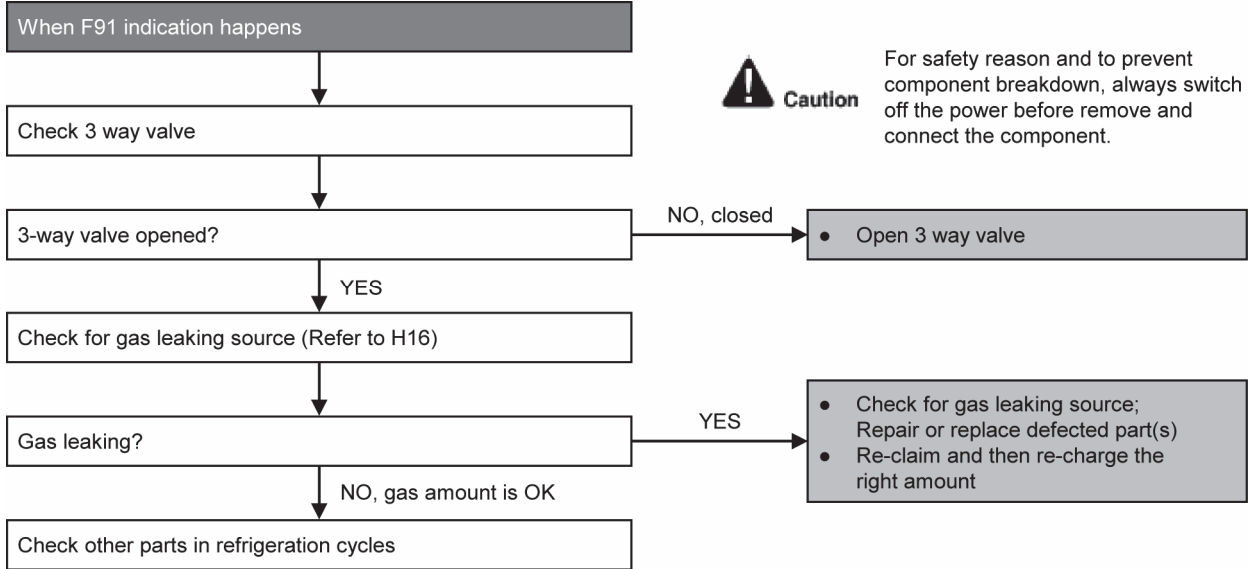

17.4.23 F93 (Compressor Rotation Failure)

Malfunction Decision Conditions

- A compressor rotation failure is detected by checking the compressor running condition through the position detection circuit.

Malfunction Caused

- Compressor terminal disconnect
- Faulty Outdoor PCB
- Faulty compressor

Troubleshooting

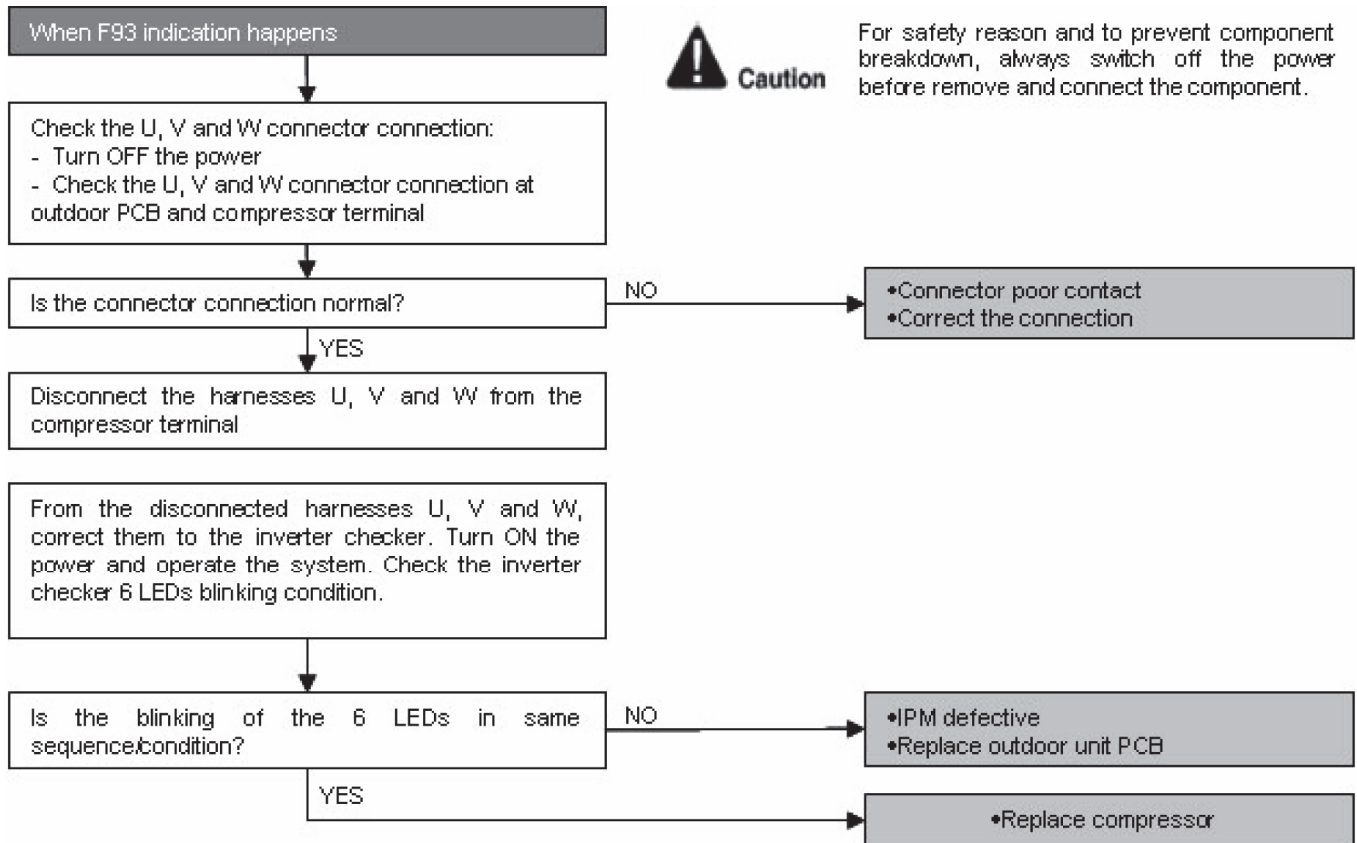

17.4.24 F95 (Outdoor High Pressure Protection: Cooling or Soft Dry)

Malfunction Decision Conditions

- During operation of cooling or soft dry, when outdoor unit heat exchanger high temperature data is detected by the outdoor unit heat exchanger thermistor.

Malfunction Caused

- Outdoor heat exchanger temperature rise due to short-circuit of hot discharge air flow.
- Outdoor heat exchanger temperature rise due to defective of outdoor fan motor.
- Outdoor heat exchange temperature rise due to defective outdoor heat exchanger thermistor.
- Outdoor heat exchanger temperature rise due to defective of outdoor unit PCB.

Troubleshooting

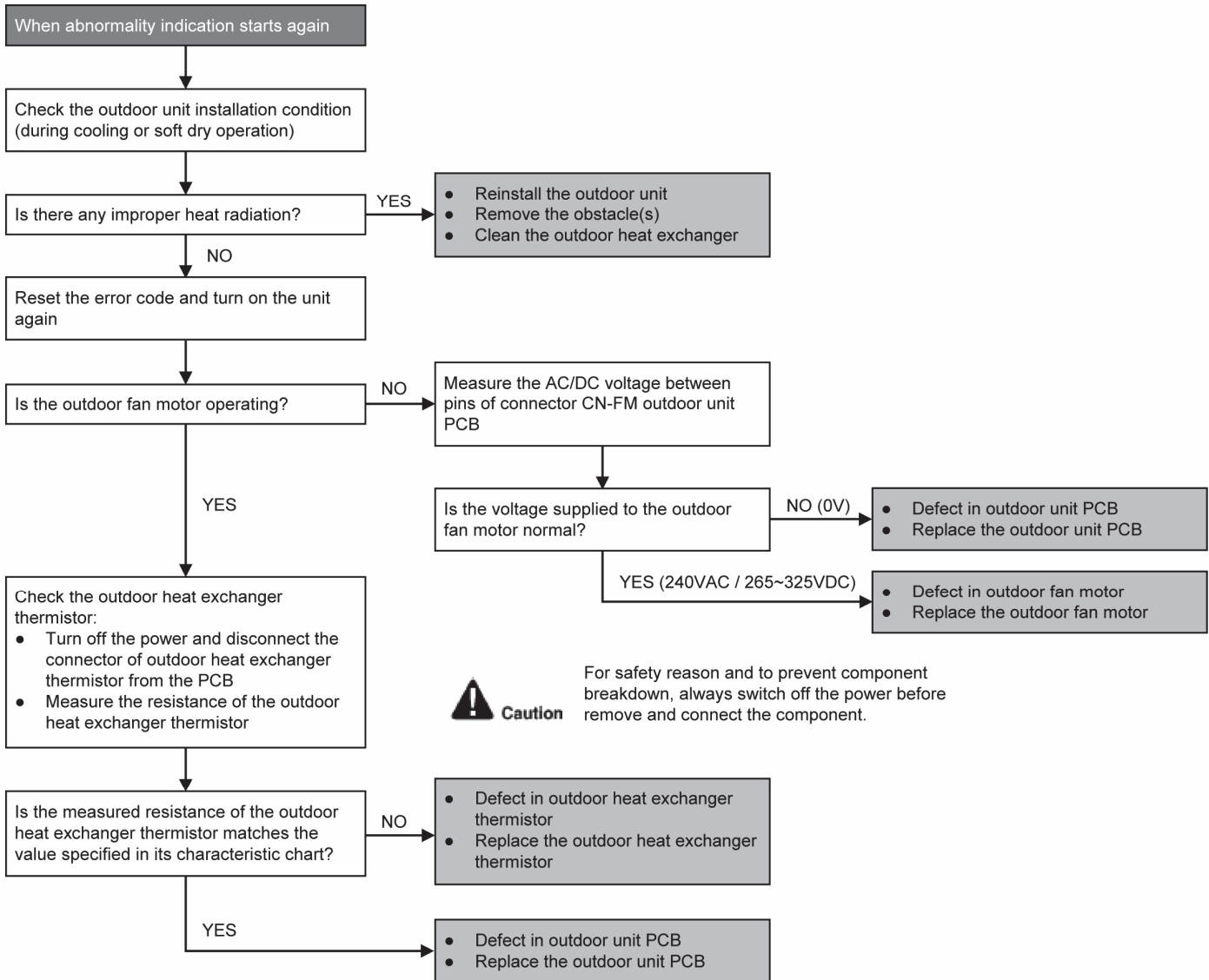

17.4.25 F96 (IPM Overheating)

Malfunction Decision Conditions

- During operating of cooling and heating, when IPM temperature data (100°C) is detected by the IPM temperature sensor.

Multi Models only

- Compressor Overheating: During operation of cooling and heating, when the compressor OL is activated.
- Heat Sink Overheating: During operation of cooling and heating, when heat sink temperature data (90°C) is detected by the heat sink temperature sensor.

Malfunction Caused

- IPM overheats due to short circuit of hot discharge air flow.
- IPM overheats due to defective of outdoor fan motor.
- IPM overheats due to defective of internal circuitry of IPM.
- IPM overheats due to defective IPM temperature sensor.

Multi Models Only

- Compressor OL connector poor contact.
- Compressor OL faulty.

Troubleshooting

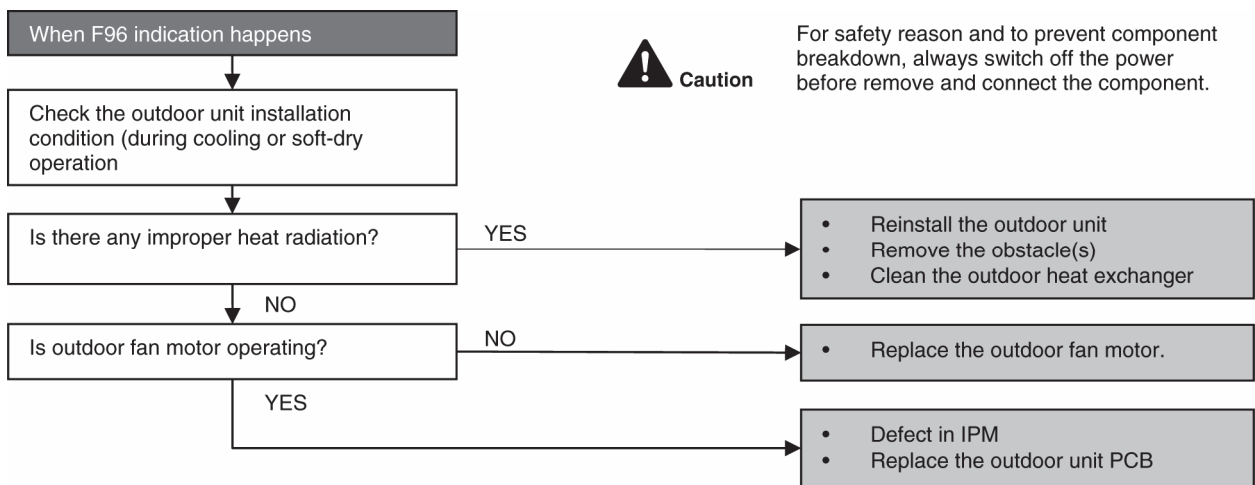

17.4.26 F97 (Compressor Overheating)

Malfunction Decision Conditions

- During operation of cooling and heating, when compressor tank temperature data (112°C) is detected by the compressor tank temperature sensor.

Malfunction Caused

- Faulty compressor tank temperature sensor
- 2/3 way valve closed
- Refrigerant shortage (refrigerant leakage)
- Faulty outdoor unit PCB
- Faulty compressor

Troubleshooting

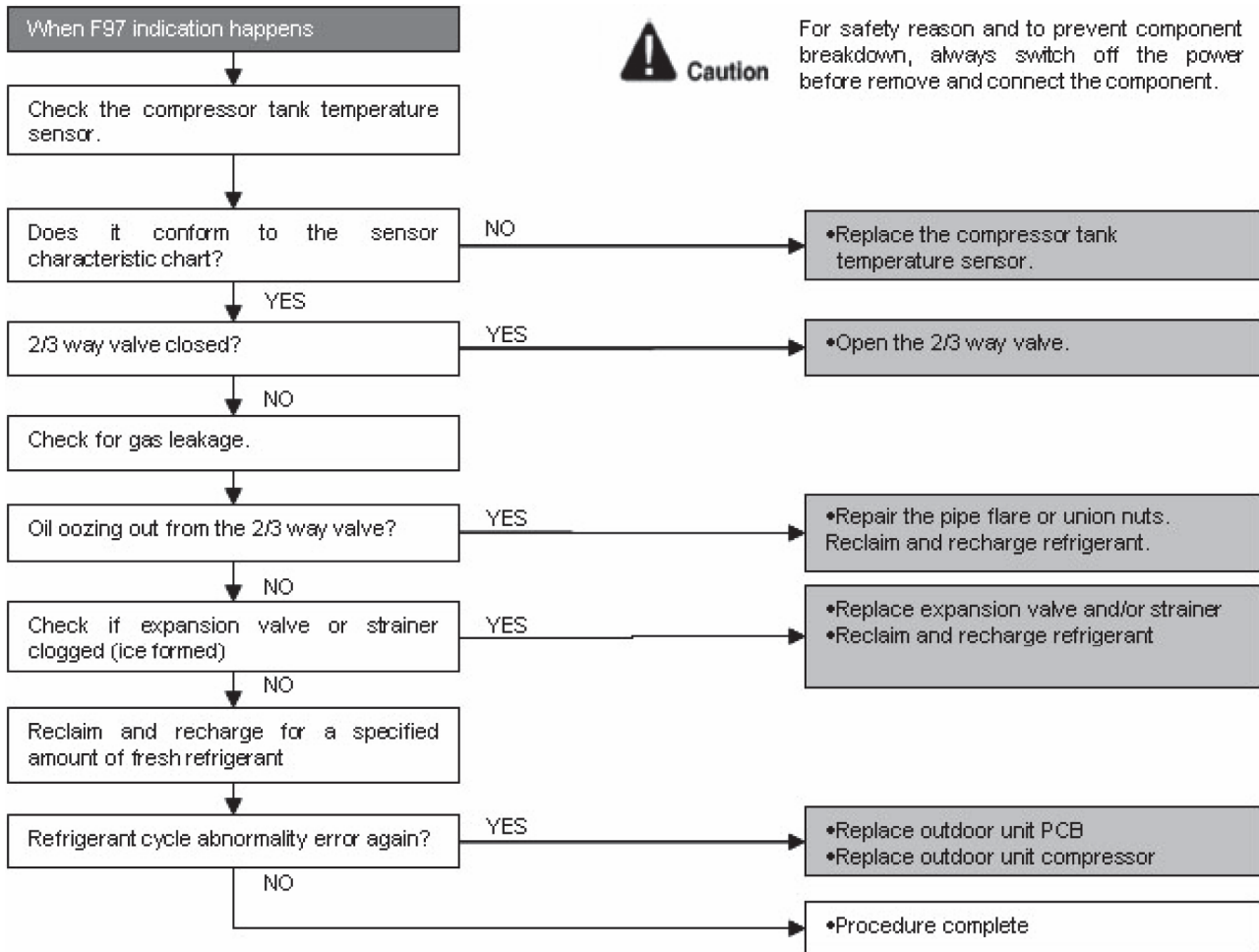

17.4.27 F98 (Input Over Current Detection)

Malfunction Decision Conditions

- During operation of cooling and heating, when an input over-current (X value in Total Running Current Control) is detected by checking the input current value being detected by current transformer (CT) with the compressor running.

Malfunction Caused

- Excessive refrigerant.
- Faulty outdoor unit PCB.

Troubleshooting

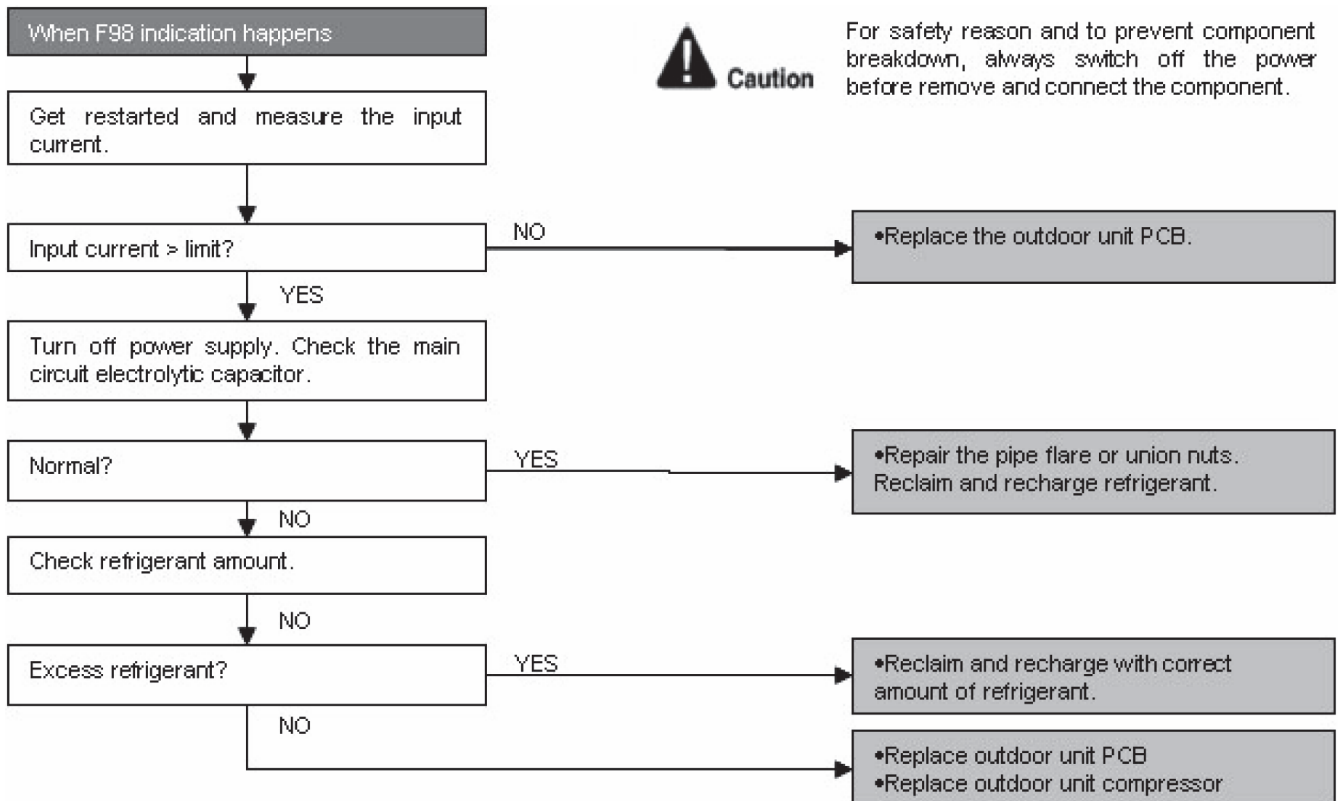

17.4.28 F99 (DC Peak Detection)

Malfunction Decision Conditions

During startup and operation of cooling and heating, when inverter DC peak data is received by the outdoor internal DC Peak sensing circuitry.

Malfunction Caused

- DC current peak due to compressor failure.
- DC current peak due to defective power transistor(s).
- DC current peak due to defective outdoor unit PCB.
- DC current peak due to short circuit.

Troubleshooting

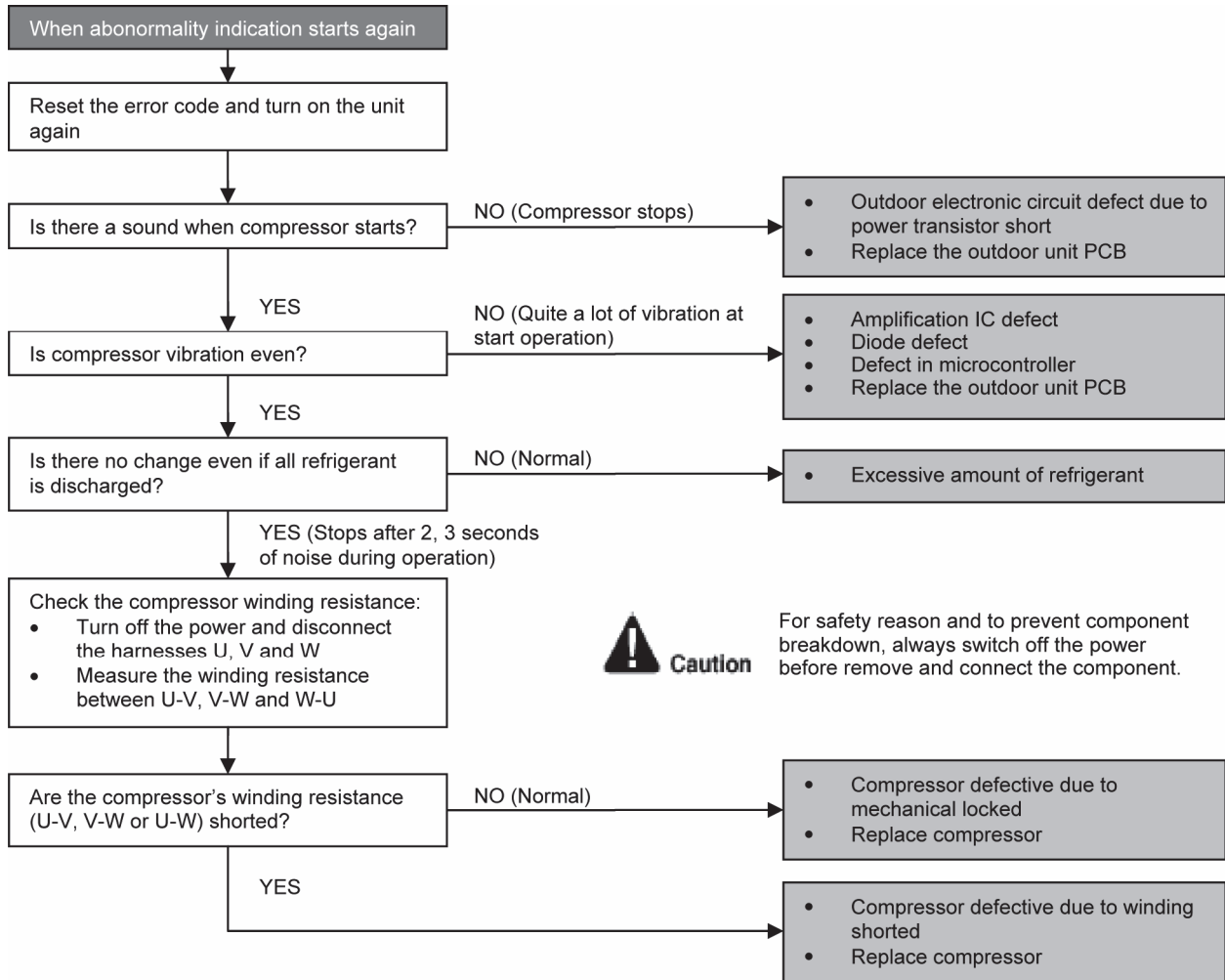

18. Disassembly and Assembly Instructions

WARNING

High Voltage is generated in the electrical parts area by the capacitor. Ensure that the capacitor has discharged sufficiently before proceeding with repair work. Failure to heed this caution may result in electric shocks.

18.1 Indoor Electronic Controllers, Cross Flow Fan and Indoor Fan Motor Removal Procedures

18.1.1 Air Filters Removal Procedures



Figure 1

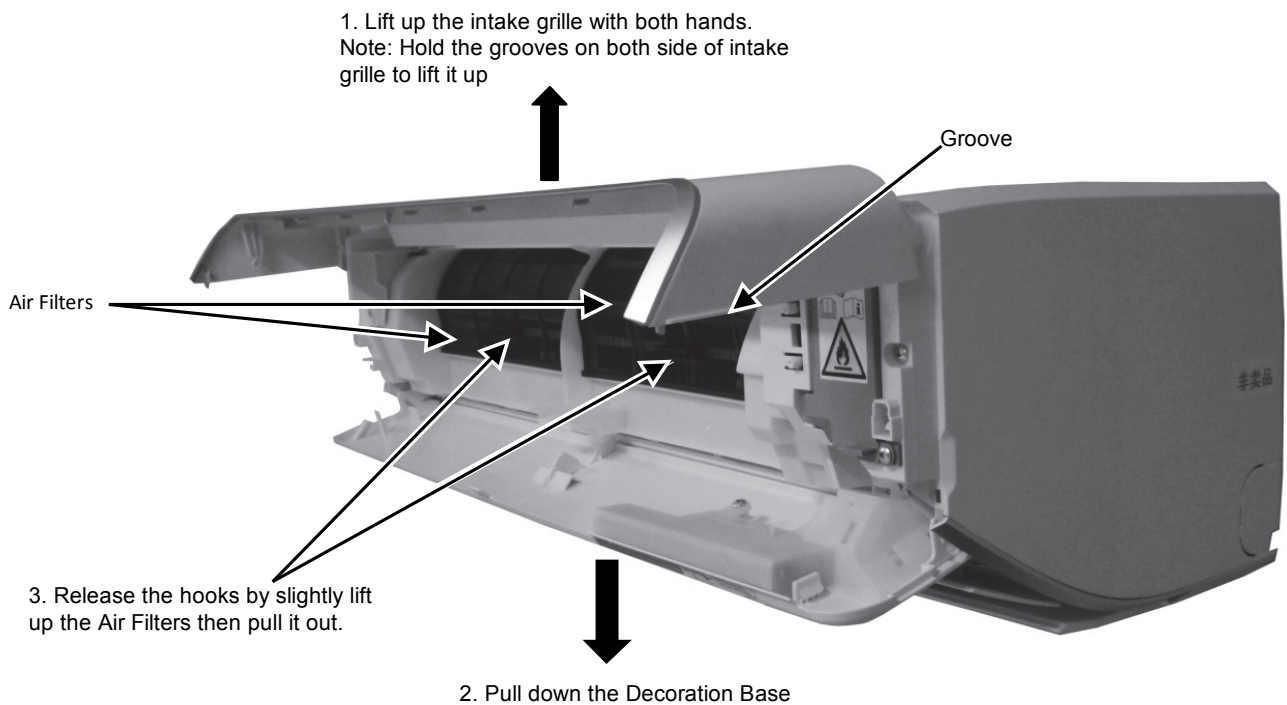

Figure 2

18.1.2 Front Grille Complete Removal Procedures

1. Push the intake grille further up then pull it towards you to remove it.

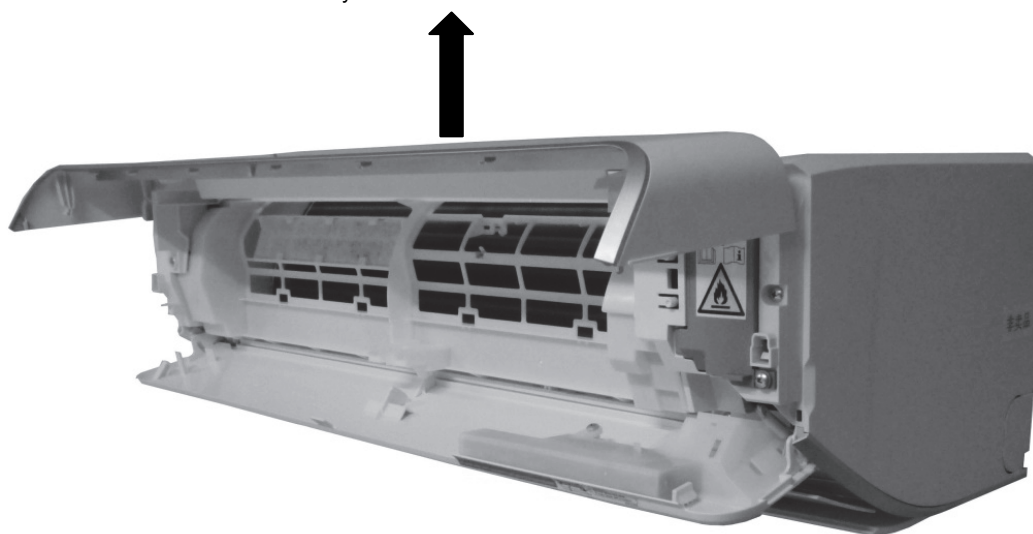
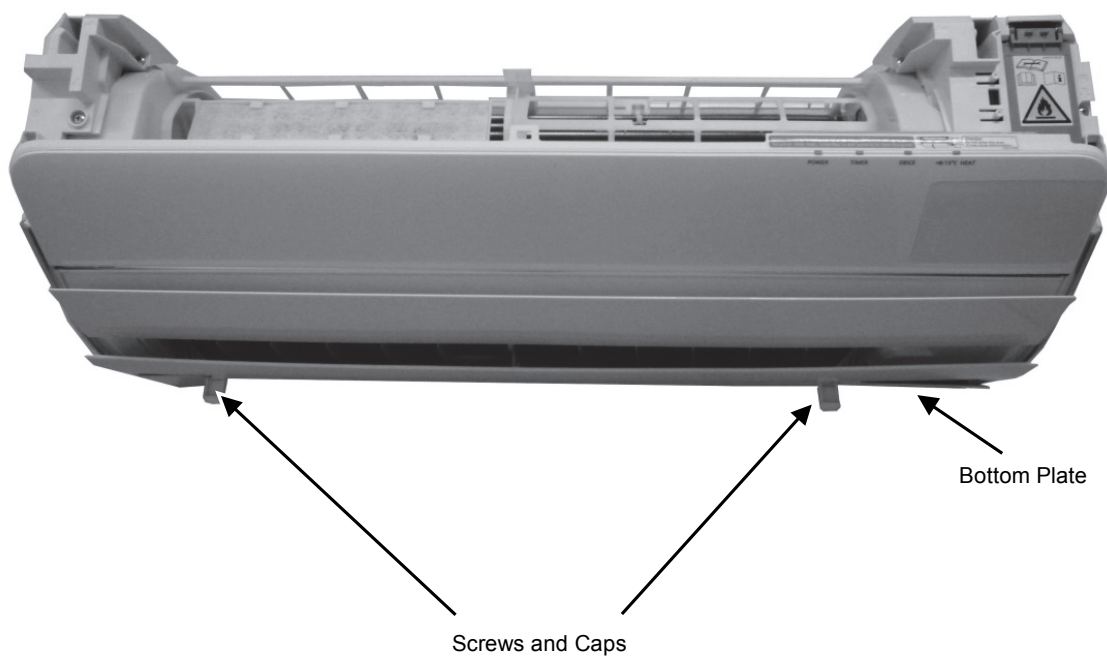

Figure 3



2. Remove the caps and screw from the Bottom Plate. Then pull out the Bottom Plate.

Figure 4

To Reinstall the Bottom Plate

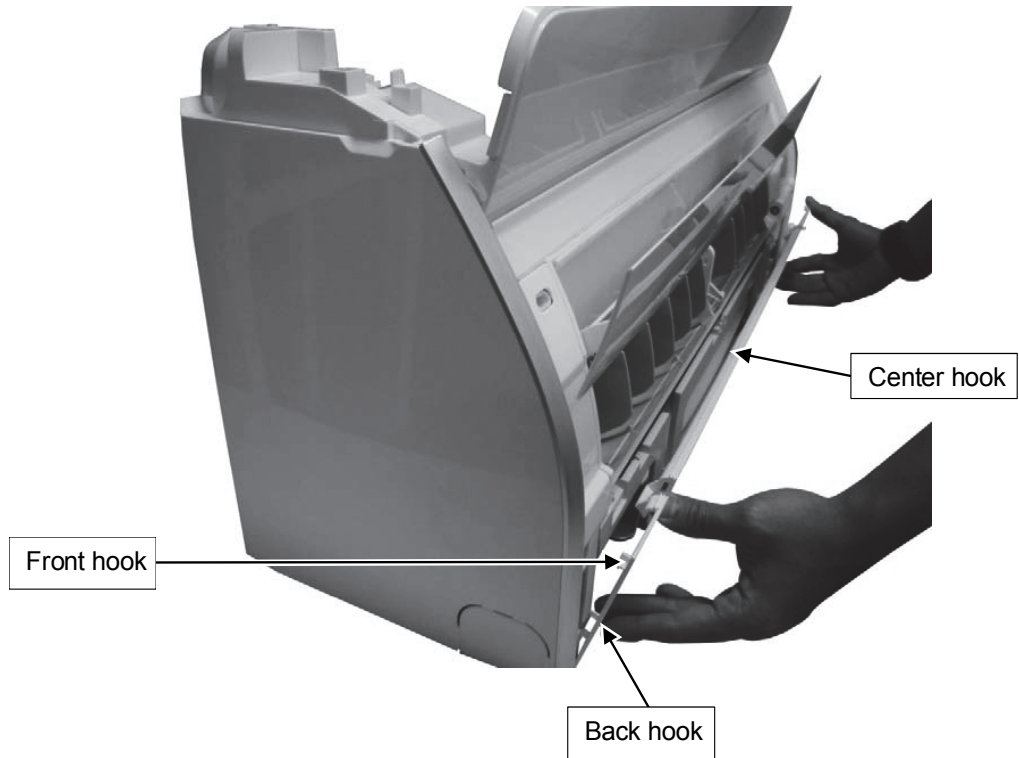

Note!

Align the bottom plate, then attached the back hooks (left and right) and center hook to its position. Then press firmly until the front hooks attached properly.

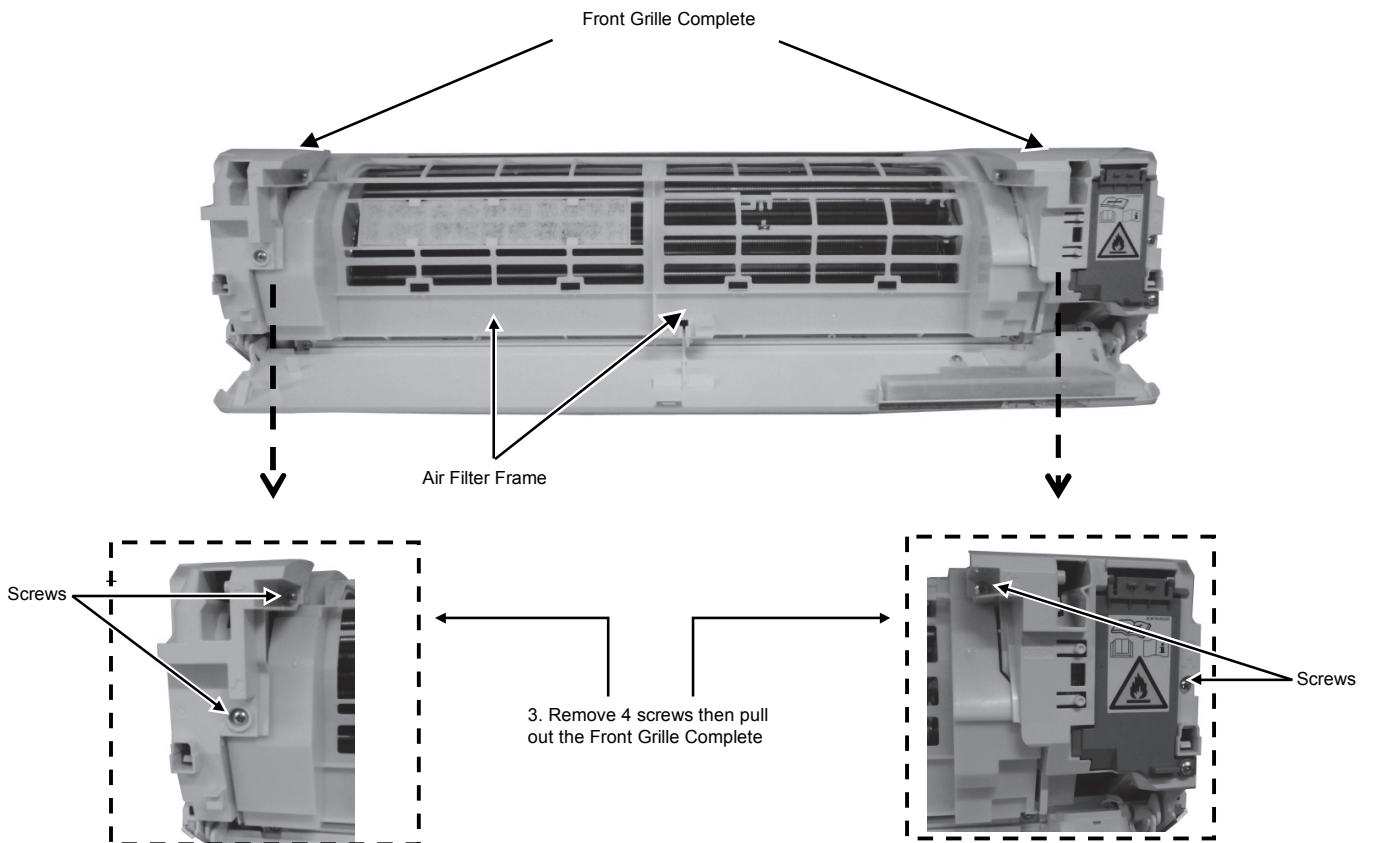

Figure 5

18.1.3 Indoor Main Electronic Controller Removal Procedures

1. Remove 2 screws from the right side of Front Grille Complete.

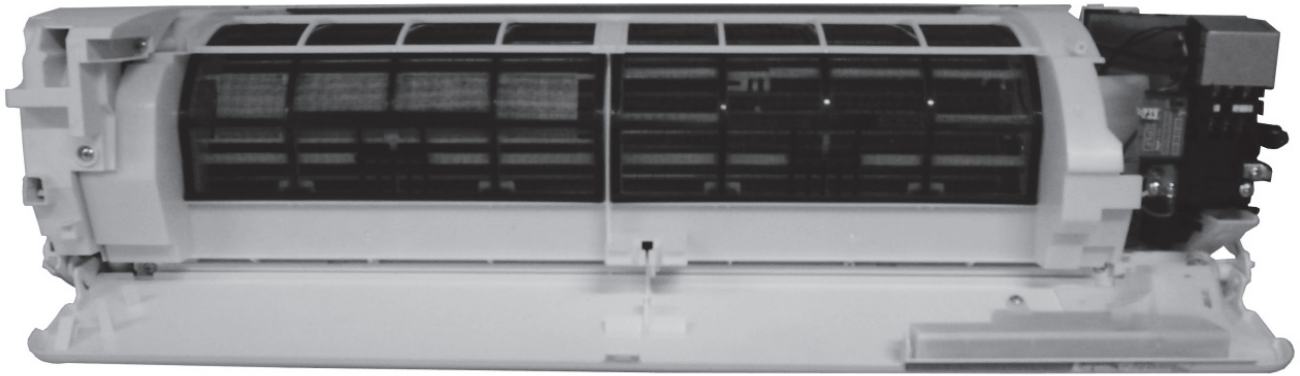
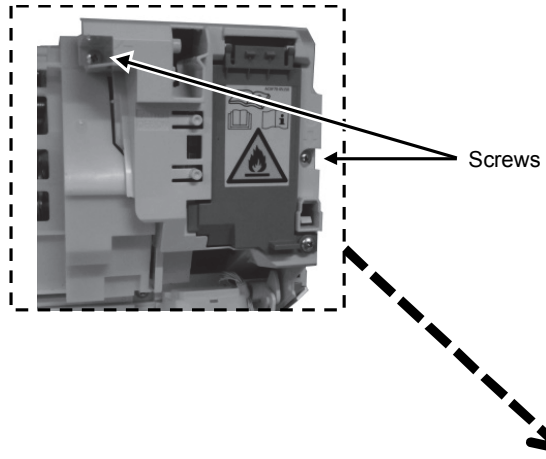

Figure 6

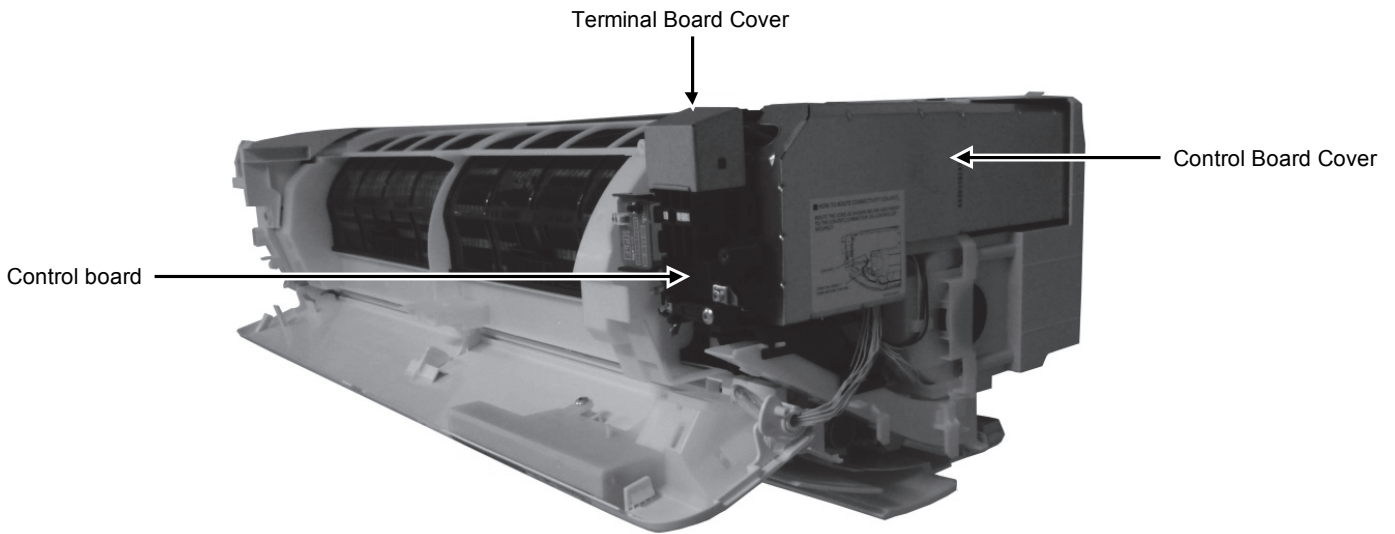
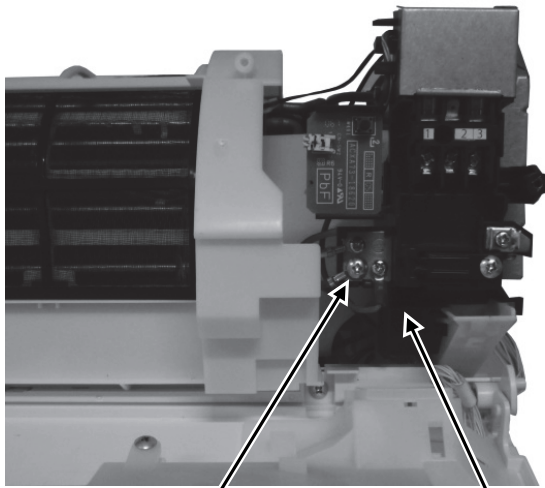

Figure 7



3. Detach the earth wire from the control board.

2. Remove 1 screw from the control board.

Figure 8

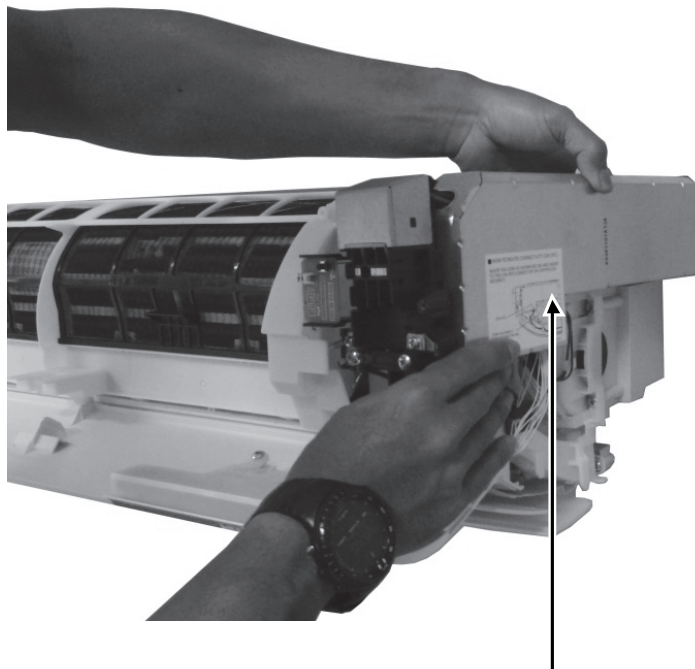

4. Slightly pull out the control board.

Figure 9

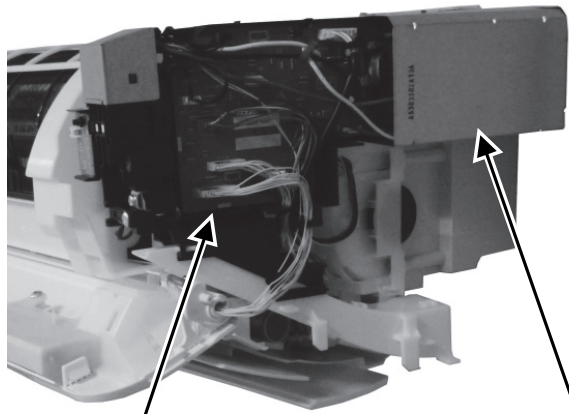

5. Remove the upper control board cover by releasing 4 hooks.

6. Remove the bottom control board cover by releasing 5 hooks.

Figure 10

7. Remove the terminal board cover.

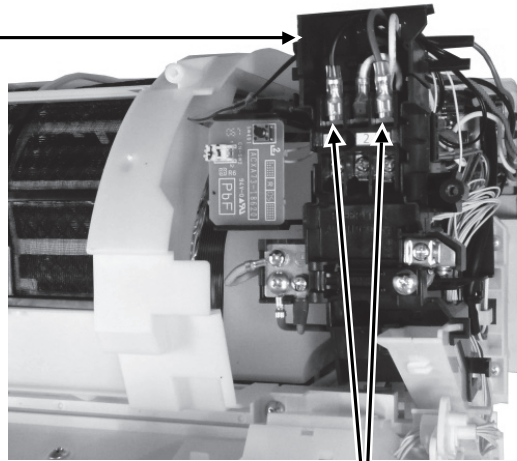

8. Detach lead wires AC1 (Black) and AC3 (Red) from the terminal board.

Figure 11

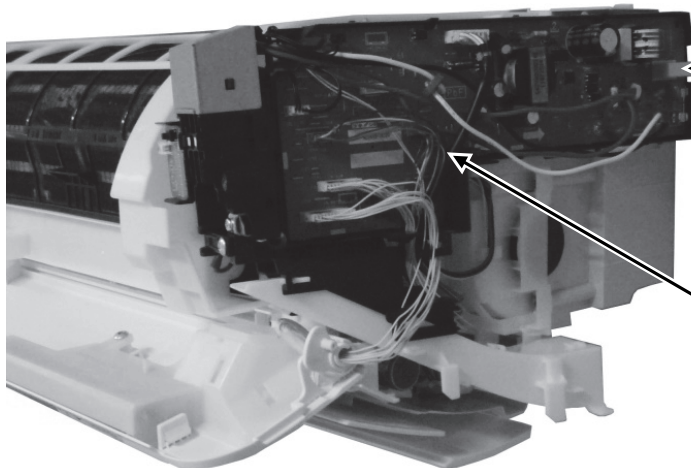

Indoor Main Electronic Controller

9. Remove all connectors from the PCB. Then pull out the Indoor Main Electronic Controller.

Figure 12

18.1.4 Sub Electronic Controller Removal Procedures

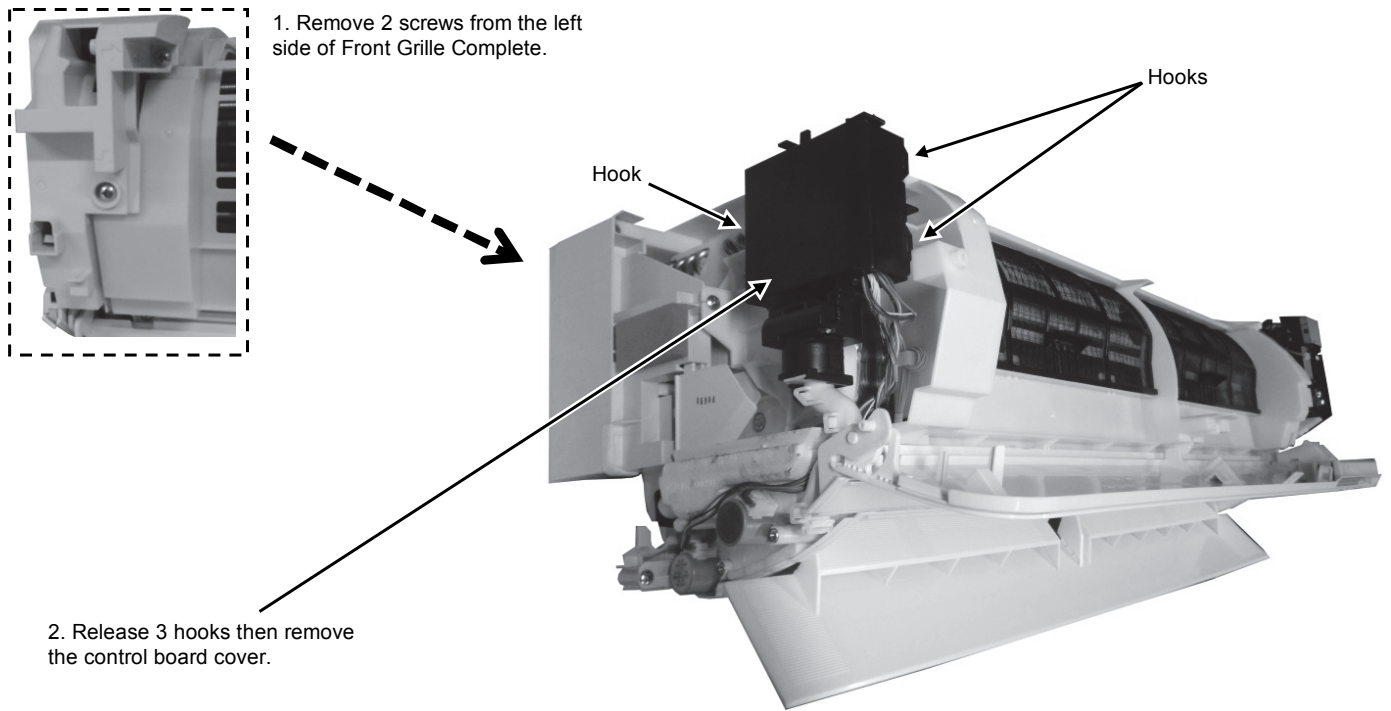

Figure 13

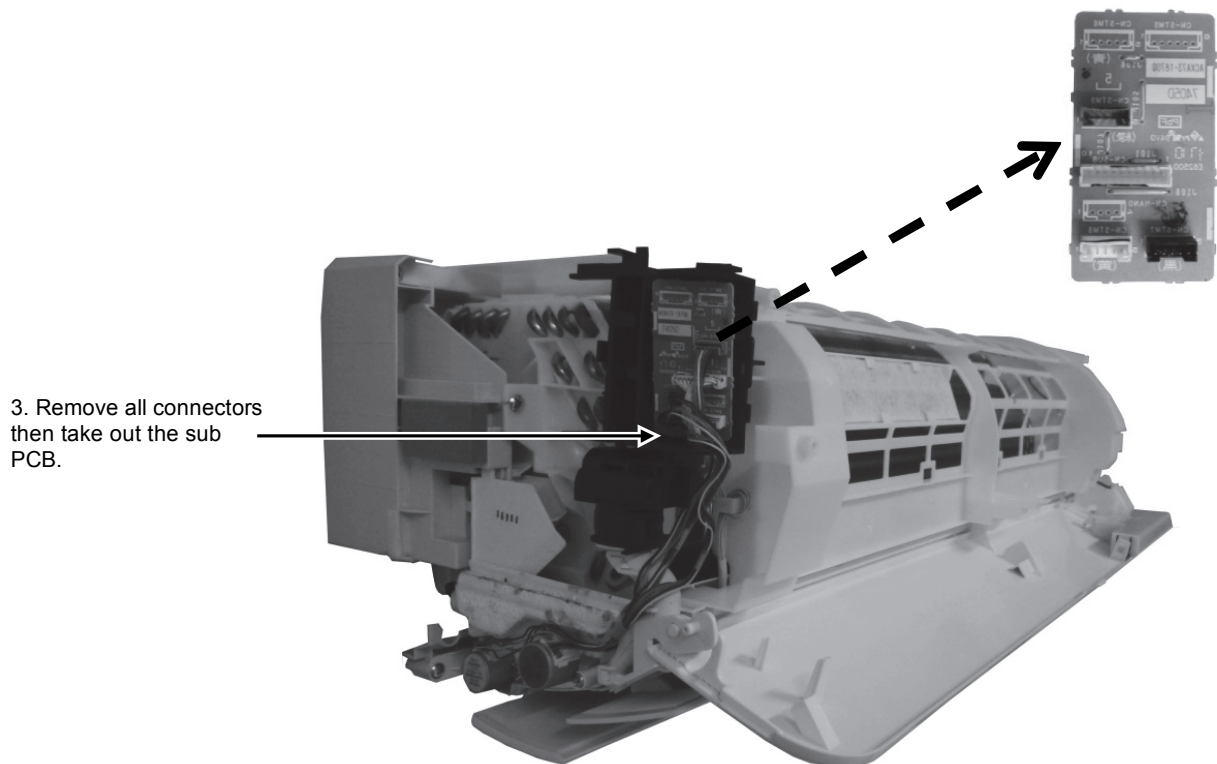

Figure 14

18.1.5 Discharge Grille Complete Removal Procedures

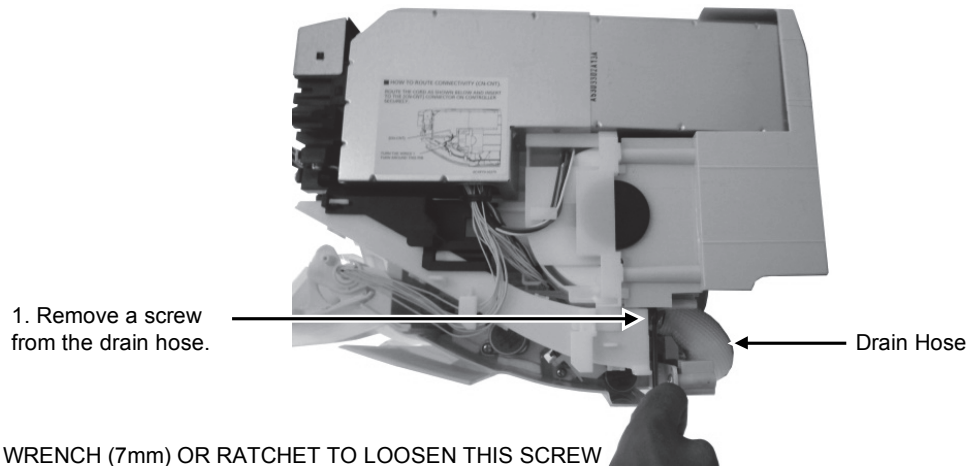

Figure 15

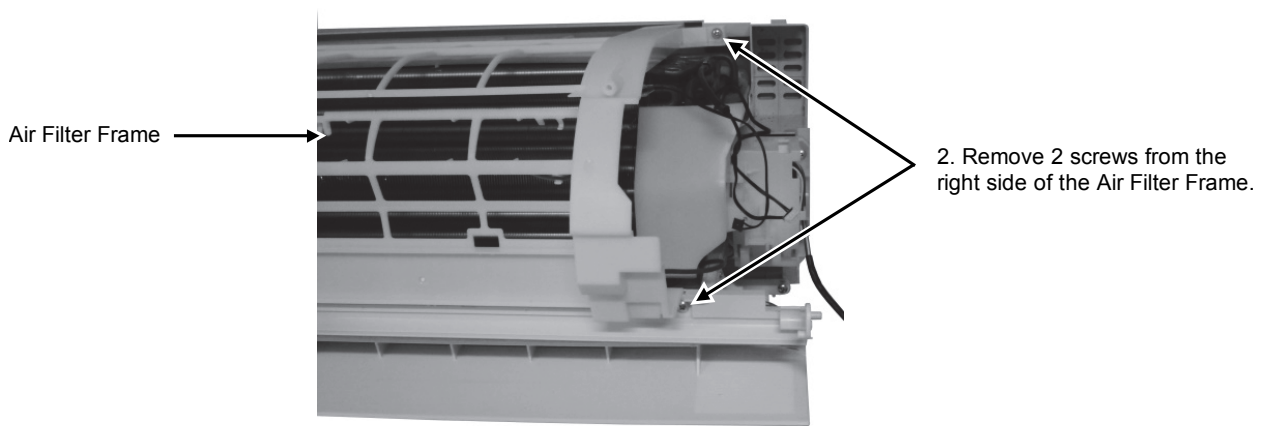

Figure 16

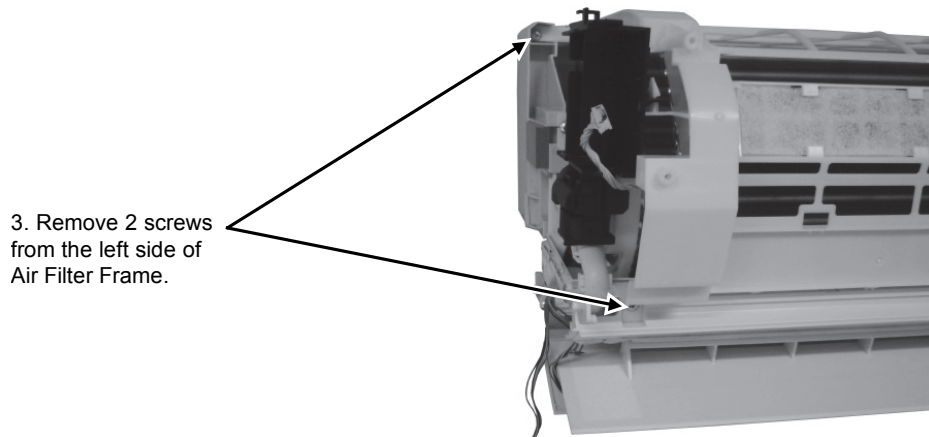

Figure 17

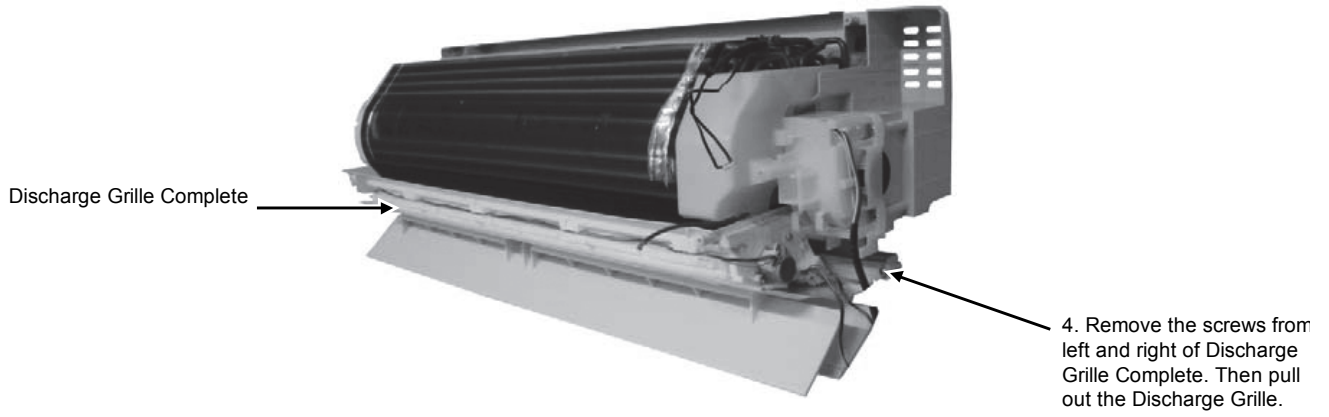

Figure 18

18.1.6 Cross-Flow Fan Removal Procedures

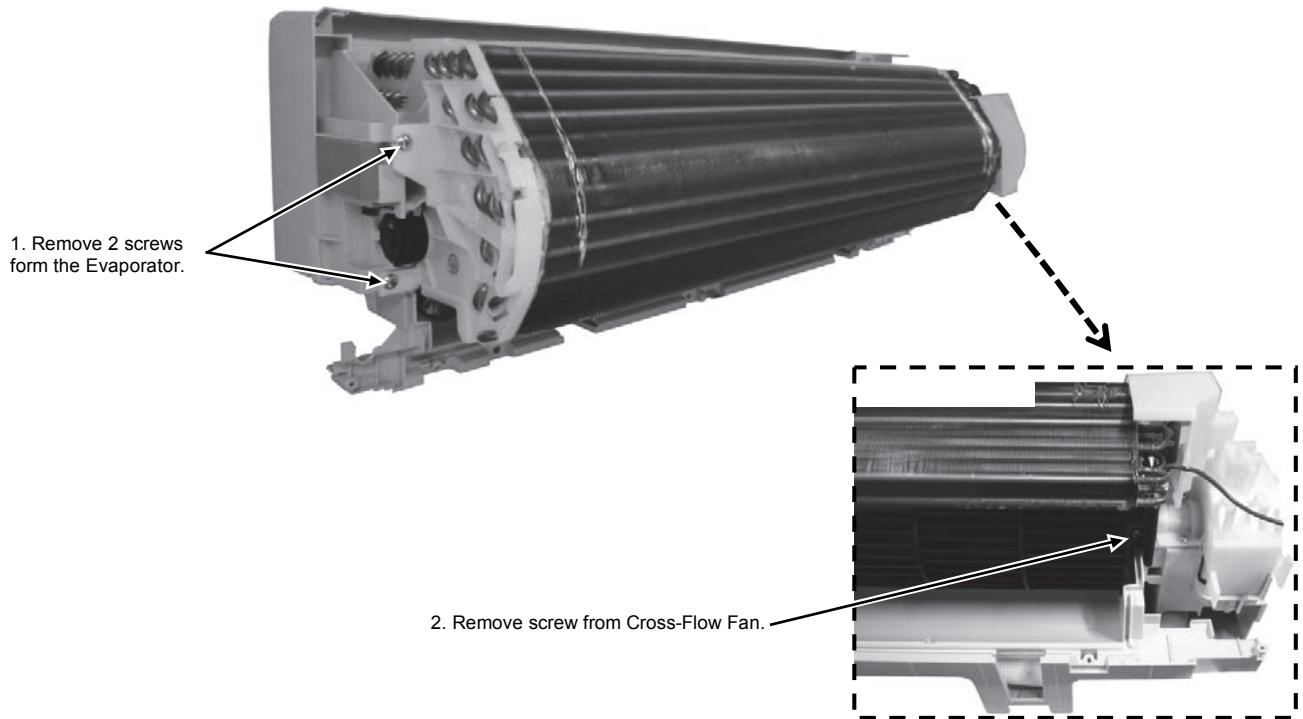

Figure 19

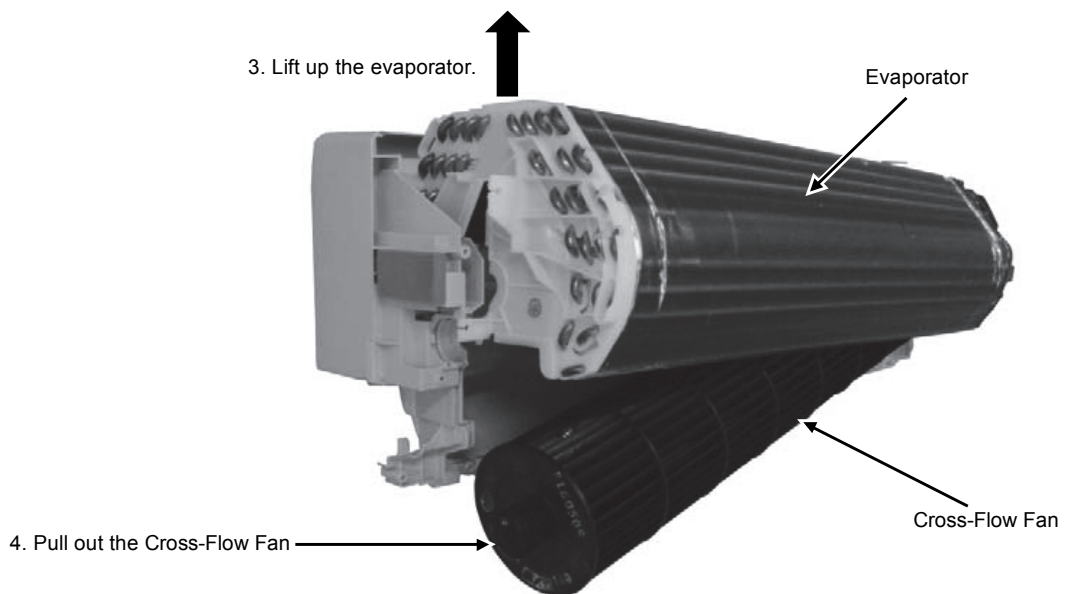

Figure 20

18.1.7 Fan Motor Removal Procedures

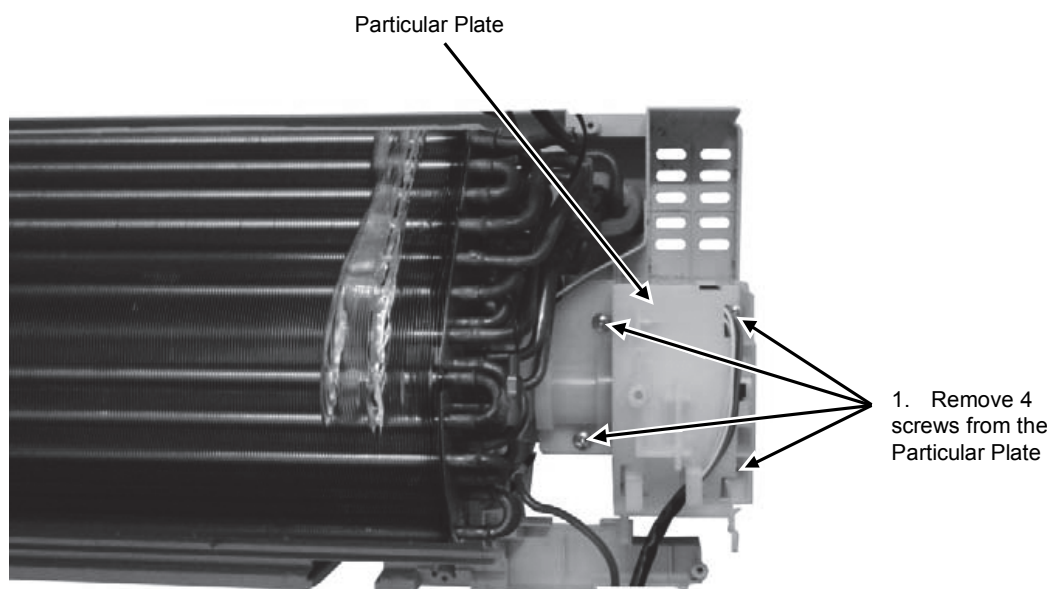

Figure 21

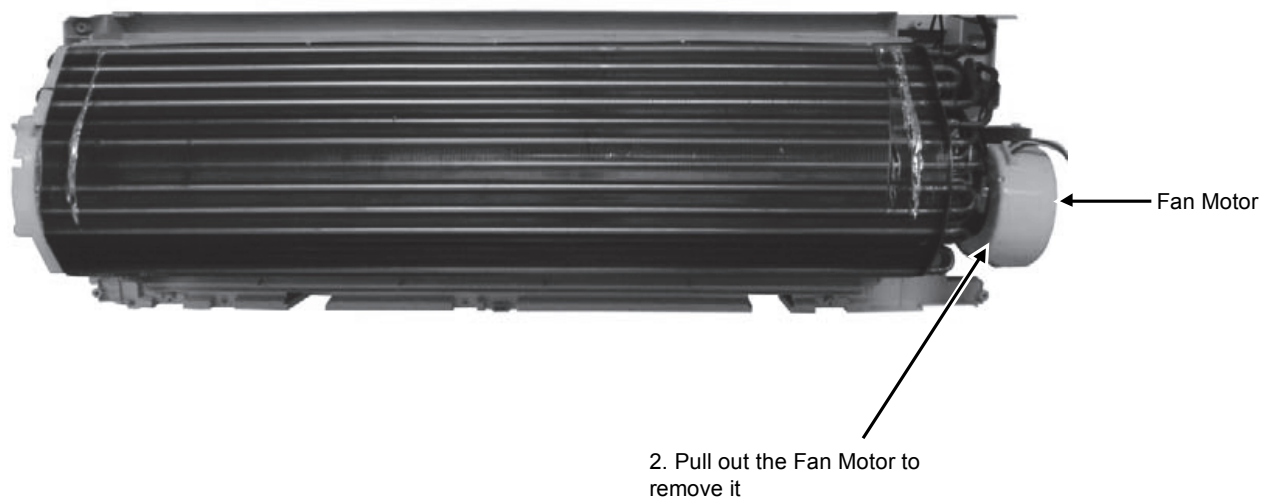

Figure 22

18.2 Outdoor Electronic Controller Removal Procedure

⚠ Caution! When handling electronic controller, be careful of electrostatic discharge.

- 1 Remove the 5 screws of the Top Panel.

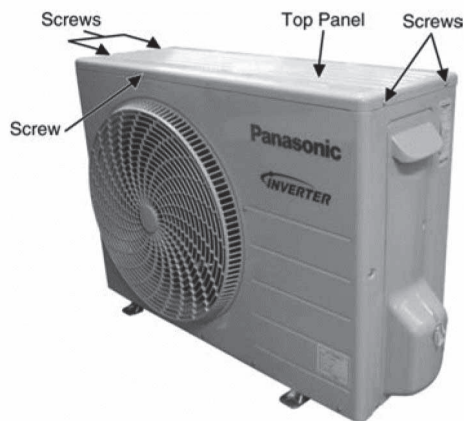

Fig. 1

- 2 Remove the 8 screws of the Front Panel.

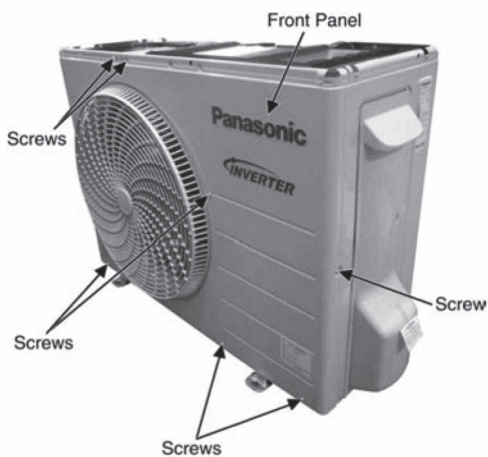

Fig. 2

- 3 Remove the screw of the Terminal Board Cover.
- 4 Remove the Top Cover of the Control Board by 4 hooks.

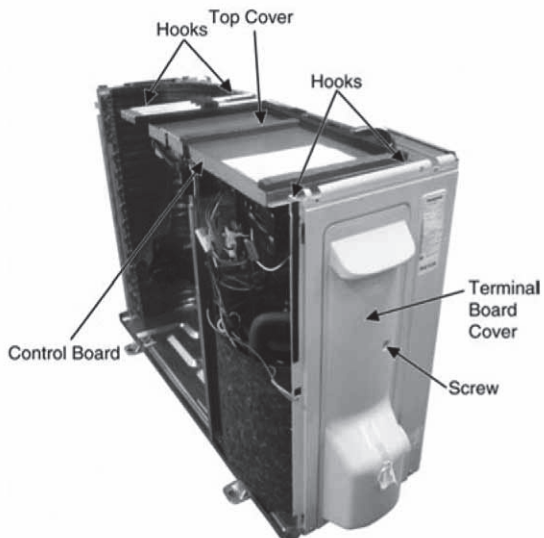

Fig. 3

- 5 Remove the Control Board as follows:

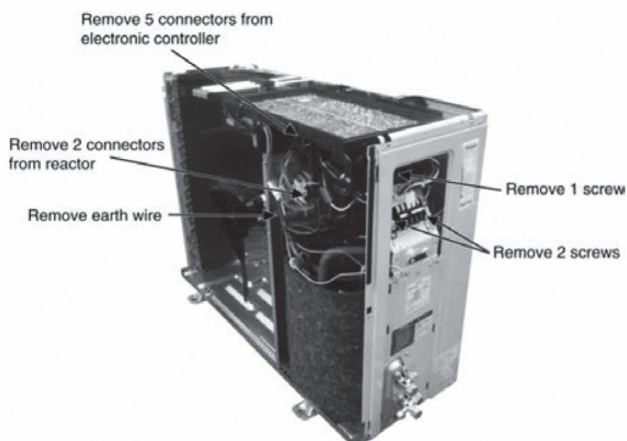

Fig. 4

Remove the Terminal Cover and 3 Terminal Compressor

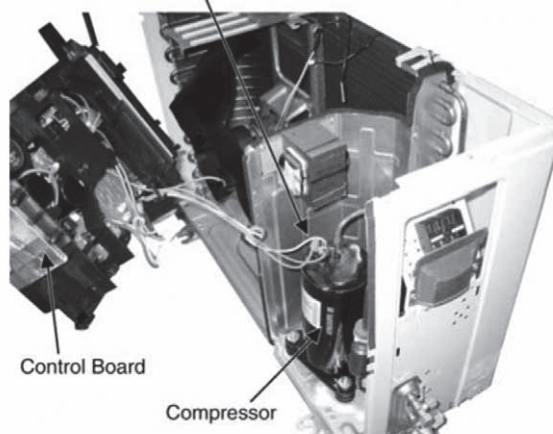

Fig. 5

Electronic Controller Control Board

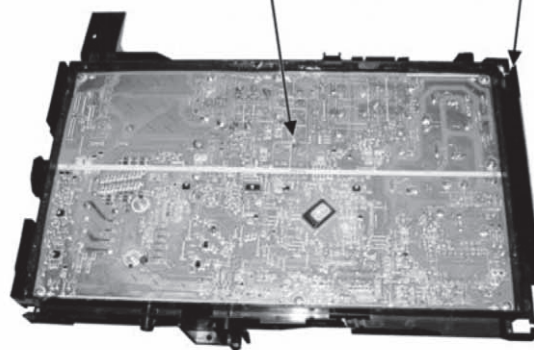

Fig. 6

19. Technical Data

Technical data provided are based on the air conditioner running under free frequency.

19.1 Cool Mode Performance Data

Unit setting: Standard piping length, Hi Fan, Cool mode at 16°C

Voltage: 230V

19.1.1 CS-LZ25TKE CU- LZ25TKE

Indoor (°C)		Outdoor DB (°C)											
DB	WB	-15			-7			0			5		
		TC	SHC	IP	TC	SHC	IP	TC	SHC	IP	TC	SHC	IP
27	19.0	2308	1807	115	2828	2057	230	2688	1874	232	2813	1347	326
	22.0	2453	1331	115	3055	1465	165	3027	1457	201	3242	1320	323
23	15.7	2080	1715	101	1850	1541	138	2531	2037	256	2639	1416	314
	18.4	2132	1256	108	1372	707	121	2662	1300	223	2901	1269	325
20	13.3	1847	1563	108	1690	1474	136	1906	1567	125	2061	1655	204
	15.8	1913	1218	110	1718	1140	119	2394	1375	250	2651	1228	334

Indoor (°C)		Outdoor DB (°C)								
DB	WB	16			25			35		
		TC	SHC	IP	TC	SHC	IP	TC	SHC	IP
27	19.0	2953	1930	297	2764	1790	392	2500	2063	505
	22.0	3336	1493	287	3040	1732	394	2826	1362	508
23	15.7	2694	1918	305	2504	1837	394	2292	1661	501
	18.4	2916	1585	300	2746	1522	391	2435	1359	505
20	13.3	2098	1693	206	2383	1875	394	2123	1630	497
	15.8	2730	1578	303	2581	1549	392	2289	1403	501

(Dry bulb value based on 46% humidity)

19.1.2 CS-LZ35TKE CU- LZ35TKE

Indoor (°C)		Outdoor DB (°C)											
DB	WB	-15			-7			0			5		
		TC	SHC	IP	TC	SHC	IP	TC	SHC	IP	TC	SHC	IP
27	19.0	3231	2529	195	3959	2879	389	3763	2624	393	3938	1886	551
	22.0	3434	1864	196	4277	2052	280	4238	2040	341	4539	1848	547
23	15.7	2913	2401	171	2591	2157	234	3544	2852	434	3695	1982	532
	18.4	2985	1759	183	1921	990	205	3727	1820	377	4061	1776	550
20	13.3	2586	2189	182	2365	2063	230	2669	2193	212	2885	2317	346
	15.8	2679	1706	186	2405	1596	201	3351	1925	424	3711	1719	565

Indoor (°C)		Outdoor DB (°C)								
DB	WB	16			25			35		
		TC	SHC	IP	TC	SHC	IP	TC	SHC	IP
27	19.0	4134	2702	502	3870	2506	663	3500	2506	855
	22.0	4670	2090	486	4257	2425	667	3956	1907	860
23	15.7	3771	2686	516	3506	2572	667	3209	2325	848
	18.4	4082	2219	508	3844	2131	663	3409	1903	855
20	13.3	2937	2371	349	3336	2625	667	2972	2282	842
	15.8	3821	2210	514	3614	2169	664	3204	1964	848

(Dry bulb value based on 46% humidity)

TC - Total Cooling Capacity (W)
 SHC - Sensible Heat Capacity (W)
 IP - Input Power (W)

19.2 Heat Mode Performance Data

Unit setting: Standard piping length, Hi Fan, Heat mode at 30°C
Voltage: 230V

19.2.1 CS-LZ25TKE CU- LZ25TKE

Indoor (°C)	Outdoor WB (°C)									
	-20 / -21		-15 / -16		-7 / -8		2 / 1		7 / 6	
DB	TC	IP	TC	IP	TC	IP	TC	IP	TC	IP
	24	3056	1752	3726	1862	3609	1604	3908	1497	5183
20	3135	1649	3822	1752	3800	1555	4275	1489	5568	1735
16	3177	1587	3873	1686	3843	1472	4485	1499	5864	1733

Indoor (°C)	Outdoor WB (°C)	
	12 / 11	
DB	TC	IP
24	5462	1709
20	5859	1730
16	6233	1732

19.2.2 CS-LZ35TKE CU- LZ35TKE

Indoor (°C)	Outdoor WB (°C)									
	-20 / -21		-15 / -16		-7 / -8		2 / 1		7 / 6	
DB	TC	IP	TC	IP	TC	IP	TC	IP	TC	IP
	24	3426	1975	4156	2094	4151	1978	4558	1946	6054
20	3515	1859.46	4263	1972	4370	1918	4986	1935	6503	2182
16	3562	1789	4320	1897	4420	1815	5230	1949	6849	2180

Indoor (°C)	Outdoor WB (°C)	
	12 / 11	
DB	TC	IP
24	6380	2150
20	6843	2176
16	7279	2179

TC - Total Cooling Capacity (W)
SHC - Sensible Heat Capacity (W)
IP - Input Power (W)

20. Service Data

Service data provided are based on the air conditioner running under rated frequency during forced cooling / forced heating mode.

20.1 Cool Mode Outdoor Air Temperature Characteristic

Condition

- Room Temperature: 27/19°C, Cooling Characteristic
- Fan: High
- Piping Length: 5.0m
- Freq: Rated Fc

20.1.1 CS-LZ25TKE CU-LZ25TKE

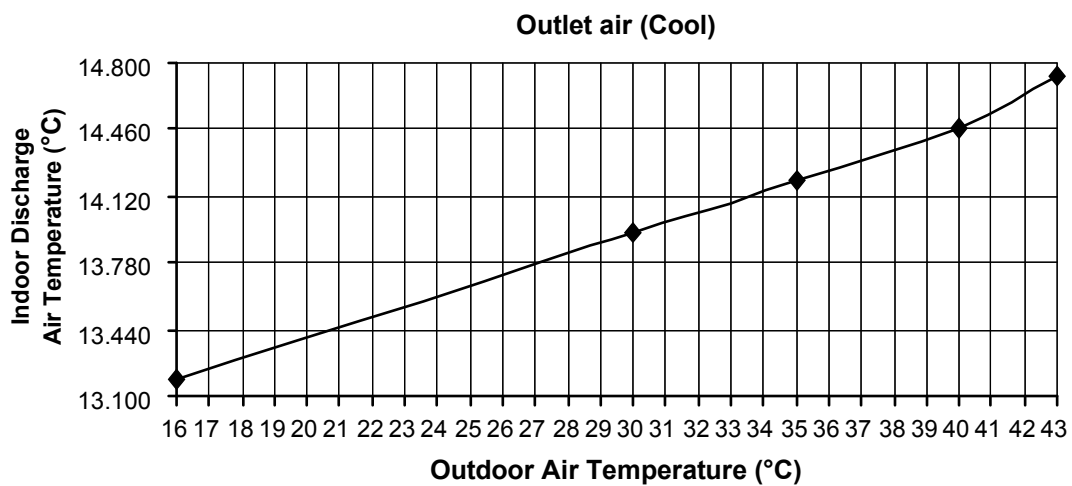
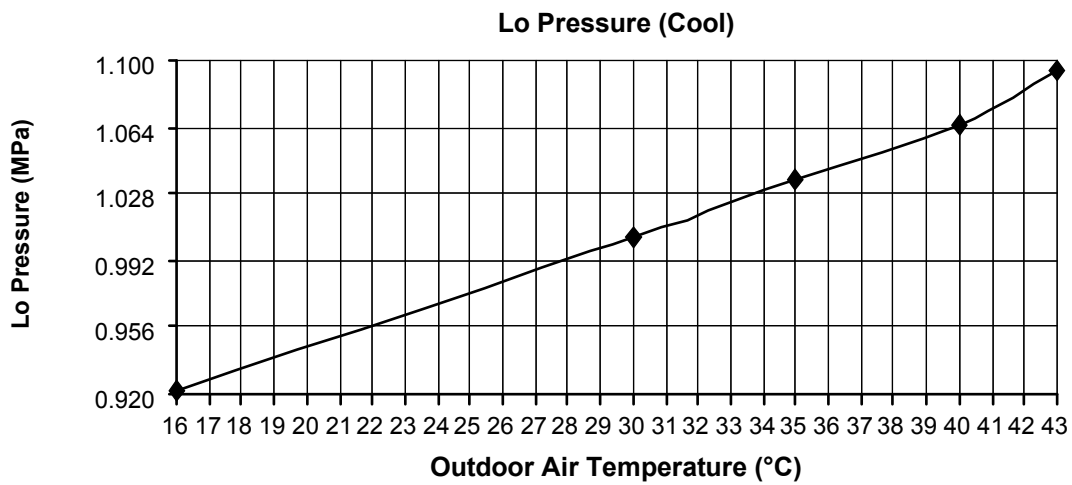
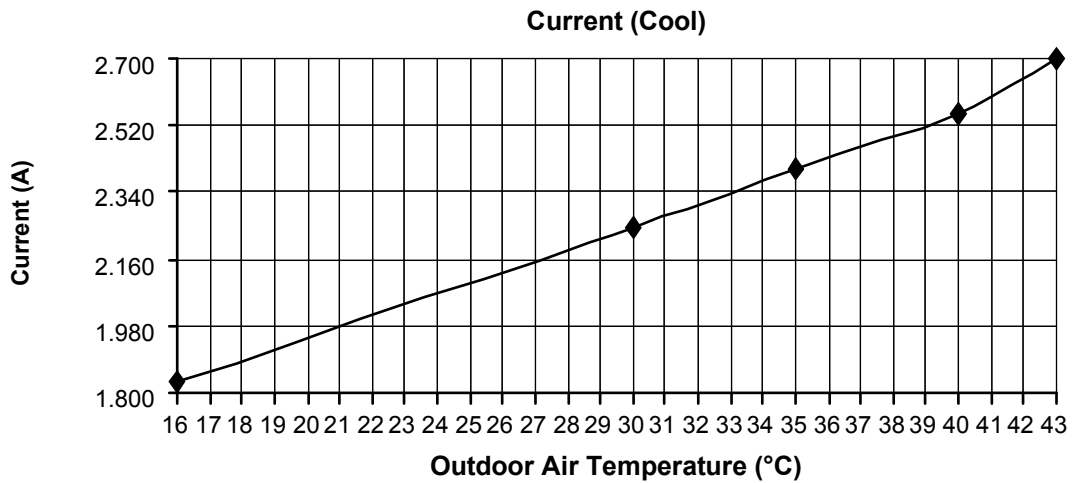

20.1.2 CS-LZ35TKE CU-LZ35TKE

Current (Cool)

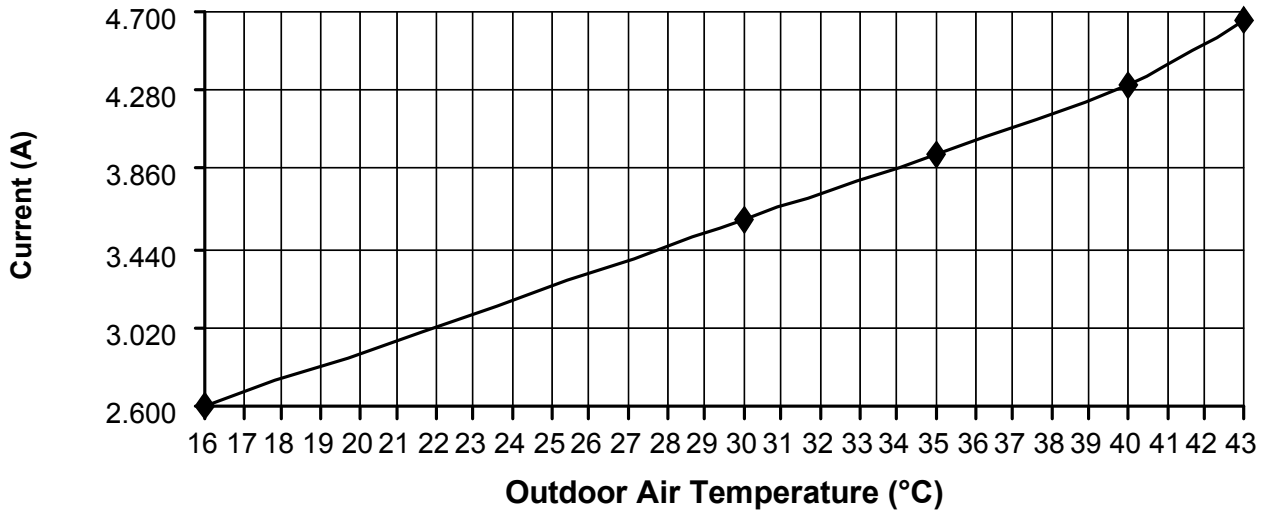

Lo Pressure (Cool)

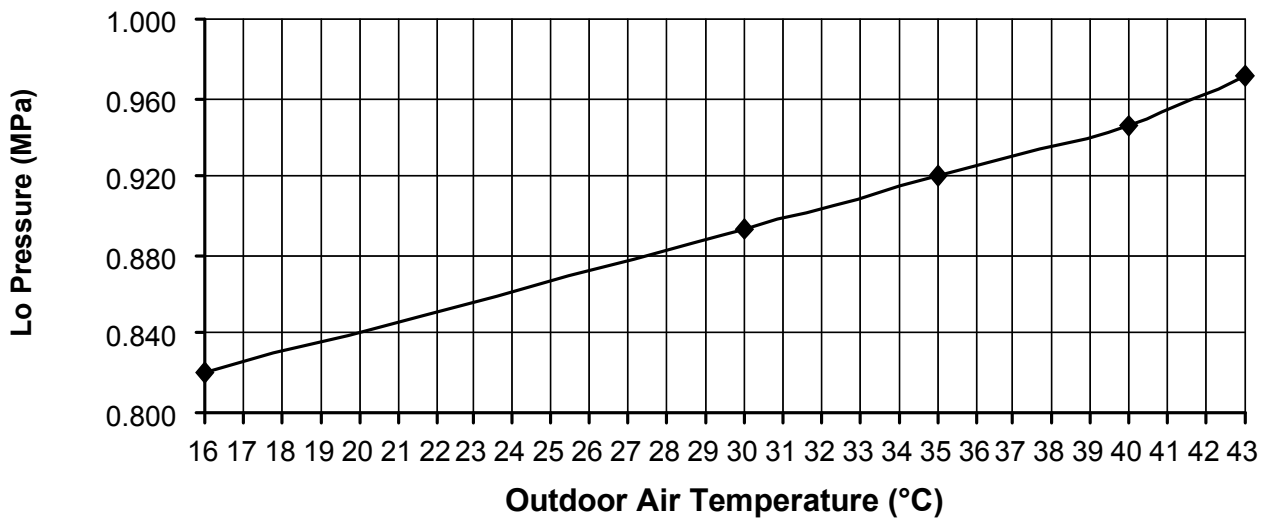

Outlet Air (Cool)

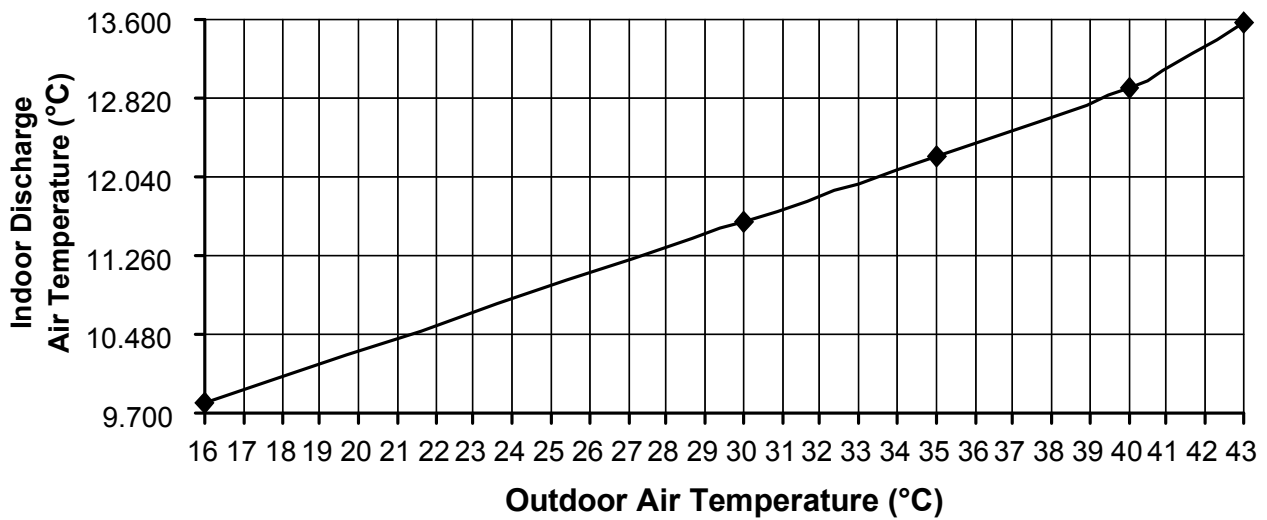

20.2 Heat Mode Outdoor Air Temperature Characteristic

Condition

- Room Temperature: 20°C, Heating Characteristic
- Fan: High
- Piping Length: 5.0m
- Freq: Rated Fh

20.2.1 CS-LZ25TKE CU-LZ25TKE

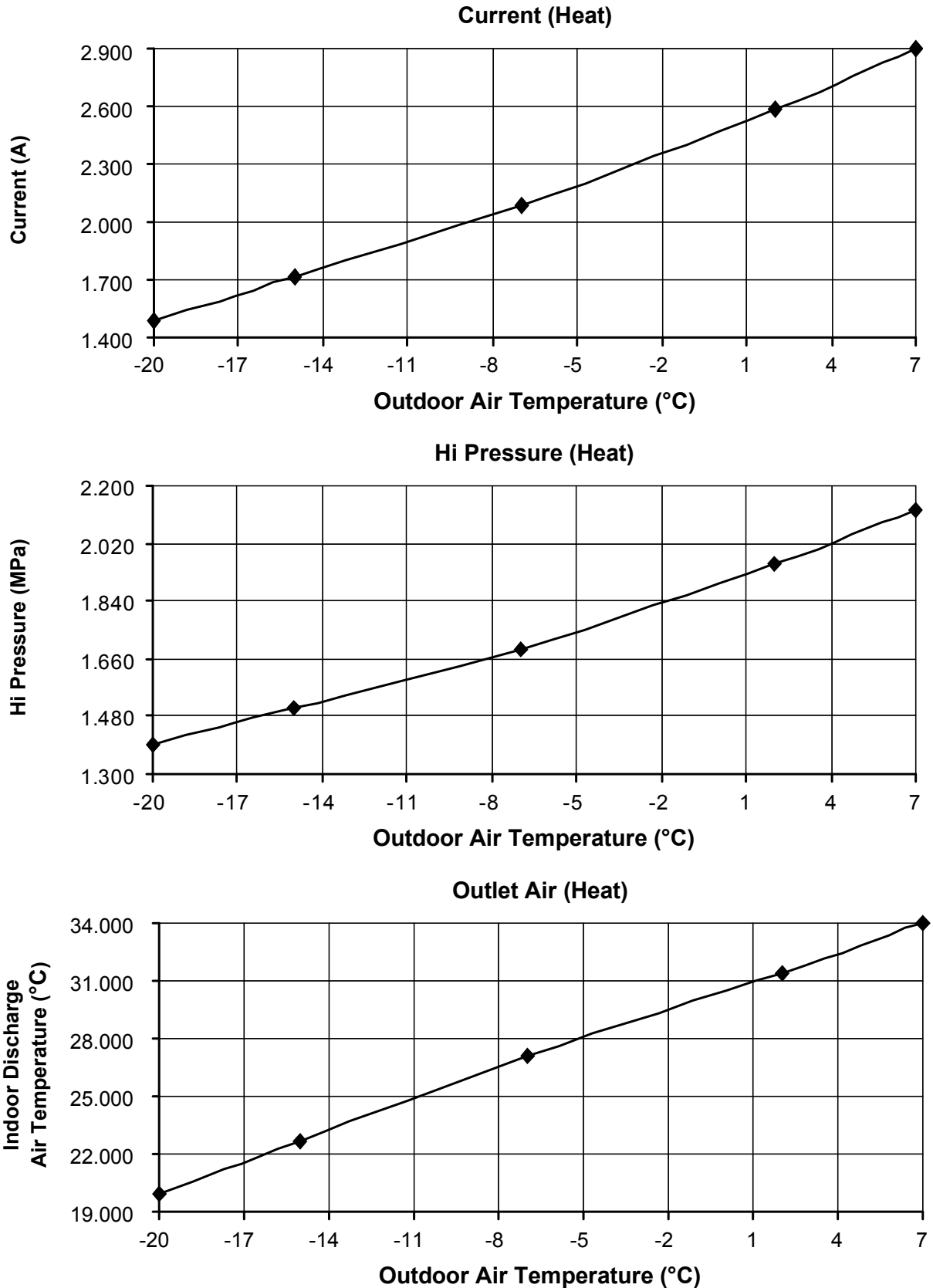

20.2.2 CS-LZ35TKE CU-LZ35TKE

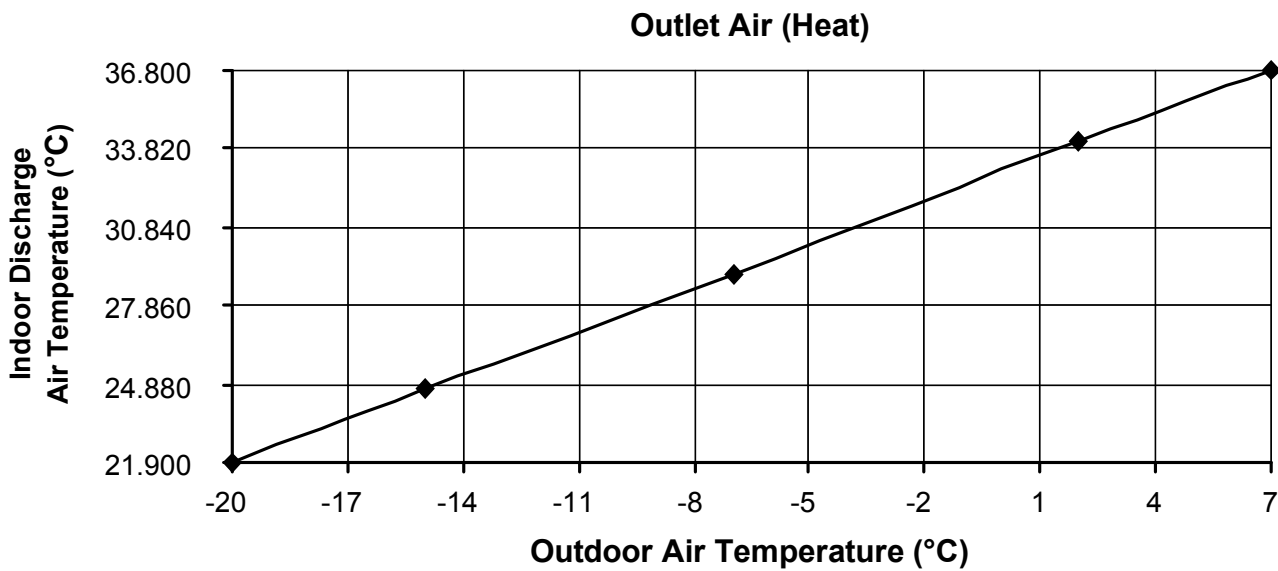
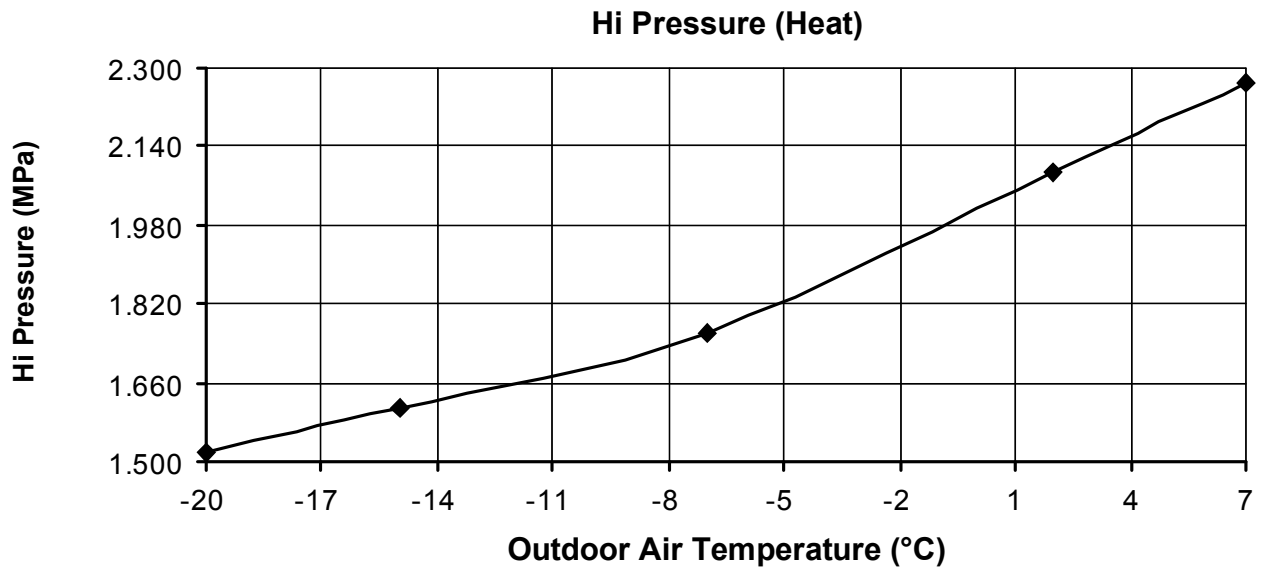
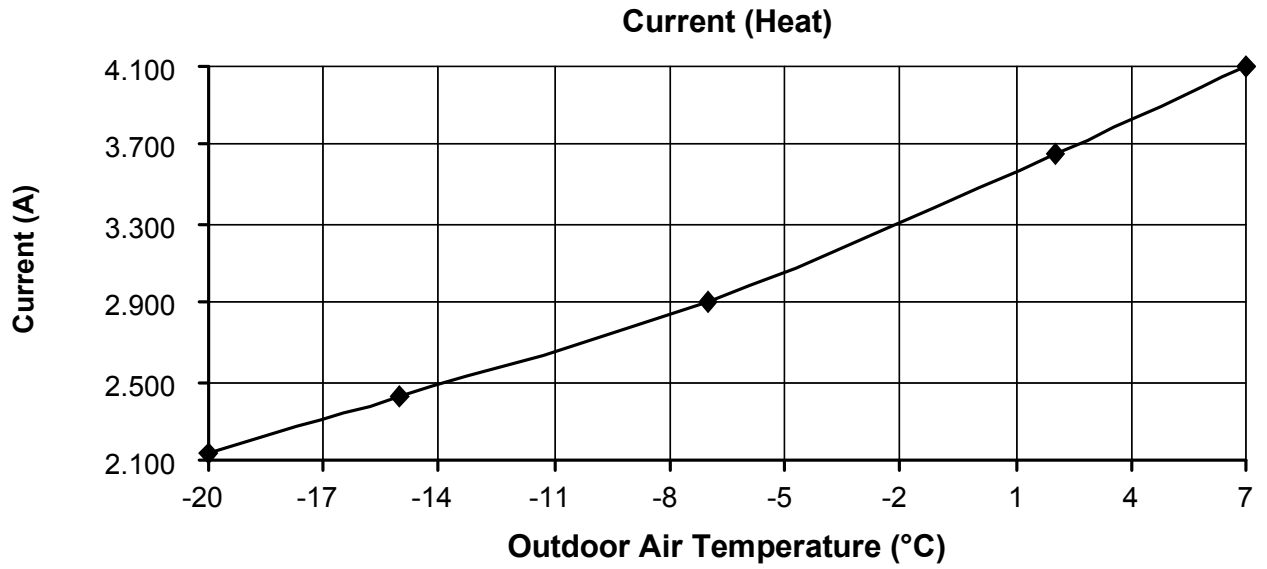

20.3 Piping Length Correction Factor

The characteristic of the unit has to be corrected in accordance with the piping length.

20.3.1 CS-LZ25TKE CU-LZ25TKE CS-LZ35TKE CU-LZ35TKE

Cooling Capacity

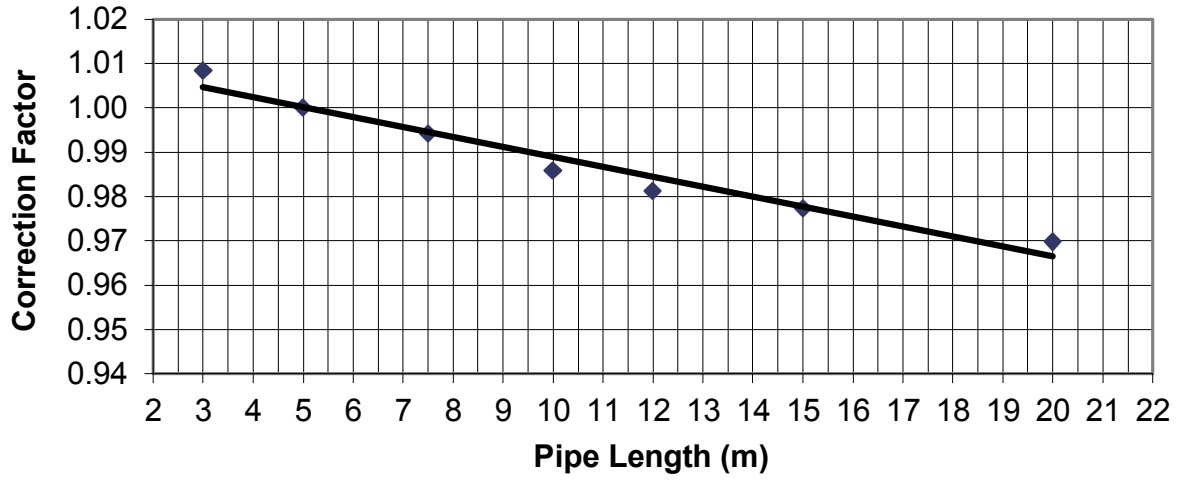

Heating Capacity

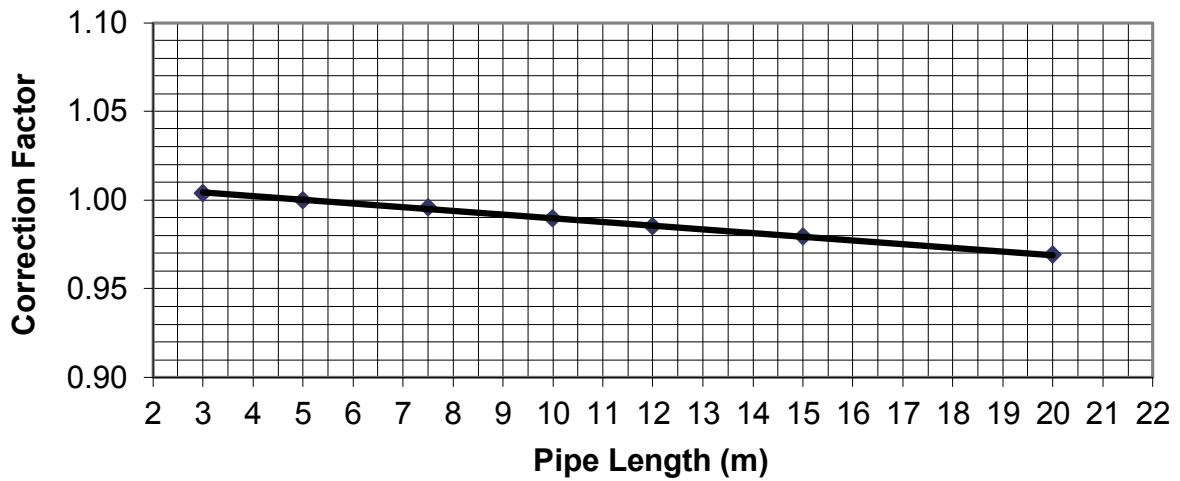

Note: The graphs show the factor after added right amount of additional refrigerant.

21. Exploded View and Replacement Parts List

21.1 Indoor Unit

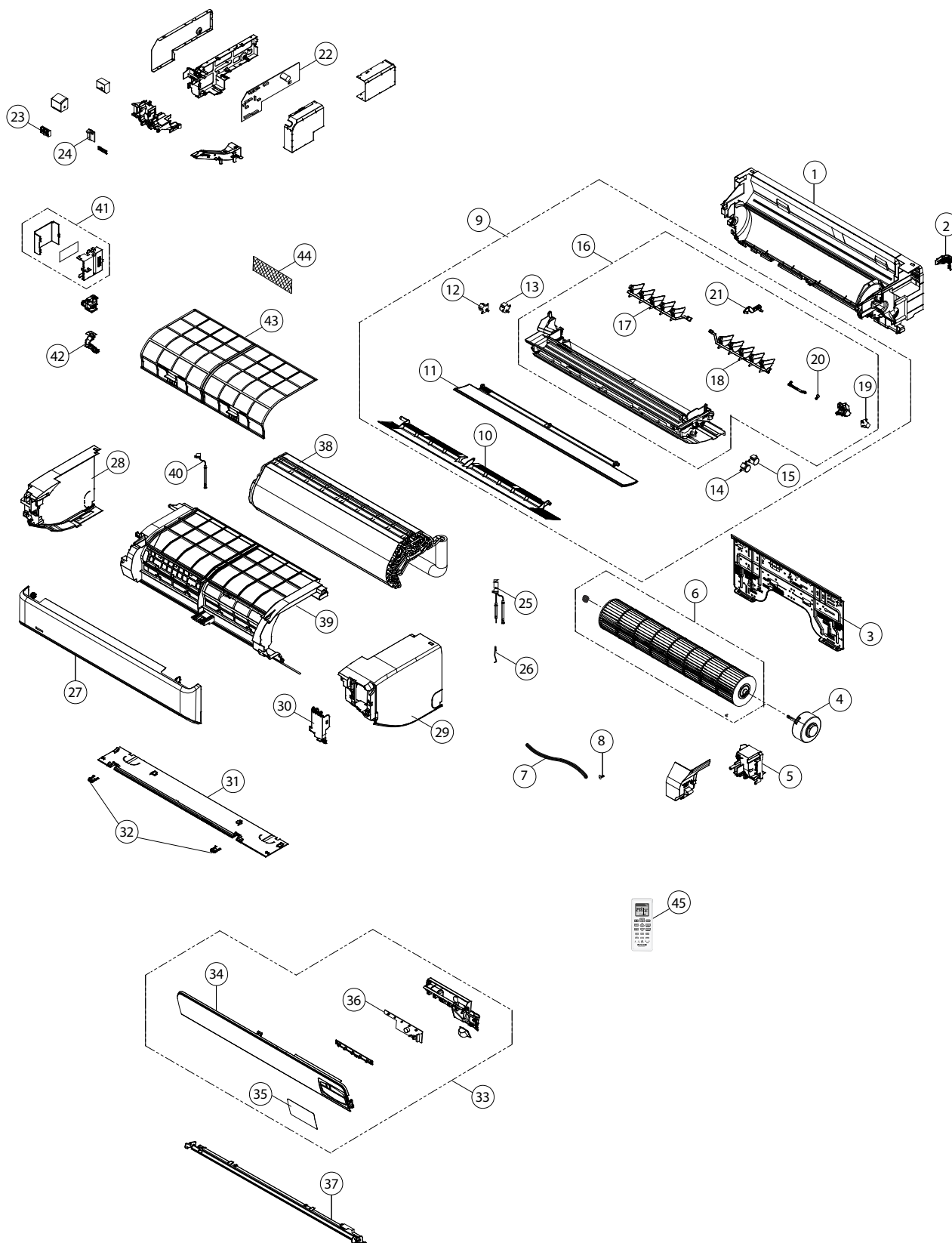

Note
The above exploded view is for the purpose of parts disassembly and replacement.
The non-numbered parts are not kept as standard service parts.

SAFETY	REF. NO.	PART NAME & DESCRIPTION	Qty	CS-LZ25TKE	CS-LZ35TKE	REMARK
	1	CHASSIS COMPLETE	1	ACXD50C00190	←	
	2	PARTICULAR PIECE	1	CWD933989	←	
	3	INSTALLATION PLATE	1	ACXH36-00010	←	
⚠	4	FAN MOTOR	1	L6CBYYL0227	←	O
	5	PARTICULAR PLATE - FAN MOTOR	1	ACXD90-00030-B	←	
	6	CROSS - FLOW FAN COMPLETE	2	ACXH02C00130	←	
	7	DRAIN HOSE	1	CWH851219	←	
	8	SCREW (DRAIN HOSE)	1	CWH551422	←	
	9	DISCHARGE GRILLE COMPLETE	1	ACXE20C00690	←	
	10	HORIZONTAL VANE - UPPER	1	ACXE24C00780	←	
	11	HORIZONTAL - BOTTOM	1	ACXE24C02460	←	
⚠	12	STEPPING MOTOR	1	L6JAYYYH0097	←	O
⚠	13	STEPPING MOTOR	1	L6JAYYYH0098	←	O
⚠	14	STEPPING MOTOR	1	L6JAYYYH0100	←	O
⚠	15	STEPPING MOTOR	1	L6JAYYYH0099	←	O
	16	DISCHARGE GRILLE COMPLETE	1	ACXE20C00700	←	
	17	VERTICAL VANE (LEFT)	1	ACXE24C00010	←	
	18	VERTICAL VANE (RIGHT)	1	ACXE24C00020	←	
⚠	19	STEPPING MOTOR (VERTICAL VANE)	1	L6JAYYYH0079	←	O
	20	CAP DRAIN TRAY	1	CWH521096	←	
	21	FULCRUM	1	ACXH62-00030	←	
⚠	22	ELECTRONIC CONTROLLER - MAIN	1	ACXA73-18321	←	O
	23	TERMINAL BOARD COMPLETE	1	ACXA28C03650	A28K1110J	O
⚠	24	ELECTRONIC CONTROLLER - SWITCH	1	ACXA73-18620	←	O
	25	SENSOR COMPLETE	1	ACXA50C06740	←	O
	26	PLATE SPRING	1	CWH711019	←	
	27	INTAKE GRILLE COMPLETE	1	ACXE22C00650	←	
	28	FRONT GRILLE - COMPLETE (LEFT)	1	ACXE12C00510	←	
	29	FRONT GRILLE - COMPLETE (RIGHT)	1	ACXE12C00500	←	
	30	GRILLE DOOR	1	ACXE14C00510	←	
	31	BOTTOM PLATE	1	ACXD90-08020	←	
	32	CAP	1	ACXH52-00010	←	
	33	PARTICULAR PLATE COMPLETE	1	ACXD90C01680	←	
	34	DECORATION BASE	1	ACXE35C01620	←	
	35	PROTECTION SHEET FOR SENSOR SECTION	1	ACXH86-00110	←	
	36	DISPLAY BOARD	1	ACXA73-18610-X	←	O
	37	PARTICULAR PIECE	1	ACXD93-00130-B	←	
	38	EVAPORATOR	1	ACXB30C10970	←	
	39	AIR FILTER FRAME	1	ACXD01C00690	←	
	40	SENSOR COMPLETE	1	ACXA50C06730	←	O

SAFETY	REF. NO.	PART NAME & DESCRIPTION	Qty	CS-LZ25TKE	CS-LZ35TKE	REMARK
	41	CONTROL BOARD COMPLETE - SUB	1	ACXH10C32360	←	
	42	DUCT - COMPLETE	1	ACXD22C00010-B	←	
	43	AIR FILTER	2	CWD001307	←	
	44	AIR PURIFYING FILTER	1	CWD001274	←	
	45	REMOTE CONTROLLER	1	ACXA75C07870	←	O

(NOTE)

- All parts are supplied from PAPAGZ, China (Vendor Code: 00029059).
- "O" marked parts are recommended to be kept in stock.

21.2 Outdoor Unit

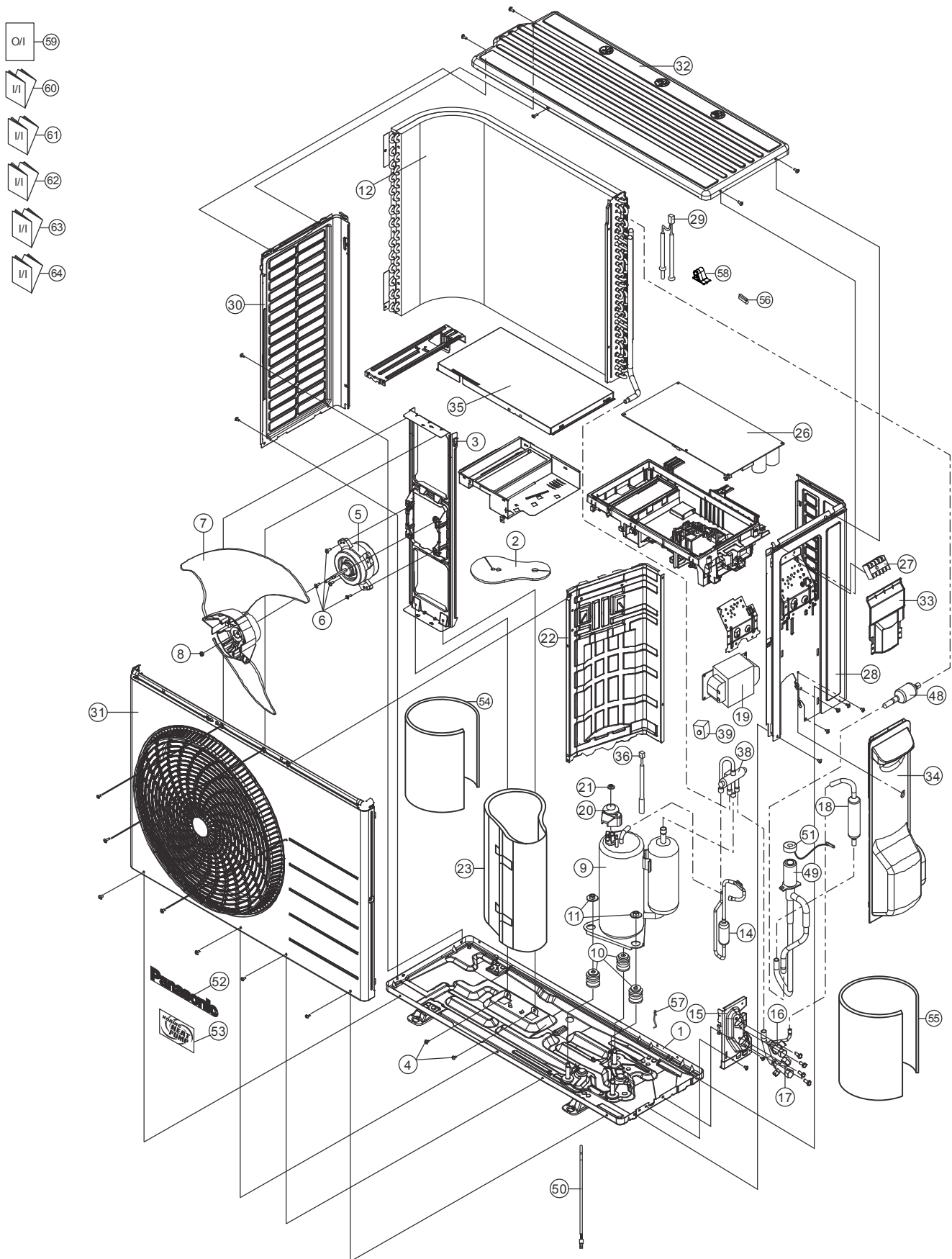

Note

The above exploded view is for the purpose of parts disassembly and replacement.
The non-numbered parts are not kept as standard service parts.

SAFETY	REF. NO.	PART NAME & DESCRIPTION	Qty	CU-LZ25TKE	CU-LZ35TKE	REMARK
	1	CHASSY ASS'Y	1	CWD52K1359	←	
	2	SOUND PROOF MATERIAL (TOP)	1	CWG302630	←	
	3	FAN MOTOR BRACKET	1	CWD541167	←	O
	4	SCREW - FAN MOTOR BRACKET	2	CWH551217	←	
⚠	5	FAN MOTOR, DC 40W 3PH	1	L6CAYYYL0049	←	
	6	SCREW - FAN MOTOR MOUNT	4	CWH55252J	←	
	7	PROPELLER FAN ASSY	1	CWH03K1066	←	
	8	NUT - PROPELLER FAN	1	CWH56053J	←	
⚠	9	COMPRESSOR	1	9RD132XAB21	←	O
	10	ANTI - VIBRATION BUSHING	3	CWH50077	←	
	11	NUT - COMPRESSOR MOUNT	3	CWH561096	←	
	12	CONDENSER COMPLETE	1	CWB32C4300	←	
	14	DISCHARGE MUFFLER	1	CWB121010	←	O
	15	HOLDER - COUPLING	1	CWH351233	←	
	16	2 - WAYS VALVE	1	CWB021589	←	O
	17	3 - WAYS VALVE	1	CWB011374	←	O
	18	ACCUMULATOR	1	CWB131065	←	
⚠	19	REACTOR	1	G0C193J00004	←	O
	20	TERMINAL COVER	1	CWH171039A	←	
	21	NUT - TERMINAL COVER	1	CWH7080300J	←	
	22	SOUND - PROOF BOARD	1	CWH151273	←	
	23	SOUND PROOF MATERIAL (COMP. BODY)	1	CWG302952	←	
⚠	26	ELECTRONIC CONTROLLER - MAIN	1	ACXA73C30280R	ACXA73C30290R	O
⚠	27	TERMINAL BOARD ASS'Y	1	CWA28K1110J	←	O
	28	CABINET SIDE PLATE CO.	1	CWE04C1481	←	
	29	SENSOR - CO. (CN-TH1 OUT & PIPING TEMP)	1	CWA50C3079	←	O
	30	CABINET SIDE PLATE (L)	1	CWE041616A	←	
	31	CABINET FRONT PLATE - CO.	1	CWE06C1441	←	
	32	CABINET TOP PLATE	1	CWE031148A	←	
	33	PLATE - C.B. COVER	1	CWH131470	←	
	34	CONTROL BOARD COVER - COMPLETE	1	CWH13C1253	←	
	35	CONTROL BOARD COVER - TOP	1	CWH131473	←	
	36	SENSOR - CO. (CN-TANK COMP TEMP)	1	CWA50C2894	←	O
	38	4 - WAYS VALVE	1	ACXB00-00130	←	O
⚠	39	V - COIL COMPLETE (4 WAY VALVE)	1	ACXA43C00250	←	O
	48	STRAINER	1	CWB11094	←	O
	49	EXPANSION VALVE	1	CWB051078	←	O
	50	CRANKCASE HEATER	1	CWA341072	←	
⚠	51	V - COIL COMPLETE (EXPENSION VALVE)	1	CWA43C2603	←	O
	52	PANASONIC BADGE	1	CWE373439	←	
	53	NORDIC HEATPUMP LABEL	1	CWE373985	←	
	54	SOUND PROOF MATERIAL	1	CWG302740	←	
	55	SOUND PROOF MATERIAL	1	CWG302745	←	

SAFETY	REF. NO.	PART NAME & DESCRIPTION	Qty	CU-LZ25TKE	CU-LZ35TKE	REMARK
	56	HOLDER - SENSOR	1	CWH32075	←	
	57	HOLDER - SENSOR	1	CWH32143	←	
	58	HOLDER - SENSOR	1	CWH321113	←	
	59	OPERATING INSTRUCTION	1	ACXF55-11470	←	
	60	INSTALLATION INSTRUCTION	1	ACXF60-16960	←	
	61	INSTALLATION INSTRUCTION	1	ACXF60-16970	←	
	62	INSTALLATION INSTRUCTION	1	ACXF60-16980	←	
	63	INSTALLATION INSTRUCTION	1	ACXF60-16990	←	
	64	INSTALLATION INSTRUCTION	1	ACXF60-17000	←	

(NOTE)

- All parts are supplied from PAPAMY, Malaysia (Vendor Code: 00029488).
- “O” marked parts are recommended to be kept in stock.