

Mini Ground Spot LED
7478-000/EE

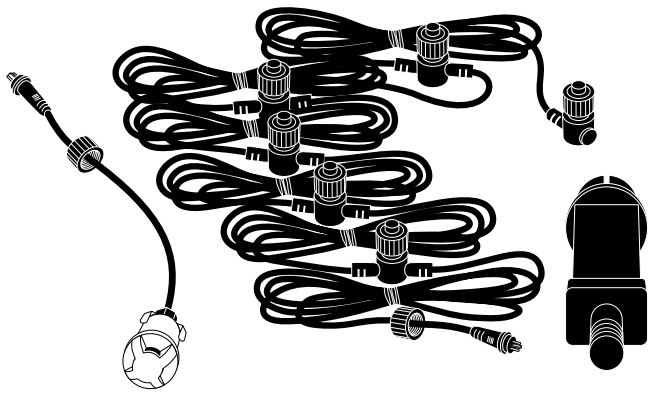

x6

1.

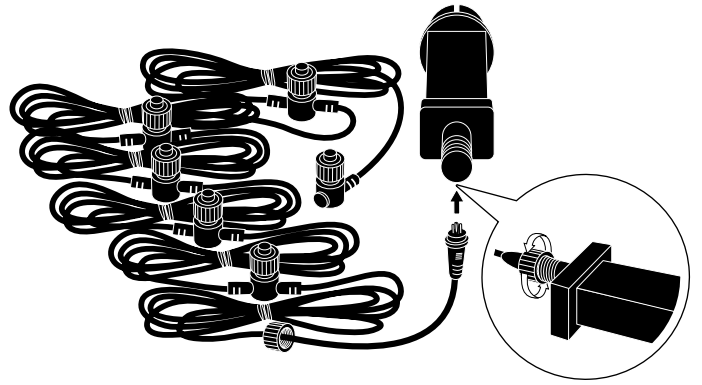

2.

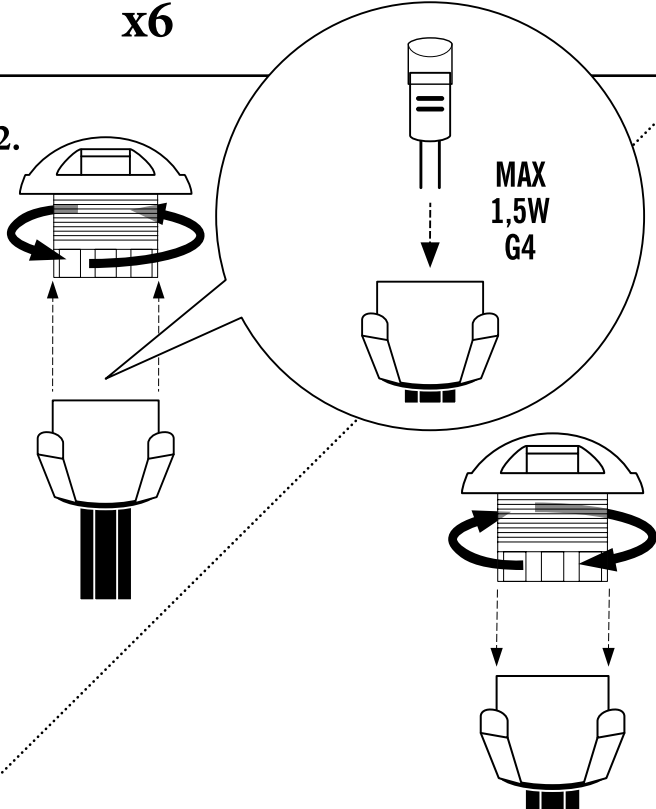

3.

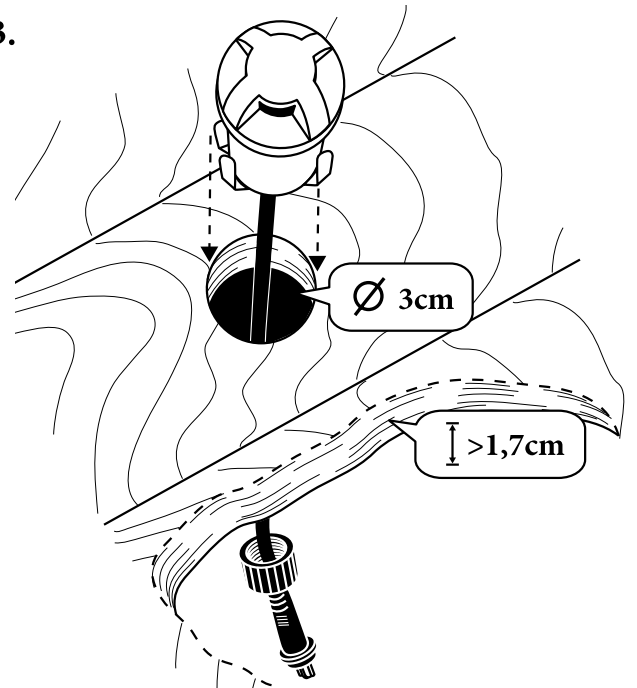

4.

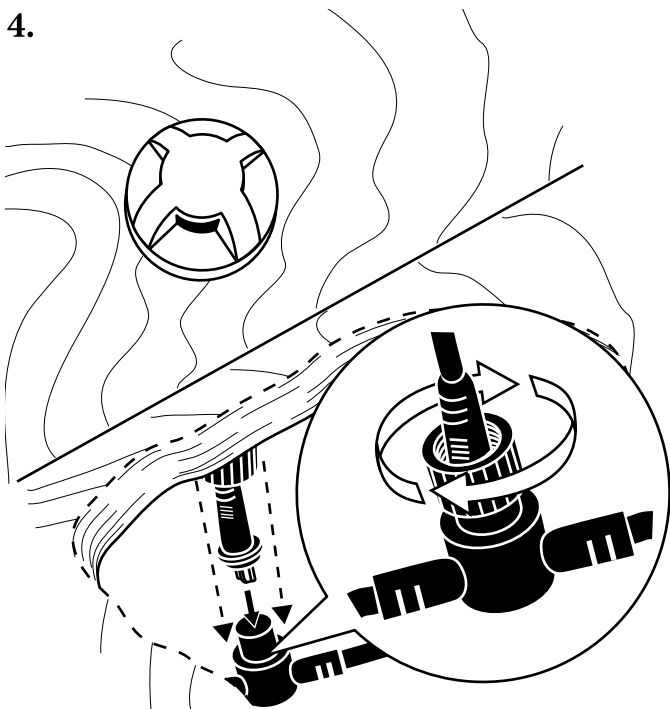

5.

