



# Lakka pihakivet ladontamalleja



## SISÄLTÖ

Agorakivet .....	s. 1
Antiikkikivi, Antiikkikivi puolikas, Antiikkilaatta, Miniantiikki .....	s. 4
Citykivi .....	s. 18
Citylaatta, Minicity .....	s. 19
H-kivi.....	s. 24
Klassikkokivi, Klassikko neliökivi, Klassikko kaarrekivi .....	s. 25
Loimukivet.....	s. 27
Mukulakivi .....	s. 32
Mukula Kaarresarja .....	s. 33
Nurmikivi .....	s. 34
Nupukivi, Pihakivi, Pihalaatta, Katukivi, Katulaatta .....	s. 35
Reikälaatta.....	s. 47
Roomalainen kivi 80 .....	s. 50
Roomankivet 60 .....	s. 61
Sauvakivi.....	s. 63
Unikivi.....	s. 64
Antiikki- ja Citymuurikivi .....	s. 66
Lohkomuurikivi.....	s. 69
Muurikivi .....	s. 72
Nurmikon reunakivi.....	s.73
Rasikivi.....	s. 74

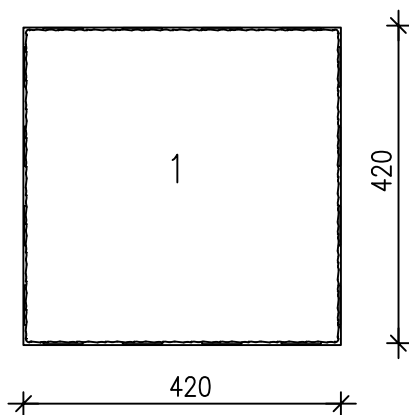

8 kpl / lava

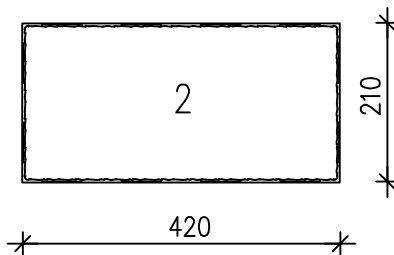

56 kpl / lava

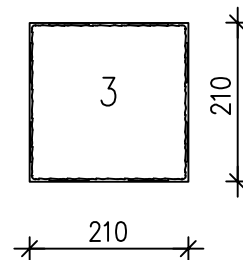

16 kpl / lava

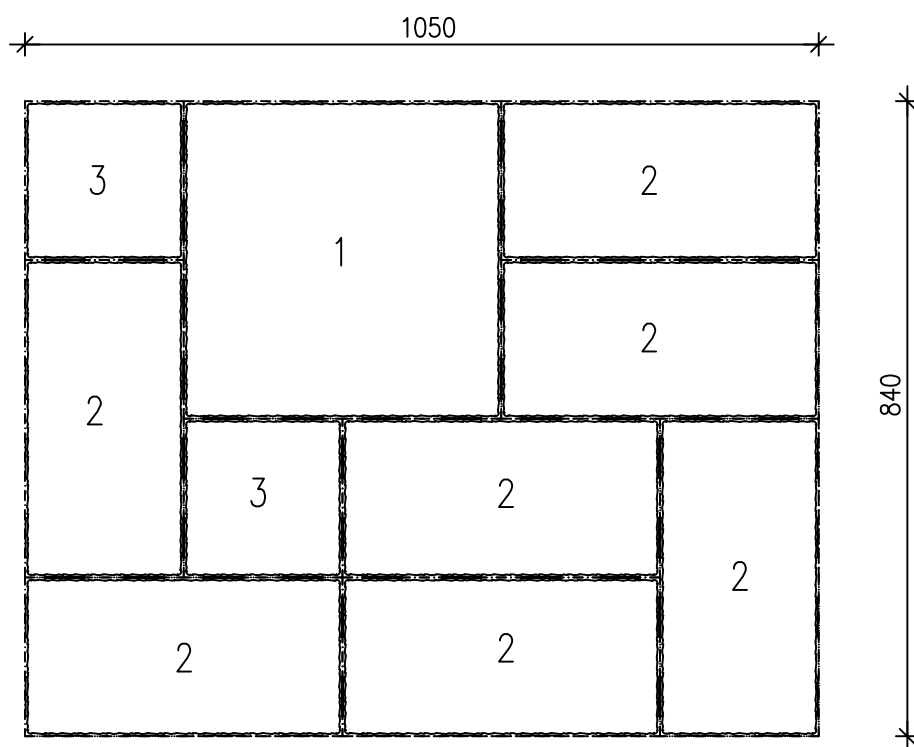

VALMIS LADONTAKUVIO LAVAKERROKSISSA 0,88 m<sup>2</sup>

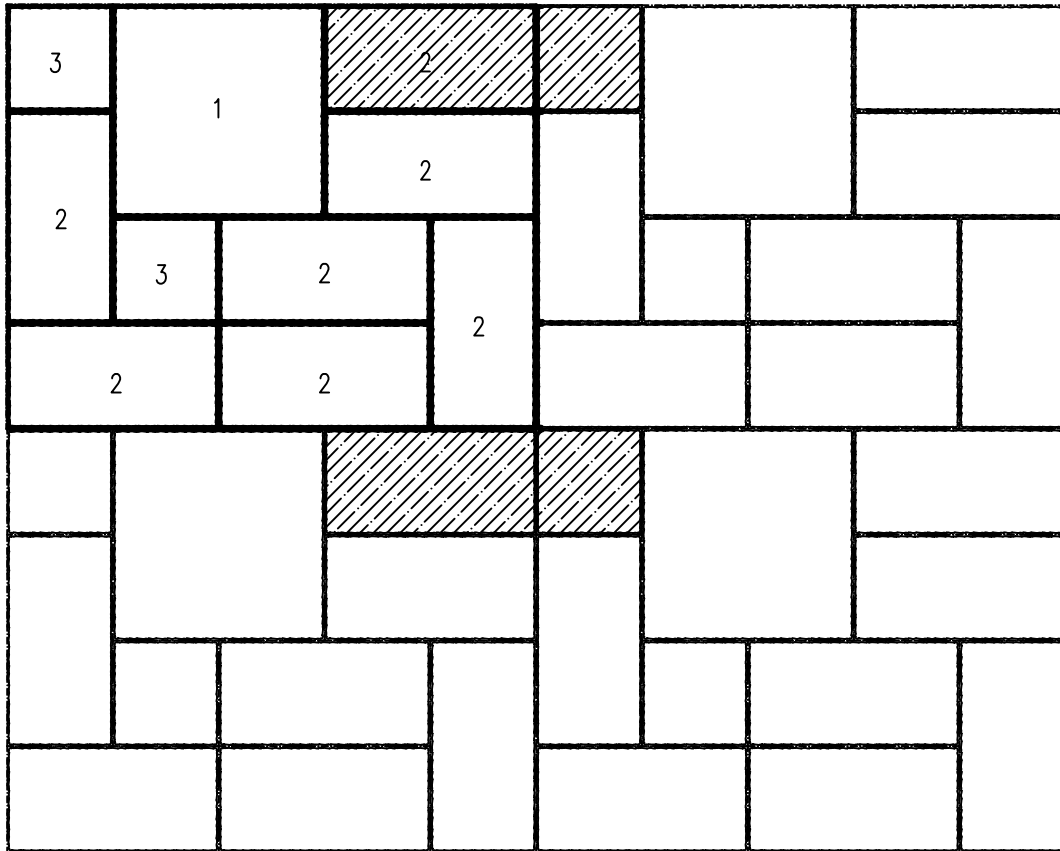

SUORAT PITKITTÄISSAUMAT VOIDAAN HÄVITTÄÄ VAIHTAMALLA TUMMENNETTUIJEN KIVIEN PAIKKAA KESKENÄÄN.

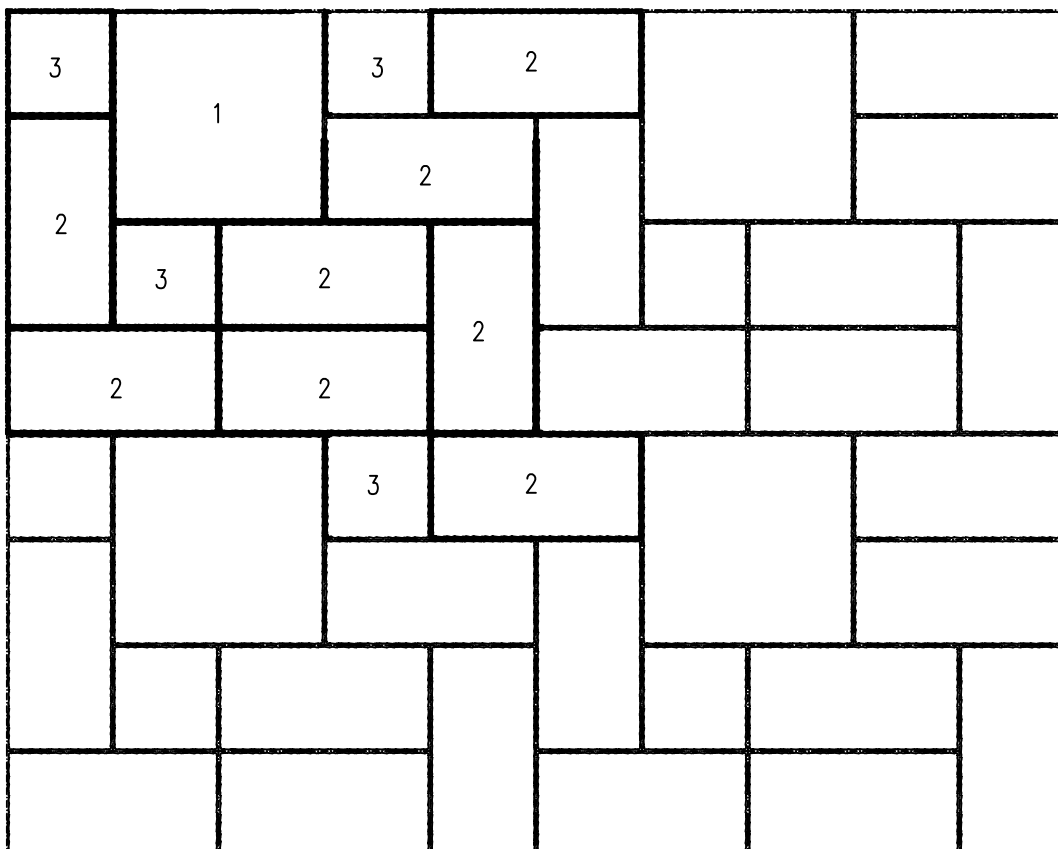



LADONTAMALLIT

LAKAN BETONI OY

1:15

KALANRUOTOLADONTA

27.4.2017

AGORAKIVET 80

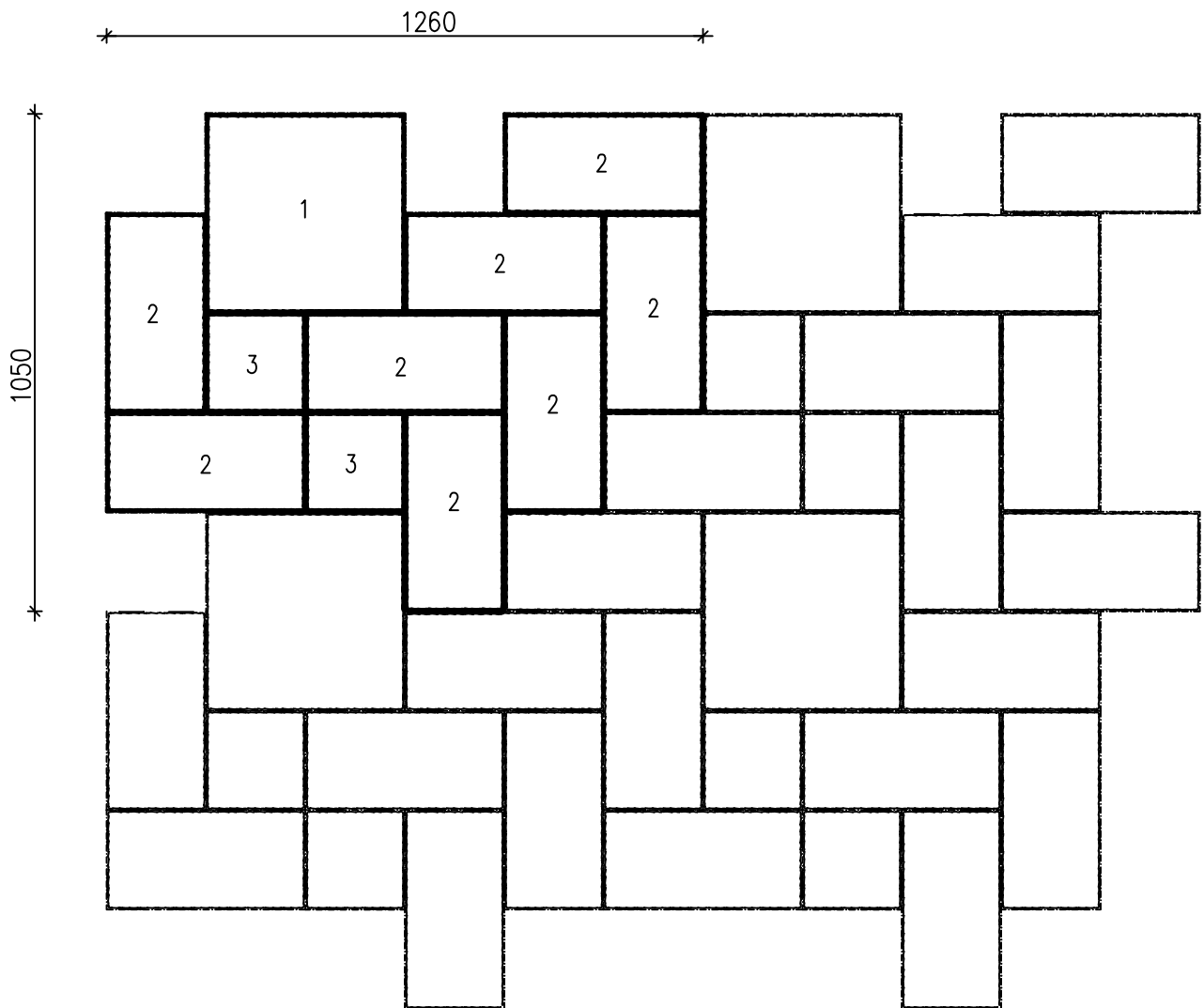

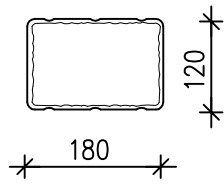
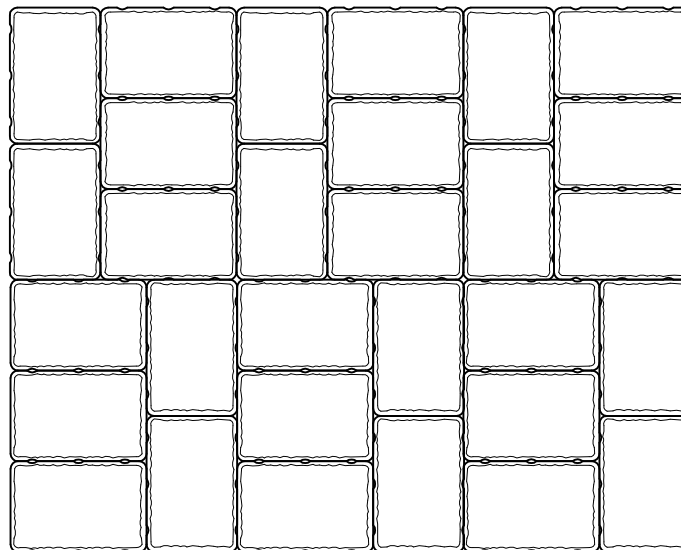
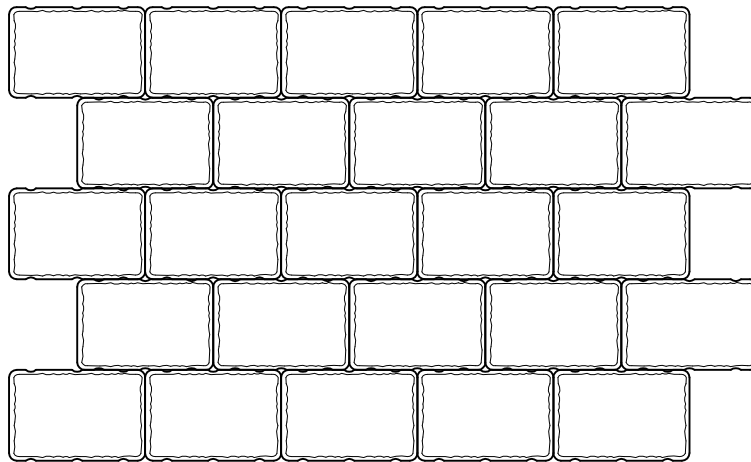
Menekki 46kpl/m<sup>2</sup>

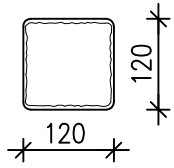

Menekki 71kpl/m<sup>2</sup>

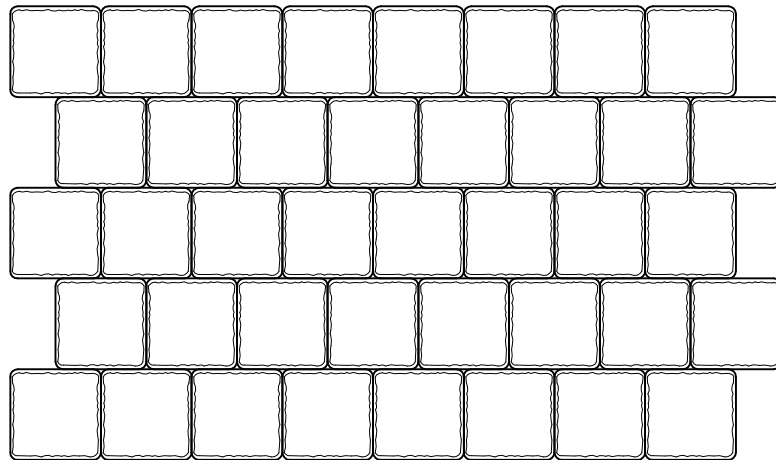
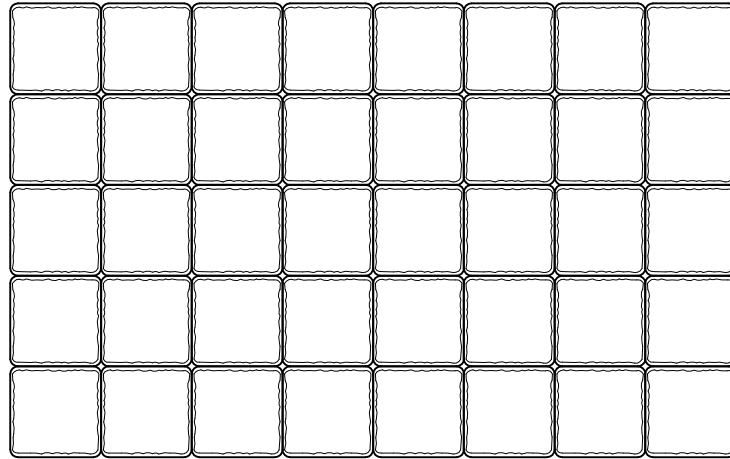

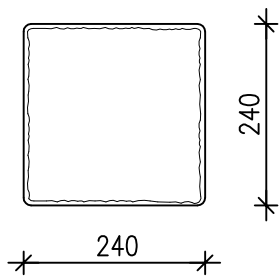

Menekki 17,7kpl/m<sup>2</sup>

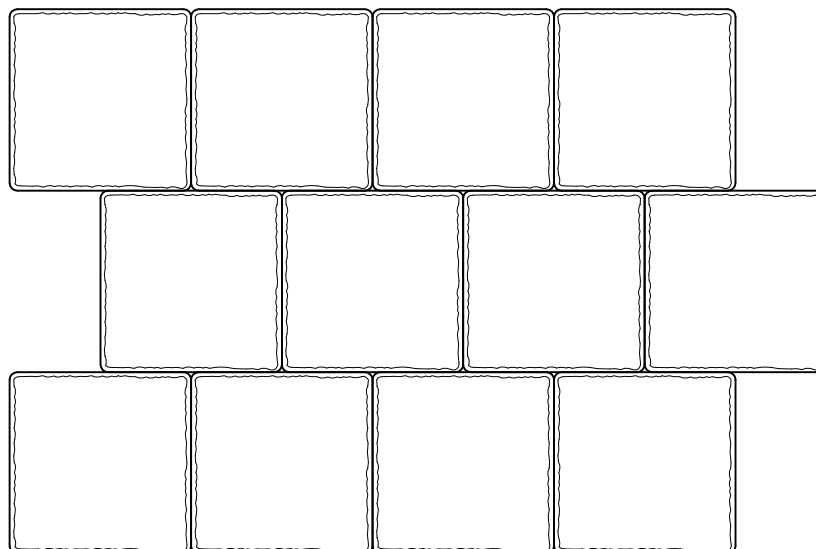
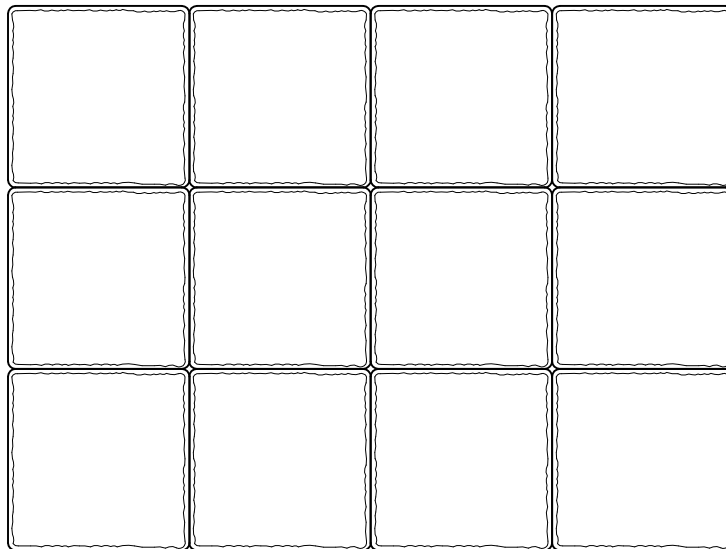

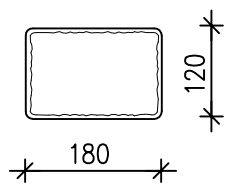
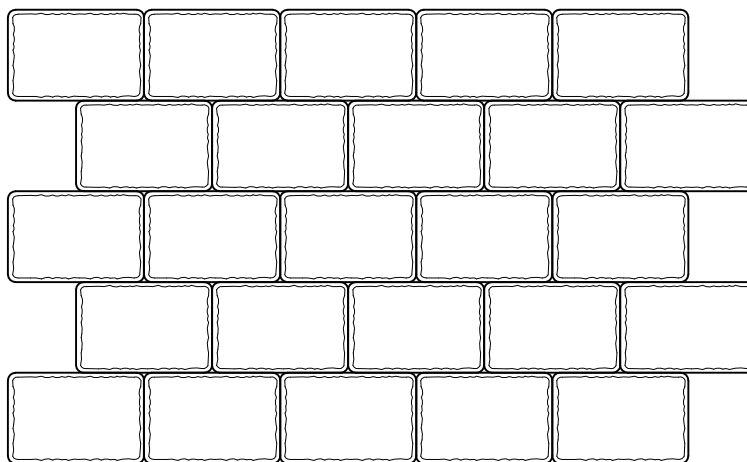
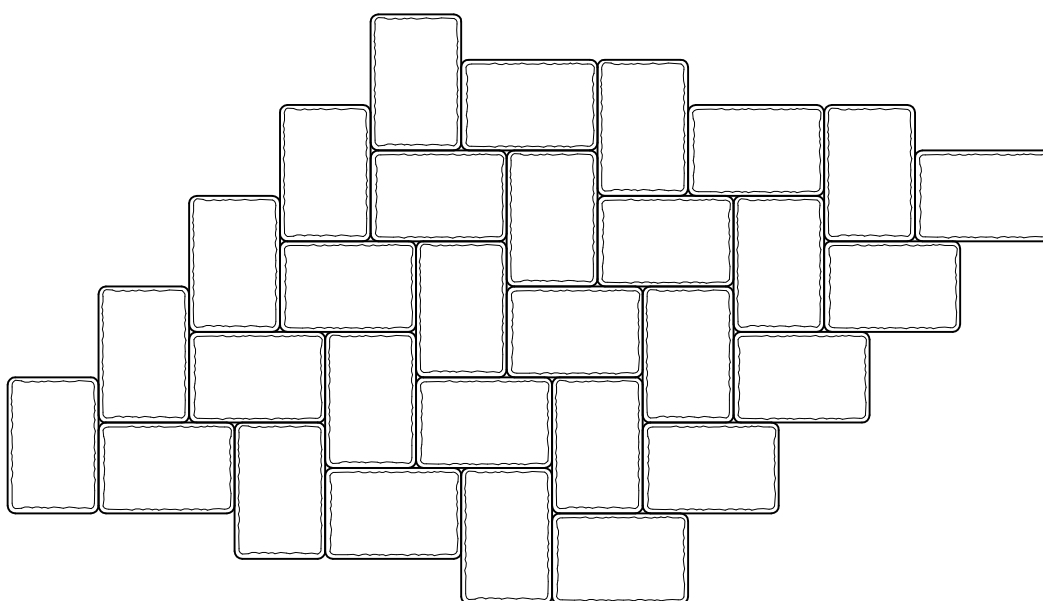

Menekki 47kpl/m<sup>2</sup>



LADONTAMALLIT

LAKAN BETONI OY

1:10

LADONTAESIMERKKEJÄ

24.5.2016

ANTIKKIKIVI PUOLIKAS 60/ ANTIKKIKIVI PUOLIKAS 80

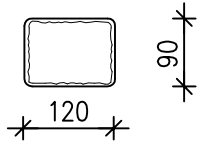

Menekki 94kpl/m<sup>2</sup>

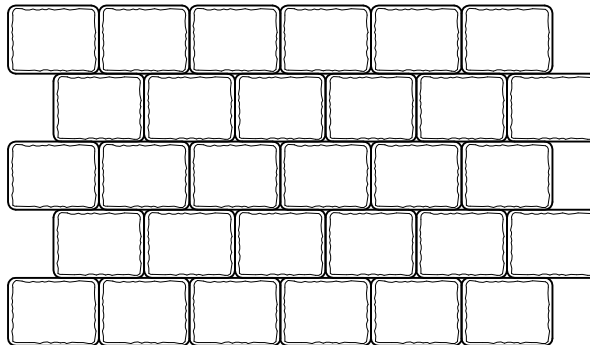
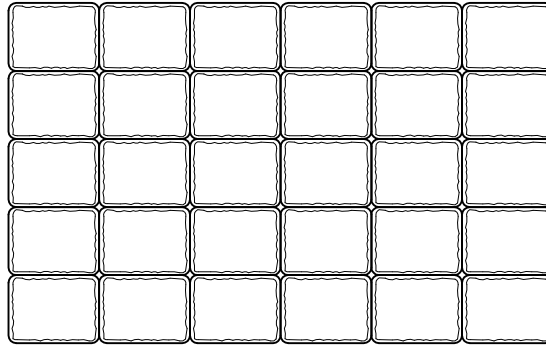

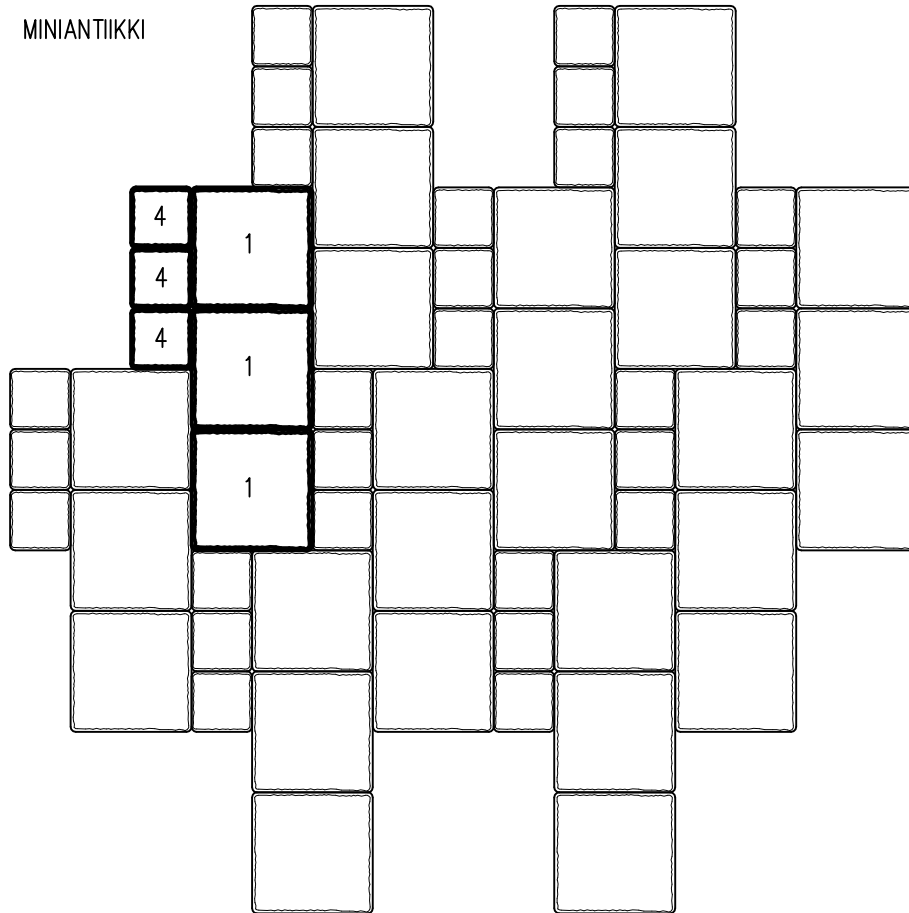
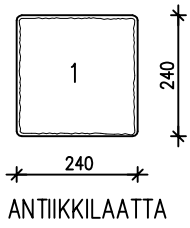

ANTIKKILAATTA 13,88 kpl/m<sup>2</sup> (80% pinta-alasta)  
MINIANTIIKKI 13,88 kpl/m<sup>2</sup> (20% pinta-alasta)

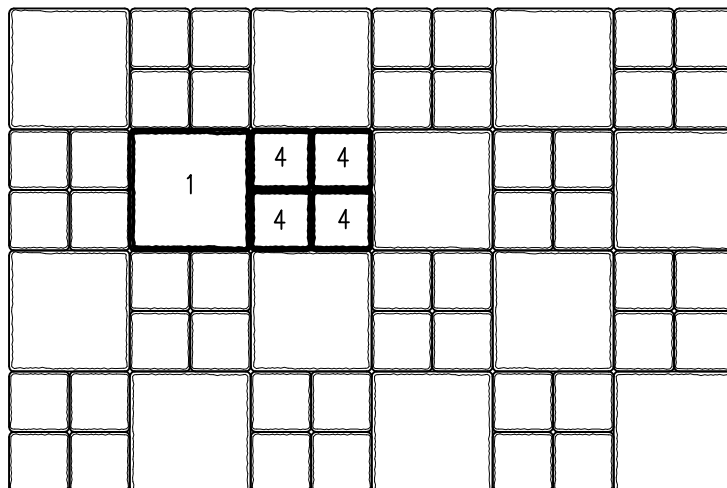

ANTIKKILAATTA 8,68kpl/m<sup>2</sup> (50% pinta-alasta)  
MINIANTIIKKI 34,72 kpl/m<sup>2</sup> (50% pinta-alasta)

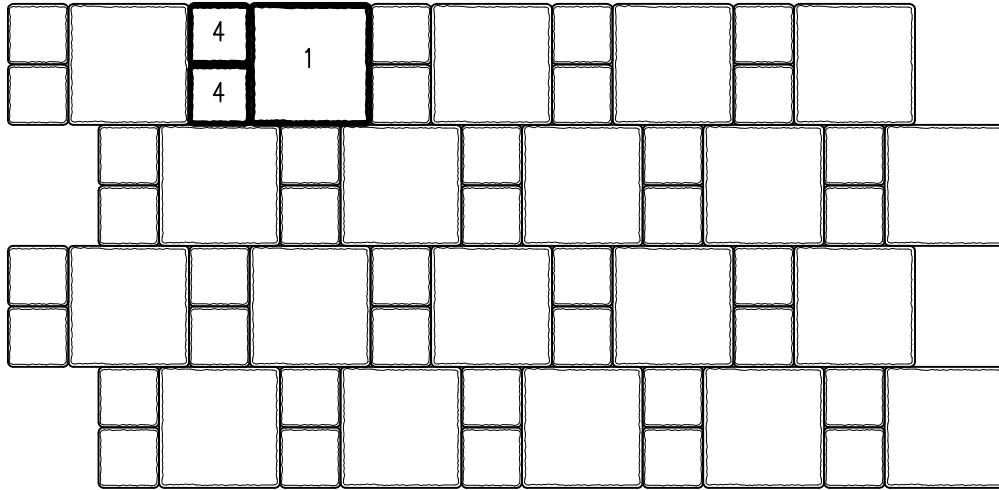
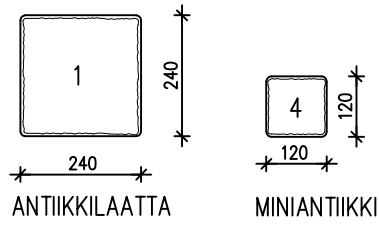

ANTIKKILAATTA 11,58 kpl/m<sup>2</sup> (66,7% pinta-alasta)  
MINIANTIIKKI 23,13 kpl/m<sup>2</sup> (33,3% pinta-alasta)

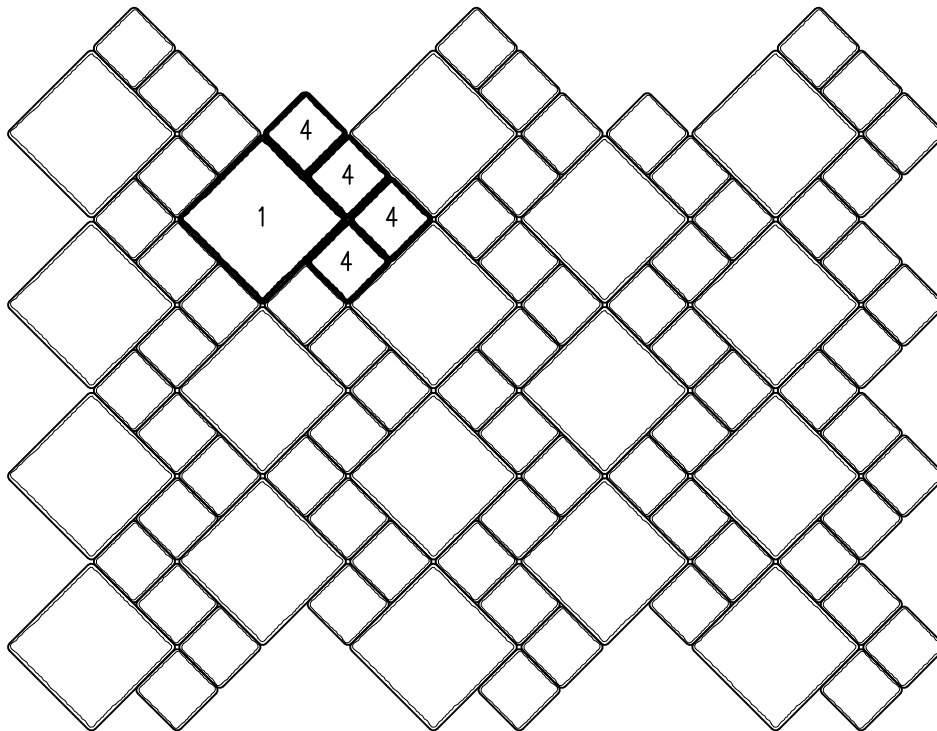

ANTIKKILAATTA 8,68 kpl/m<sup>2</sup> (50% pinta-alasta)  
MINIANTIIKKI 34,72 kpl/m<sup>2</sup> (50% pinta-alasta)

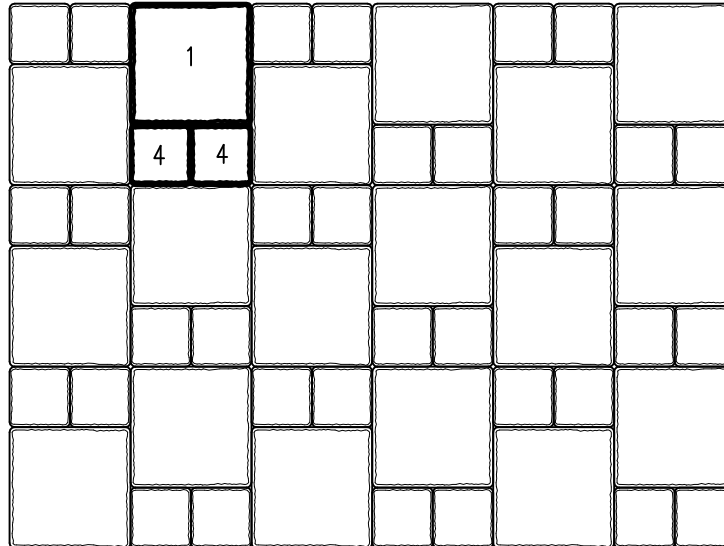
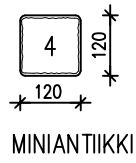
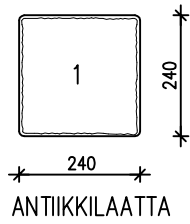

ANTIKKILAATTA 11,58 kpl/m<sup>2</sup> (66,7% pinta-alasta)  
 MINIANTIIKKI 23,13 kpl/m<sup>2</sup> (33,3% pinta-alasta)

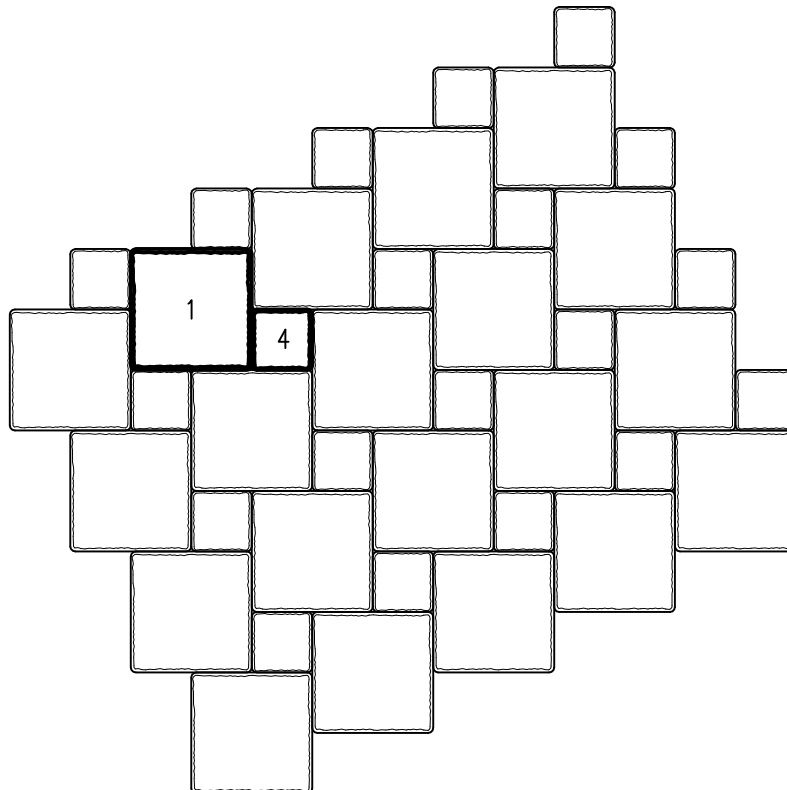

ANTIKKILAATTA 13,88 kpl/m<sup>2</sup> (80% pinta-alasta)  
 MINIANTIIKKI 13,88 kpl/m<sup>2</sup> (20% pinta-alasta)

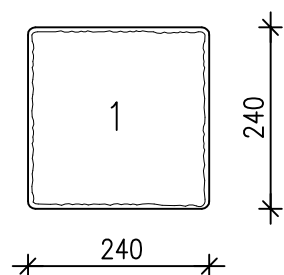

ANTIKKILAATTA

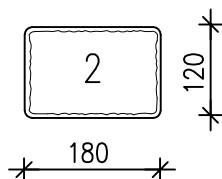

ANTIKKIKIVI

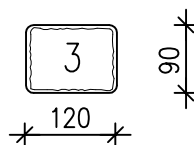

ANTIKKIKIVI PUOLIKAS

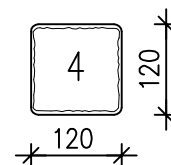

MINIANTIIKKI

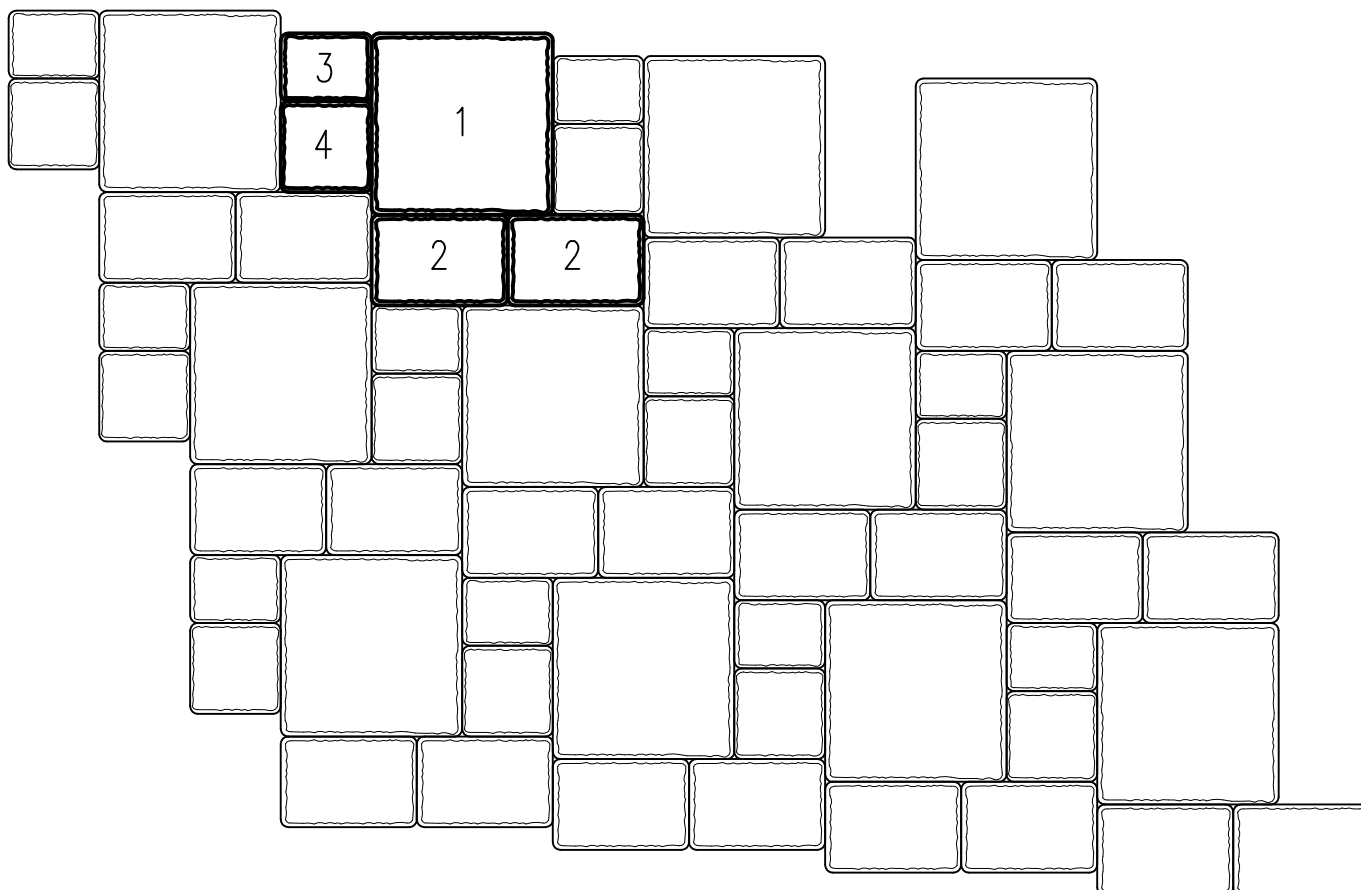

ANTIKKILAATTA 7,95 kpl/m<sup>2</sup> (45,7% pinta-alasta)

ANTIKKIKIVI 15,77 kpl/m<sup>2</sup> (34,3% pinta-alasta)

ANTIKKIKIVI PUOLIKAS 8 kpl/m<sup>2</sup> (8,6% pinta-alasta)

MINIANTIIKKI 8 kpl/m<sup>2</sup> (11,4% pinta-alasta)

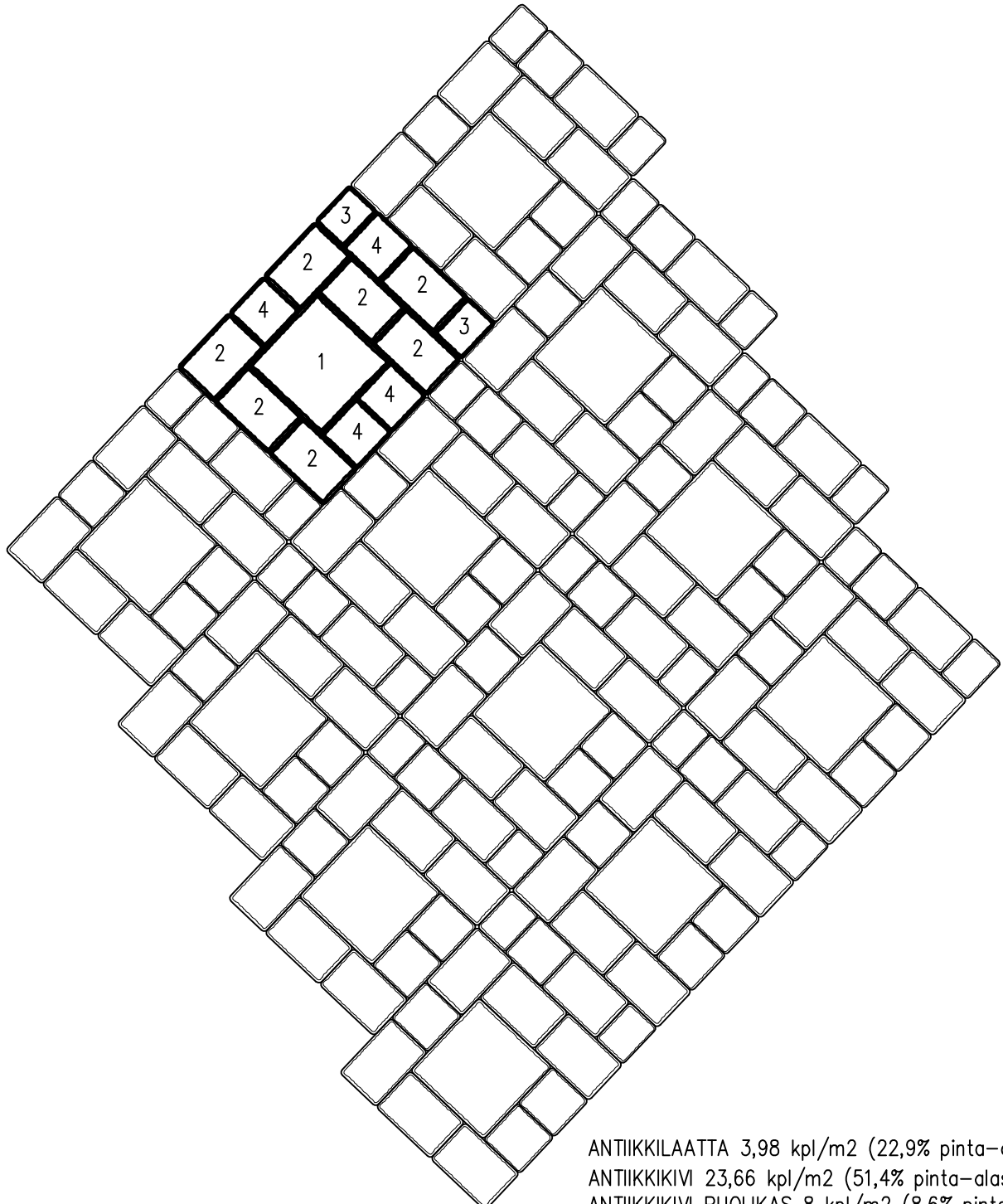
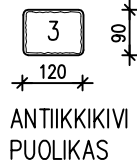
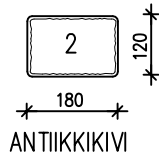
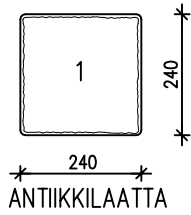

ANTIKKILAATTA 3,98 kpl/m<sup>2</sup> (22,9% pinta-alasta)  
 ANTIKKIKIVI 23,66 kpl/m<sup>2</sup> (51,4% pinta-alasta)  
 ANTIKKIKIVI PUOLIKAS 8 kpl/m<sup>2</sup> (8,6% pinta-alasta)  
 MINIANTIIKKI 12 kpl/m<sup>2</sup> (17,1% pinta-alasta)

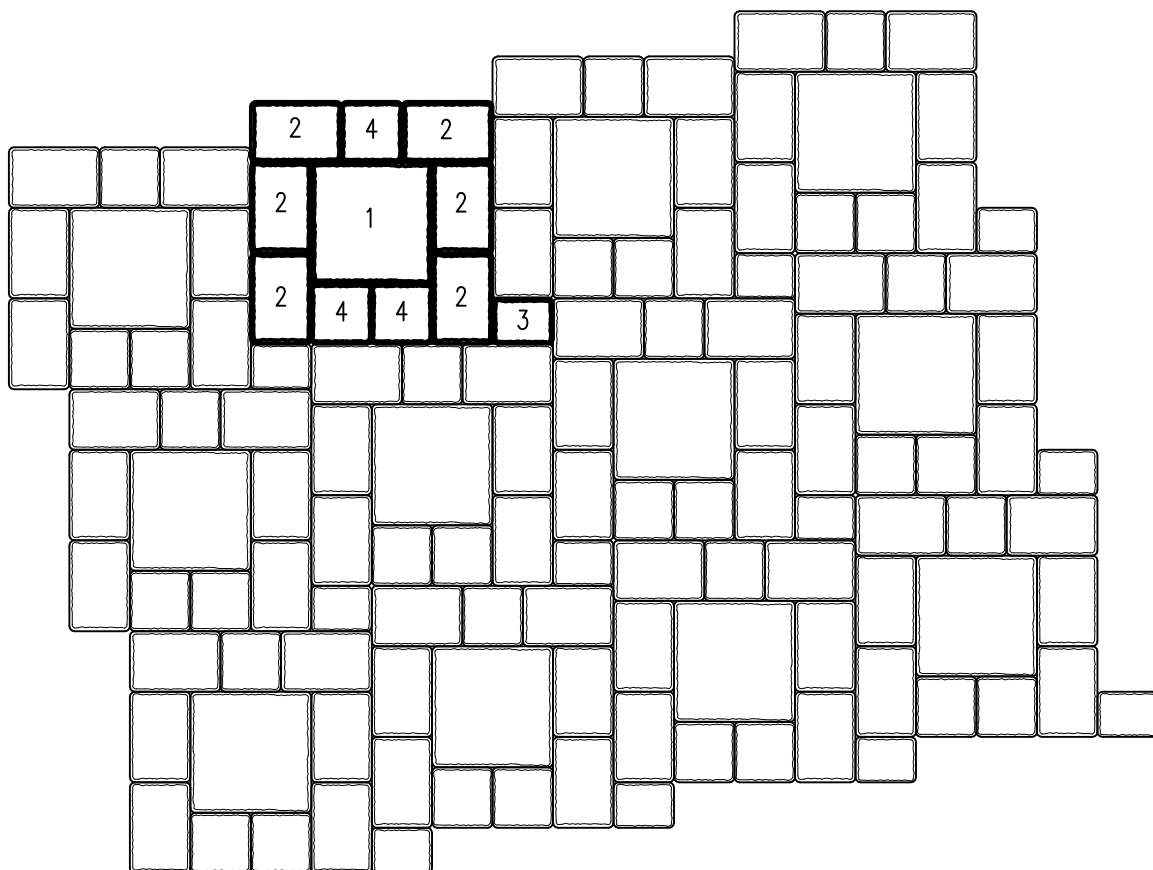
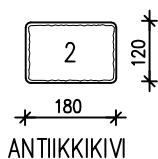
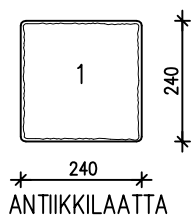

ANTIKKILAATTA 4,14 kpl/m<sup>2</sup> (23,8% pinta-alasta)  
 ANTIKKIKIVI 24,87 kpl/m<sup>2</sup> (54% pinta-alasta)  
 ANTIKKIKIVI PUOLIKAS 4,16 kpl/m<sup>2</sup> (4,4% pinta-alasta)  
 MINIANTIKKI 12,43 kpl/m<sup>2</sup> (17,8% pinta-alasta)



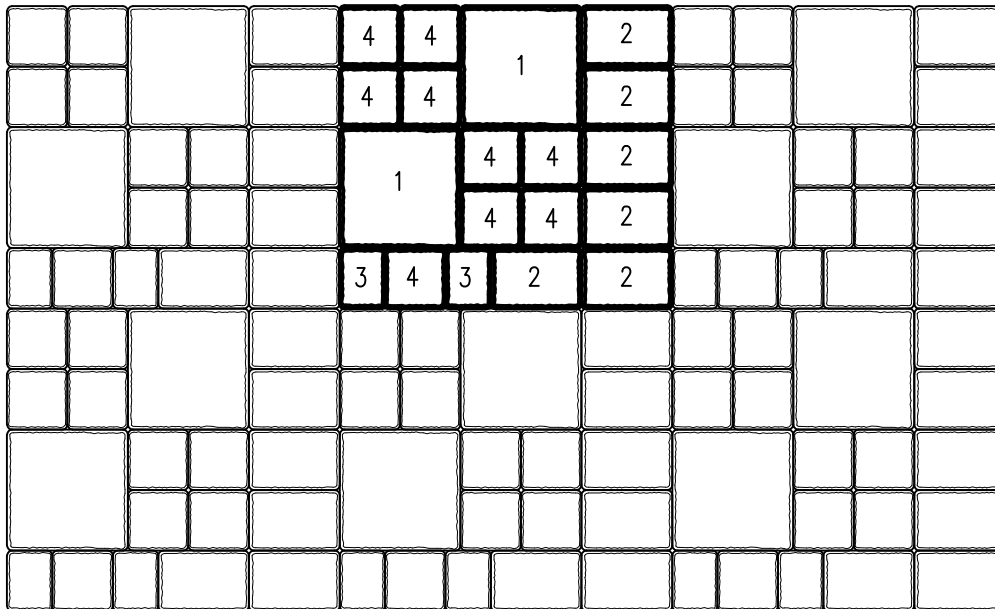
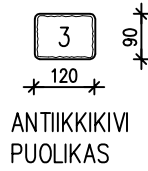
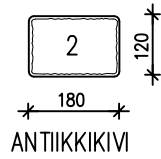
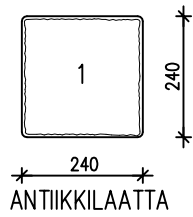

ANTIICKILAATTA 5,05 kpl/m<sup>2</sup> (29% pinta-alasta)  
 ANTIICKIKIVI 15,2 kpl/m<sup>2</sup> (33% pinta-alasta)  
 ANTIICKIKIVI PUOLIKAS 5 kpl/m<sup>2</sup> (5,5% pinta-alasta)  
 MINIANTIICKI 22,73 kpl/m<sup>2</sup> (32,5% pinta-alasta)

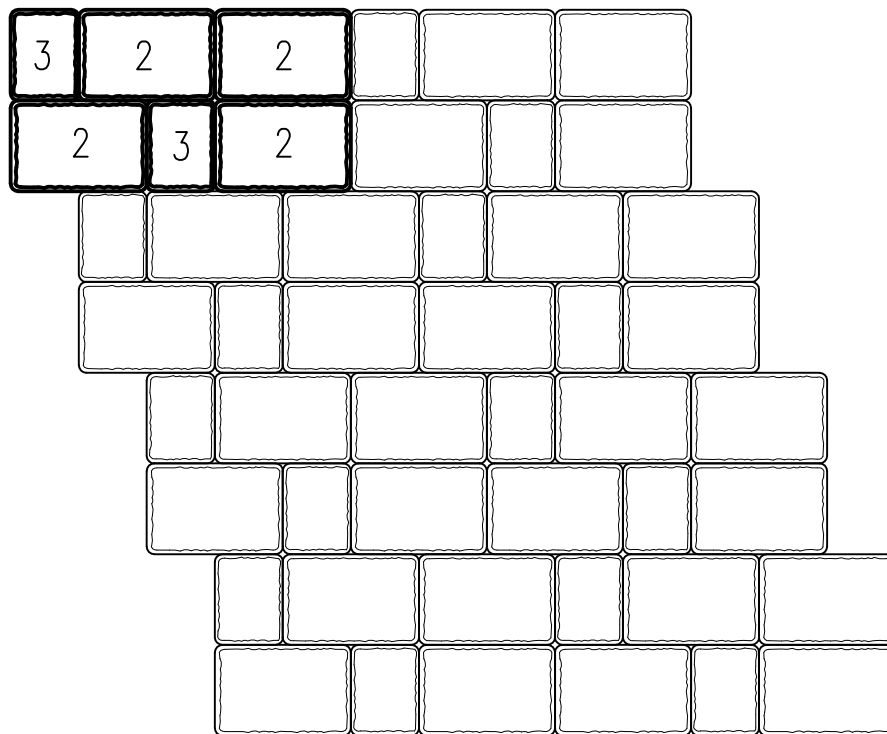
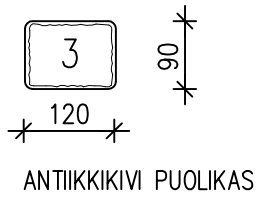
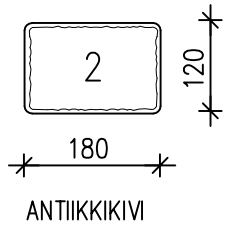

ANTIKKIKIVI 38 kpl/m<sup>2</sup> (80% pinta-alasta)

ANTIKKIKIVI PUOLIKAS 19 kpl/m<sup>2</sup> (20% pinta-alasta)

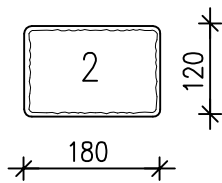

ANTIKKIKIVI

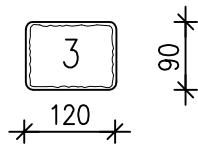

ANTIKKIKIVI PUOLIKAS

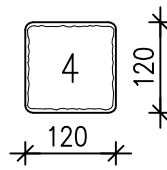

MINIANTIKKI

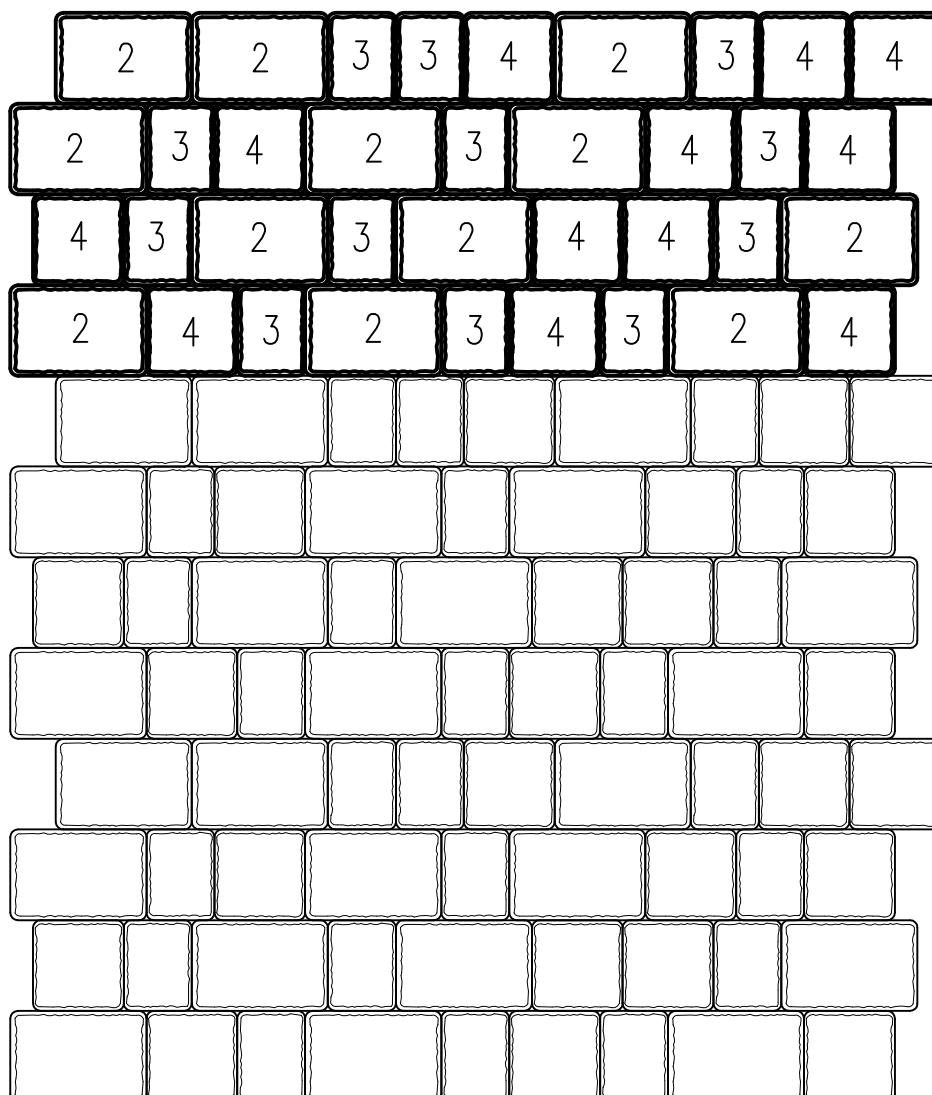

ANTIKKIKIVI 21,6 kpl/m<sup>2</sup> (46% pinta-alasta)

ANTIKKIKIVI PUOLIKAS 21,6 kpl/m<sup>2</sup> (23% pinta-alasta)

MINIANTIKKI 22 kpl/m<sup>2</sup> (31% pinta-alasta)

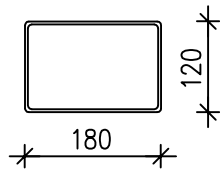

Menekki 47kpl/m<sup>2</sup>  
(Huom. reunaviisteetön)

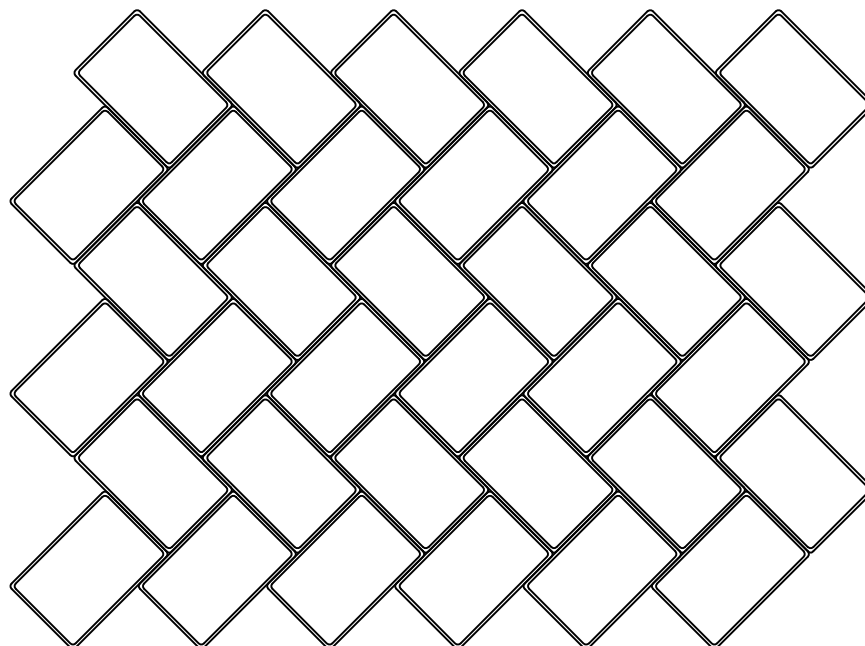
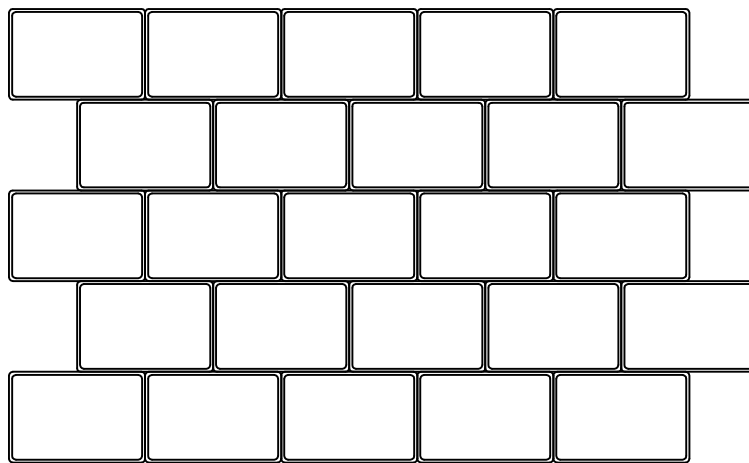

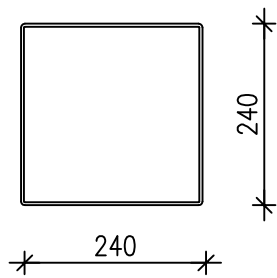

Menekki 17,7kpl/m<sup>2</sup>

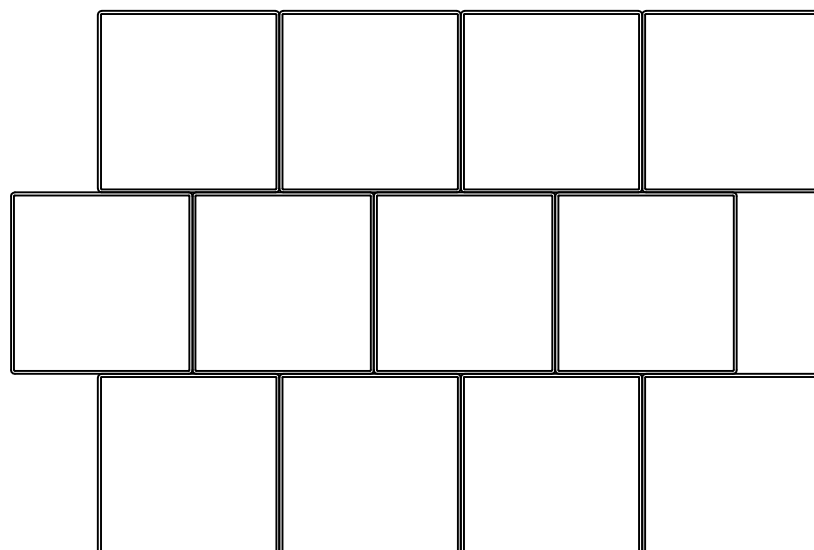
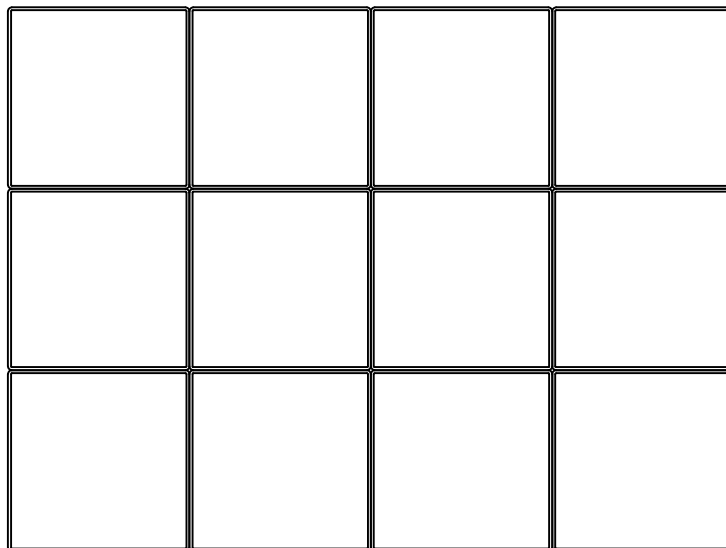

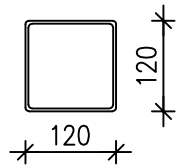

Menekki 71kpl/m<sup>2</sup>

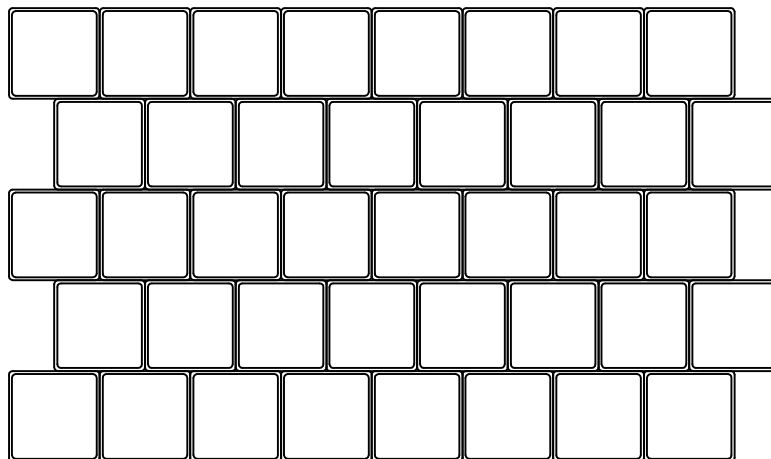
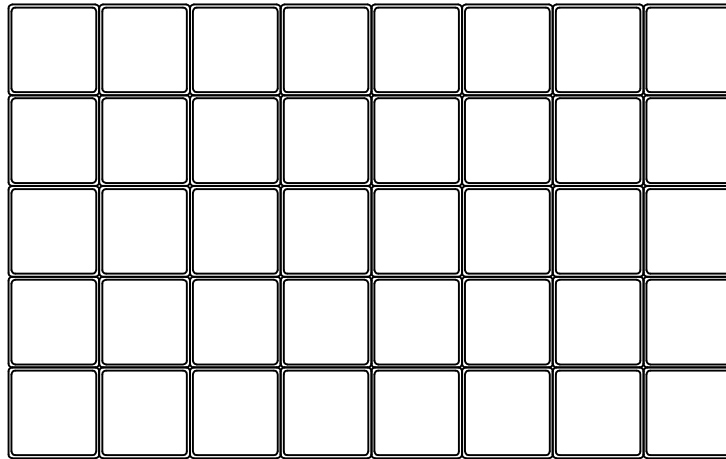

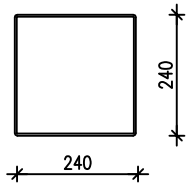

CITYLAATTA

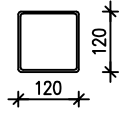

MINICITY

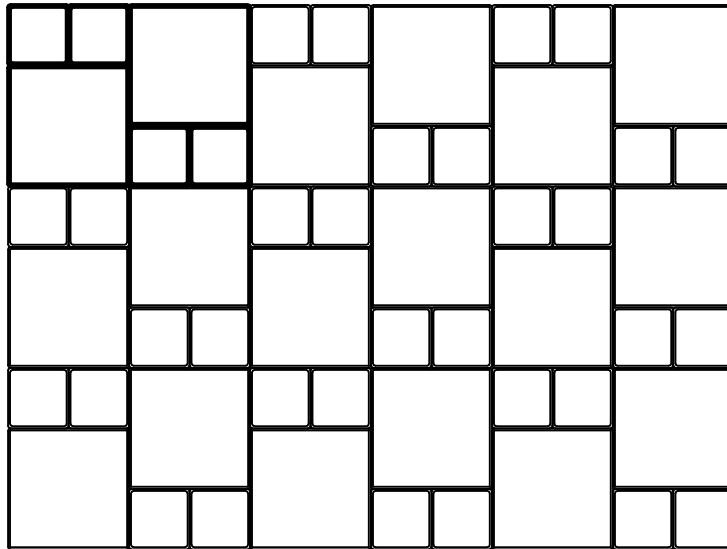

CITYLAATTA 11,58 kpl/m<sup>2</sup> (66,7% pinta-alasta)

MINICITY 23,13 kpl/m<sup>2</sup> (33,3% pinta-alasta)

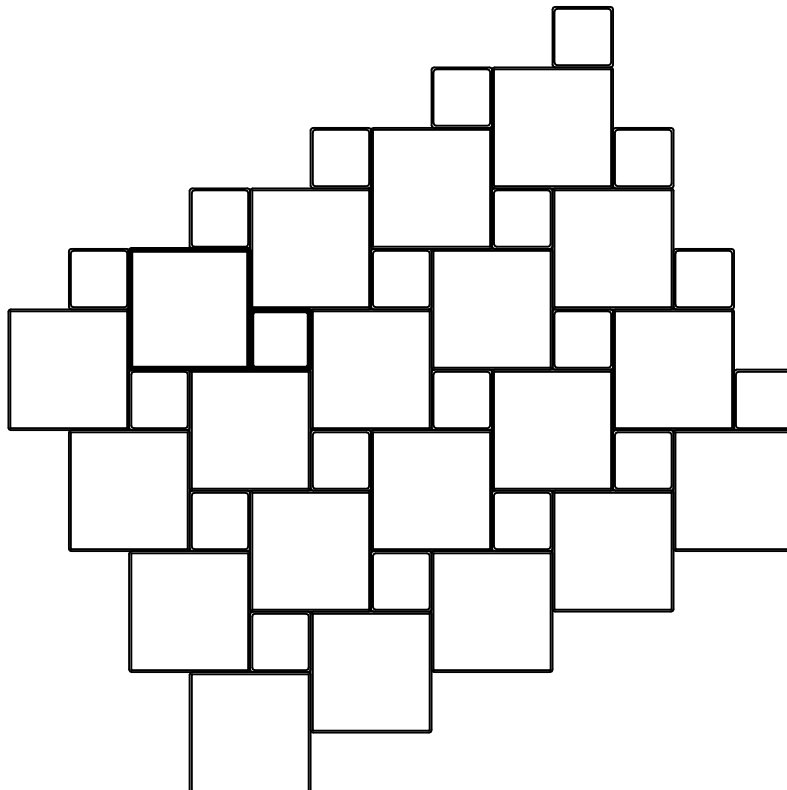

CITYLAATTA 13,88 kpl/m<sup>2</sup> (80% pinta-alasta)

MINICITY 13,88 kpl/m<sup>2</sup> (20% pinta-alasta)

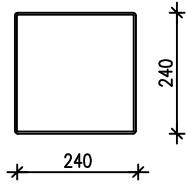

CITYLAATTA

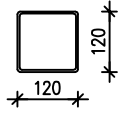

MINICITY

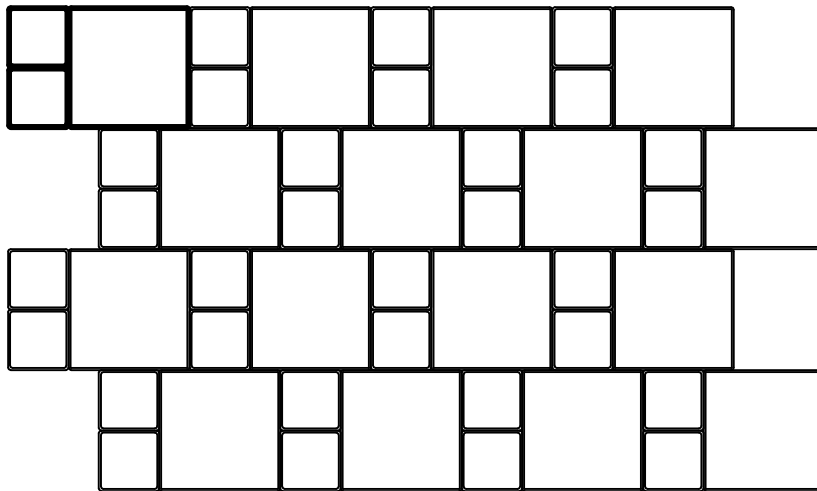

CITYLAATTA 11,58 kpl/m<sup>2</sup> (66,7% pinta-alasta)

MINICITY 23,13 kpl/m<sup>2</sup> (33,3% pinta-alasta)

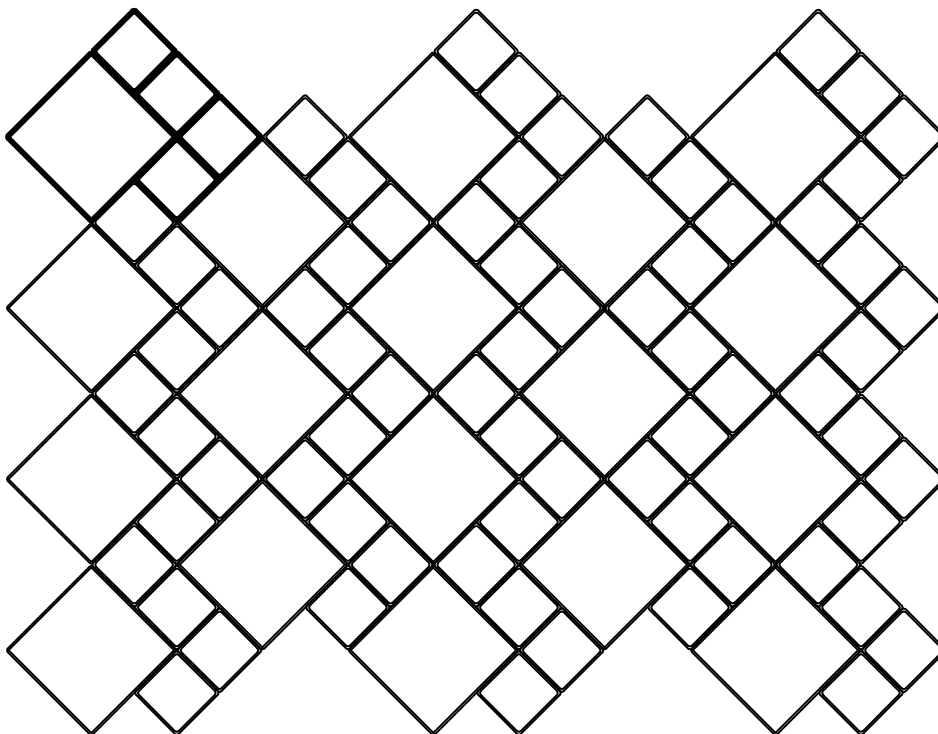

CITYLAATTA 8,68 kpl/m<sup>2</sup> (50% pinta-alasta)

MINICITY 34,72 kpl/m<sup>2</sup> (50% pinta-alasta)



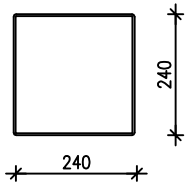

CITYLAATTA

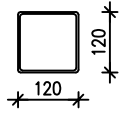

MINICITY

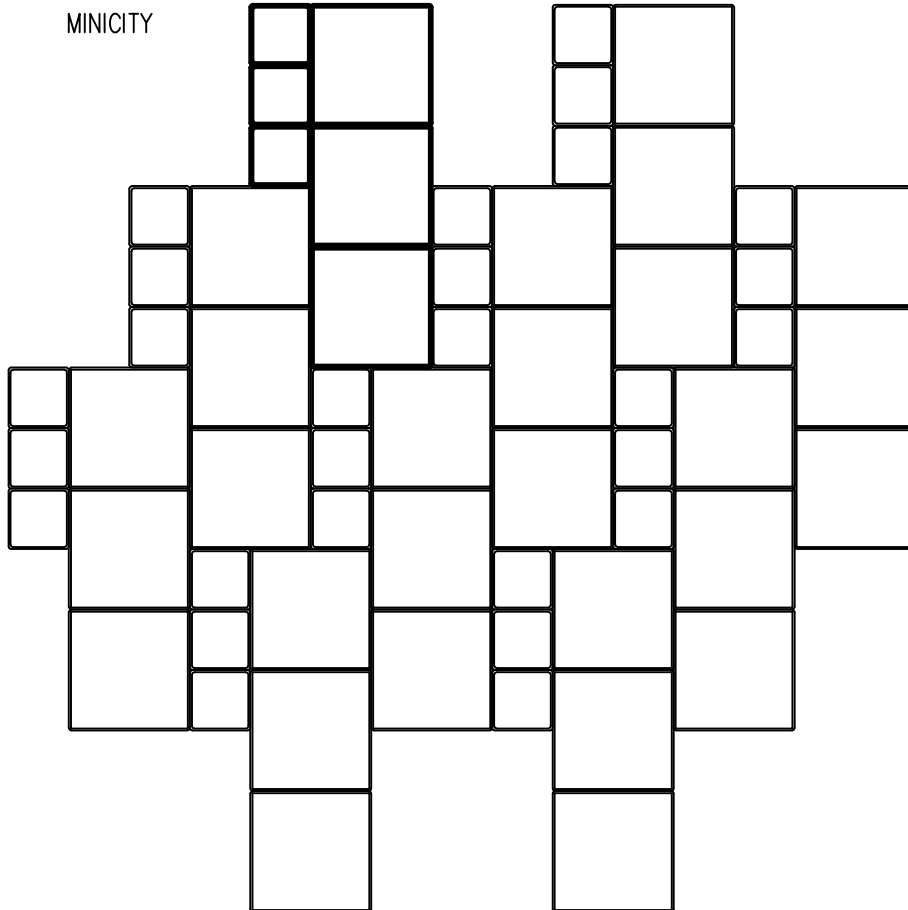

CITYLAATTA 13,88 kpl/m<sup>2</sup> (80% pinta-alasta)

MINICITY 13,88 kpl/m<sup>2</sup> (20% pinta-alasta)

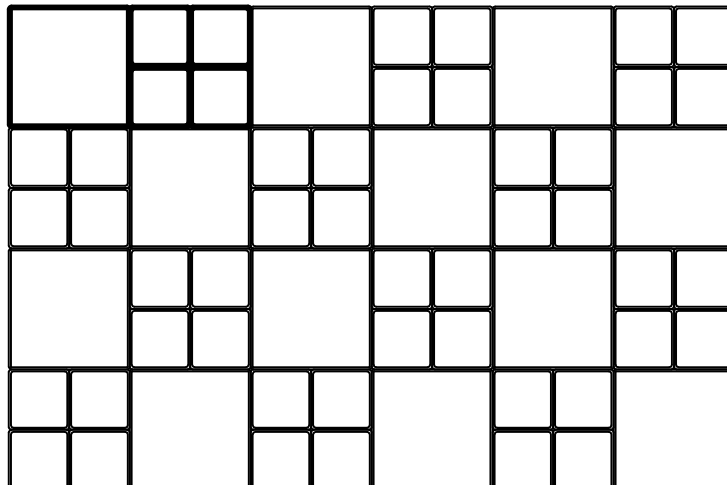

CITYLAATTA 8,68kpl/m<sup>2</sup> (50% pinta-alasta)

MINICITY 34,72 kpl/m<sup>2</sup> (50% pinta-alasta)



LADONTAMALLIT

LAKAN BETONI OY

1:10

LADONTAESIMERKKEJÄ

24.5.2016

H-KIVI 80

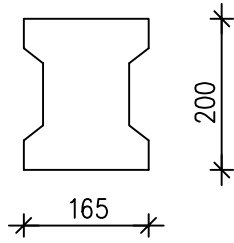

Menekki 36kpl/m<sup>2</sup>

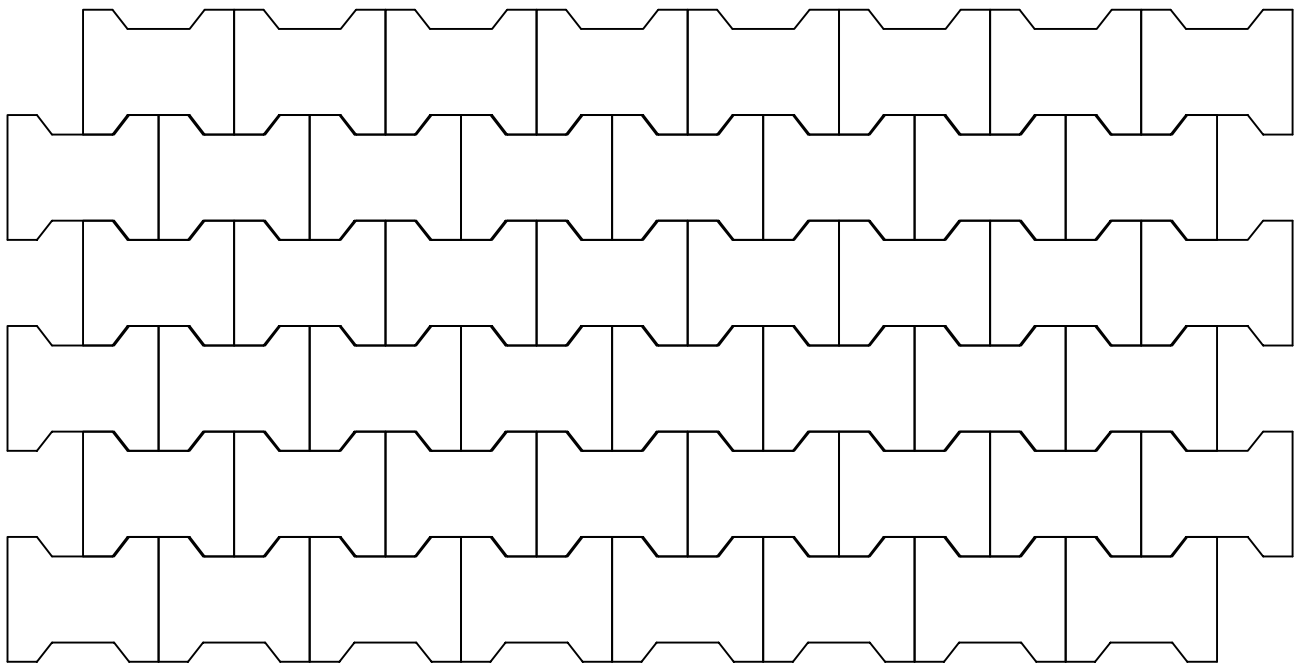

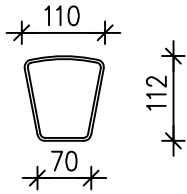

Menekki 91kpl/m<sup>2</sup>

KLASSIKKO KAARREKIVI

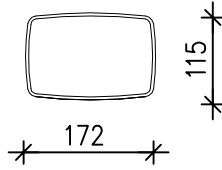

Menekki 50kpl/m<sup>2</sup>

KLASSIKKOKIVI

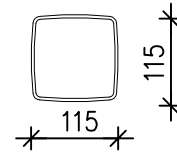

Menekki 76kpl/m<sup>2</sup>

KLASSIKKO NELIÖKIVI

KAIVON YMPÄRYKSET

Ø 300, 14 KPL KLASSIKKO KAARREKIVIÄ

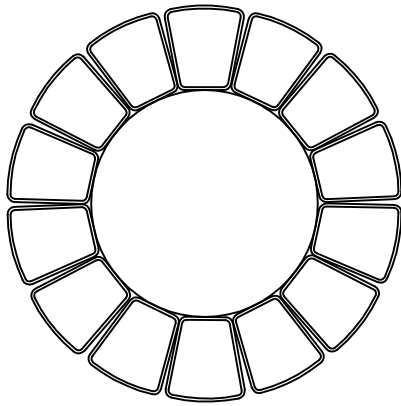

Ø 400, 17 KPL KLASSIKKO KAARREKIVIÄ

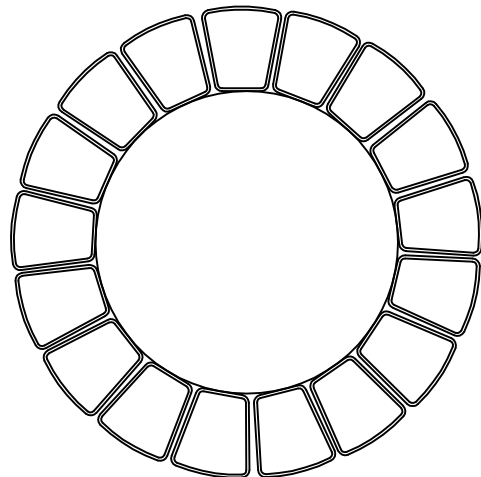

Ø 500, 20 KPL KLASSIKKO KAARREKIVIÄ

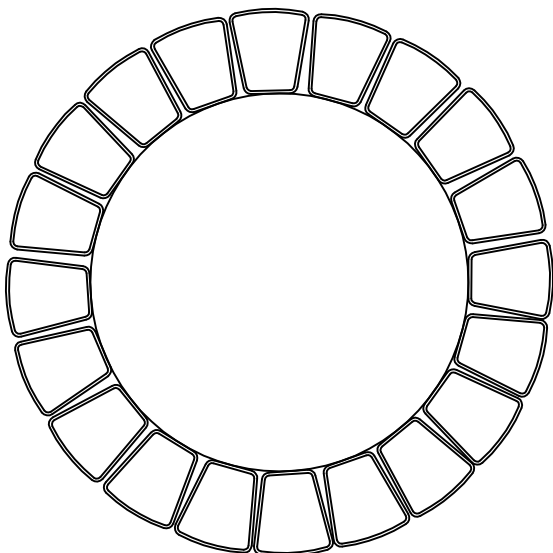

Ø 600, 23 KPL KLASSIKKO KAARREKIVIÄ

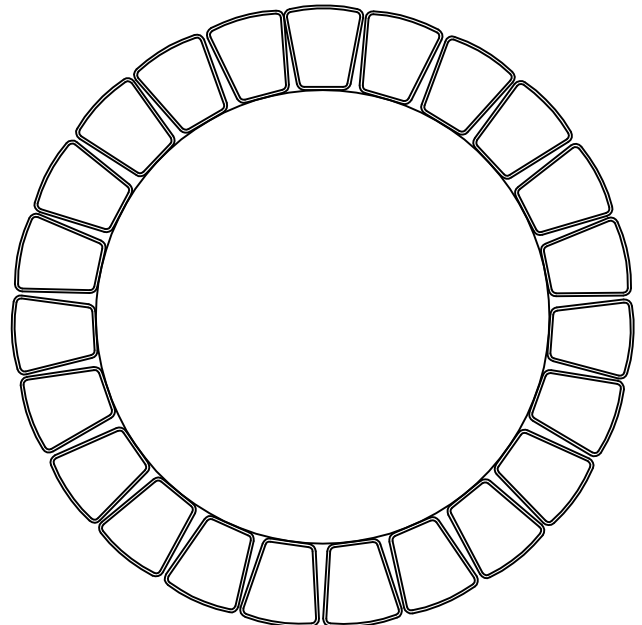

KLASSIKKO KIVISARJAN YMPYRÄLADONNAN KESKUS ALOITETAAN NELJÄLLÄ KLASSIKKO KAARREKIVELLÄ, JOIDEN VÄLIT TÄYTETÄÄN SAUMAHIEKALLA.

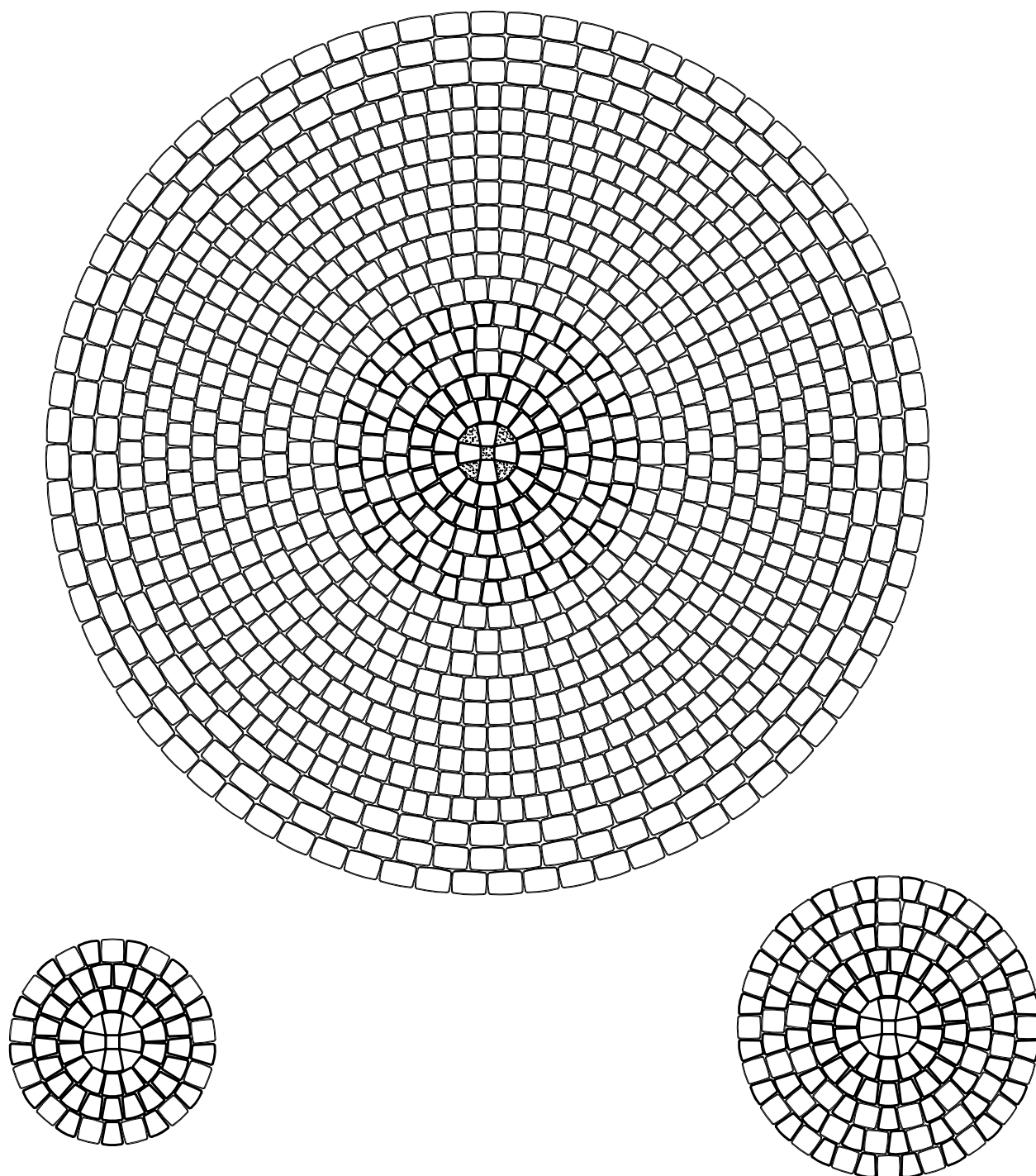

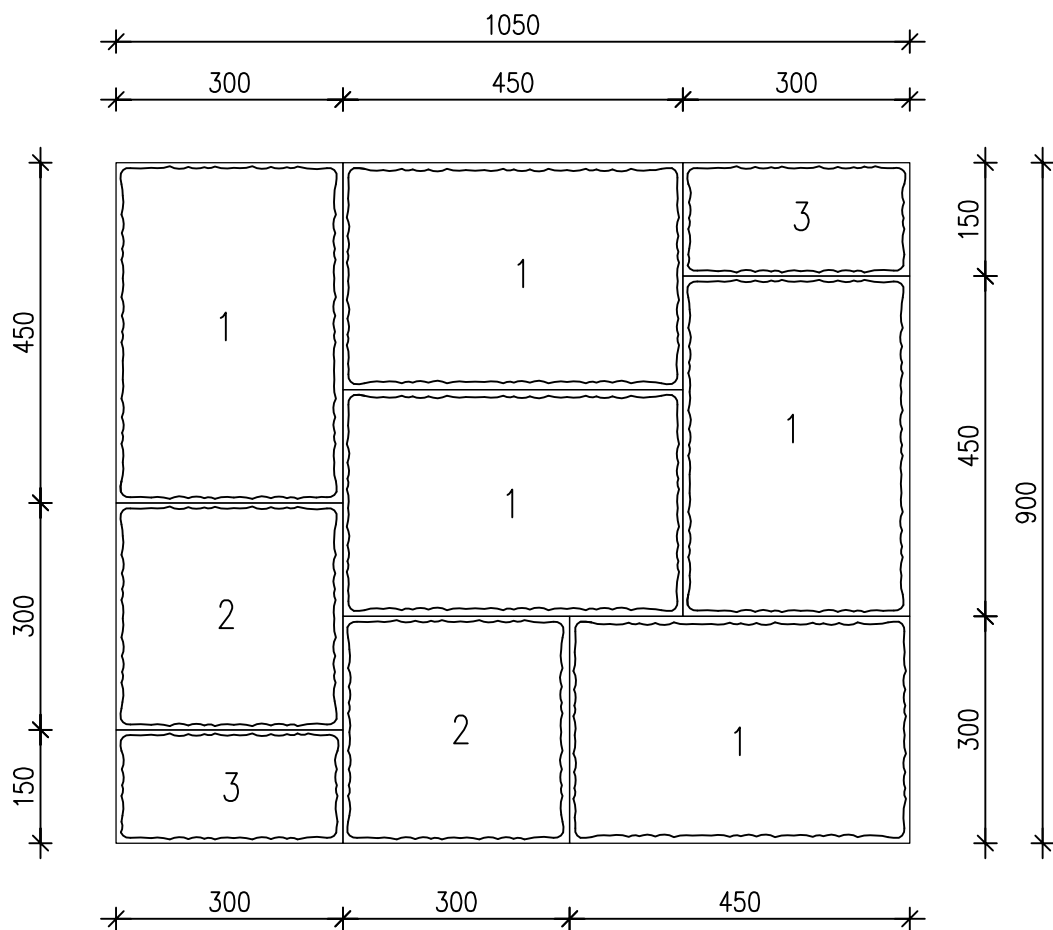
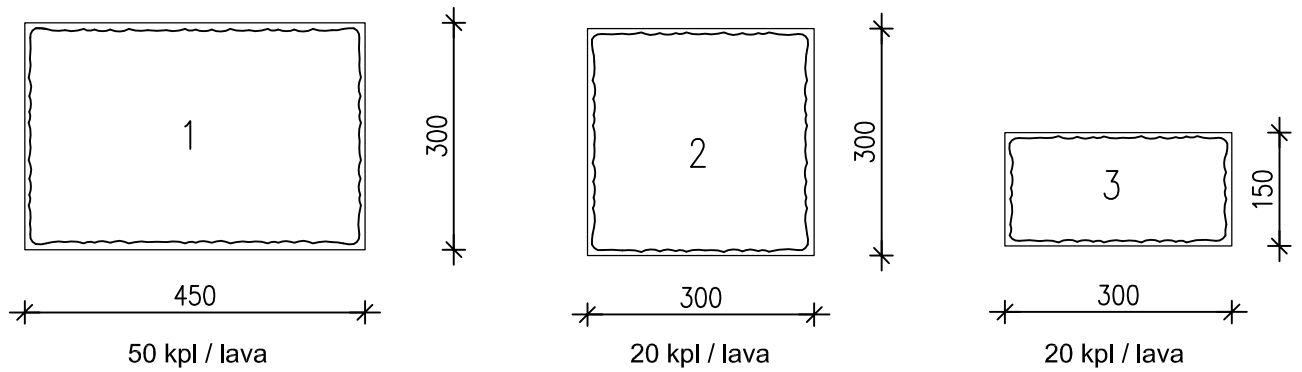

VALMIS LADONTAKUVIO LAVAKERROKSISSA 0,95 m<sup>2</sup>

VALMIS LADONTAKUVIO LAVAKERROKSISSA

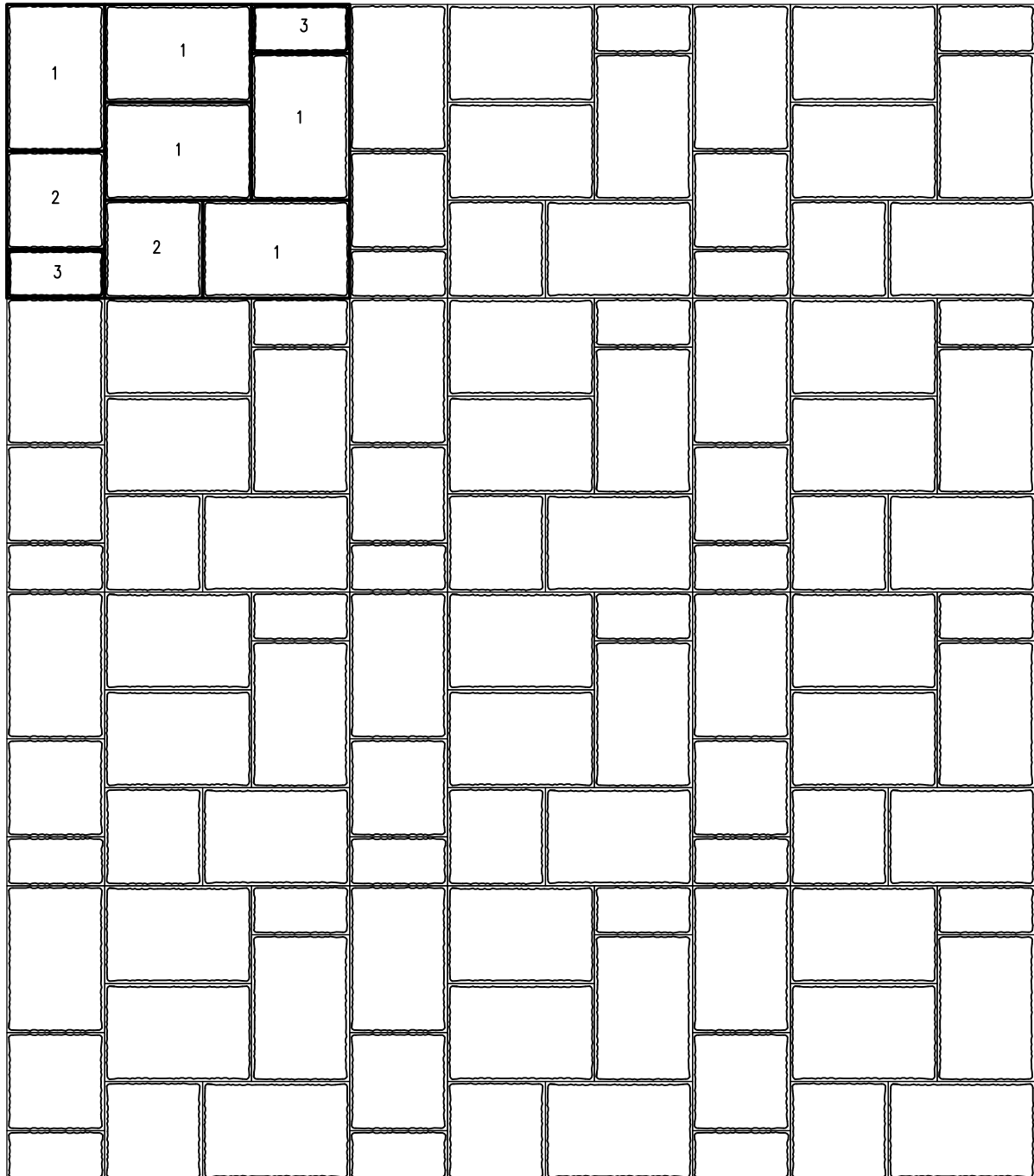

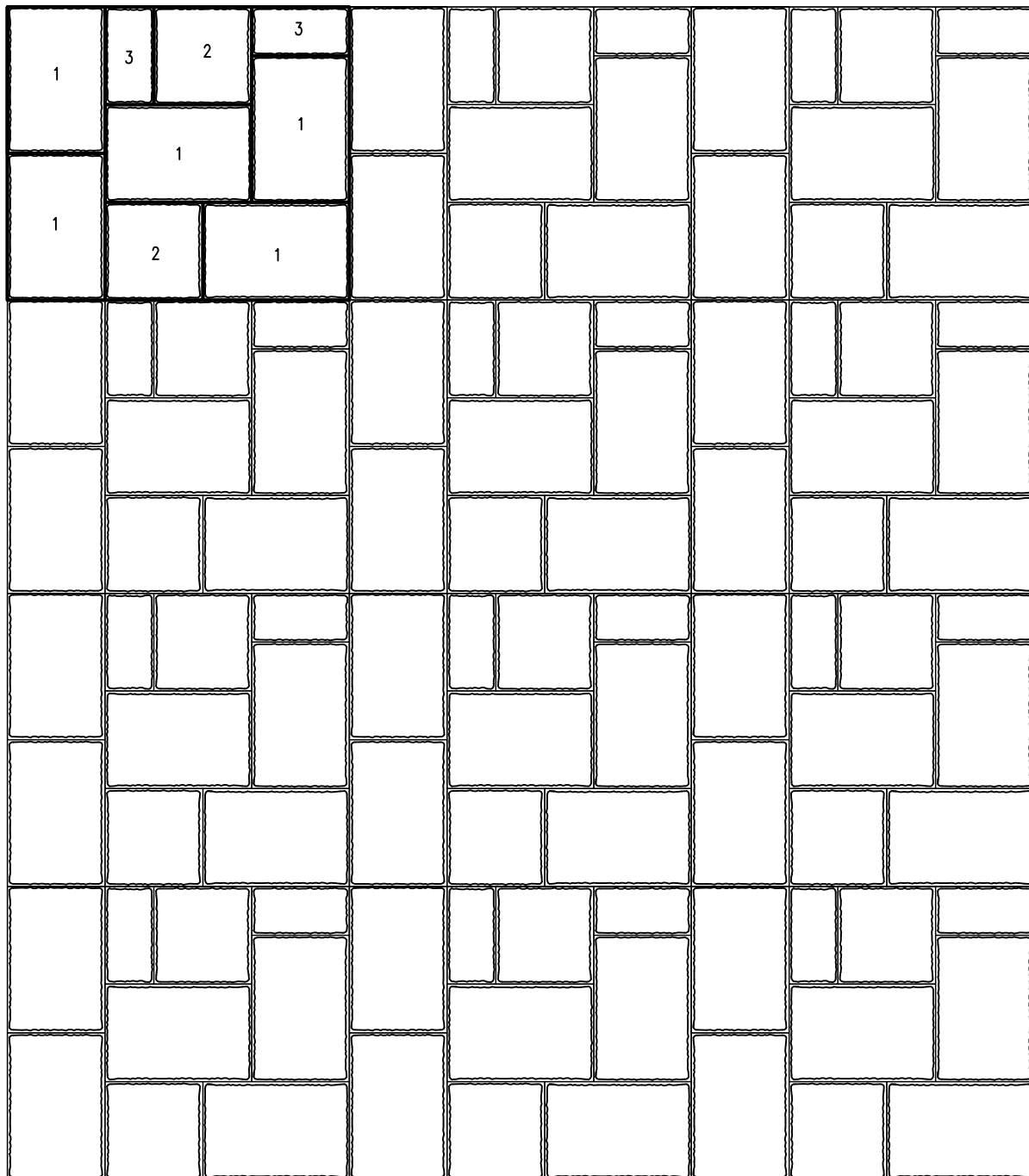

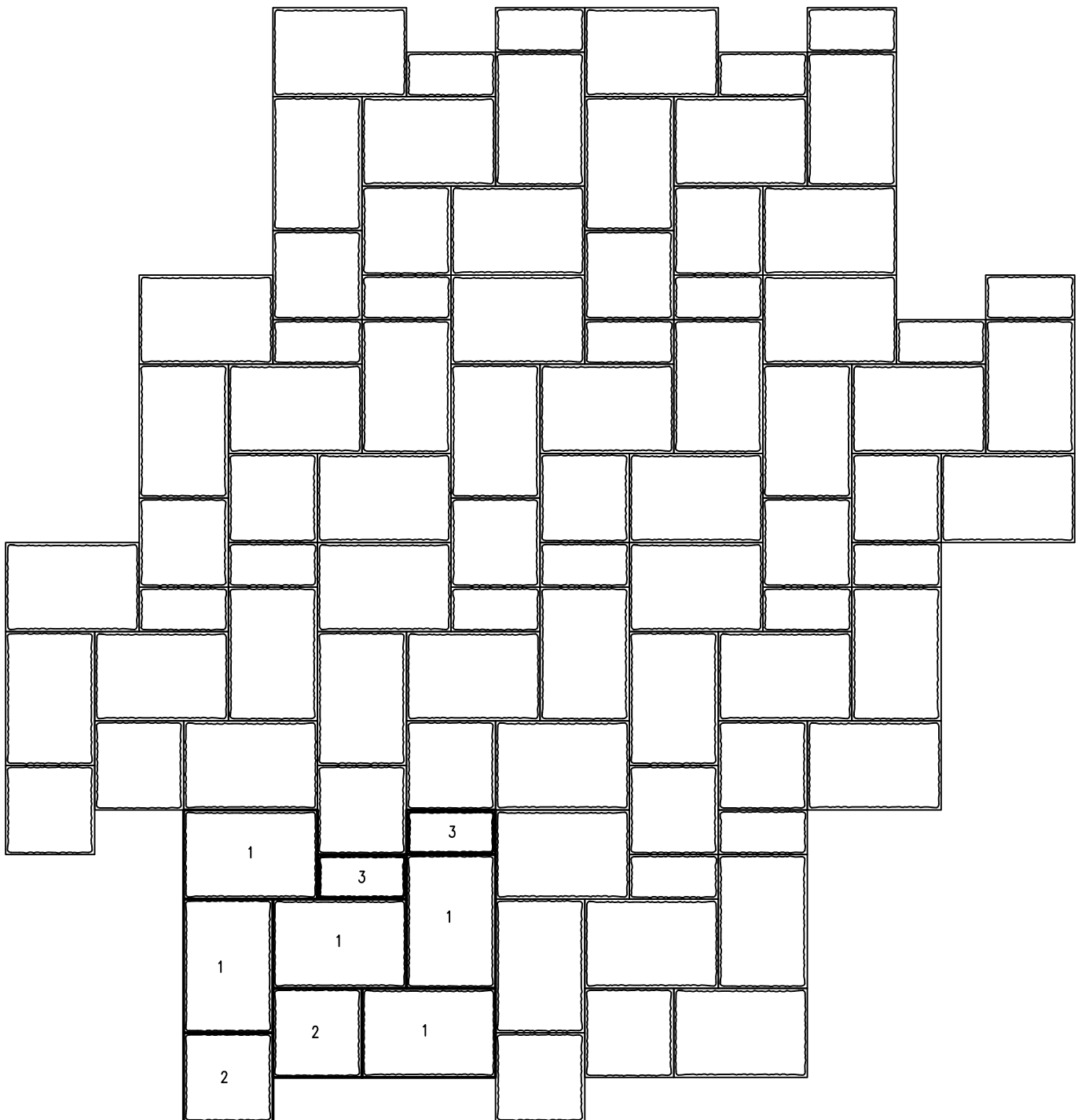



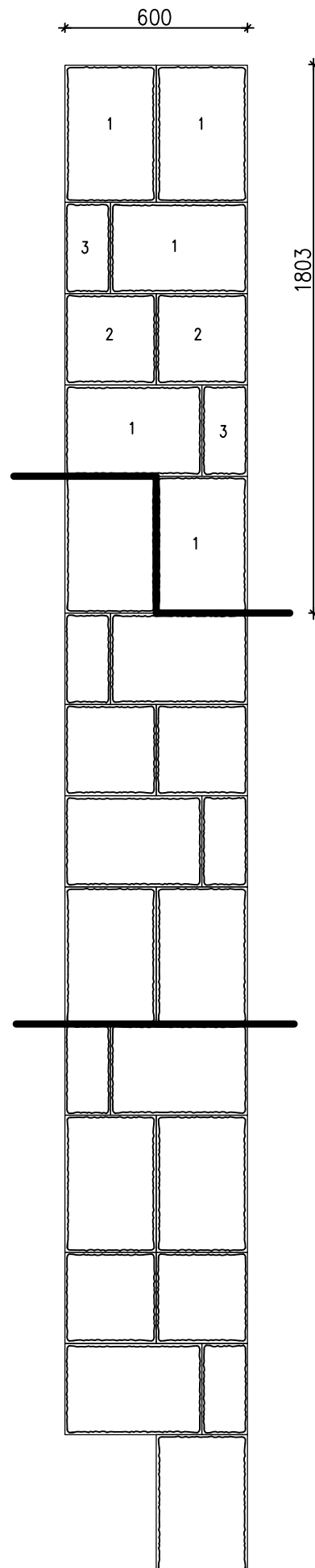
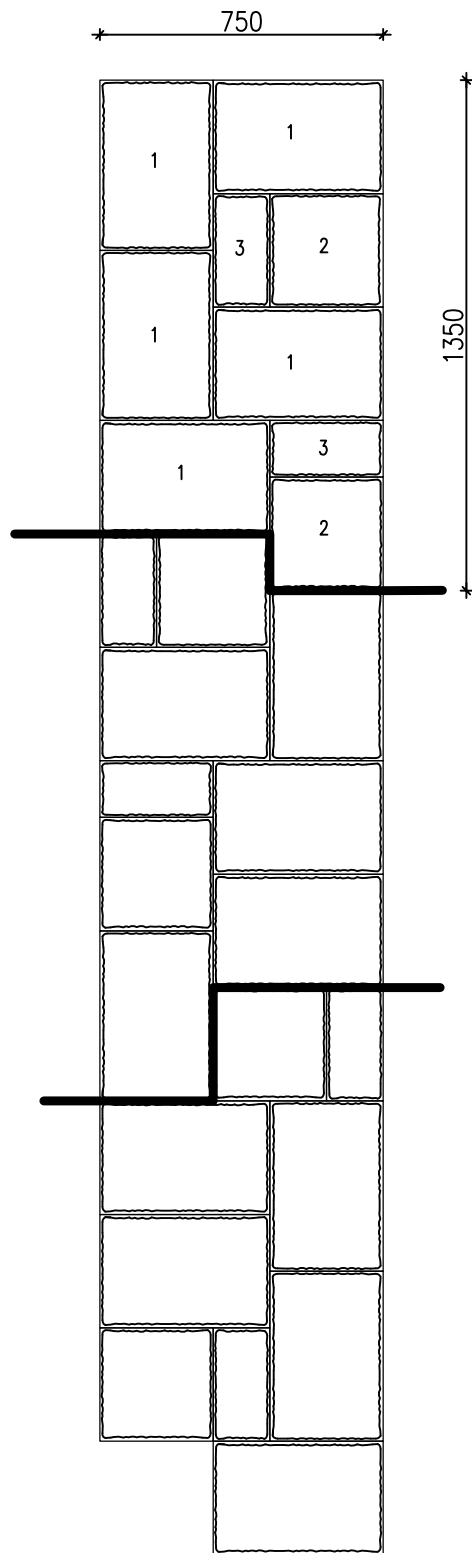

LADONTOIHIN ON MERKATTU TUMMENNETUILLA VIVOILLA  
YHDEN LAVAKERROKSEN KIVET

180



120

Menekki 46kpl/m<sup>2</sup>

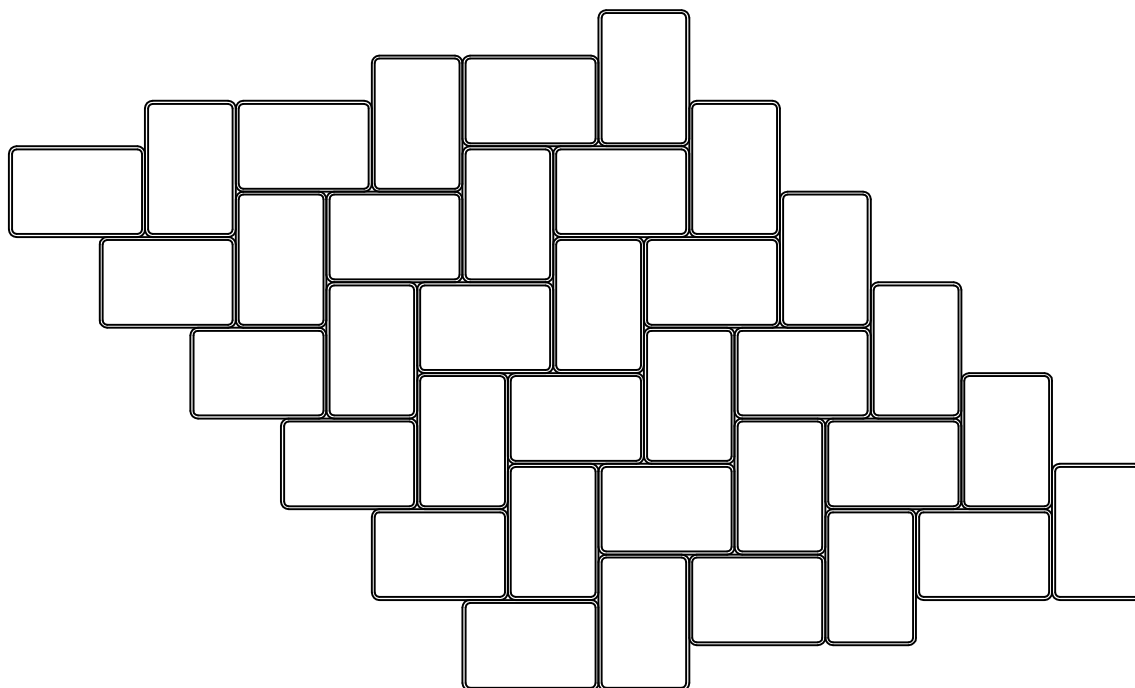
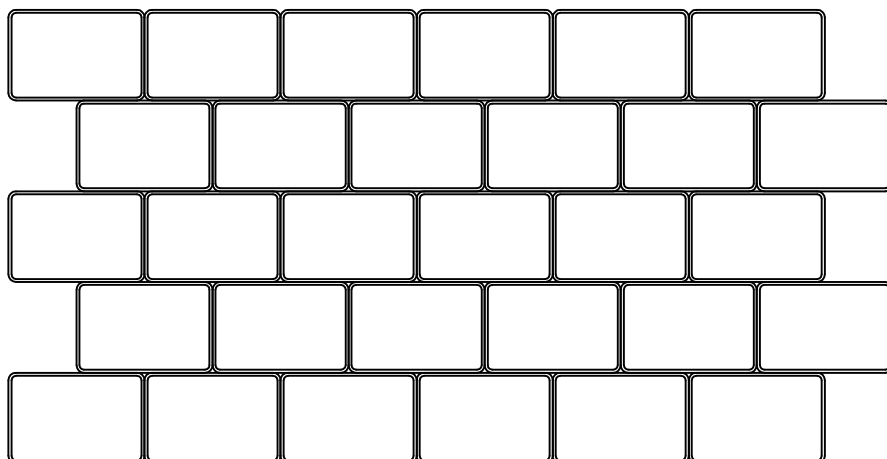

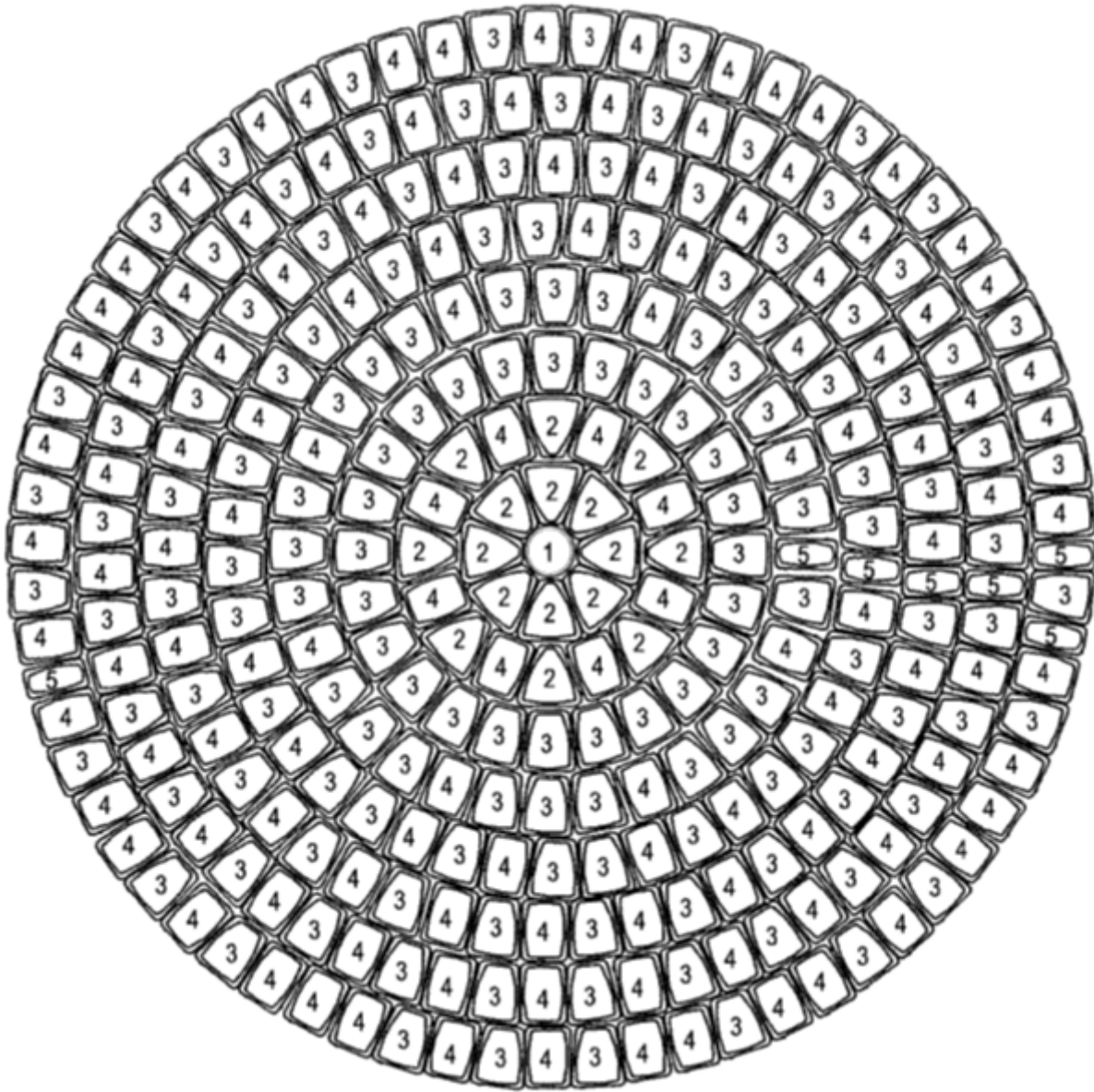

	Kpl					Sarja
	Kivi 1	Kivi 2	Kivi 3	Kivi 4	Kivi 5	
<b>Kehä 0</b>	1					
<b>Kehä 1</b>		8				
<b>Kehä 2</b>		8		8		2-4
<b>Kehä 3</b>			24			
<b>Kehä 4</b>			24	8	1	3-3-3-4
<b>Kehä 5</b>			24	16	1	3-3-4-3-4
<b>Kehä 6</b>			24	24	1	3-4
<b>Kehä 7</b>			29	28	1	3-4
<b>Kehä 8</b>			24	40	3	3-4-3-4-3-4-4-3-4-4-3-4-3-4-4-4



LADONTAMALLIT

LAKAN BETONI OY

1:10

LADONTAESIMERKKI

27.4.2017

NURMIKIVI 80

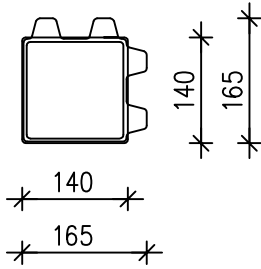

Menekki 36,8kpl/m<sup>2</sup>

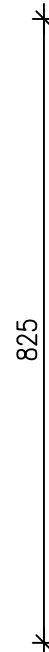
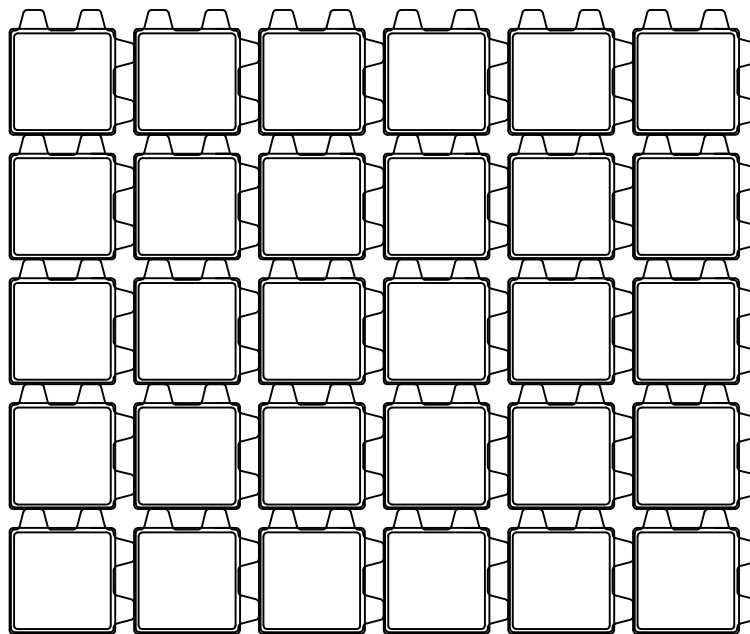
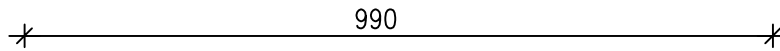

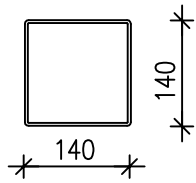
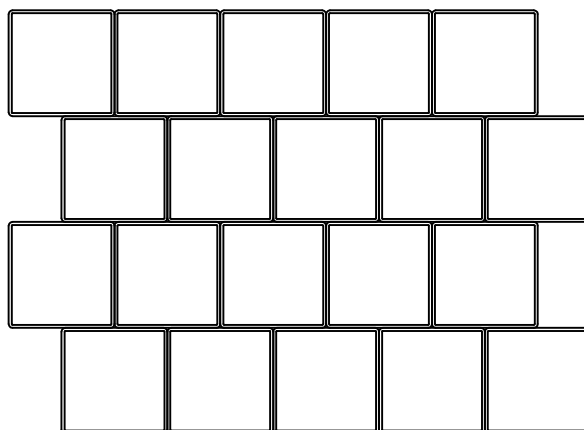
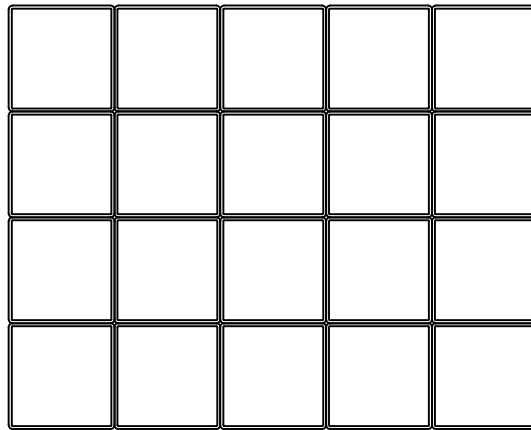
Menekki 52kpl/m<sup>2</sup>

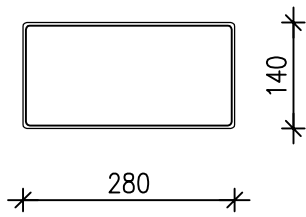
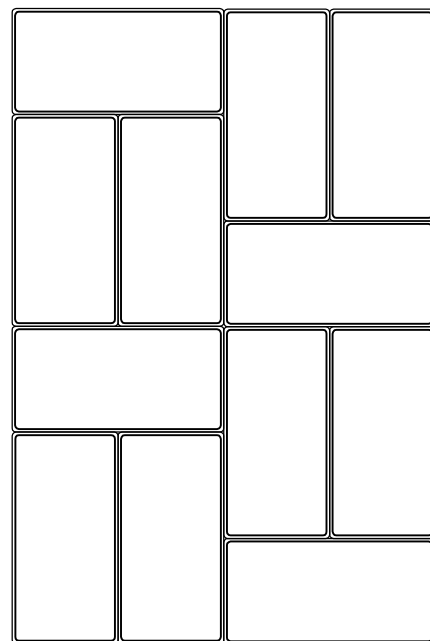
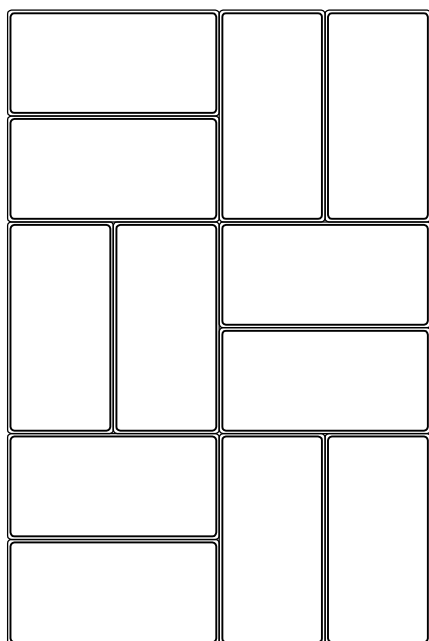
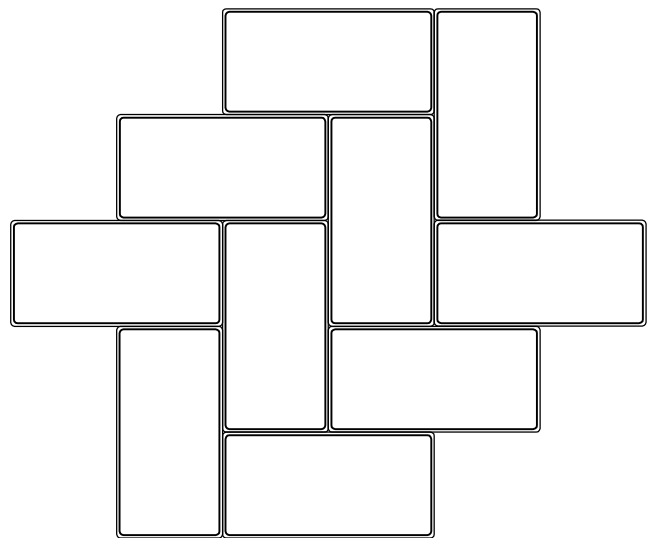
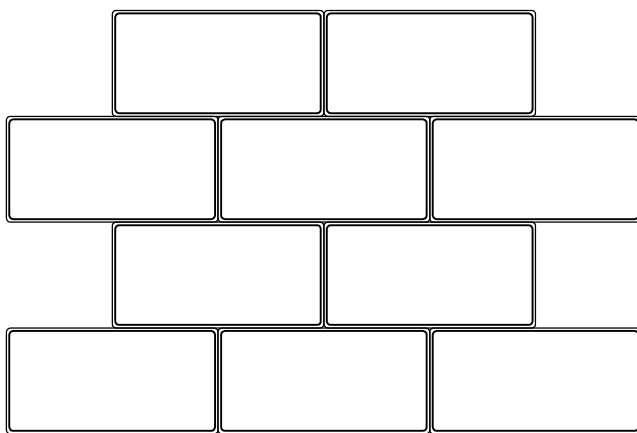
Menekki 26kpl/m<sup>2</sup>



LADONTAMALLIT

LAKAN BETONI OY

1:10

LADONTAESIMERKKEJÄ

24.5.2016

PIHALAATTA 60/ KATULAATTA 80

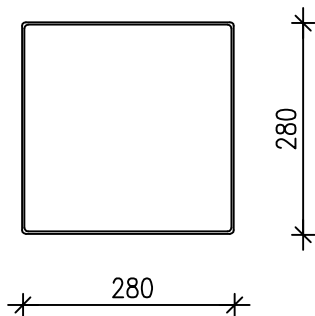

Menekki 12,8kpl/m<sup>2</sup>

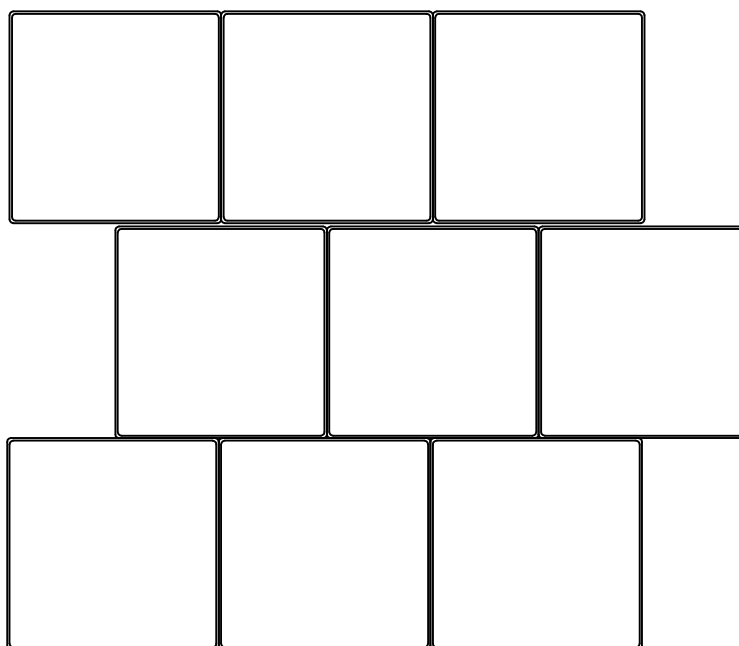
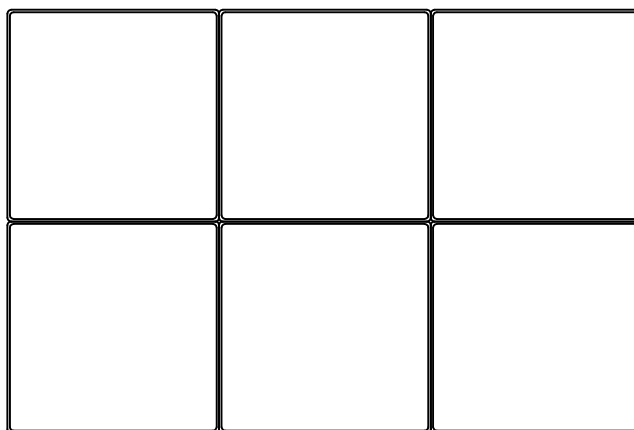

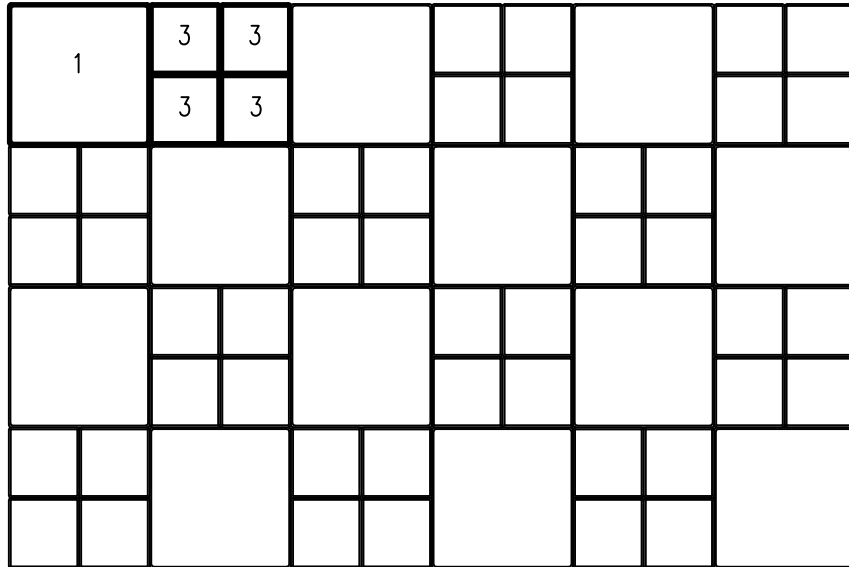
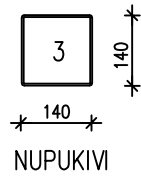
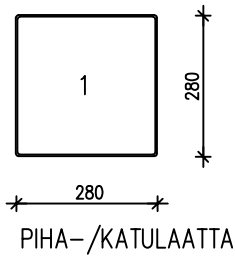

PIHALAATTA 60 TAI KATULAATTA 80 6,4 kpl/m<sup>2</sup> (50% pinta-alasta)  
 NUPUKIVI 60 TAI NUPUKIVI 80 26 kpl/m<sup>2</sup> (50% pinta-alasta)

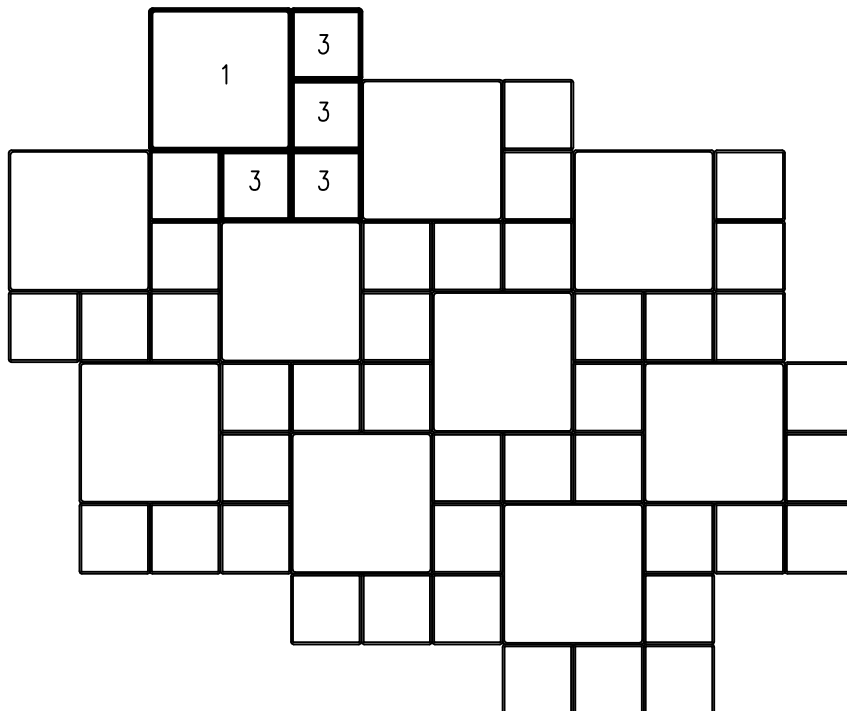

PIHALAATTA 60 TAI KATULAATTA 80 6,4 kpl/m<sup>2</sup> (50% pinta-alasta)  
 NUPUKIVI 60 TAI NUPUKIVI 80 6,4 kpl/m<sup>2</sup> (50% pinta-alasta)



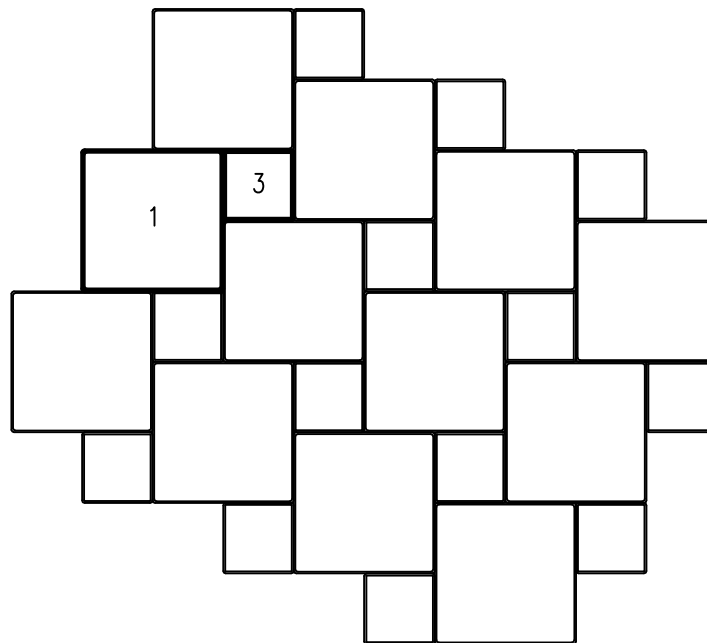
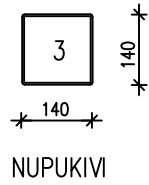
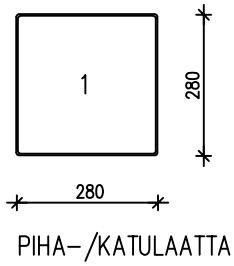

PIHALAATTA 60 TAI KATULAATTA 80 10,2 kpl/m<sup>2</sup> (80% pinta-alasta)  
 NUPUKIVI 60 TAI NUPUKIVI 80 10,2 kpl/m<sup>2</sup> (20% pinta-alasta)

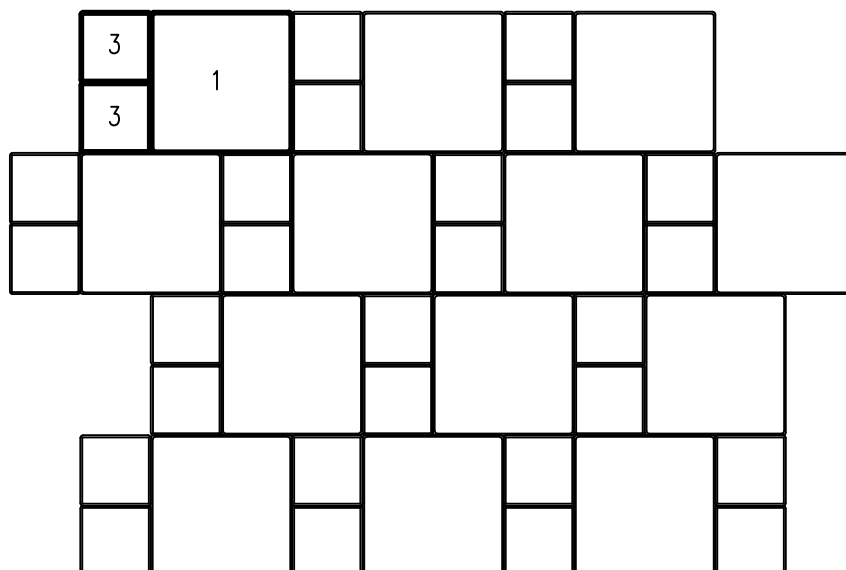

PIHALAATTA 60 TAI KATULAATTA 80 8,5 kpl/m<sup>2</sup> (67% pinta-alasta)  
 NUPUKIVI 60 TAI NUPUKIVI 80 17,3 kpl/m<sup>2</sup> (33% pinta-alasta)

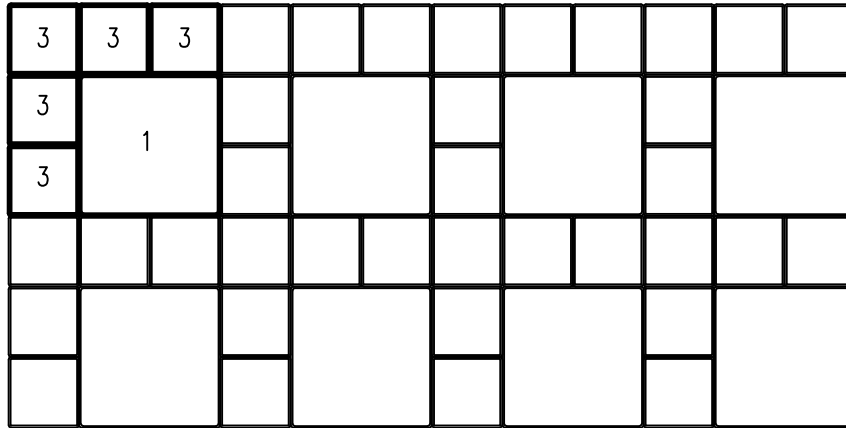
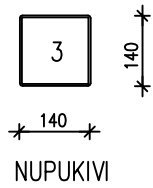
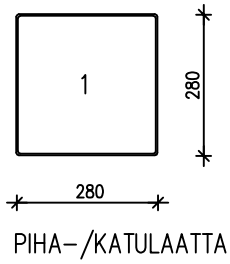

PIHALAATTA 60 TAI KATULAATTA 80 5,6 kpl/m<sup>2</sup> (44% pinta-alasta)  
 NUPUKIVI 60 TAI NUPUKIVI 80 29 kpl/m<sup>2</sup> (56% pinta-alasta)

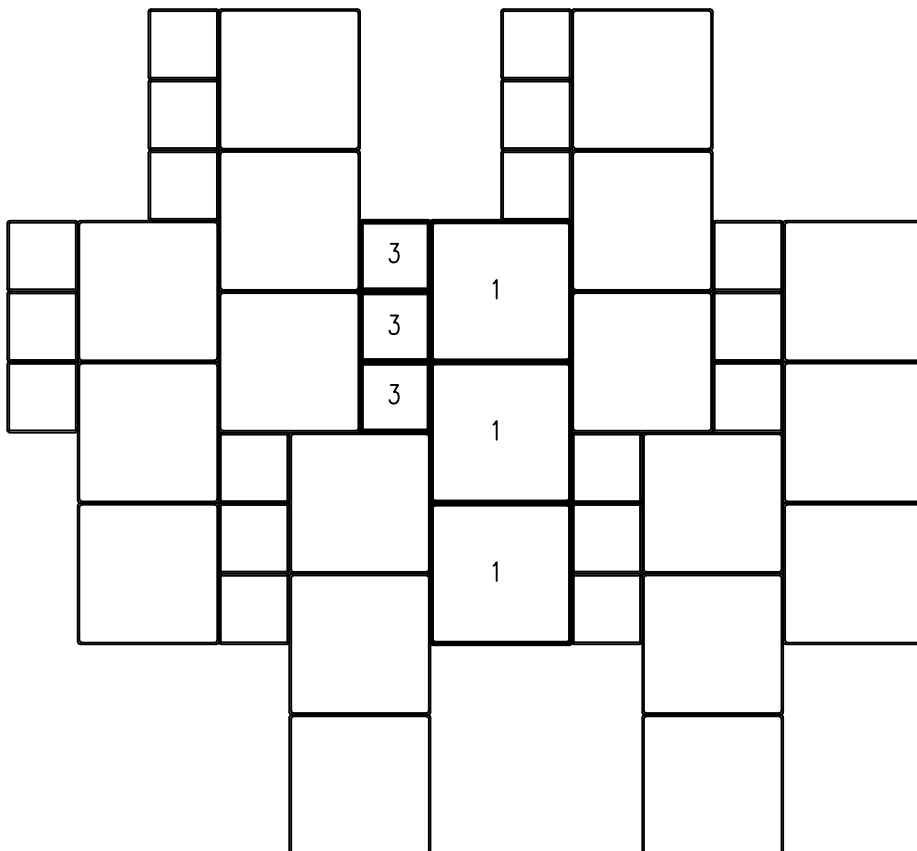

PIHALAATTA 60 TAI KATULAATTA 80 10,2 kpl/m<sup>2</sup> (80% pinta-alasta)  
 NUPUKIVI 60 TAI NUPUKIVI 80 10,2 kpl/m<sup>2</sup> (20% pinta-alasta)

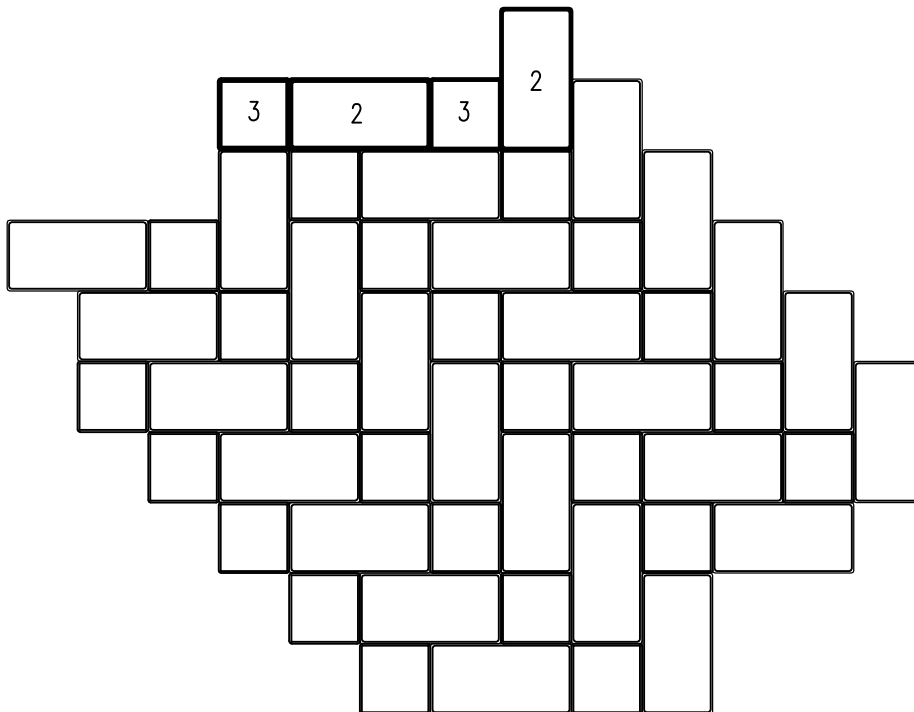
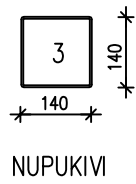
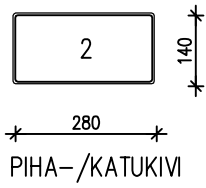

PIHAKIVI 60 TAI KATUKIVI 80 17,3 kpl/m<sup>2</sup> (67% pinta-alasta)  
 NUPUKIVI 60 TAI NUPUKIVI 80 17,3 kpl/m<sup>2</sup> (33% pinta-alasta)

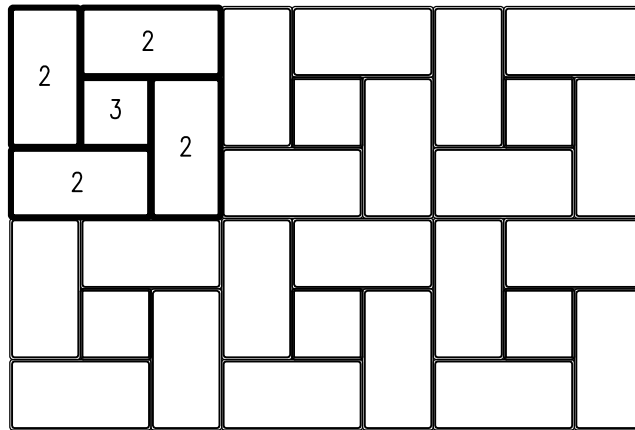
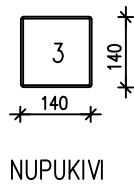
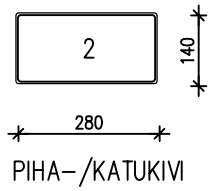

PIHAKIVI 60 TAI KATUKIVI 80 23 kpl/m<sup>2</sup> (89% pinta-alasta)  
 NUPUKIVI 60 TAI NUPUKIVI 80 6 kpl/m<sup>2</sup> (11% pinta-alasta)

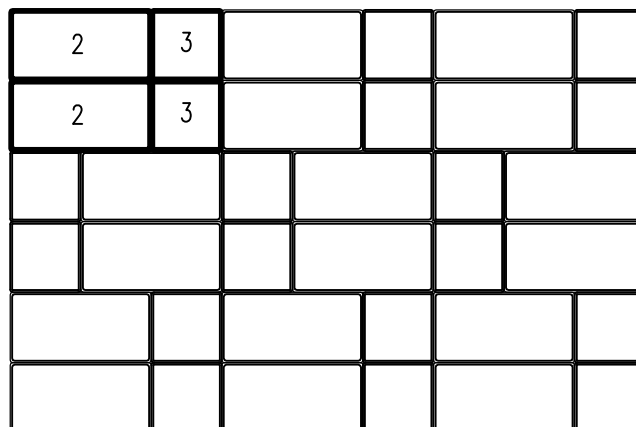

PIHAKIVI 60 TAI KATUKIVI 80 17,2 kpl/m<sup>2</sup> (67% pinta-alasta)  
 NUPUKIVI 60 TAI NUPUKIVI 80 17,2kpl/m<sup>2</sup> (33% pinta-alasta)

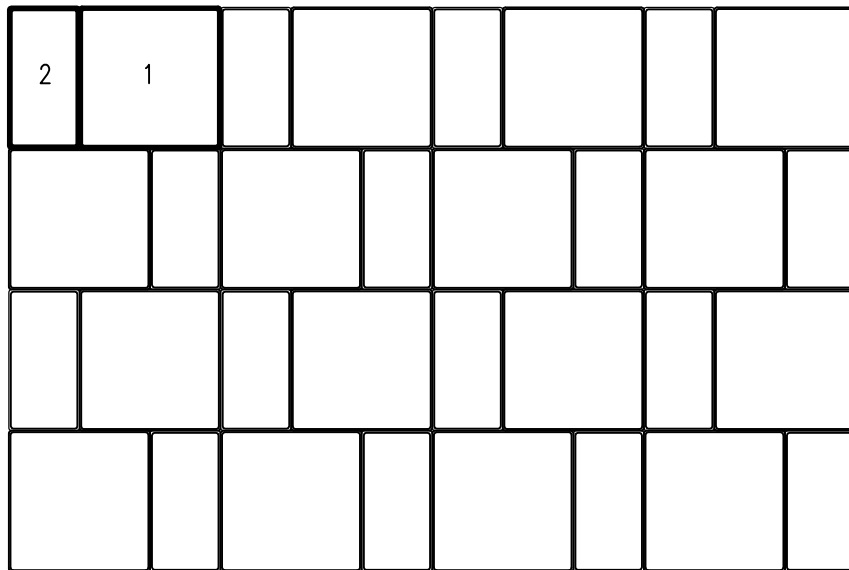
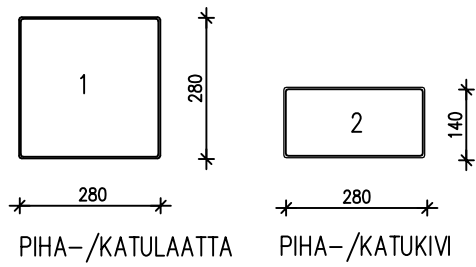

PIHALAATTA 60 TAI KATULAATTA 80 8,5 kpl/m<sup>2</sup> (67% pinta-alasta)  
 PIHAKIVI 60 TAI KATUKIVI 80 8,5 kpl/m<sup>2</sup> (33% pinta-alasta)

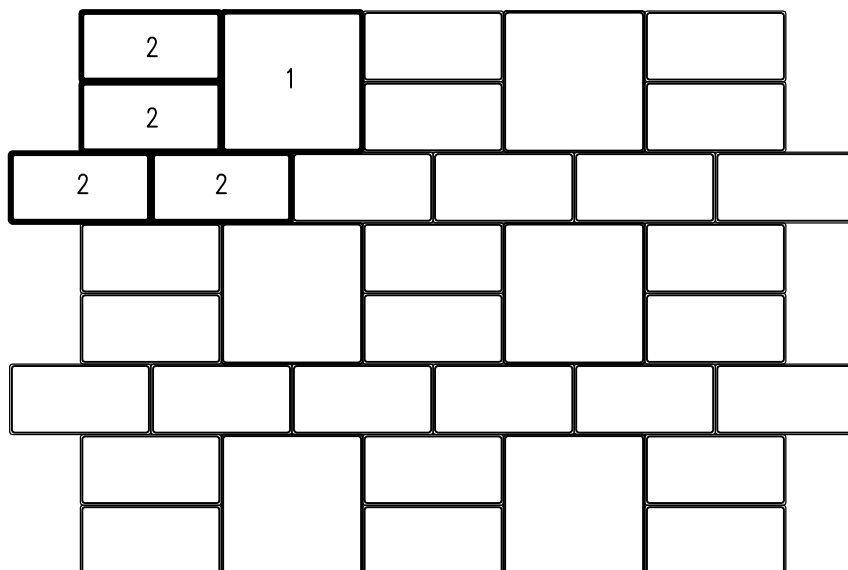

PIHALAATTA 60 TAI KATULAATTA 80 4,2 kpl/m<sup>2</sup> (33% pinta-alasta)  
 PIHAKIVI 60 TAI KATUKIVI 80 17,5 kpl/m<sup>2</sup> (67% pinta-alasta)

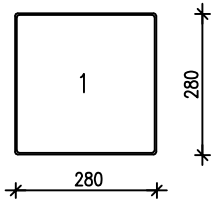

PIHA-/KATULAATTA

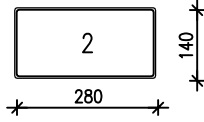

PIHA-/KATUKIVI

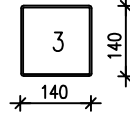

NUPUKIVI

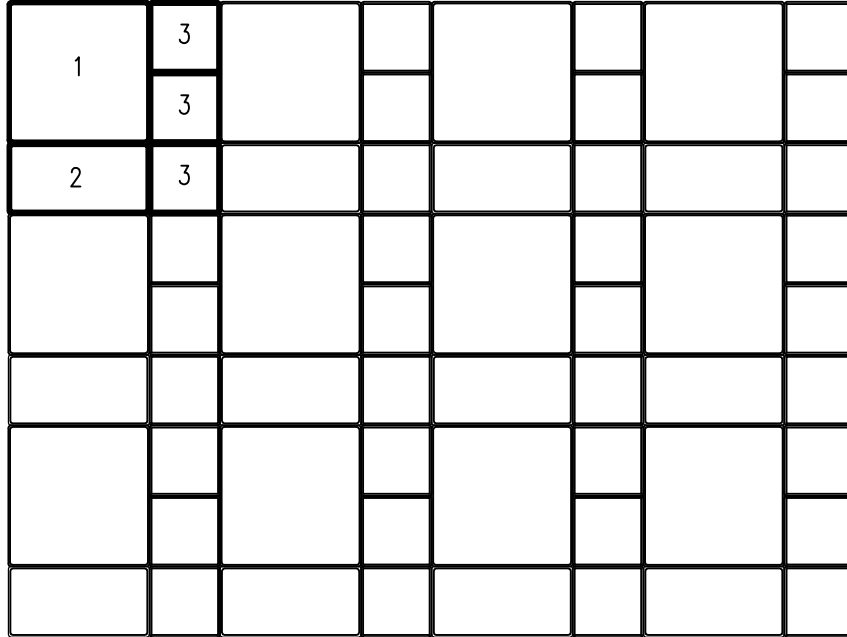

PIHALAATTA 60 TAI KATULAATTA 80 5,7 kpl/m<sup>2</sup> (45% pinta-alasta)

PIHAKIVI 60 TAI KATUKIVI 80 5,7 kpl/m<sup>2</sup> (22% pinta-alasta)

NUPUKIVI 60 TAI NUPUKIVI 80 17 kpl/m<sup>2</sup> (33% pinta-alasta)

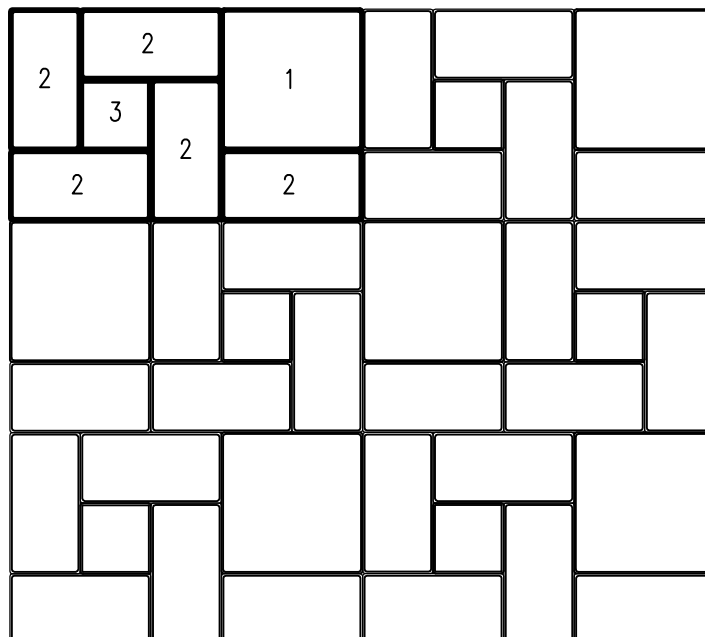

PIHALAATTA 60 TAI KATULAATTA 80 3,5 kpl/m<sup>2</sup> (26,6% pinta-alasta)

PIHAKIVI 60 TAI KATUKIVI 80 17,3 kpl/m<sup>2</sup> (66,7% pinta-alasta)

NUPUKIVI 60 TAI NUPUKIVI 80 3,5 kpl/m<sup>2</sup> (6,7% pinta-alasta)

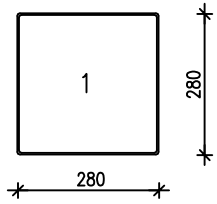

PIHA- /KATULAATTA

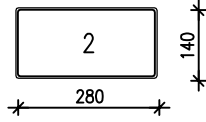

PIHA- /KATUKIVI

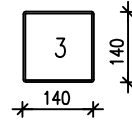

NUPUKIVI

3	2	2				
2	1	1				
2	1	1				

PIHALAATTA 60 TAI KATULAATTA 80 8,2 kpl/m<sup>2</sup> (64% pinta-alasta)  
 PIHAKIVI 60 TAI KATUKIVI 80 8,2 kpl/m<sup>2</sup> (32% pinta-alasta)  
 NUPUKIVI 60 TAI NUPUKIVI 80 2kpl/m<sup>2</sup> (4% pinta-alasta)

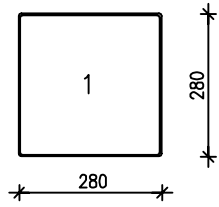

PIHA- /KATULAATTA

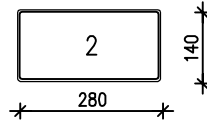

PIHA- /KATUKIVI

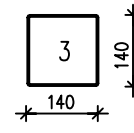

NUPUKIVI

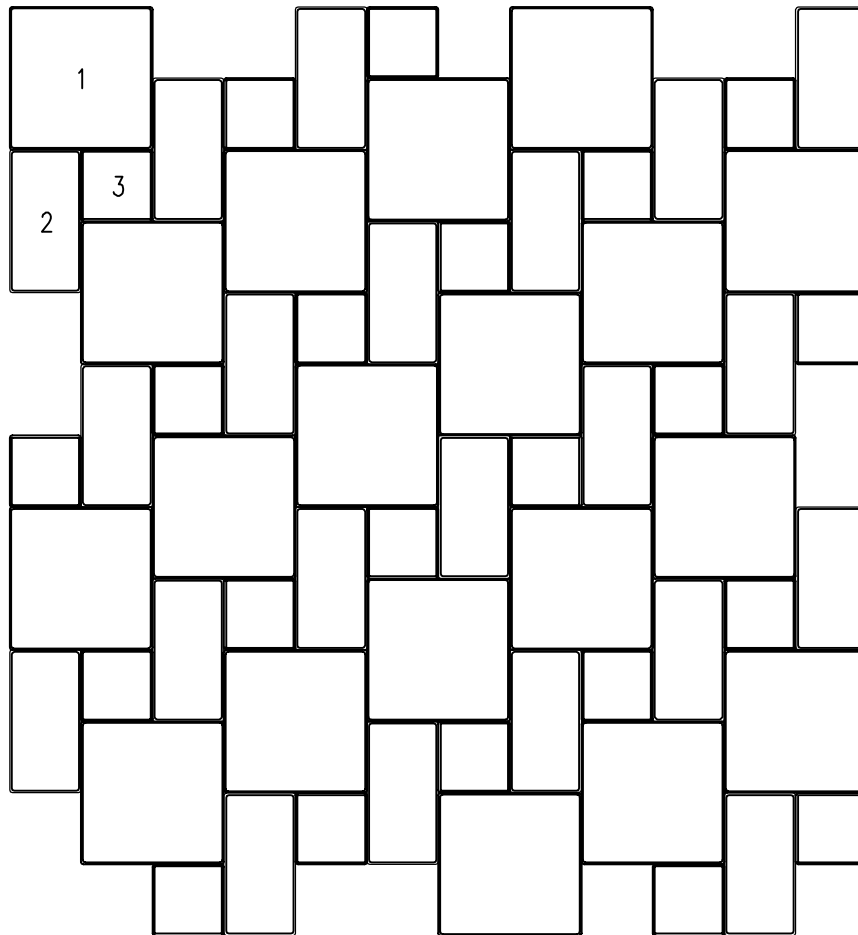

PIHALAATTA 60 TAI KATULAATTA 80 7,1 kpl/m<sup>2</sup> (56% pinta-alasta)

PIHAKIVI 60 TAI KATUKIVI 80 7,6 kpl/m<sup>2</sup> (29% pinta-alasta)

NUPUKIVI 60 TAI NUPUKIVI 80 7,8kpl/m<sup>2</sup> (15% pinta-alasta)



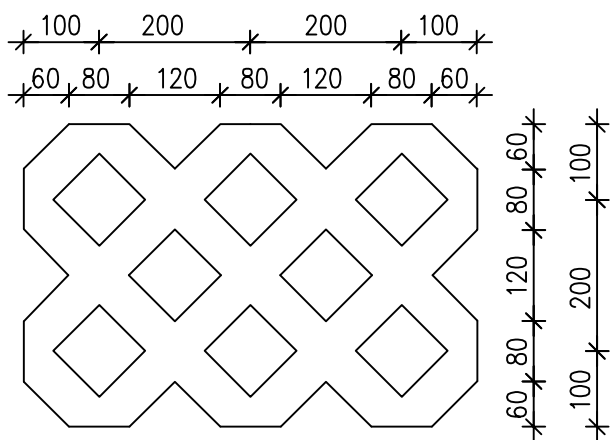

Menekki 4,17kpl/m<sup>2</sup>

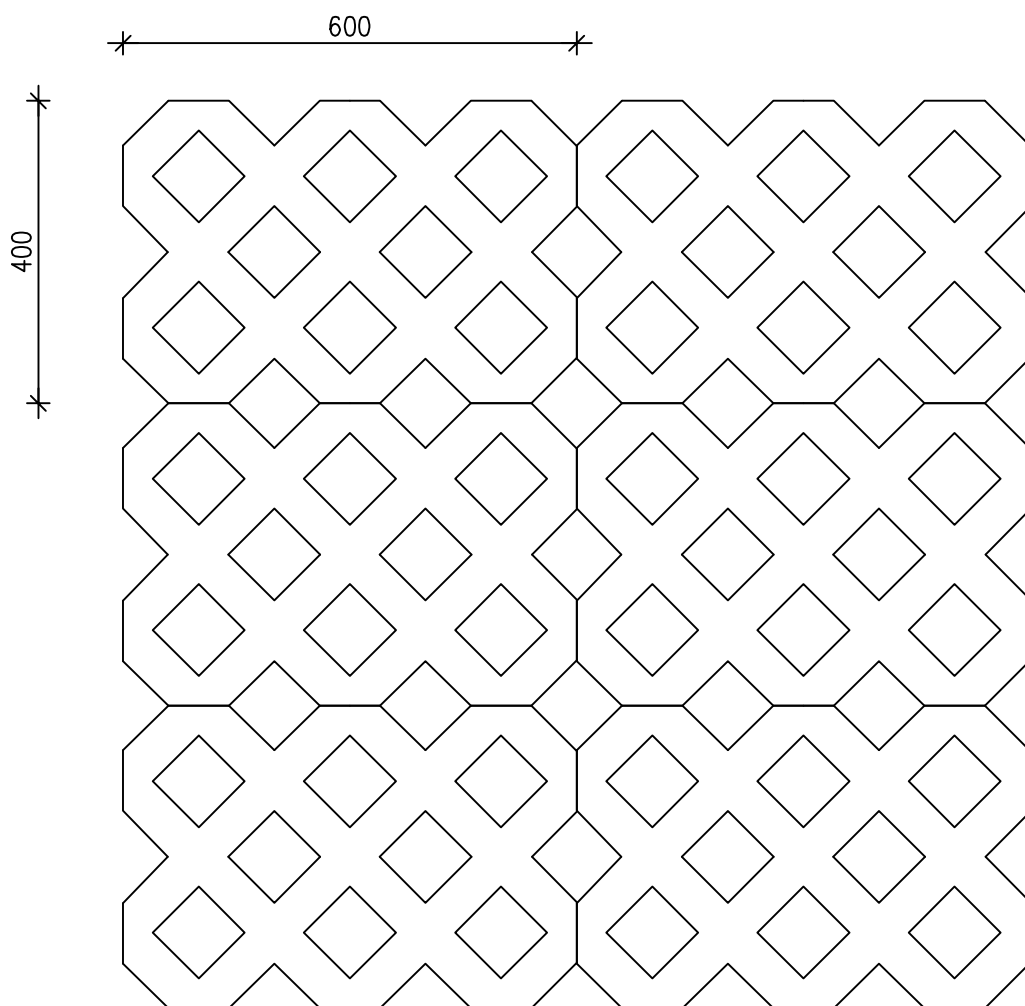

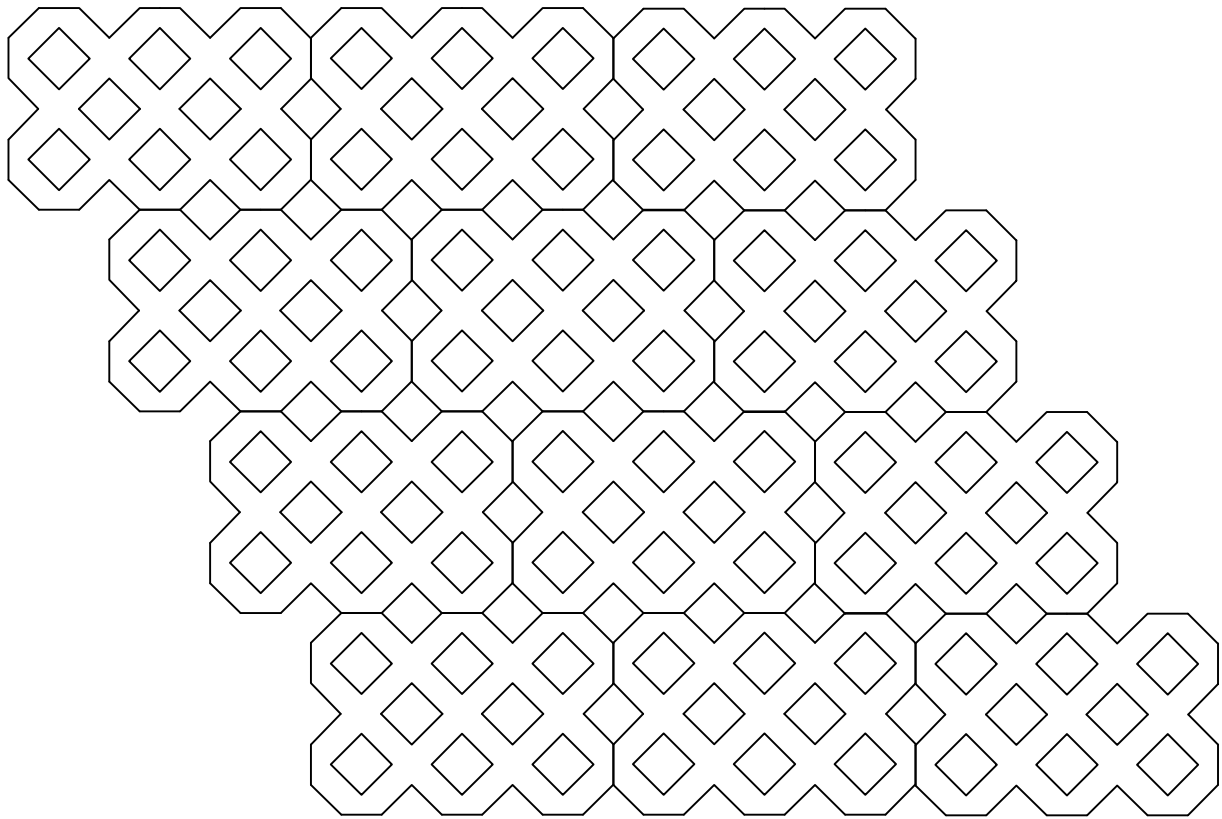

REIKÄLAATAN LIMITYKSELLÄ VOIDAAN HÄVITTÄÄ SAUMOJEN NÄKYVYYTTÄ

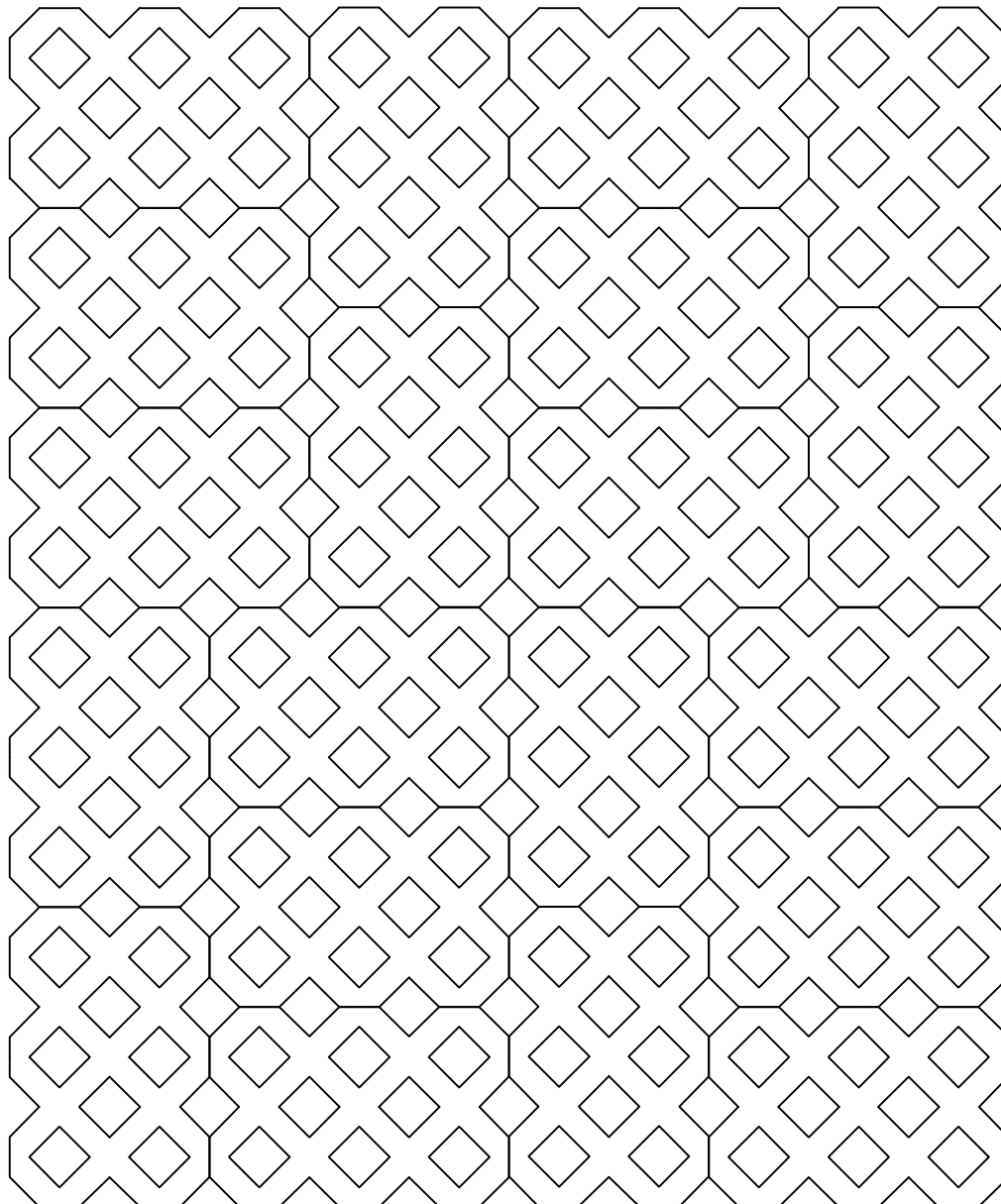

REIKÄLAATAN LIMITYKSELLÄ VOIDAAN HÄVITTÄÄ SAUMOJEN NÄKYVYYTTÄ

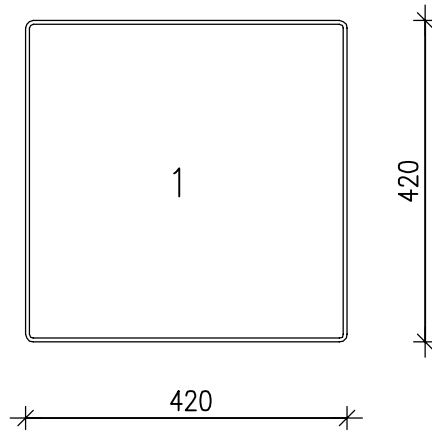

Roomalainen kivi 418x418x80  
Menekki 5,7kpl/m<sup>2</sup>

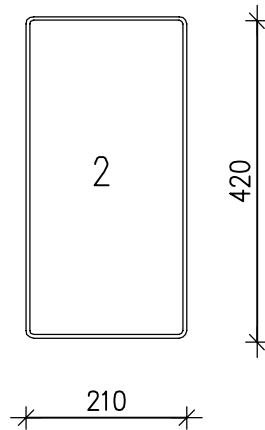

Roomalainen kivi 418x418x80  
Menekki 11,4kpl/m<sup>2</sup>

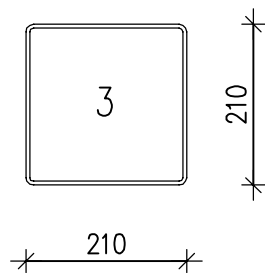

Roomalainen kivi 208x208x80  
Menekki 23,1kpl/m<sup>2</sup>

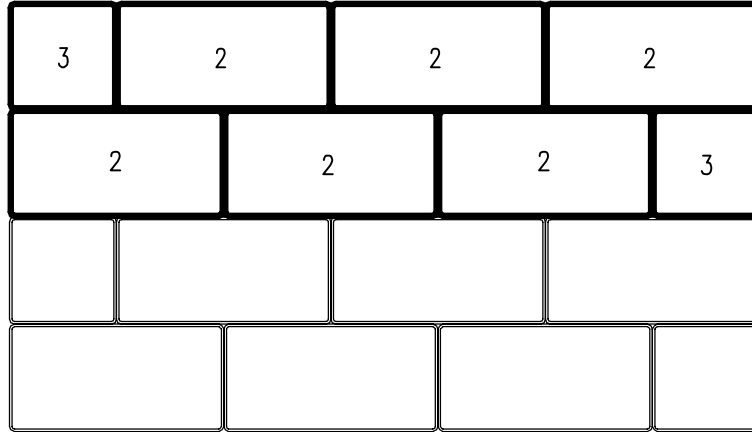

ROOMALAINEN KIVI (2) 210x420 4,9kpl/m<sup>2</sup> (85,7% pinta-alasta)  
 ROOMALAINEN KIVI (3) 210x210 3,3kpl/m<sup>2</sup> (14,3% pinta-alasta)

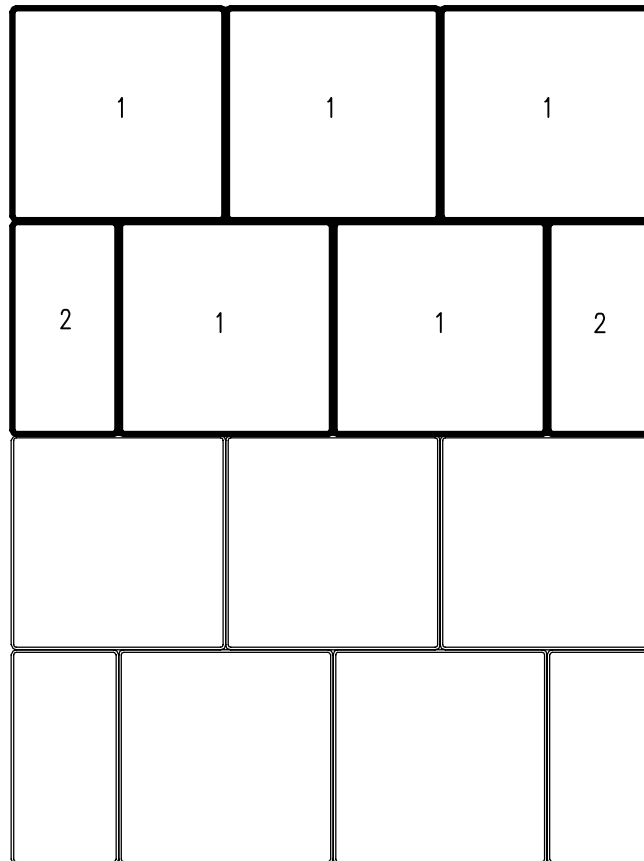

ROOMALAINEN KIVI (1) 420x420 4,7kpl/m<sup>2</sup> (83,3% pinta-alasta)  
 ROOMALAINEN KIVI (2) 210x420 2kpl/m<sup>2</sup> (16,7% pinta-alasta)

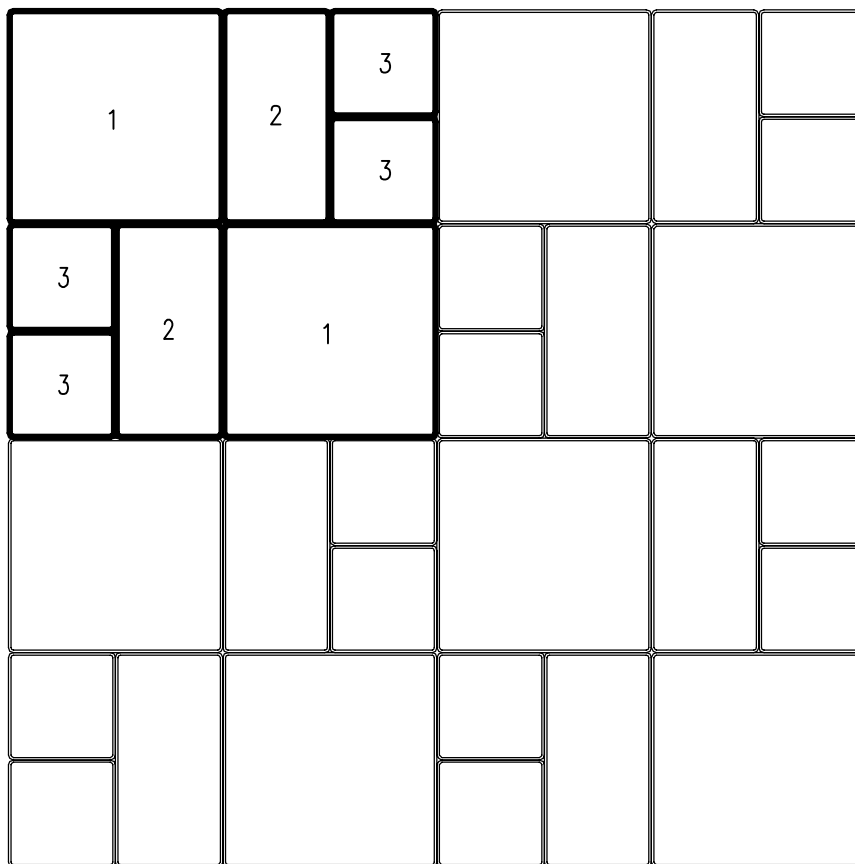

ROOMALAINEN KIVI (1) 420x420 2,85 kpl/m<sup>2</sup> (50% pinta-alasta)

ROOMALAINEN KIVI (2) 210x420 2,85kpl/m<sup>2</sup> (25% pinta-alasta)

ROOMALAINEN KIVI (3) 210x210 5,7kpl/m<sup>2</sup> (25% pinta-alasta)

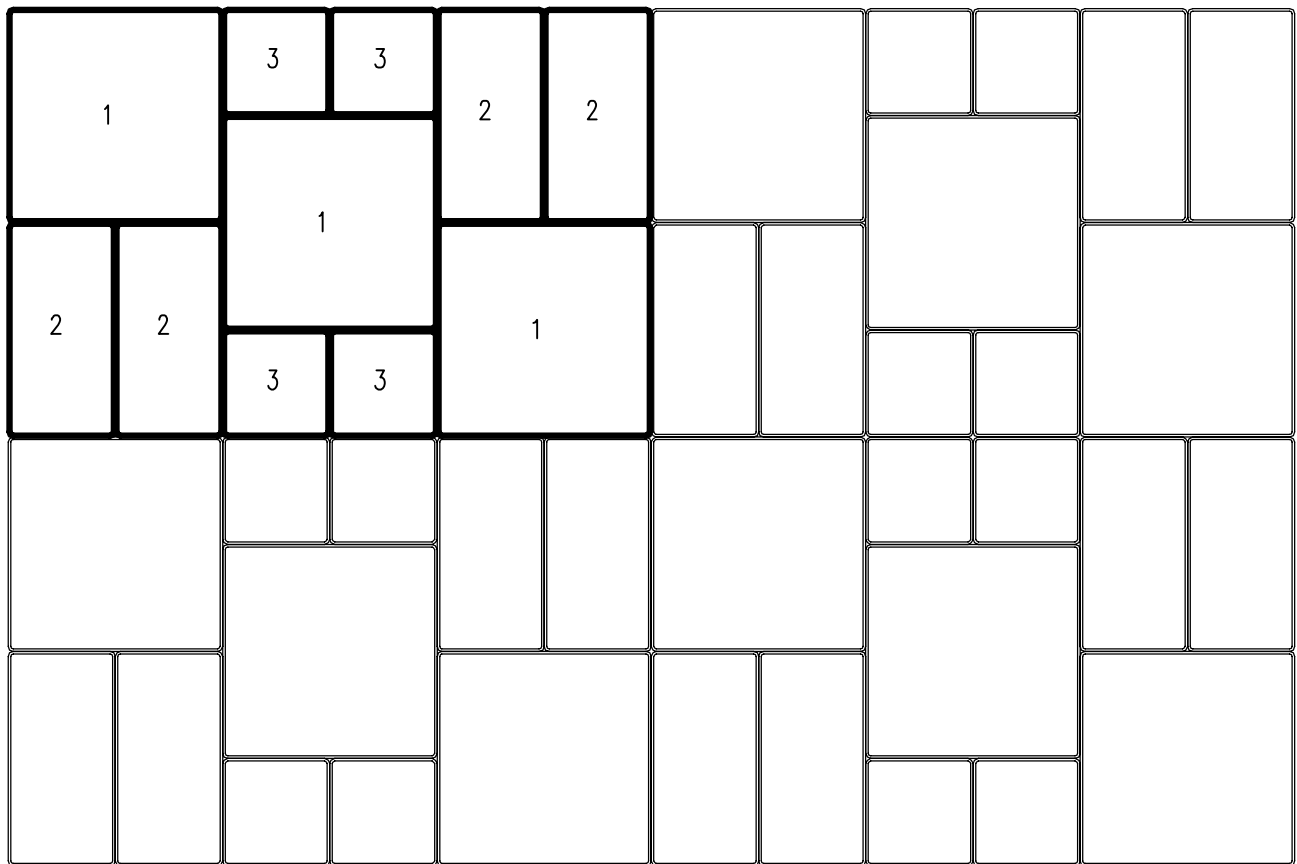

ROOMALAINEN KIVI (1) 420x420 2,85 kpl/m<sup>2</sup> (50% pinta-alasta)

ROOMALAINEN KIVI (2) 210x420 7,6kpl/m<sup>2</sup> (33% pinta-alasta)

ROOMALAINEN KIVI (3) 210x210 3,85kpl/m<sup>2</sup> (17% pinta-alasta)

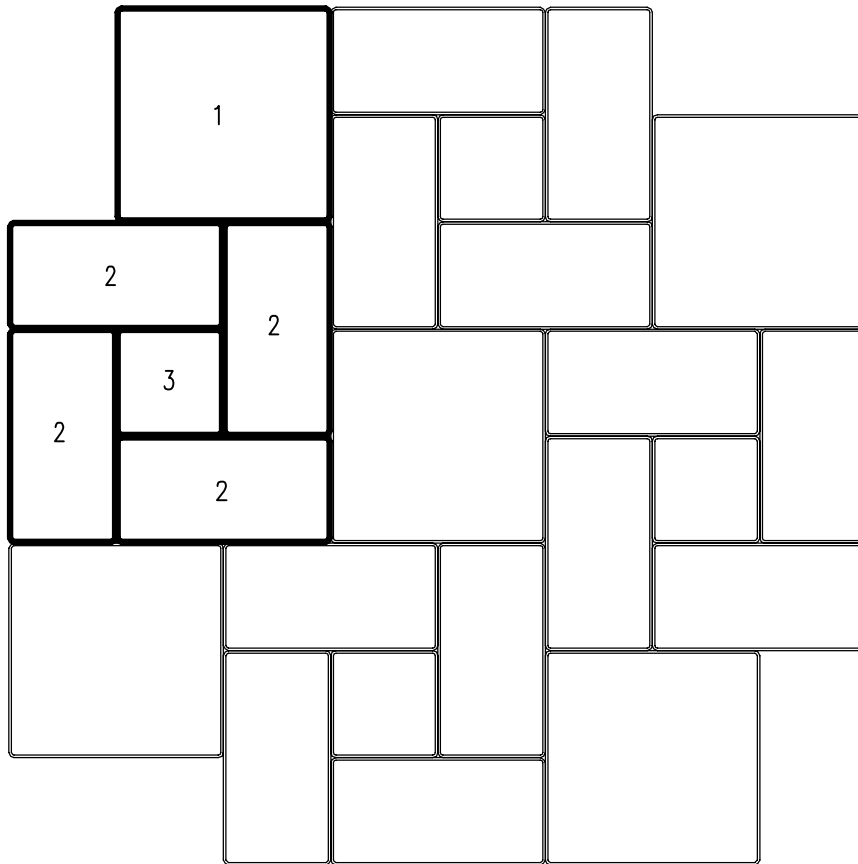

ROOMALAINEN KIVI (1) 420x420 1,8 kpl/m<sup>2</sup> (31% pinta-alasta)  
ROOMALAINEN KIVI (2) 210x420 7,0kpl/m<sup>2</sup> (62% pinta-alasta)  
ROOMALAINEN KIVI (3) 210x210 1,7kpl/m<sup>2</sup> (8% pinta-alasta)



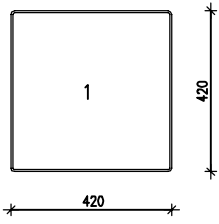

Menekki 5,7kpl/m<sup>2</sup>

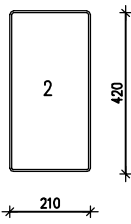

Menekki 11,4kpl/m<sup>2</sup>

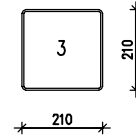

Menekki 23,1kpl/m<sup>2</sup>

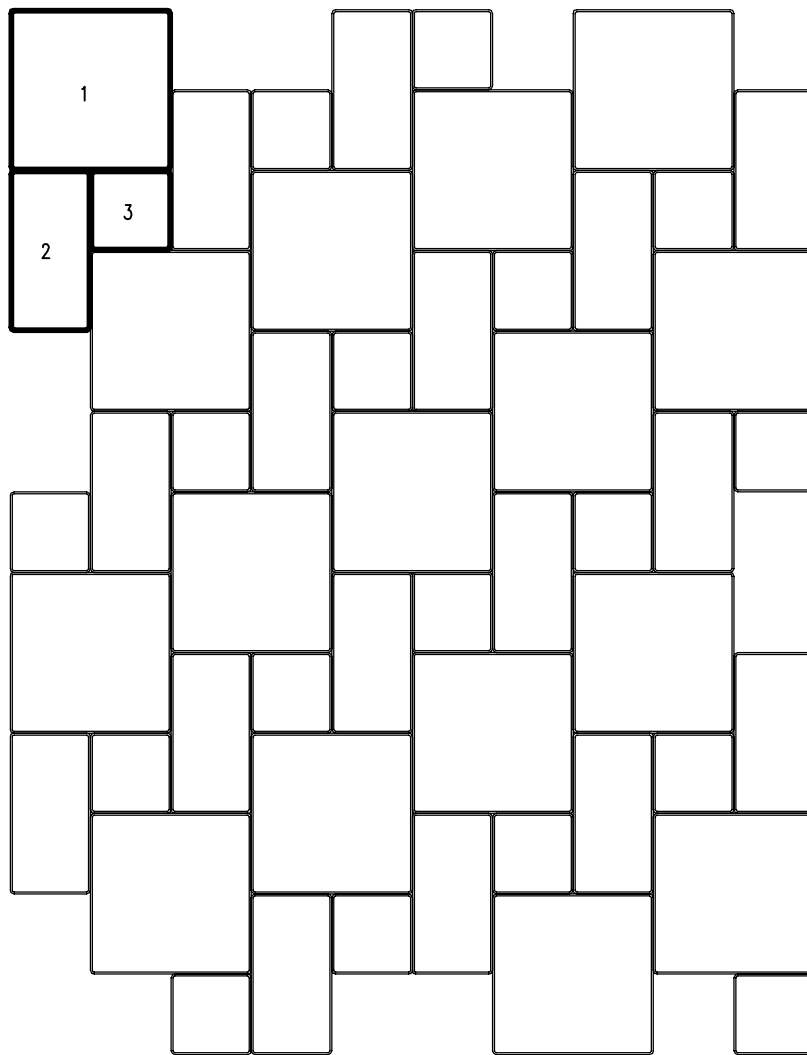

ROOMALAINEN KIVI (1) 420x420 3,2 kpl/m<sup>2</sup> (56% pinta-alasta)  
 ROOMALAINEN KIVI (2) 210x420 3,3kpl/m<sup>2</sup> (29% pinta-alasta)  
 ROOMALAINEN KIVI (3) 210x210 3,6kpl/m<sup>2</sup> (15% pinta-alasta)

ROOMALAISET ISOT KIVET –KIVISARJA

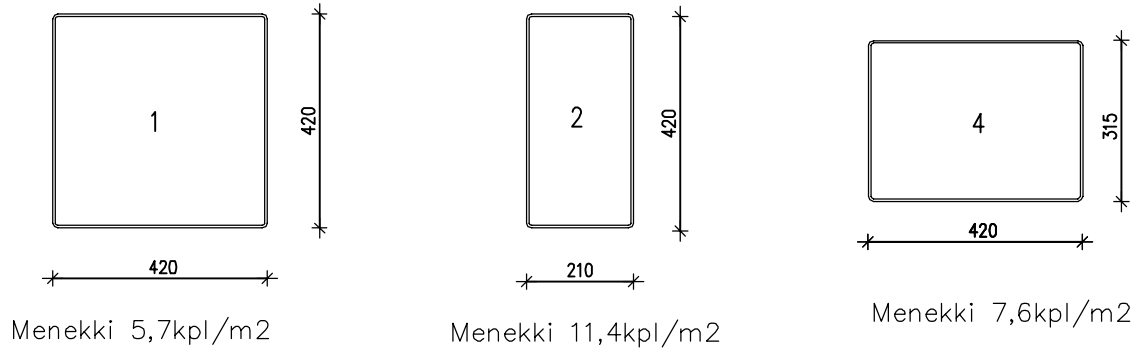

LADONTAKUVIO KUORMALAVALLA

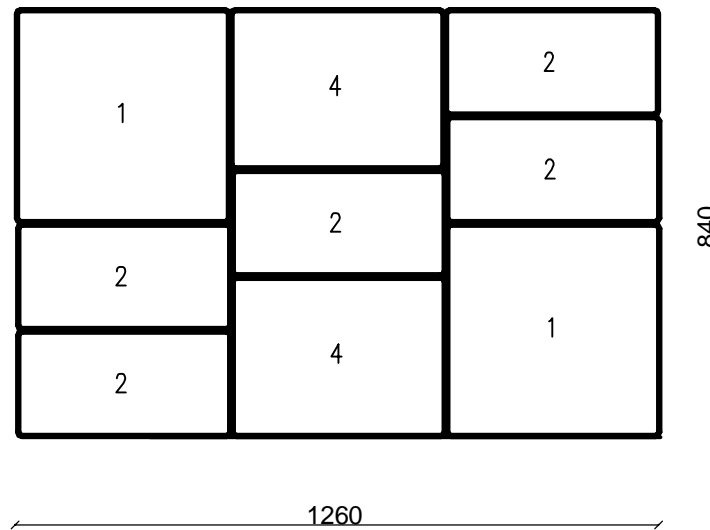

ROOMALAINEN KIVI (1) 420x420 1,9 kpl/m<sup>2</sup> (34% pinta-alasta)  
 ROOMALAINEN KIVI (2) 420x210 2,9kpl/m<sup>2</sup> (42% pinta-alasta)  
 ROOMALAINEN KIVI (4) 420x315 1,9kpl/m<sup>2</sup> (25% pinta-alasta)

## ROOMALAISET PIENET KIVET-KIVISARJA

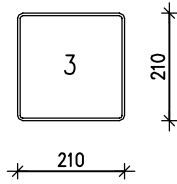

Menekki 23,1kpl/m<sup>2</sup>

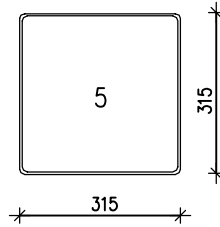

Menekki 10kpl/m<sup>2</sup>

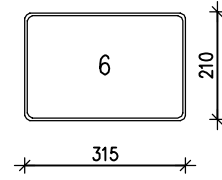

Menekki 15,1kpl/m<sup>2</sup>

## LADONTAKUVIO KUORMALAVALLA

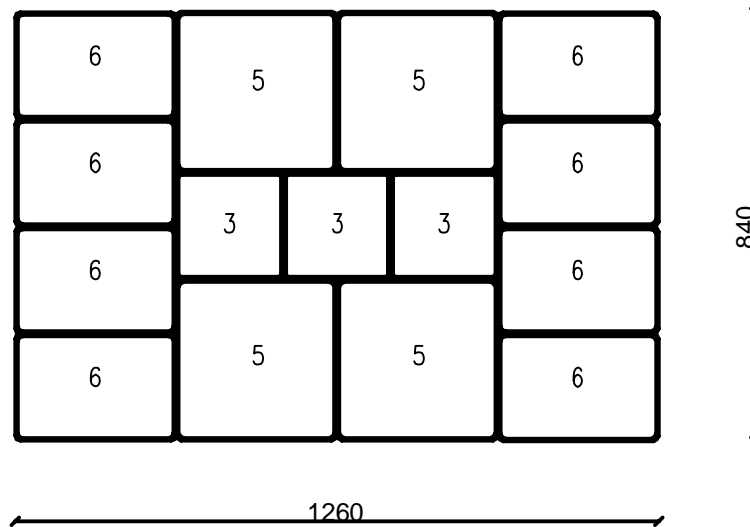

ROOMALAINEN KIVI (3) 210x210 2,9 kpl/m<sup>2</sup> (12,5% pinta-alasta)  
 ROOMALAINEN KIVI (5) 315x315 3,8kpl/m<sup>2</sup> (37,5% pinta-alasta)  
 ROOMALAINEN KIVI (6) 315x210 7,6kpl/m<sup>2</sup> (50% pinta-alasta)

ROOMALAINEN LADONTA, 6 ERI KOKOISTA KIVEÄ  
 -ROOMALAISET ISOT KIVET -KIVISARJA  
 -ROOMALAISET PIENET KIVET -KIVISARJA

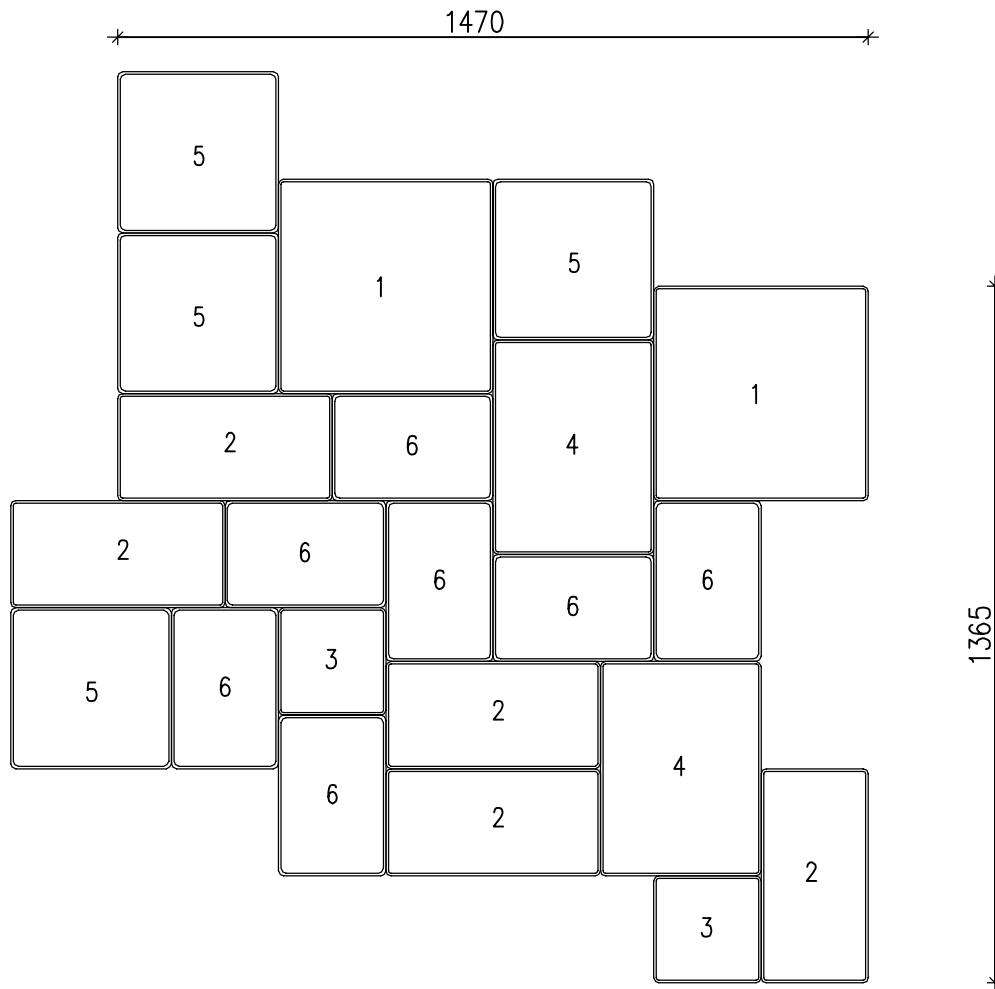

- ROOMALAINEN KIVI (1) 420x420 1 kpl/m<sup>2</sup> (17,5% pinta-alasta)  
 ROOMALAINEN KIVI (2) 210x420 2,5kpl/m<sup>2</sup> (22% pinta-alasta)  
 ROOMALAINEN KIVI (3) 210x210 1kpl/m<sup>2</sup> (4,5% pinta-alasta)  
 ROOMALAINEN KIVI (4) 420x315 0,5kpl/m<sup>2</sup> (13,2% pinta-alasta)  
 ROOMALAINEN KIVI (5) 315x315 2kpl/m<sup>2</sup> (19,8% pinta-alasta)  
 ROOMALAINEN KIVI (6) 315x210 3,5kpl/m<sup>2</sup> (23% pinta-alasta)

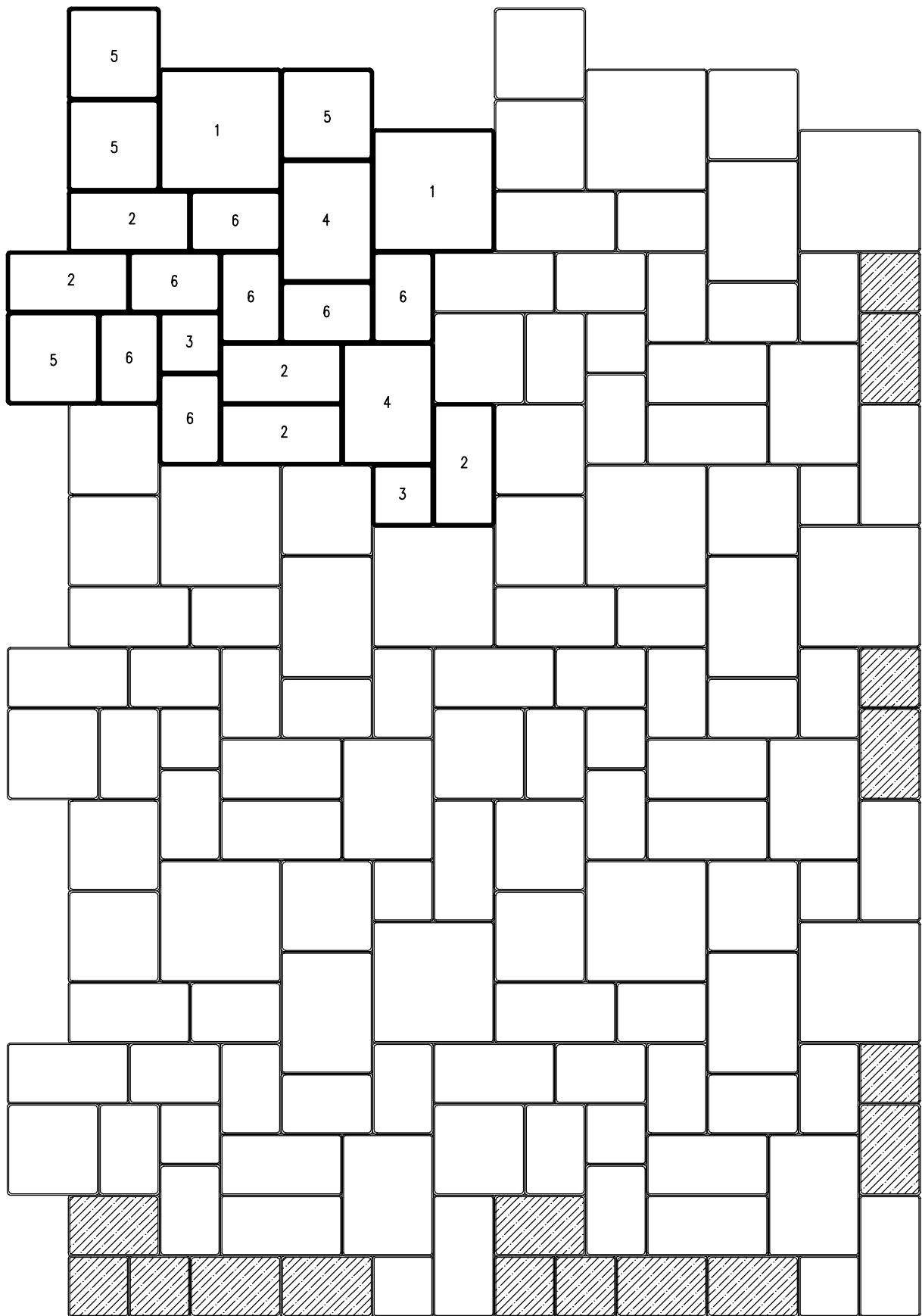

LAATOITUKSEN REUNA SAADAAN SUORAKSI  
 TUMMENNETUILLA KIVILLÄ:  
 210X210, 315X210

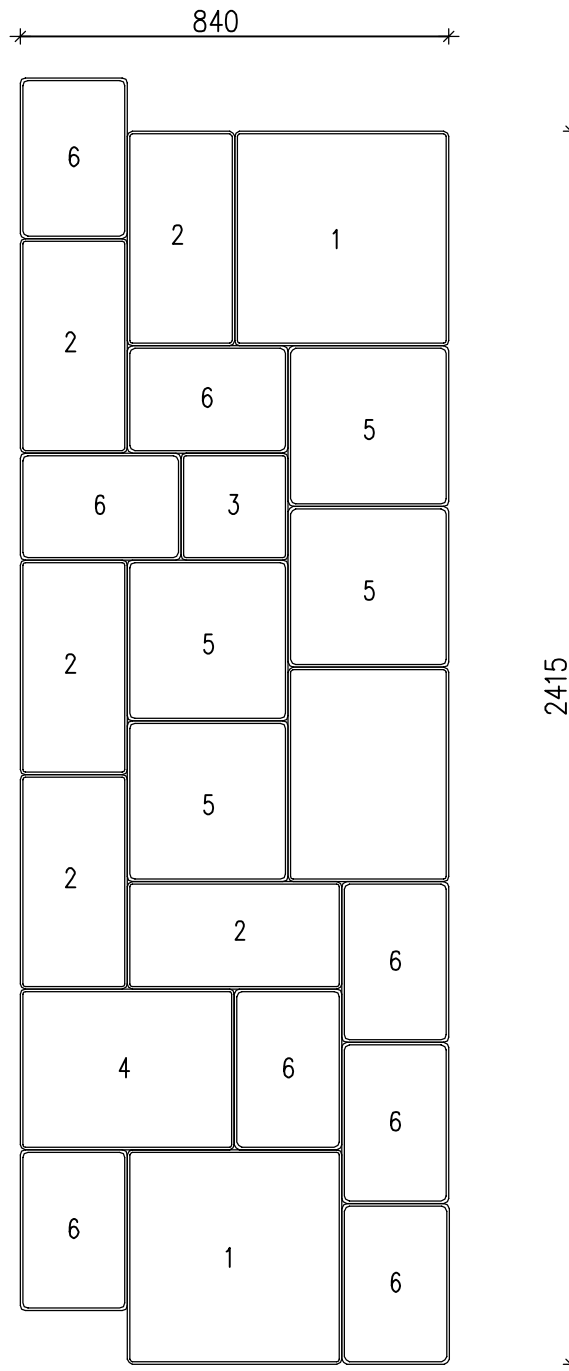

- ROOMALAINEN KIVI (1) 420x420 (17,4% pinta-alasta)
- ROOMALAINEN KIVI (2) 210x420 (21,7% pinta-alasta)
- ROOMALAINEN KIVI (3) 210x210 (2,2% pinta-alasta)
- ROOMALAINEN KIVI (4) 420x315 (13% pinta-alasta)
- ROOMALAINEN KIVI (5) 315x315 (19,6% pinta-alasta)
- ROOMALAINEN KIVI (6) 315x210 (26,1% pinta-alasta)

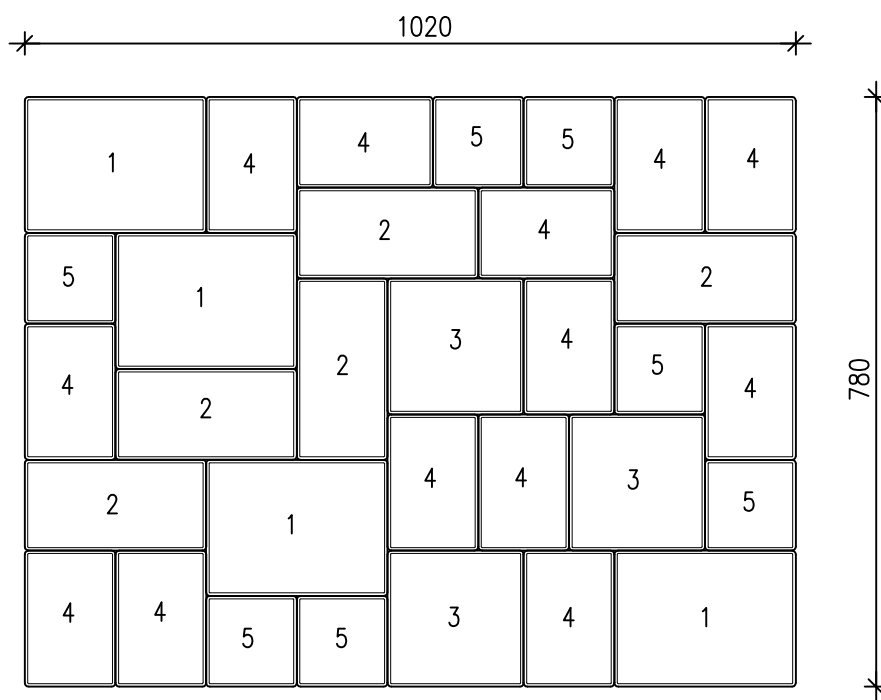
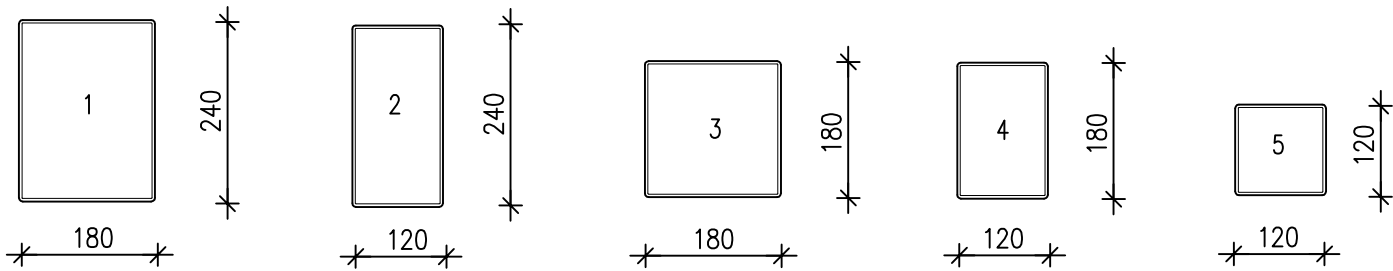

VALMIS LADONTAKUVIO LAVAKERROKSISSA 0,8 m<sup>2</sup>

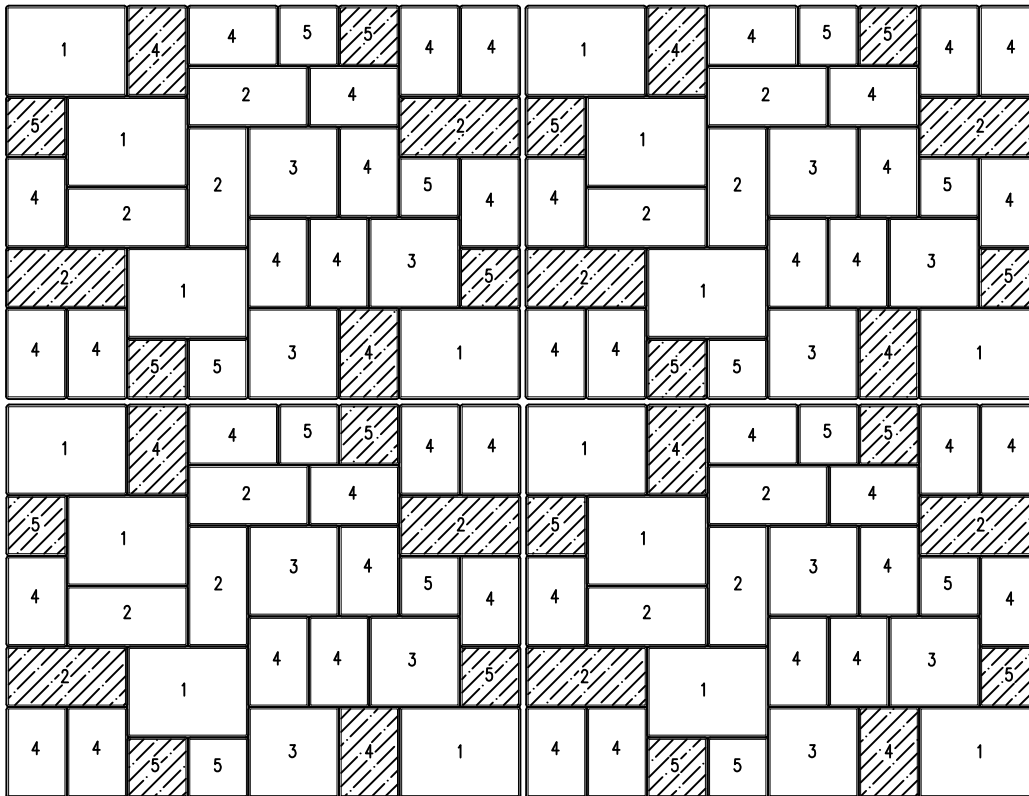

PITKÄT SUORAT SAUMAT VOIDAAN HÄVITTÄÄ VAIHTAMALLA TUMMENNETTUIJEN KIVIEN PAIKKAA KESKENÄÄN.

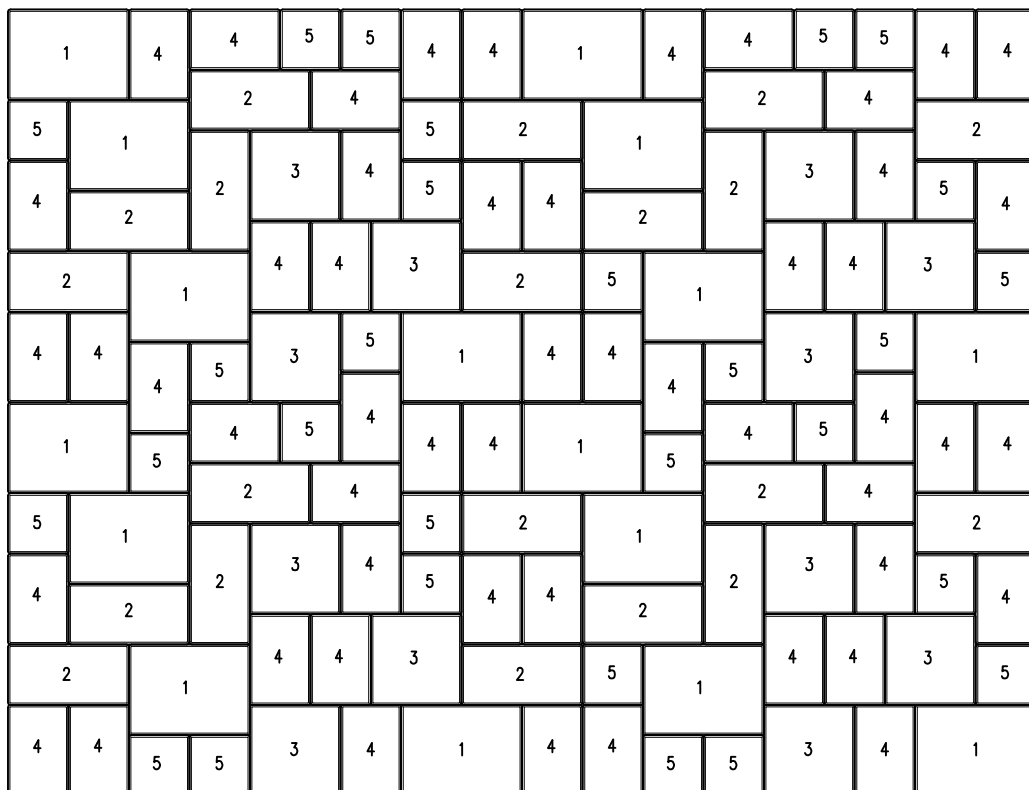



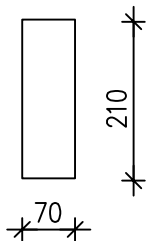

Menekki 68 kpl/m<sup>2</sup>

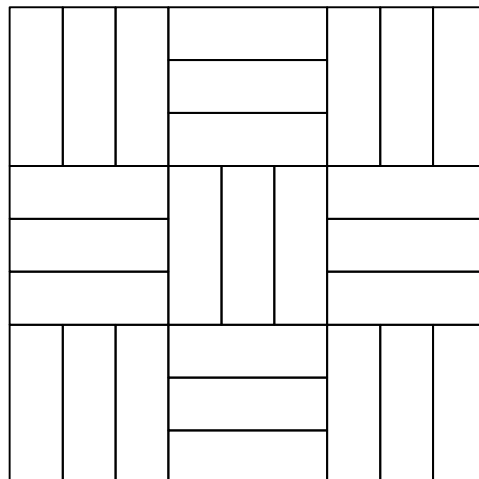
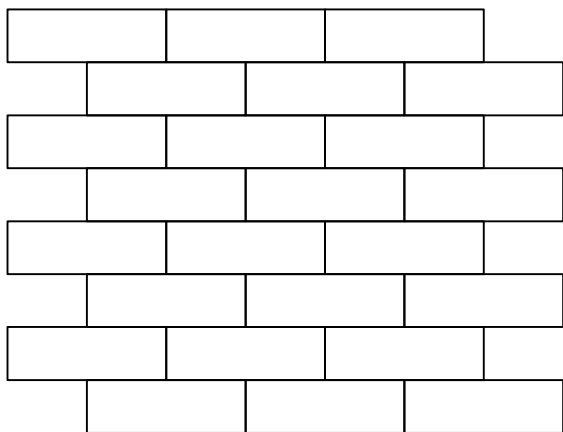
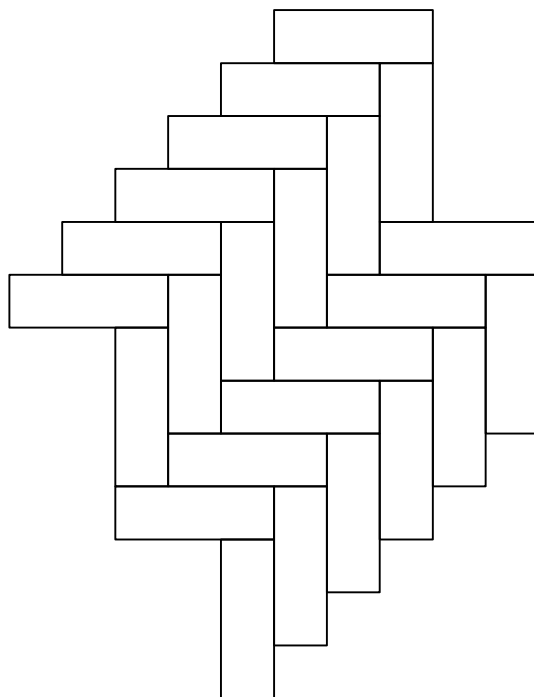

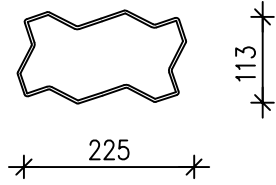

Menekki 40kpl/m<sup>2</sup>

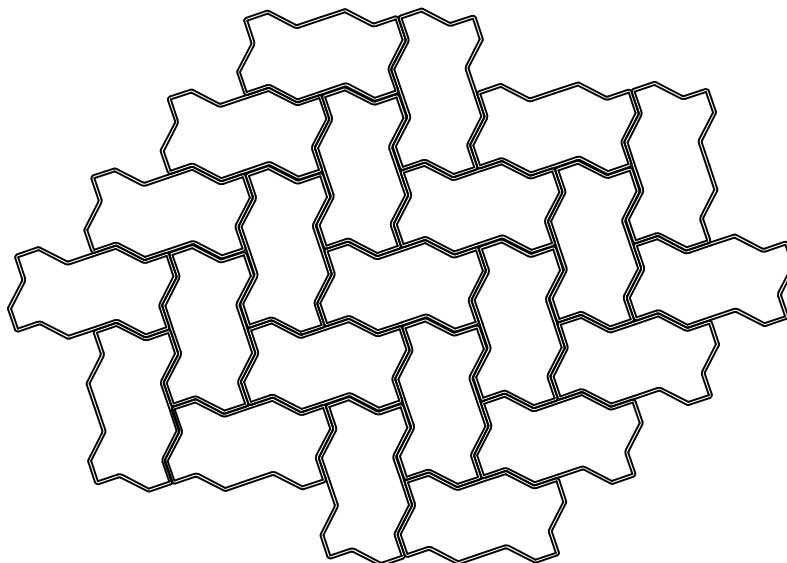
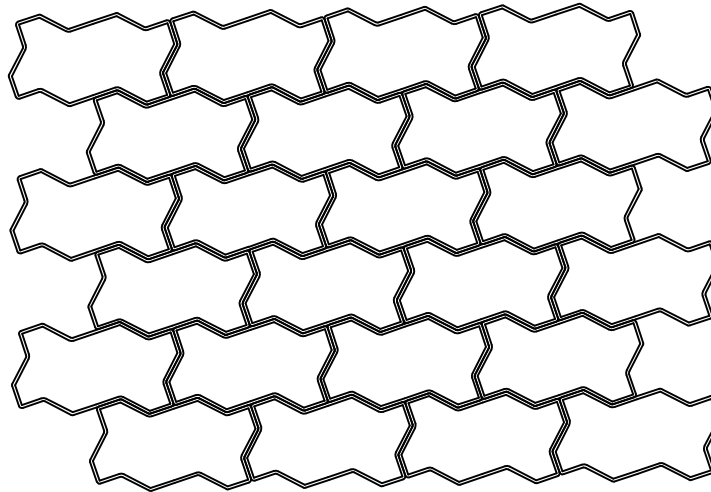

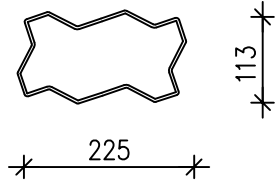

Menekki 40kpl/m<sup>2</sup>

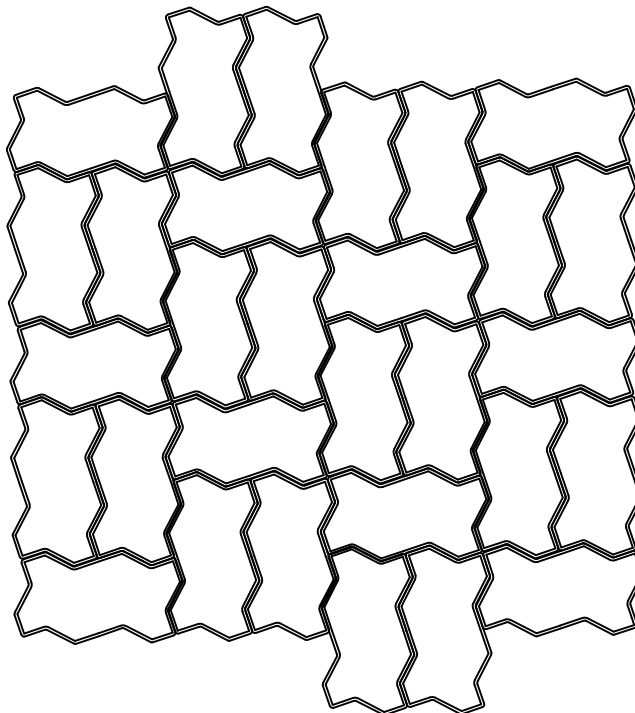
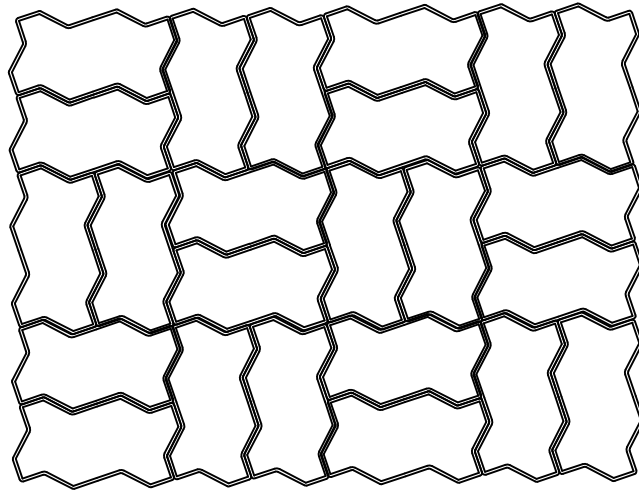

Menekki 18,5 kpl/m<sup>2</sup>

ANTIIKKIMUURIKIVI LOHKO  
CITYMUURIKIVI LOHKO/SILEÄ

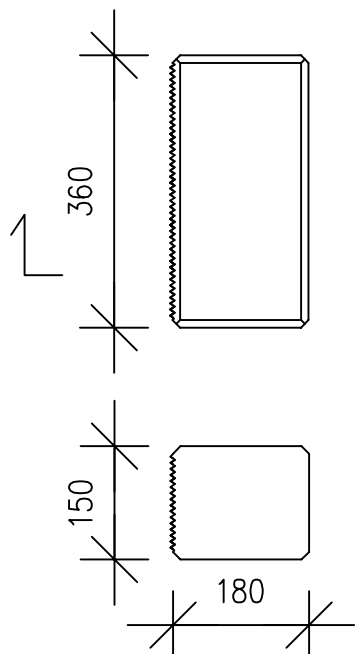

ANTIIKKIMUURIKIVI SILEÄ

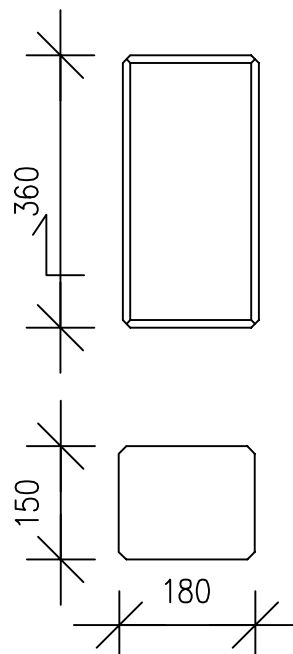

MUURIKIVET SOVELTUVAT MUUREIHIN,  
JOIDEN SUOSITELTAVA ENIMMÄISKORKEUS ON 750mm.  
TARVITTAESSA KIVET VOIDAAN LIIMATA TOISIINSA  
SÄÄNKESTÄVÄLLÄ SANEERAUSLAASTILLA TAI KIVILIIMALLA.

ANTIIKKIMUURIKIVI LOHKO, PUOLIKAS  
CITYMUURIKIVI PUOLIKAS

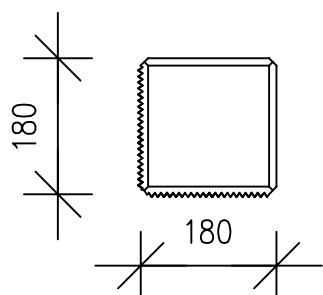

ANTIIKKIMUURIKIVI LOHKO KULMA  
CITYMUURIKIVI KULMA

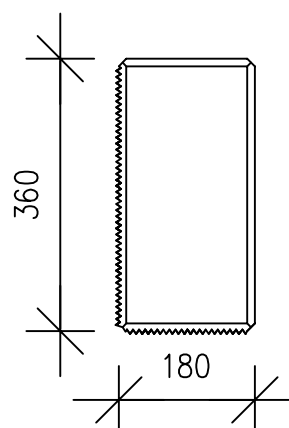

## MUURI EDESTÄ PÄIN

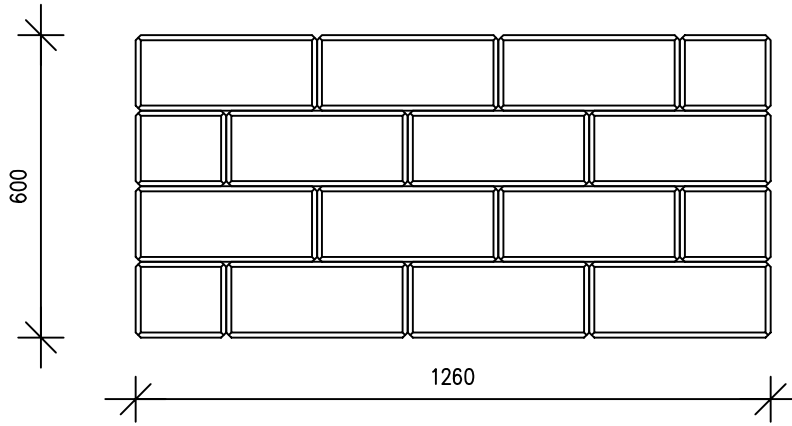

## 2. KIERROS

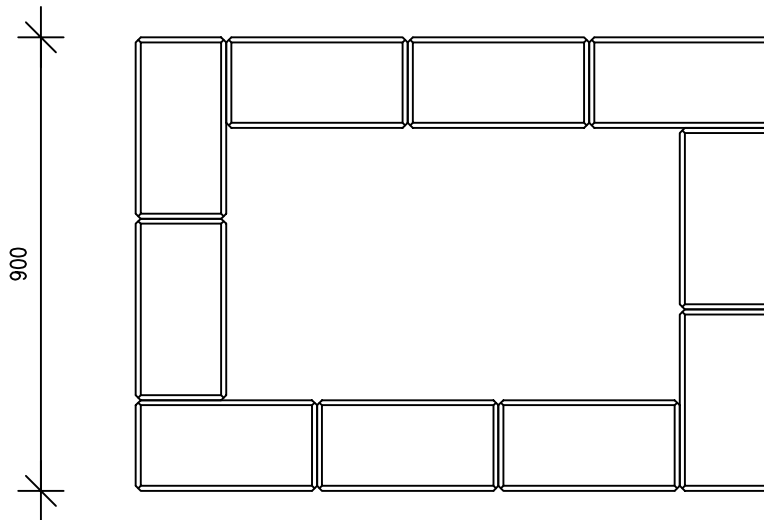

## 1. KIERROS

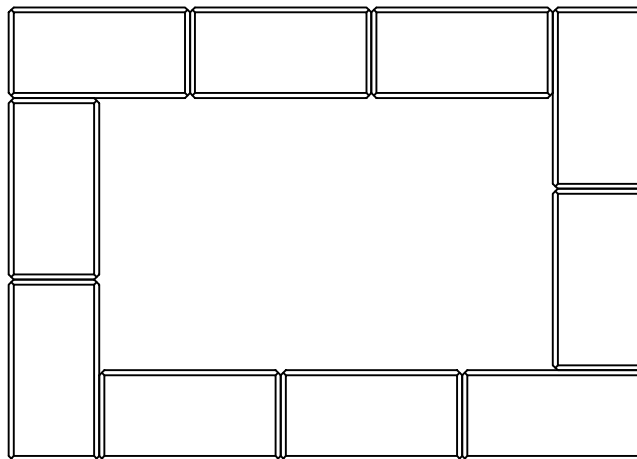

## MUURI EDESTÄ PÄIN

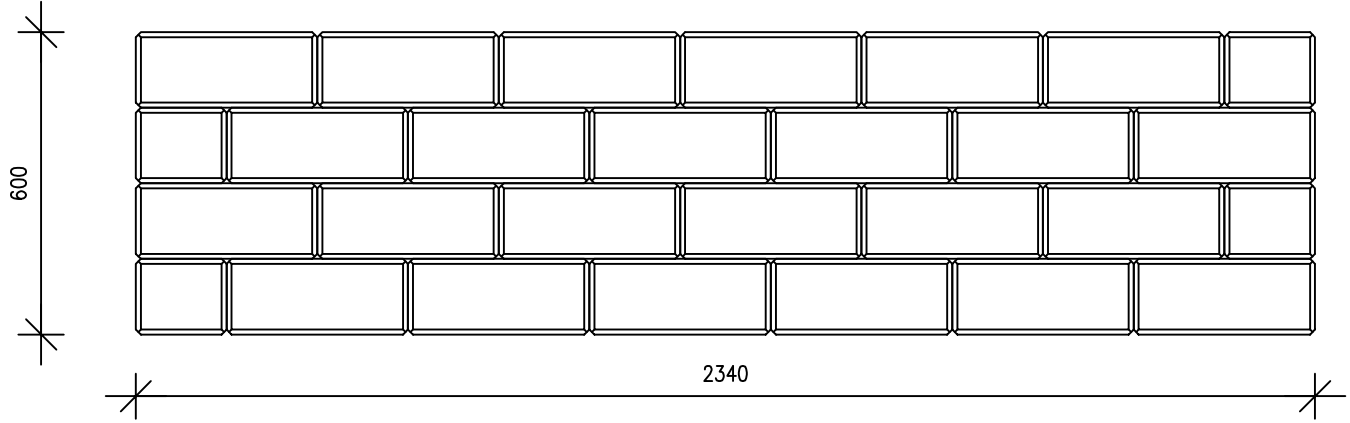

## 2. KIERROS

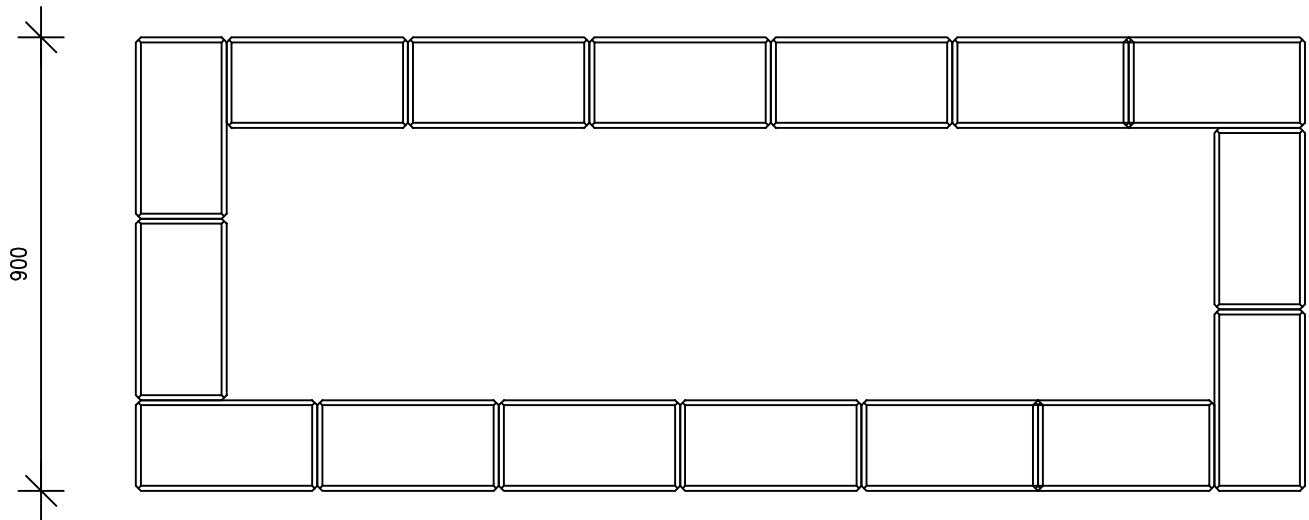

## 1. KIERROS

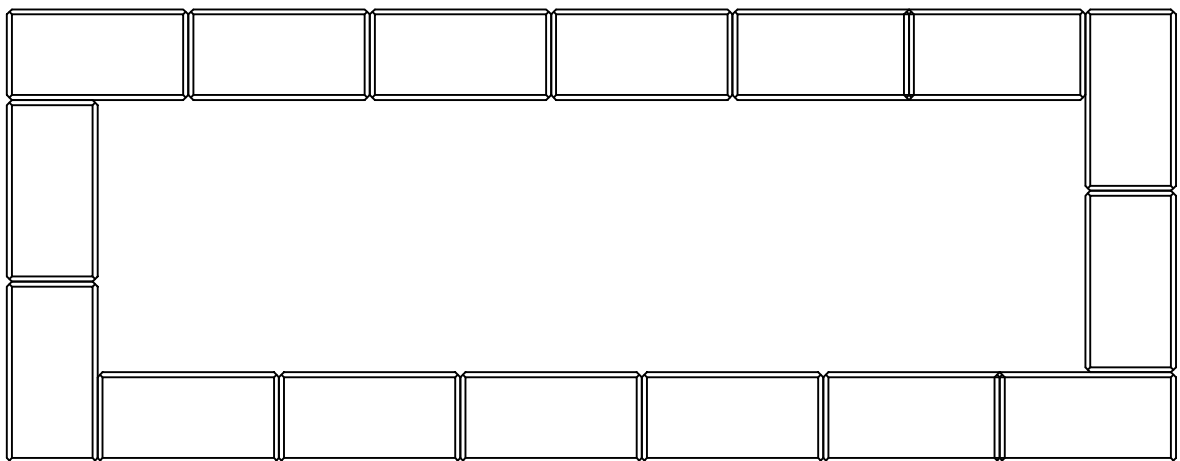

LOHKOKANSIKIVI

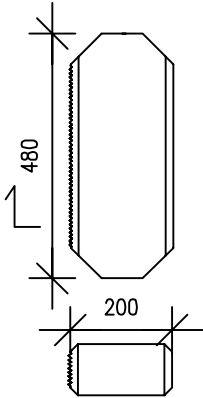

LOHKOMUURIKIVI

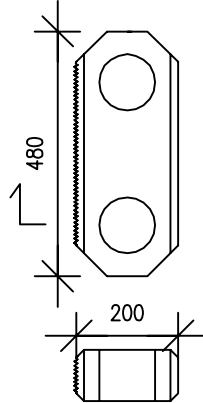

LOHKOMUURIKIVIPARI  
Menekki 17,8 kiviparia/m<sup>2</sup>

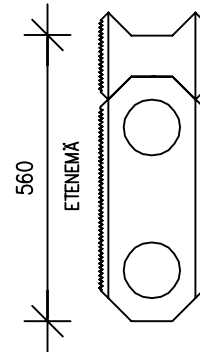

PÄÄTYKIVI "MUTTERI"

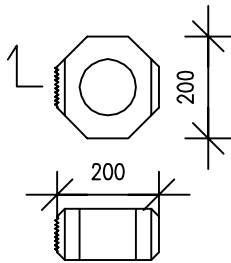

VÄLIKIVI "PERHONEN"

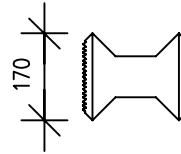

LOHKOMUURIKIVI- JA PÄÄTYKIVIPARI

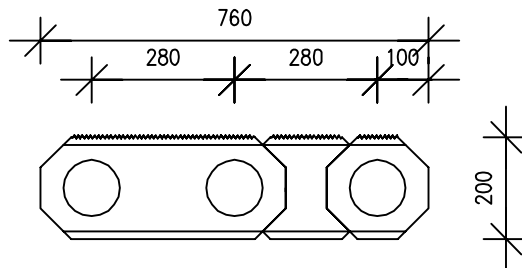

LOHKOMUURIKIVI ON VALMIIKSI LOHKAISTU.

KIVEN TOINEN PUOLI ON SILEÄ, JOLLOIN KUMPIKIN PUOLI ON JULKISIVUKELPOINEN.

RAKENNE VOIDAAN RAUDOITTA PYSTYSUUNTAAN, JOLLOIN PYSTYREIÄT VALETAAN BETONILLA KORKEISSA SEINÄMISSÄ.

SUORAKULMA TEHDÄÄN  
LEIKKAAMALLA VÄLIKIVESTÄ  
YKSI SAKARA POIS

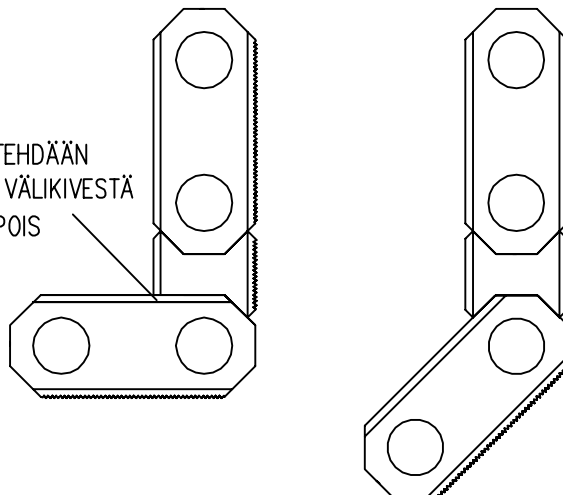

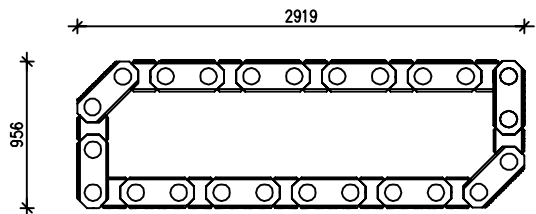
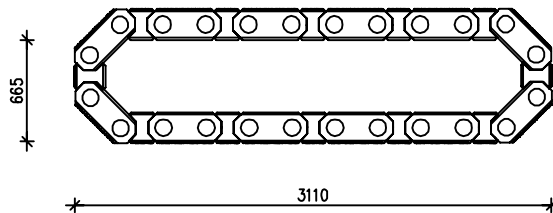
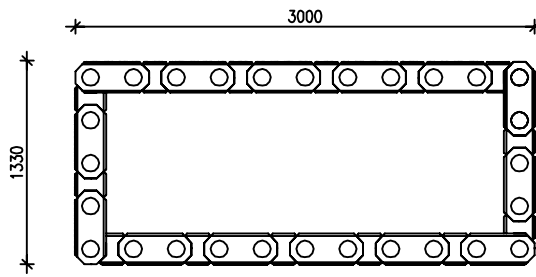
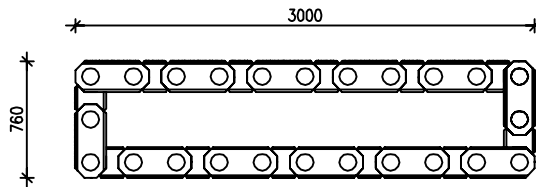



4 reikäkiparia

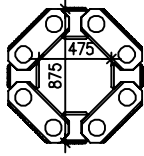

4 reikäkiparia

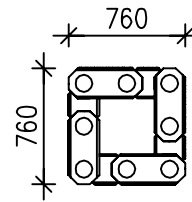

8 reikäkiparia

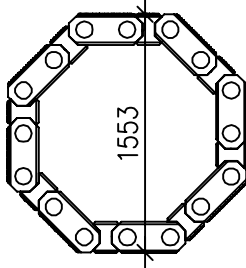

8 reikäkiparia

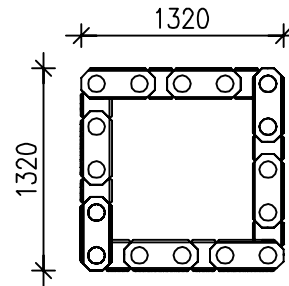

16 reikäkiparia

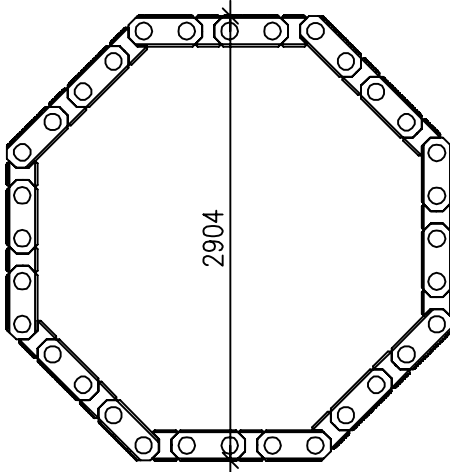

12 reikäkiparia

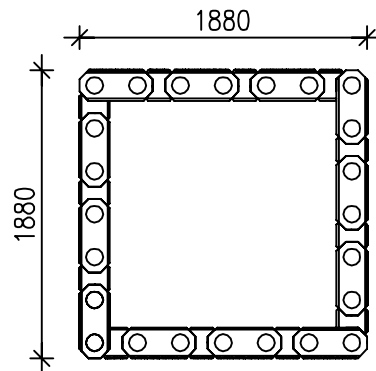

24 reikäkiparia

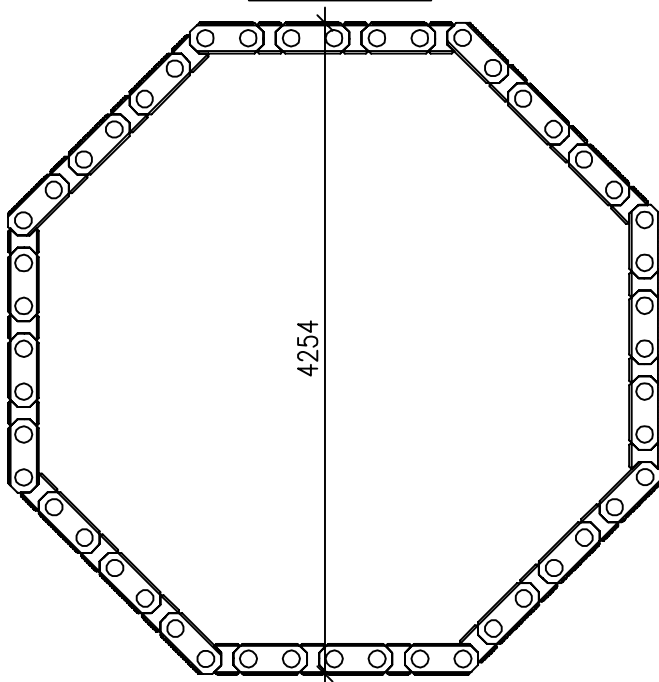

18 reikäkiparia

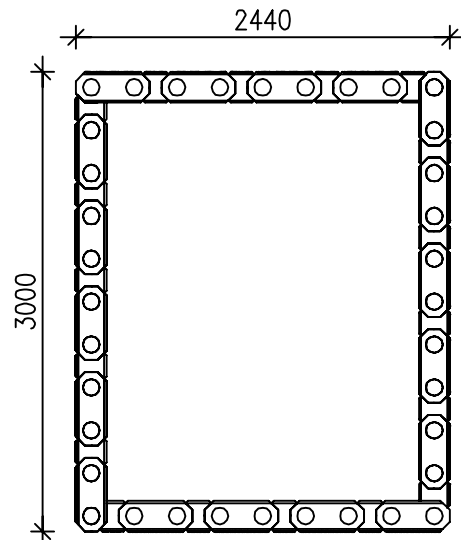

Menekki 21kpl/m<sup>2</sup> (halkaisemattomia kiviä)

SUORAREUNAINEN  
MUURIKIVI

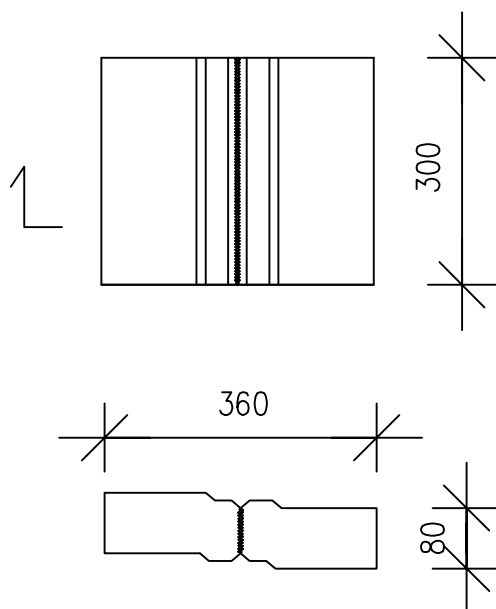

VINOREUNAINEN  
MUURIKIVI

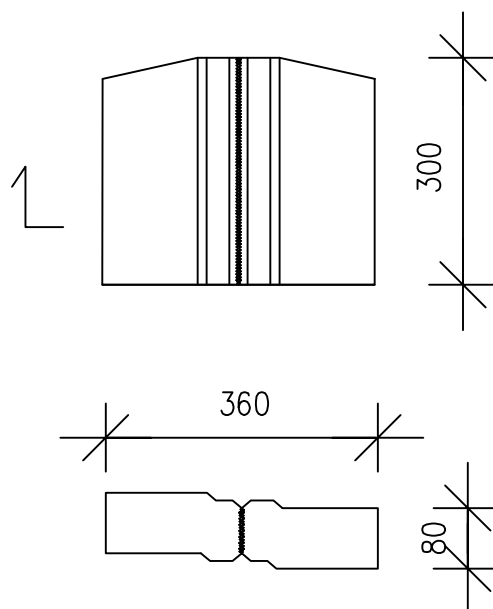

LAVALLA 16 SUORAREUNAISTA JA 24 VINOREUNAISTA KOKONAISTA KIVEÄ.  
MUURIKIVI TOIMITETAAN KOKONAISENA.  
KIVI HALKAISTAAN TYÖMAALLA, JOLLOIN SAADAAN KAKSI LOHKOPINTAISTA MUURIKIVEÄ.

MUURIKIVI PUOLIKAS

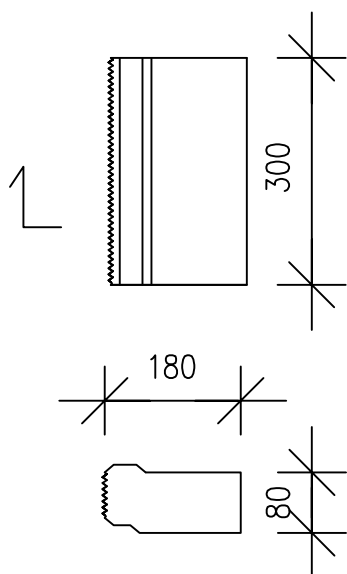

MUURIKIVIEN LADONTA

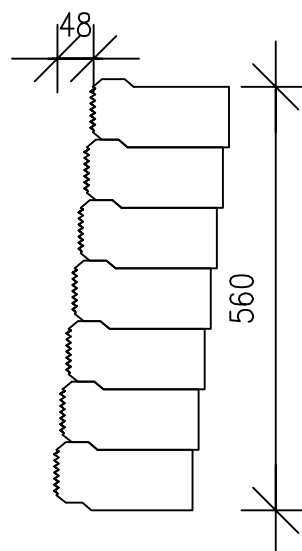

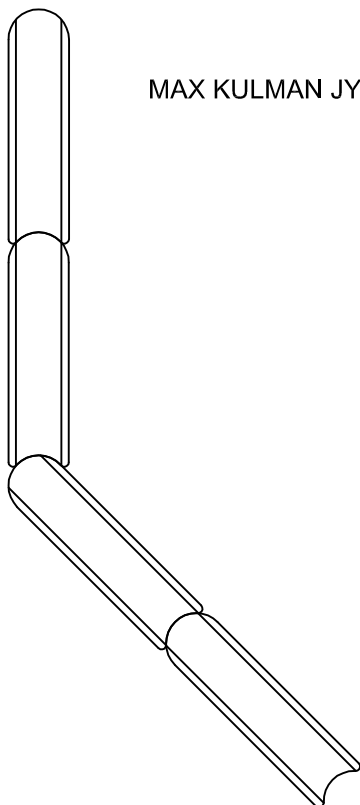
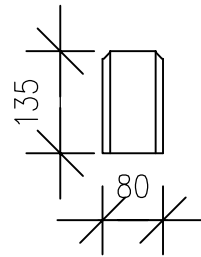
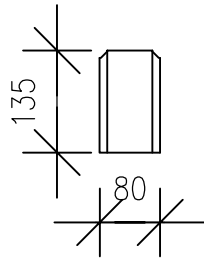
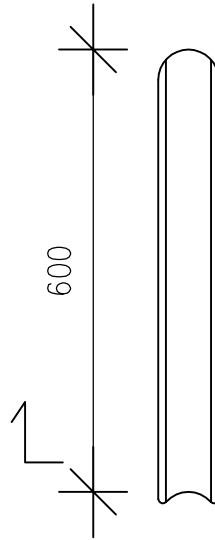
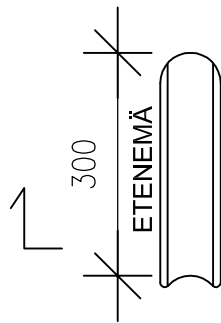

MAX KULMAN JYRKKYYS 45°

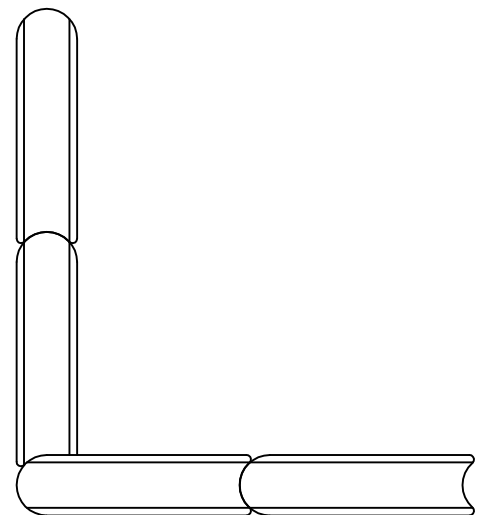

SUORAKULMA TEHDÄÄN LEIKKAAMALLA  
NURMIKON REUNAKIVESTÄ  
TOINEN SAKARA POIS

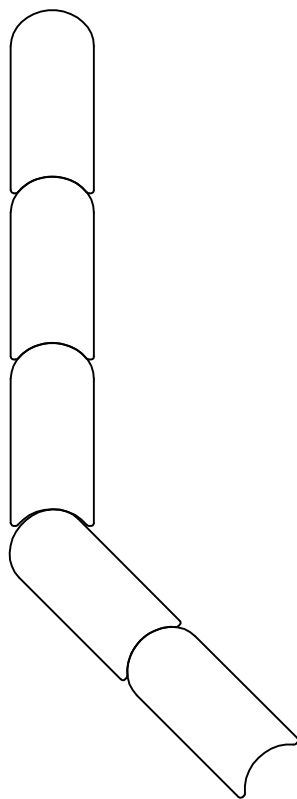
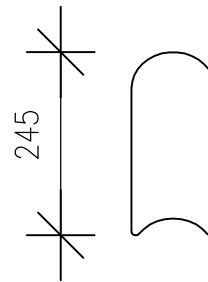
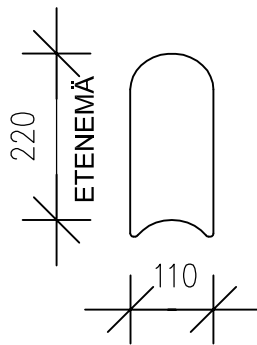

MAX KULMAN JYRKKYYS 45°

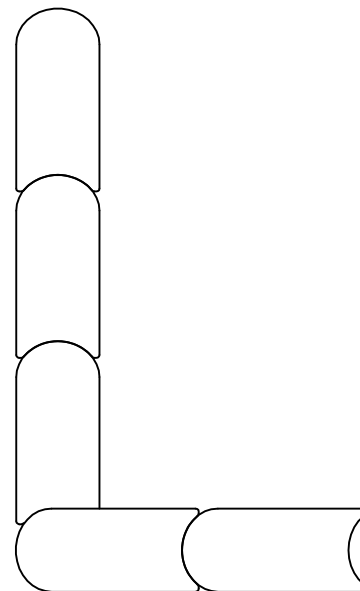

SUORAKULMA TEHDÄÄN  
LEIKKAAMALLA RASIKIVESTÄ  
TOINEN SAKARA POIS