

•lykke•

COMFORT (KSE-1021)

SUIHKUNURKKA | SHOWER CORNER
DUSCH HORN | DUSCHECKE

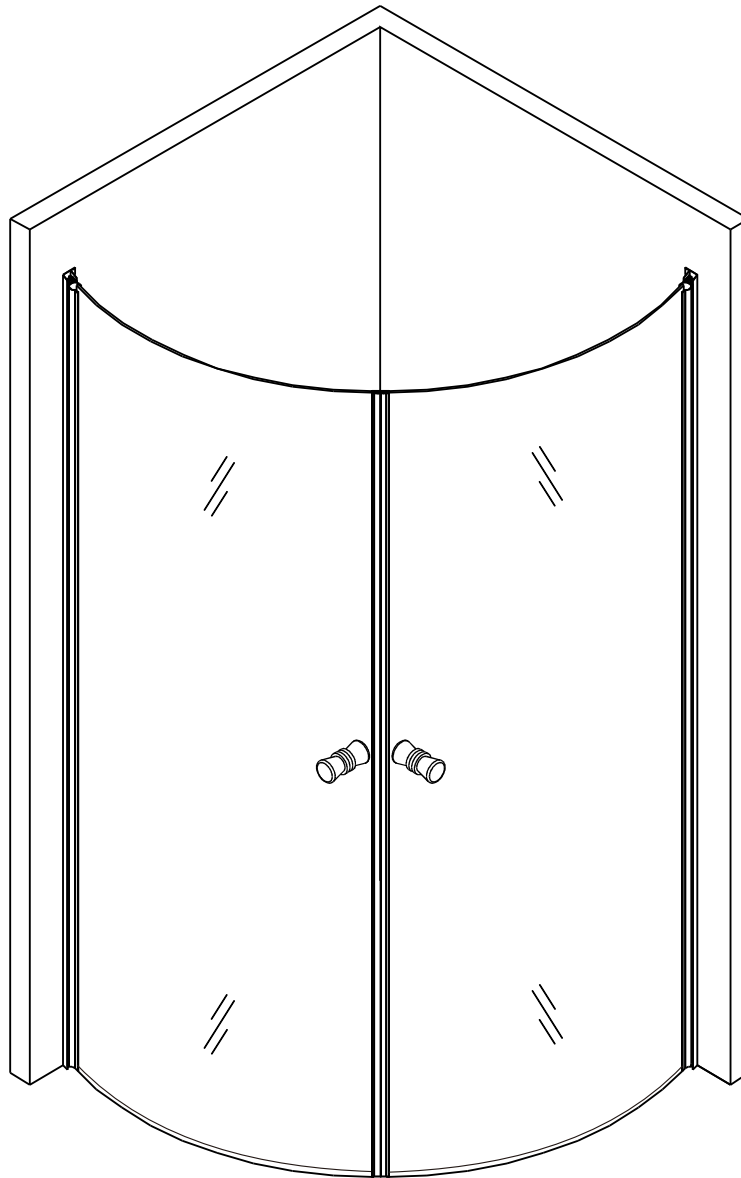

Maahantuoja / Importer / Importör / Importeur:

IP-Agency Finland Oy
Honkanummentie 13
01380 Vantaa Suomi
Finland

**ASENNUSTYÖKALUT / INSTALLATION TOOLS /
INSTALLATIONSVERKTYG / INSTALLATIONSWERKZEUGE**

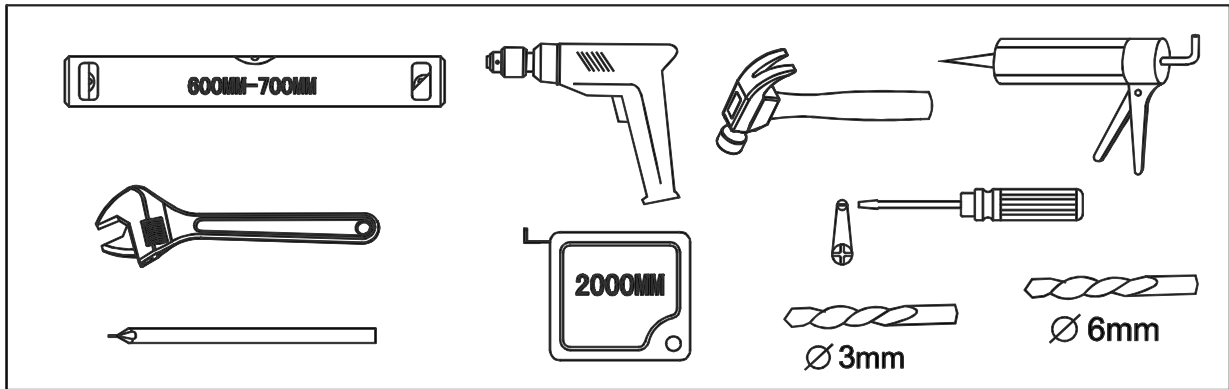

OSAT / COMPONENTS / KOMPONENTER / KOMPONENTEN

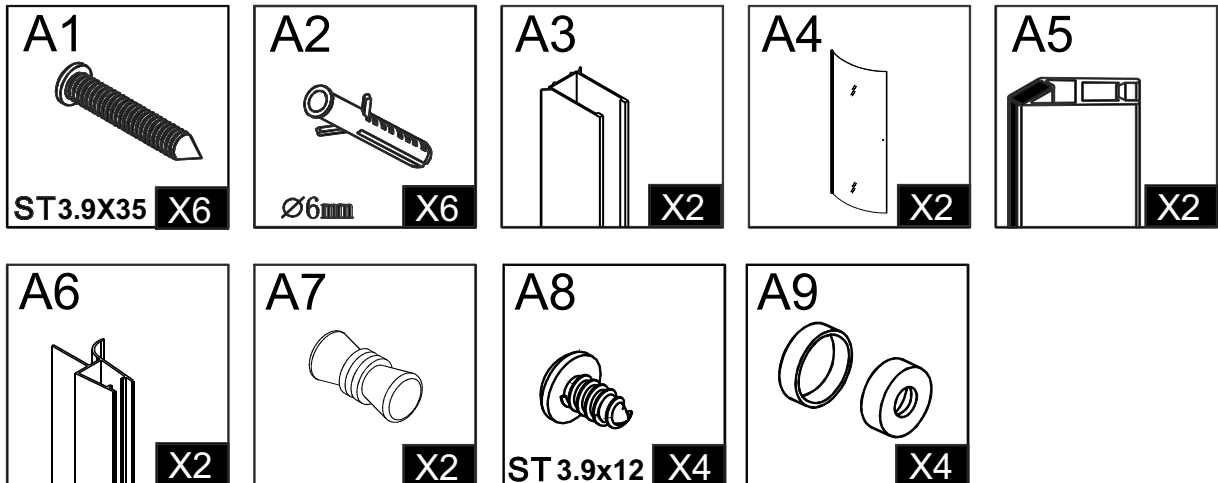

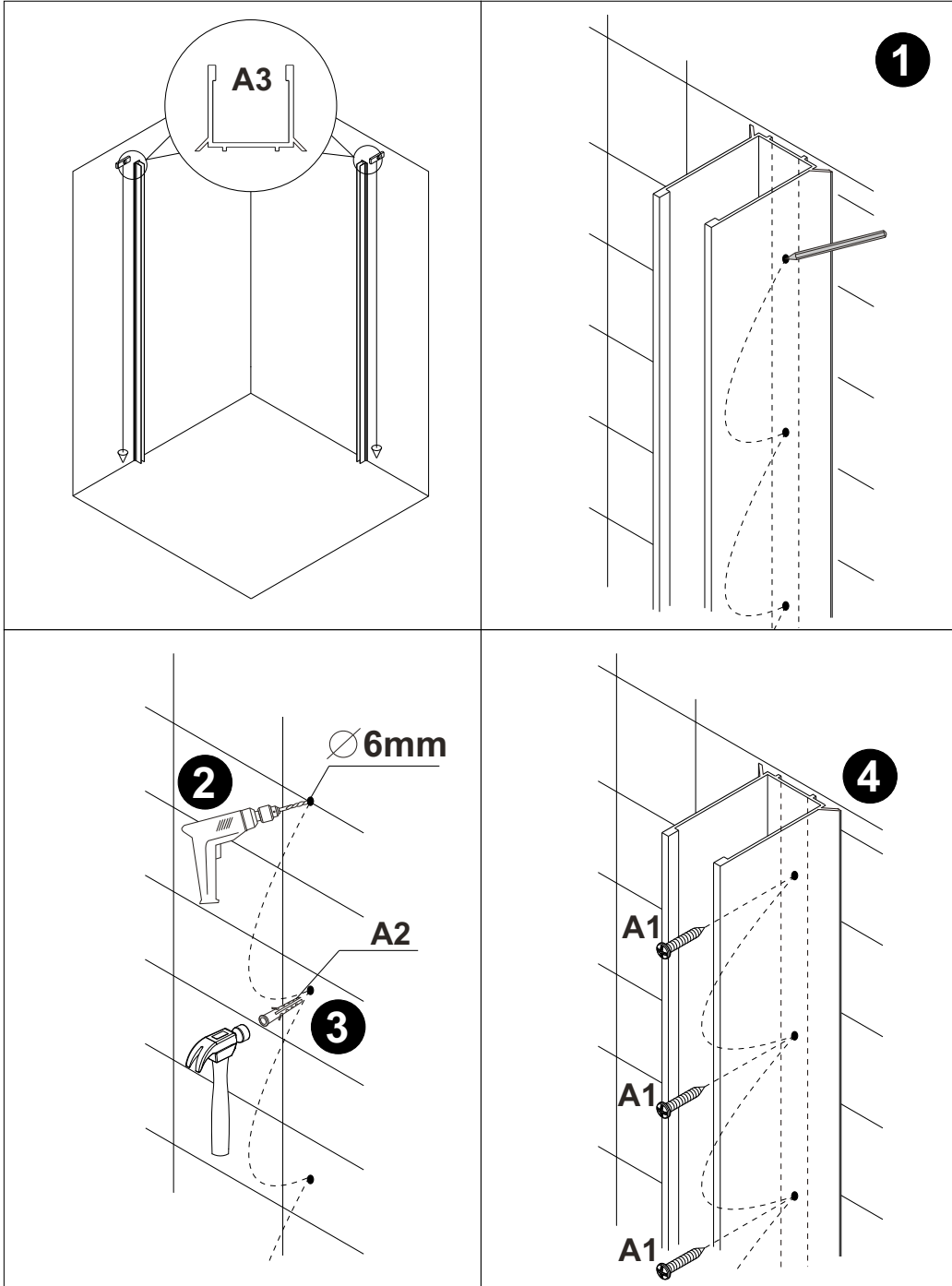
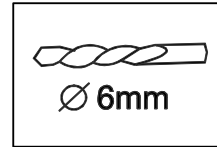
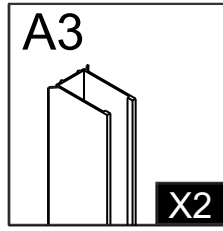
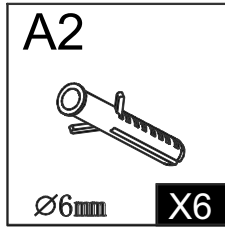
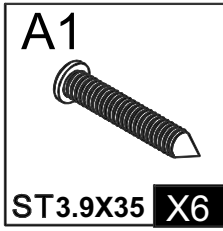

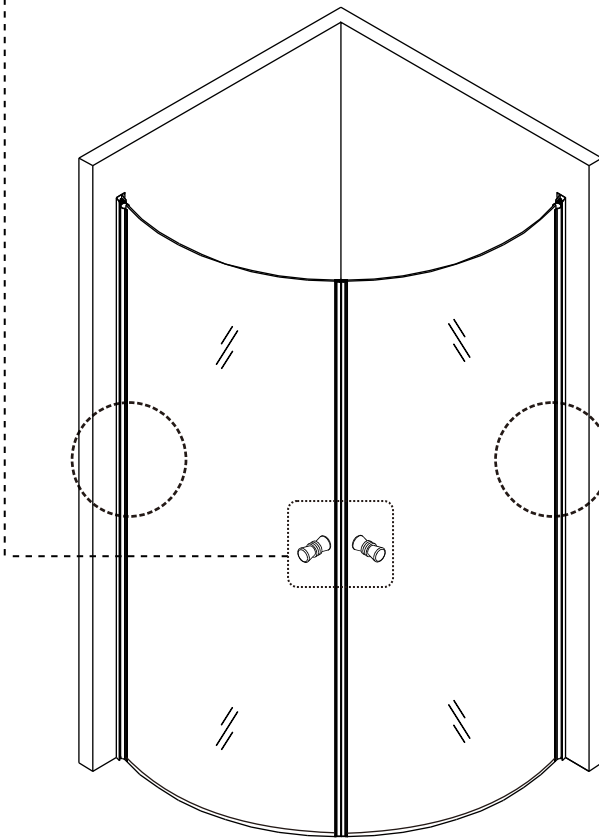
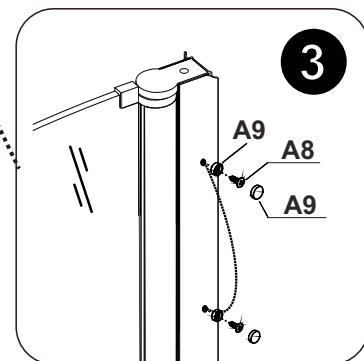
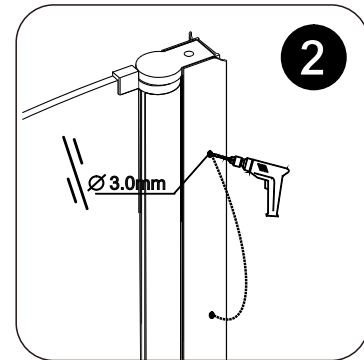
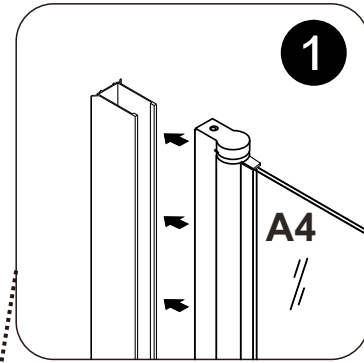
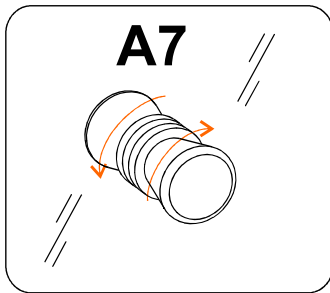
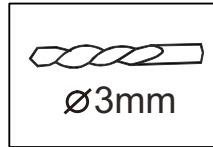
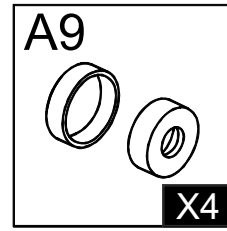
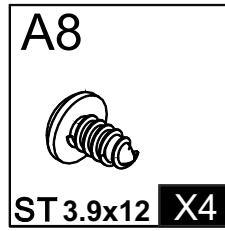
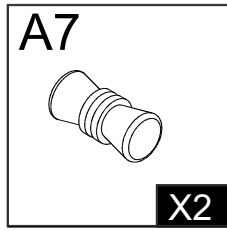
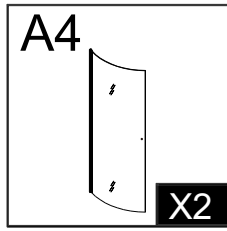

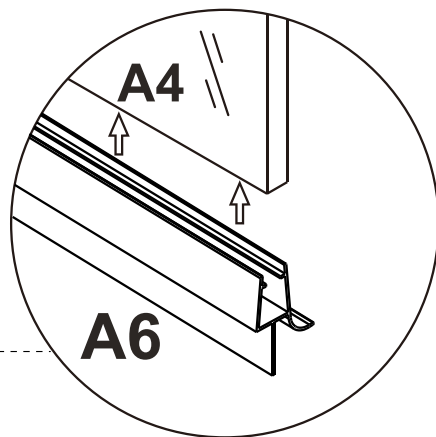
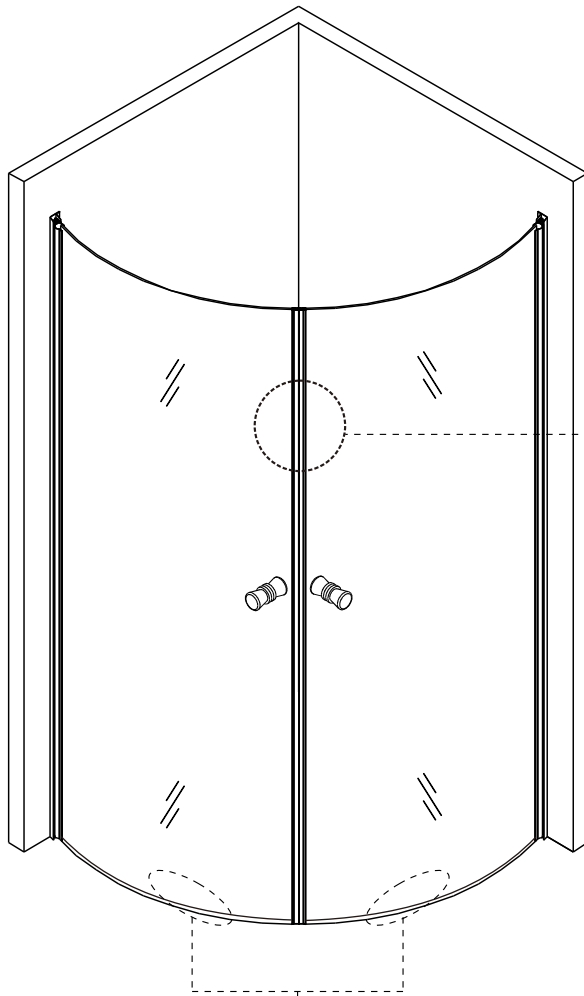
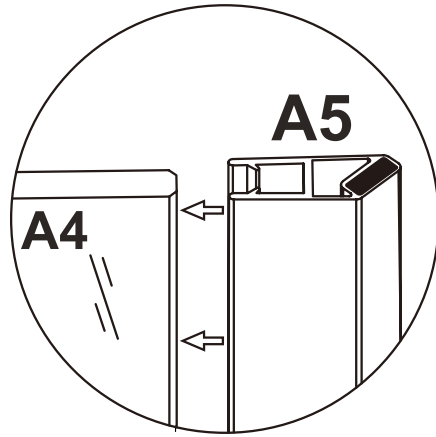
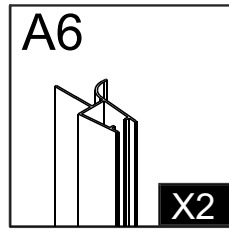
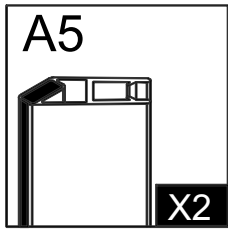

Tämä suomennettu käyttöohje on käännetty englannin kielestä. Pidätämme oikeudet mahdollisiin käännösvirheisiin. Käännös on tehty virallisen, englanninkielisen version pohjalta.

IP-Agency Finland Oy – Kaikki oikeudet pidätetään. Tuote ja käyttöohjeet voivat muuttua. Teknisiä tietoja voidaan muuttaa ilman erillistä ilmoitusta.

IP-Agency Finland Oy - All rights reserved. Product and instructions for use are subject to change. Technical information is subject to change without notice.

Denna svenska version av användarmanualen har översatts från engelska. Vi förbehåller oss rätten att göra eventuella fel i översättningen. Översättningen baseras på den officiella engelska versionen.

IP-Agency Finland Oy - Alla rättigheter förbehållna. Produkt och bruksanvisning kan komma att ändras. Teknisk information kan ändras utan föregående meddelande.

Diese deutsche Version der Bedienungsanleitung wurde aus dem Englischen übersetzt. Fehler in der Übersetzung sind vorbehalten. Die Übersetzung basiert auf der offiziellen englischen Version.

IP-Agency Finland Oy - Alle Rechte vorbehalten. Änderungen am Produkt und an der Gebrauchsanweisung sind vorbehalten. Technische Informationen können ohne vorherige Ankündigung geändert werden.

Standardin EN 14428:2005 + A1:2008 mukainen

Complies with EN 14428:2005 + A1:2008

Uppfyller kraven i EN 14428:2005 + A1:2008

Entspricht der Norm EN 14428:2005 + A1:2008

