

# Service Manual

## Air-to-Water Heatpump

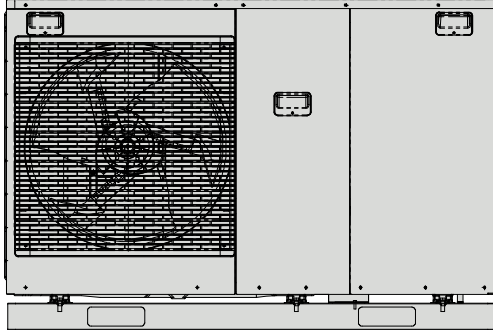

**Mono Bloc Unit**  
**WH-MDC05J3E5**  
**WH-MDC07J3E5**  
**WH-MDC09J3E5**

**Destination**  
**Europe**  
**Turkey**

### **WARNING**

This service information is designed for experienced repair technicians only and is not designed for use by the general public. It does not contain warnings or cautions to advise non-technical individuals of potential dangers in attempting to service a product. Products powered by electricity should be serviced or repaired only by experienced professional technicians. Any attempt to service or repair the products dealt with in this service information by anyone else could result in serious injury or death.

### **CAUTION**

**R32 REFRIGERANT** – This Air Conditioner contains and operates with refrigerant R32.  
**THIS PRODUCT MUST ONLY BE INSTALLED OR SERVICED BY QUALIFIED PERSONNEL.**  
Refer to National, State, Territory and local legislation, regulations, codes, installation & operation manuals, before the installation, maintenance and/or service of this product.

### **PRECAUTION OF LOW TEMPERATURE**

In order to avoid frostbite, be assured of no refrigerant leakage during the installation or repairing of refrigerant circuit.



# TABLE OF CONTENTS

	PAGE		PAGE
<b>1. Safety Precautions</b> .....	<b>4</b>	13.8 <Reference> Analysis method for no error code, no cooling / no warming .....	104
<b>2. Precaution for Using R32 Refrigerant</b> .....	<b>6</b>	<b>14. Operation and Control</b> .....	<b>106</b>
<b>3. Specifications</b> .....	<b>10</b>	14.1 Basic Function .....	106
3.1 WH-MDC05J3E5 .....	10	14.2 Water Pump .....	116
3.2 WH-MDC07J3E5 .....	13	14.3 Indoor Unit Safety .....	119
3.3 WH-MDC09J3E5 .....	16	14.4 Auto Restart Control .....	119
<b>4. Features</b> .....	<b>19</b>	14.5 Indication Panel .....	119
<b>5. Location of Controls and Components</b> .....	<b>20</b>	14.6 Indoor Back-Up Heater Control .....	120
5.1 Indoor Unit .....	20	14.7 Tank Heater Control.....	121
<b>6. Dimensions</b> .....	<b>38</b>	14.8 Base Pan Heater Control (Optional).....	122
6.1 Mono Bloc Unit.....	38	14.9 Force Heater Mode .....	123
<b>7. Refrigeration and Water Cycle Diagram</b> .....	<b>39</b>	14.10 Powerful Operation .....	124
7.1 Standard System (Optional PCB not connected) .....	40	14.11 Quiet Operation.....	125
7.2 Advance System (Optional PCB connected) .....	40	14.12 Sterilization Mode .....	125
<b>8. Block Diagram</b> .....	<b>41</b>	14.13 Outdoor Ambient Thermo OFF Control ....	126
8.1 WH-MDC05J3E5 .....	41	14.14 Alternative Outdoor Ambient Sensor Control .....	126
8.2 WH-MDC07J3E5 WH-MDC09J3E5.....	42	14.15 Force DHW mode .....	127
<b>9. Wiring Connection Diagram</b> .....	<b>43</b>	14.16 SMART DHW mode.....	127
9.1 Water System .....	43	14.17 DHW Capacity Setting .....	128
9.2 Refrigerant System .....	44	14.18 Anti Freeze Control .....	128
<b>10. Electronic Circuit Diagram</b> .....	<b>46</b>	14.19 Solar Operation (Optional).....	129
10.1 Water System .....	46	14.20 Boiler Bivalent Control .....	131
10.2 Refrigerant System .....	47	14.21 External Room Thermostat Control (Optional) .....	133
<b>11. Printed Circuit Board</b> .....	<b>49</b>	14.22 Three Ways Valve Control.....	134
11.1 Water System .....	49	14.23 Two Ways Valve Control.....	134
11.2 Refrigerant System .....	51	14.24 External OFF/ON Control .....	135
<b>12. Installation Instruction</b> .....	<b>52</b>	14.25 External Compressor Switch (Optional PCB).....	136
12.1 Mono Bloc Unit.....	52	14.26 Heat/Cool Switch (Optional PCB).....	137
12.2 Variation of system .....	64	14.27 SG Ready Control (Optional PCB) .....	137
12.3 How to Fix External Device.....	71	14.28 Demand Control (Optional PCB) .....	139
12.4 System Installation.....	74	14.29 Holiday Mode .....	139
12.5 Service and maintenance .....	85	14.30 Dry Concrete .....	140
<b>13. Installation and Servicing Air Conditioner using R32</b> .....	<b>86</b>	14.31 Flow Sensor .....	140
13.1 About R32 Refrigerant .....	86	<b>15. Protection Control (WH-MDC05J3E5).....</b>	<b>141</b>
13.2 Characteristics of R32 Refrigerant.....	86	15.1 Protection Control for All Operations .....	141
13.3 Refrigerant piping installation • Tools used in services .....	88	15.2 Protection Control for Heating Operation .....	143
13.4 New installation, Relocation, Repairing of Refrigerant Cycle System The Procedures .....	92	15.3 Protection Control for Cooling Operation .....	144
13.5 Piping installation of R32 .....	93	<b>16. Protection Control (WH-MDC07J3E5 WH-MDC09J3E5) .....</b>	<b>145</b>
13.6 Installation, Relocation, and Service.....	94	16.1 Protection Control for All Operations .....	145
13.7 Repairing of refrigerant cycle / Brazeing point.....	98	16.2 Protection Control for Heating Operation .....	147
		16.3 Protection Control for Cooling Operation .....	148
		<b>17. Servicing Mode</b> .....	<b>149</b>
		17.1 Expansion Vessel Pre Pressure Checking .....	149
		17.2 Maintenance .....	149
		17.3 Pump Down Procedures .....	150
		17.4 How To Adjust Pump Speed.....	151



17.5	How To Adjust Pump Speed .....	152
17.6	How To Unlock Cool Mode.....	153
17.7	EEPROM Factory Default Data Setup Procedure .....	154
17.8	Dry Concrete Setup .....	155
<b>18.</b>	<b>Maintenance Guide .....</b>	<b>157</b>
18.1	Maintenance Menu .....	158
<b>19.</b>	<b>Troubleshooting Guide.....</b>	<b>160</b>
19.1	Refrigeration Cycle System .....	160
19.2	Relationship between the Condition of the Air-to-Water Heatpump Indoor and Outdoor Units and Pressure and Electric Current.....	161
19.3	Breakdown Self Diagnosis Function.....	162
19.4	Error Codes Table .....	164
19.5	Self-diagnosis Method .....	166
<b>20.</b>	<b>Disassembly and Assembly Instructions ....</b>	<b>214</b>
20.1	To Remove The Cabinet Front Plate.....	214
20.2	To Remove The Cabinet Top Plate .....	214
20.3	To Remove The Cabinet Rear Plate .....	215
20.4	To Remove Pressure Gauge.....	215
20.5	To Remove RCCB.....	216
20.6	To Remove Reactor .....	216
20.7	To Remove Water System Electronic Controller Board.....	217
20.8	To Remove Refrigerant Side Control Board Complete.....	218
20.9	To Remove Pressure Relief Valve and Air Purge Valve .....	219
20.10	To Remove Flow Sensor .....	219
20.11	To Remove Water Pump .....	220
20.12	To Remove Heater .....	221
20.13	To Remove Filter .....	222
<b>21.</b>	<b>Technical Data .....</b>	<b>223</b>
21.1	Operation Characteristics .....	223
21.2	Heating Capacity Table .....	235
21.3	Cooling Capacity Table .....	236
<b>22.</b>	<b>Exploded View and Replacement Parts List .....</b>	<b>237</b>
22.1	Water System .....	237
22.2	Refrigerant System.....	238

# 1. Safety Precautions

























- Read the following “SAFETY PRECAUTIONS” carefully before installation of (Mono bloc) Air-to-Water Heatpump system (hereafter referred to as “Mono bloc unit”).
- Electrical works and water installation works must be done by licensed electrician and licensed water system installer respectively. Be sure to use the correct rating and main circuit for the model to be installed.
- The caution items stated here must be followed because these important contents are related to safety. The meaning of each indication used is as below.  
Incorrect installation due to ignorance or negligence of the instructions will cause harm or damage, and the seriousness is classified by the following indications.

 <b>WARNING</b>	This indication shows the possibility of causing death or serious injury.
 <b>CAUTION</b>	This indication shows the possibility of causing injury or damage to properties only.





The items to be followed are classified by the symbols:

	Symbol with white background denotes item that is PROHIBITED from doing.
	Symbol with dark background denotes item that must be carried out.













- Carry out test run to confirm that no abnormality occurs after the installation. Then, explain to user the operation, care and maintenance as stated in instructions. Please remind the customer to keep the operating instructions for future reference.
- If there is any doubt about the installation procedure or operation, always contact the authorized dealer for advice and information.

 <b>WARNING</b>	
1. Do not install Mono bloc unit near handrail of veranda. When installing Mono bloc unit at veranda of high rise building, child may climb up to Mono bloc unit and cross over the handrail and causing accident.	
2. Do not use unspecified cord, modified cord, join cord or extension cord for power supply cord. Do not share the single outlet with other electrical appliances. Poor contact, poor insulation or over current will cause electrical shock or fire.	
3. Do not tie up the power supply cord into a bundle by band. Abnormal temperature rise on power supply cord may happen.	
4. Do not insert your fingers or other objects into the unit, high speed rotating fan may cause injury. 	
5. Do not sit or step on the unit, you may fall down accidentally. 	
6. Keep plastic bag (packaging material) away from small children, it may cause suffocation.	
7. Do not use pipe wrench to install refrigerant pipe. It might deform the piping and cause the unit to malfunction.	
8. Do not purchase unauthorized electrical parts for installation, service, maintenance and etc.. They might cause electrical shock or fire.	
9. This unit is a multi supply appliances. All circuits must be disconnected before accessing to the unit terminals.	
10. Do not modify the wiring of Mono bloc unit for installation of other components (i.e. heater, etc). Overloaded wiring or wire connection points may cause electrical shock or fire.	
11. Do not add or replace refrigerant other than specified type. It may cause product damage, burst and injury etc.	
12. For electrical work, follow the local national wiring standard, regulation and this installation instruction. An independent circuit and single outlet must be used. If electrical circuit capacity is not enough or defect found in electrical work, it will cause electrical shock or fire.	
13. For water circuit installation work, follow to relevant European and national regulations (including EN61770) and local plumbing and building regulation codes.	
14. Must engage an authorized dealer or specialist for installation. If installation is defective, it will cause water leakage, electrical shock or fire.	
15. Install according to this installation instructions strictly. If installation is defective, it will cause water leakage, electrical shock or fire.	
16. Only use the supplied or specified installation parts. Else, it may causes Mono bloc unit vibrate, fall, water leakage, electrical shock or fire.	
17. Install at a flat, strong and firm location which is able to withstand the Mono bloc unit's weight. If the location is slanting, or strength is not enough the set will fall and cause injury.	
18. This equipment is strongly recommended to be installed with Residual Current Device (RCD) on-site according to the respective national wiring rules or country-specific safety measures in terms of residual current.	
19. The unit is only for use in a closed water system. Utilization in an open water system may lead to excessive corrosion of the water piping and risk of incubating bacteria colonies, particularly Legionella, in water.	
20. If there is any doubt about the installation procedure or operation, always contact the authorized dealer for advice and information.	
21. Select a location where in case of water leakage, the leakage will not cause damage to other properties.	

 **WARNING**

22.	When installing electrical equipment at wooden building of metal lath or wire lath, in accordance with electrical facility standard, no electrical contact between equipment and building is allowed. Insulator must be installed in between.	
23.	This installation may be subjected to building regulation approval applicable to respective country that may require to notify the local authority before installation.	
24.	Any work carried out on the Mono bloc unit after removing the front panel which is secured by screws, must be carried out under the supervision of authorized dealer and licensed installation contractor.	
25.	This unit must be properly earthed, the electrical earth must not be connected to a gas pipe, water pipe, the earth of a lightning rod or a telephone. Otherwise there is a danger of electrical shock in the event of an insulation breakdown or electrical earth fault in the Mono bloc unit.	

 **CAUTION**

1.	Do not install the Mono bloc unit in areas where there is a risk of flammable gas leakage. There is a risk of fire if flammable gas accumulates near or around the Mono bloc unit.	
2.	Do not release refrigerant during piping work for installation, re-installation and during repairing a refrigeration parts. Take care of the liquid refrigerant, it may cause frostbite.	
3.	Make sure the power supply cord does not contact with hot part (i.e. water piping). High temperature may cause insulator of power supply cord damage hence electrical shock or fire.	
4.	Do not touch the sharp aluminium fin, sharp parts may cause injury. 	
5.	Do not apply excessive force to water pipes that may damage the pipes. If water leakage occurs, it will cause flooding and damage to other properties.	
6.	Carry out drainage piping as mentioned in installation instructions. If drainage is not perfect, water leakage may happen and may cause damage to properties of the user.	
7.	The piping installation work must be flushed before the Mono bloc unit is connected to remove contaminants. Contaminants may damage the Mono bloc unit components.	
8.	Select an installation location where it is accessible for maintenance.	
9.	<p>Power supply connection to Mono bloc unit.</p> <ul style="list-style-type: none"> <li>• Power supply point should be in easily accessible place for power disconnection in case of emergency.</li> <li>• Must follow local national wiring standard, regulation and this installation instruction.</li> <li>• Strongly recommended to make permanent connection to a circuit breaker. It must be a double pole switch with a minimum 3.0 mm gap.               <ul style="list-style-type: none"> <li>- Power supply 1: Use approved 30A circuit breaker</li> <li>- Power supply 2: Use approved 30A circuit breaker</li> </ul> </li> </ul>	
10.	Ensure the correct polarity is maintained throughout all wiring. Otherwise, it will cause electrical shock or fire.	
11.	After installation, the installer is obliged to verify correct operation of the Mono bloc unit. Check the connection point for water leakage during test run. If leakage occurs, it will cause damage to other properties.	
12.	<p>Installation work.</p> <p>Four or more people are required to carry out the installation work. The weight of Mono bloc unit might cause injury if carried by less than four people.</p>	

## 2. Precaution for Using R32 Refrigerant

- The basic installation work procedures are the same as conventional refrigerant (R410A, R22) models. However, pay careful attention to the following points:

 <b>WARNING</b>	
1.	Since the working pressure is higher than that of refrigerant R22 models, some of the piping and installation and service tools are special. Especially, when replacing a refrigerant R22 model with a new refrigerant R32 model, always replace the conventional piping with the R32 and R410A piping on the outdoor unit side. For R32 and R410A, the same pipe can be used.
2.	The mixing of different refrigerants within a system is prohibited. Models that use refrigerant R32 and R410A have a different charging port thread diameter to prevent erroneous charging with refrigerant R22 and for safety. Therefore, check beforehand. [The charging port thread diameter for R32 and R410A is 12.7 mm (1/2 inch).]
3.	Ensure that foreign matter (oil, water, etc.) does not enter the piping.
4.	Operation, maintenance, repairing and refrigerant recovery should be carried out by trained and certified personnel in the use of flammable refrigerants and as recommended by the manufacturer. Any personnel conducting an operation, servicing or maintenance on a system or associated parts of the equipment should be trained and certified.
5.	Any part of refrigerating circuit (evaporators, air coolers, AHU, condensers or liquid receivers) or piping should not be located in the proximity of heat sources, open flames, operating gas appliance or an operating electric heater.
6.	The user/owner or their authorized representative shall regularly check the alarms, mechanical ventilation and detectors, at least once a year, where as required by national regulations, to ensure their correct functioning.
7.	A logbook shall be maintained. The results of these checks shall be recorded in the logbook.
8.	In case of ventilations in occupied spaces shall be checked to confirm no obstruction.
9.	Before a new refrigerating system is put into service, the person responsible for placing the system in operation should ensure that trained and certified operating personnel are instructed on the basis of the instruction manual about the construction, supervision, operation and maintenance of the refrigerating system, as well as the safety measures to be observed, and the properties and handling of the refrigerant used.
10.	The general requirement of trained and certified personnel are indicated as below: a) Knowledge of legislation, regulations and standards relating to flammable refrigerants; and, b) Detailed knowledge of and skills in handling flammable refrigerants, personal protective equipment, refrigerant leakage prevention, handling of cylinders, charging, leak detection, recovery and disposal; and, c) Able to understand and to apply in practice the requirements in the national legislation, regulations and Standards; and, d) Continuously undergo regular and further training to maintain this expertise.
11.	Protect the refrigerating system from accidental rupture due to moving furniture or reconstruction activities.
12.	To ensure no leaking, field-made refrigerant joints indoors shall be tightness tested. The test method shall have a sensitivity of 5 grams per year of refrigerant or better under a pressure of at least 0,25 times the maximum allowable pressure (>1.04MPa, max 4.15MPa). No leak shall be detected.

 **CAUTION**

Installation (Space)

1.
  - Must comply with national gas regulations, state municipal rules and legislation. Notify relevant authorities in accordance with all applicable regulations.
  - Must ensure mechanical connections be accessible for maintenance purposes.
  - In cases that require mechanical ventilation, ventilation openings shall be kept clear of obstruction.
  - When disposal of the product, do follow to the precautions in #12 and comply with national regulations.
  - Always contact to local municipal offices for proper handling.

Servicing

2-1. Service personnel

- Any qualified person who is involved with working on or breaking into a refrigerant circuit should hold a current valid certificate from an industry-accredited assessment authority, which authorizes their competence to handle refrigerants safely in accordance with an industry recognised assessment specification.
- Servicing shall only be performed as recommended by the equipment manufacturer. Maintenance and repair requiring the assistance of other skilled personnel shall be carried out under the supervision of the person competent in the use of flammable refrigerants.
- Servicing shall be performed only as recommended by the manufacturer.
- The system is inspected, regularly supervised and maintained by a trained and certified service personnel who is employed by the person user or party responsible.
- Ensure refrigerant charge not to leak.

2-2. Work

- Prior to beginning work on systems containing flammable refrigerants, safety checks are necessary to ensure that the risk of ignition is minimised.  
For repair to the refrigerating system, the precautions in #2-2 to #2-8 must be followed before conducting work on the system.
- Work shall be undertaken under a controlled procedure so as to minimize the risk of a flammable gas or vapor being present while the work is being performed.
- All maintenance staff and others working in the local area shall be instructed and supervised on the nature of work being carried out.
- Avoid working in confined spaces. Always ensure away from source, at least 2 meter of safety distance, or zoning of free space area of at least 2 meter in radius.
- Wear appropriate protective equipment, including respiratory protection, as conditions warrant.
- Keep all sources of ignition and hot metal surfaces away.

2-3. Checking for presence of refrigerant

- The area shall be checked with an appropriate refrigerant detector prior to and during work, to ensure the technician is aware of potentially flammable atmospheres.
- Ensure that the leak detection equipment being used is suitable for use with flammable refrigerants, i.e. non sparking, adequately sealed or intrinsically safe.
- In case of leakage/spillage happened, immediately ventilate area and stay upwind and away from spill/release.
- In case of leakage/spillage happened, do notify persons downwind of the leaking/spill, isolate immediate hazard area and keep unauthorized personnel out.

2-4. Presence of fire extinguisher

2.
  - If any hot work is to be conducted on the refrigeration equipment or any associated parts, appropriate fire extinguishing equipment shall be available at hand.
  - Have a dry powder or CO<sub>2</sub> fire extinguisher adjacent to the charging area.

2-5. No ignition sources

- No person carrying out work in relation to a refrigeration system which involves exposing any pipe work that contains or has contained flammable refrigerant shall use any sources of ignition in such a manner that it may lead to the risk of fire or explosion. He/She must not be smoking when carrying out such work.
- All possible ignition sources, including cigarette smoking, should be kept sufficiently far away from the site of installation, repairing, removing and disposal, during which flammable refrigerant can possibly be released to the surrounding space.
- Prior to work taking place, the area around the equipment is to be surveyed to make sure that there are no flammable hazards or ignition risks.
- "No Smoking" signs shall be displayed.

2-6. Ventilated area

- Ensure that the area is in the open or that it is adequately ventilated before breaking into the system or conducting any hot work.
- A degree of ventilation shall continue during the period that the work is carried out.
- The ventilation should safely disperse any released refrigerant and preferably expel it externally into the atmosphere.

2-7. Checks to the refrigeration equipment

- Where electrical components are being changed, they shall be fit for the purpose and to the correct specification.
- At all times the manufacturer's maintenance and service guidelines shall be followed.
- If in doubt consult the manufacturer's technical department for assistance.
- The following checks shall be applied to installations using flammable refrigerants.
  - The ventilation machinery and outlets are operating adequately and are not obstructed.
  - Marking to the equipment continues to be visible and legible. Markings and signs that are illegible shall be corrected.

2-8. Checks to electrical devices

- Repair and maintenance to electrical components shall include initial safety checks and component inspection procedures.
- Initial safety checks shall include but not limit to:-
  - That capacitors are discharged: this shall be done in a safe manner to avoid possibility of sparking.
  - That there is no live electrical components and wiring are exposed while charging, recovering or purging the system.
  - That there is continuity of earth bonding.
- At all times the manufacturer's maintenance and service guidelines shall be followed.
- If in doubt consult the manufacturer's technical department for assistance.
- If a fault exists that could compromise safety, then no electrical supply shall be connected to the circuit until it is satisfactorily dealt with.
- If the fault cannot be corrected immediately but it is necessary to continue operation, an adequate temporary solution shall be used.
- The owner of the equipment must be informed or reported so all parties are advised thereafter.

 CAUTION

Repairs to sealed components

- During repairs to sealed components, all electrical supplies shall be disconnected from the equipment being worked upon prior to any removal of sealed covers, etc.
  - If it is absolutely necessary to have an electrical supply to equipment during servicing, then a permanently operating form of leak detection shall be located at the most critical point to warn of a potentially hazardous situation.
  - Particular attention shall be paid to the following to ensure that by working on electrical components, the casing is not altered in such a way that the level of protection is affected. This shall include damage to cables, excessive number of connections, terminals not made to original specification, damage to seals, incorrect fitting of glands, etc.
- 3.
- Ensure that apparatus is mounted securely.
  - Ensure that seals or sealing materials have not degraded such that they no longer serve the purpose of preventing the ingress of flammable atmospheres.
  - Replacement parts shall be in accordance with the manufacturer's specifications.

NOTE: The use of silicon sealant may inhibit the effectiveness of some types of leak detection equipment. Intrinsically safe components do not have to be isolated prior to working on them.

Repair to intrinsically safe components

- Do not apply any permanent inductive or capacitance loads to the circuit without ensuring that this will not exceed the permissible voltage and current permitted for the equipment in use.
- 4.
- Intrinsically safe components are the only types that can be worked on while live in the presence of a flammable atmosphere.
  - The test apparatus shall be at the correct rating.
  - Replace components only with parts specified by the manufacturer. Unspecified parts by manufacturer may result ignition of refrigerant in the atmosphere from a leak.

Cabling

- 5.
- Check that cabling will not be subject to wear, corrosion, excessive pressure, vibration, sharp edges or any other adverse environmental effects.
  - The check shall also take into account the effects of aging or continual vibration from sources such as compressors or fans.

Detection of flammable refrigerants

- 6.
- Under no circumstances shall potential sources of ignition be used in the searching or detection of refrigerant leaks.
  - A halide torch (or any other detector using a naked flame) shall not be used.

The following leak detection methods are deemed acceptable for all refrigerant systems.

- No leaks shall be detected when using detection equipment with a sensitivity of 5 grams per year of refrigerant or better under a pressure of at least 0,25 times the maximum allowable pressure (>1.04MPa, max 4.15MPa). For example, a universal sniffer.
  - Electronic leak detectors may be used to detect flammable refrigerants, but the sensitivity may not be adequate, or may need recalibration.  
(Detection equipment shall be calibrated in a refrigerant-free area.)
- 7.
- Ensure that the detector is not a potential source of ignition and is suitable for the refrigerant used.
  - Leak detection equipment shall be set at a percentage of the LFL of the refrigerant and shall be calibrated to the refrigerant employed and the appropriate percentage of gas (25 % maximum) is confirmed.
  - Leak detection fluids are suitable for use with most refrigerants but the use of detergents containing chlorine shall be avoided as the chlorine may react with the refrigerant and corrode the copper pipe-work.
  - If a leak is suspected, all naked flames shall be removed/extinguished.
  - If a leakage of refrigerant is found which requires brazing, all of the refrigerant shall be recovered from the system, or isolated (by means of shut off valves) in a part of the system remote from the leak. The precautions in #8 must be followed to remove the refrigerant.

Removal and evacuation

- When breaking into the refrigerant circuit to make repairs – or for any other purpose – conventional procedures shall be used. However, it is important that best practice is followed since flammability is a consideration. The following procedure shall be adhered to:

- remove refrigerant -> • purge the circuit with inert gas -> • evacuate -> • purge again with inert gas -> • open the circuit by cutting or brazing

- 8.
- The refrigerant charge shall be recovered into the correct recovery cylinders.
  - The system shall be purged with OFN to render the appliances safe. (remark: OFN = oxygen free nitrogen, type of inert gas)
  - This process may need to be repeated several times.
  - Compressed air or oxygen shall not be used for this task.
  - Flushing shall be achieved by breaking the vacuum in the system with OFN and continuing to fill until the working pressure is achieved, then venting to atmosphere, and finally pulling down to a vacuum.
  - This process shall be repeated until no refrigerant is within the system.
  - When the final OFN charge is used, the system shall be vented down to atmospheric pressure to enable work to take place.
  - This operation is absolutely vital if brazing operations on the pipe work are to take place.
  - Ensure that the outlet for the vacuum pump is not close to any ignition sources and there is ventilation available.

Charging procedures

- In addition to conventional charging procedures, the following requirements shall be followed.
    - Ensure that contamination of different refrigerants does not occur when using charging equipment.
    - Hoses or lines shall be as short as possible to minimize the amount of refrigerant contained in them.
    - Cylinders shall be kept in an appropriate position according to the instructions.
    - Ensure that the refrigeration system is earthed prior to charging the system with refrigerant.
    - Label the system when charging is complete (if not already).
- 9.
- Extreme care shall be taken not to over fill the refrigeration system.
  - Prior to recharging the system it shall be pressure tested with OFN (refer to #7).
  - The system shall be leak tested on completion of charging but prior to commissioning.
  - A follow up leak test shall be carried out prior to leaving the site.
  - Electrostatic charge may accumulate and create a hazardous condition when charging and discharging the refrigerant. To avoid fire or explosion, dissipate static electricity during transfer by grounding and bonding containers and equipment before charging/discharging.



 CAUTION

Decommissioning

- Before carrying out this procedure, it is essential that the technician is completely familiar with the equipment and all its details.
- It is recommended good practice that all refrigerants are recovered safely.
- Prior to the task being carried out, an oil and refrigerant sample shall be taken in case analysis is required prior to re-use of reclaimed refrigerant.
- It is essential that electrical power is available before the task is commenced.
  - a) Become familiar with the equipment and its operation.
  - b) Isolate system electrically.
  - c) Before attempting the procedure ensure that:

- mechanical handling equipment is available, if required, for handling refrigerant cylinders;
- all personal protective equipment is available and being used correctly;
- the recovery process is supervised at all times by a competent person;
- recovery equipment and cylinders conform to the appropriate standards.

10.

- d) Pump down refrigerant system, if possible.
  - e) If a vacuum is not possible, make a manifold so that refrigerant can be removed from various parts of the system.
  - f) Make sure that cylinder is situated on the scales before recovery takes place.
  - g) Start the recovery machine and operate in accordance with manufacturer's instructions.
  - h) Do not over fill cylinders. (No more than 80 % volume liquid charge).
  - i) Do not exceed the maximum working pressure of the cylinder, even temporarily.
  - j) When the cylinders have been filled correctly and the process completed, make sure that the cylinders and the equipment are removed from site promptly and all isolation valves on the equipment are closed off.
  - k) Recovered refrigerant shall not be charged into another refrigeration system unless it has been cleaned and checked.
- Electrostatic charge may accumulate and create a hazardous condition when charging or discharging the refrigerant. To avoid fire or explosion, dissipate static electricity during transfer by grounding and bonding containers and equipment before charging/discharging.

Labelling

- 11.
- Equipment shall be labelled stating that it has been de-commissioned and emptied of refrigerant.
  - The label shall be dated and signed.
  - Ensure that there are labels on the equipment stating the equipment contains flammable refrigerant.

Recovery

- 12.
- When removing refrigerant from a system, either for servicing or decommissioning, it is recommended good practice that all refrigerants are removed safely.
  - When transferring refrigerant into cylinders, ensure that only appropriate refrigerant recovery cylinders are employed.
  - Ensure that the correct number of cylinders for holding the total system charge are available.
  - All cylinders to be used are designated for the recovered refrigerant and labelled for that refrigerant (i.e. special cylinders for the recovery of refrigerant).
  - Cylinders shall be complete with pressure relief valve and associated shut-off valves in good working order.
  - Recovery cylinders are evacuated and, if possible, cooled before recovery occurs.
  - The recovery equipment shall be in good working order with a set of instructions concerning the equipment that is at hand and shall be suitable for the recovery of flammable refrigerants.
  - In addition, a set of calibrated weighing scales shall be available and in good working order.
  - Hoses shall be complete with leak-free disconnect couplings and in good condition.
  - Before using the recovery machine, check that it is in satisfactory working order, has been properly maintained and that any associated electrical components are sealed to prevent ignition in the event of a refrigerant release. Consult manufacturer if in doubt.
  - The recovered refrigerant shall be returned to the refrigerant supplier in the correct recovery cylinder, and the relevant Waste Transfer Note arranged.
  - Do not mix refrigerants in recovery units and especially not in cylinders.
  - If compressors or compressor oils are to be removed, ensure that they have been evacuated to an acceptable level to make certain that flammable refrigerant does not remain within the lubricant.
  - The evacuation process shall be carried out prior to returning the compressor to the suppliers.
  - Only electric heating to the compressor body shall be employed to accelerate this process.
  - When oil is drained from a system, it shall be carried out safely.

### 3. Specifications

#### 3.1 WH-MDC05J3E5

Item		Unit	Refrigerant System		
Performance Test Condition			EN 14511 / EN14825		
Cooling Capacity	Condition (Ambient/Water)		A35W7		
	kW		5.00		
	BTU/h		17100		
	kcal/h		4300		
Cooling EER	W/W		3.31		
	kcal/hW		2.85		
Heating Capacity	Condition (Ambient/Water)		A7W35	A2W35	
	kW		5.00	5.00	
	BTU/h		17100	17100	
	kcal/h		4300	4300	
Heating COP	W/W		5.08	3.57	
	kcal/hW		4.37	3.07	
Heating ErP	Low Temperature Application (W35)		Warmer	Average	Colder
	Application	Climate			
	Pdesign	kW	5.0	5.0	6.0
	Tbivalent / TOL	°C	2 / 2	-10 / -10	-15 / -22
	SCOP / ns	(W/W) / %	6.00 / 237	5.12 / 202	4.08 / 160
	Annual Consumption	kWh	1113	2018	3625
	Class		A+++	A+++	A++
	Medium Temperature Application (W55)		Warmer	Average	Colder
	Application	Climate			
	Pdesign	kW	4.0	5.0	4.0
	Tbivalent / TOL	°C	2 / 2	-10 / -10	-15 / -22
	SCOP / ns	(W/W) / %	4.20 / 165	3.63 / 142	2.95 / 115
	Annual Consumption	kWh	1274	2849	3338
	Class		A+++	A++	A+
Noise Level	Condition (Ambient/Water)		A35W7	A7W35	A2W35
	dB (A)		Cooling: 49	Heating: 48	
	Power Level dB		Cooling: 65	Heating: 64 Heating: 59***	
Air Flow	m <sup>3</sup> /min (ft <sup>3</sup> /min)		Cooling: 51.0 (1800) Heating: 39.8 (1410)		
Refrigeration Control Device			Expansion Valve		
Refrigeration Oil	cm <sup>3</sup>		FW50S (900)		
Refrigerant (R32)	kg (oz)		1.30 (45.9)		
F-GAS	GWP		675		
	CO <sub>2</sub> eq (ton) (Precharged / Maximum)		0.878 / -		
Compressor	Type		Hermetic Motor		
	Motor Type		Brushless (4-poles)		
	Rated Output	kW	1.70		

Item		Unit	Refrigerant System		
Fan	Type		Propeller Fan		
	Material		PP		
	Motor Type		DC Motor (8-poles)		
	Input Power	W	-		
	Output Power	W	60		
	Fan Speed	rpm	Cooling: 650 Heating: 520		
Heat Exchanger	Fin material		Aluminium (Pre Coat)		
	Fin Type		Corrugated Fin		
	Row × Stage × FPI		2 × 30 × 17		
	Size (W × H × L)	mm	38.1 × 762 × 903.8:873.8		

Item		Unit	Mono Bloc Unit		
Power Source (Phase, Voltage, Cycle)		∅	Single		
		V	230		
		Hz	50		
Input Power	Condition (Ambient/Water)		A35W7	A7W35	A2W35
		kW	Cooling: 1.51	Heating: 0.985	Heating: 1.40
Maximum Input Power For Heatpump System		kW	2.59		
Power Supply 1 : Phase (∅) / Max. Current (A) / Max. Input Power (W)			1∅ / 12.0 / 2.59k		
Power Supply 2 : Phase (∅) / Max. Current (A) / Max. Input Power (W)			1∅ / 13.0 / 3.00k		
Power Supply 3 : Phase (∅) / Max. Current (A) / Max. Input Power (W)			- / - / -		
Starting Current		A	4.7		
Running Current	Condition (Ambient/Water)		A35W7	A7W35	A2W35
		A	Cooling: 7.0	Heating: 4.7	Heating: 6.6
Maximum Current For Heatpump System		A	12.0		
Power Factor Power factor means total figure of compressor and outdoor fan motor.		%	Cooling: 94	Heating: 91	Heating: 93
Dimension	Height	mm (inch)	865 (34-1/16)		
	Width	mm (inch)	1283 (50-17/32)		
	Depth	mm (inch)	320 (12-5/8)		
Net Weight		kg (lbs)	99 (218)		
Power Cord	Number of core		-		
	Length	m (ft)	-		
Thermostat			Electronic Control		
Protection Device			Electronic Control		

Item		Unit	Water System
Performance Test Condition			EN 14511 / EN14825
Operation Range	Outdoor Ambient	°C	Cooling: 10 ~ 43 Heating: -20 ~ 35
	Water Outlet	°C	Cooling: 5 ~ 20 Heating: 20 ~ 55 ( Below Ambient -15°C) 20 ~ 60 (Above Ambient -10°C)
Internal Pressure Differential		kPa	Cooling: 12.0 Heating: 12.0
Water Pipe Connector (in.)			(1-1/4)
Water Drain Hose Inner Diameter		mm (inch)	15.0 (19/32)
Pump	Motor Type		DC Motor
	Input Power	W	173
Hot Water Coil	Type		Brazed Plate
	No. of Plates		36
	Size (H × W × L)	mm	68.3 × 121 × 333
	Water Flow Rate	l/min (m <sup>3</sup> /h)	Cooling: 14.3 (0.9) Heating: 14.3 (0.9)
Pressure Relief Valve Water Circuit		kPa	Open: 300, Close: 210 and below
Flow Switch			Electronic Sensor
Protection Device		A	Residual Current Circuit Breaker (40)
Expansion Vessel	Volume	l	6
	MWP	bar	3
Capacity of Integrated Electric Heater		kW	3.00

**Note:**

- Cooling capacities are based on outdoor air temperature of 35°C Dry Bulb with controlled indoor water inlet temperature of 12°C and water outlet temperature of 7°C.
- Heating capacities are based on outdoor air temperature of 7°C Dry Bulb (44.6°F Dry Bulb), 6°C Wet Bulb (42.8°F Wet Bulb) with controlled indoor water inlet temperature of 30°C and water outlet temperature of 35°C.
- Specification are subjected to change without prior notice for further improvement.
- Flow rate indicated are based on nominal capacity adjustment of leaving water temperature (LWT) 35°C and =5°C

\*\*\* The sound power level is measured with accordance to EN12102 under conditions of the EN14825.

### 3.2 WH-MDC07J3E5

Item		Unit	Refrigerant System		
Performance Test Condition			EN 14511 / EN14825		
Cooling Capacity	Condition (Ambient/Water)		A35W7		
	kW		7.00		
	BTU/h		23900		
	kcal/h		6020		
Cooling EER	W/W		3.06		
	kcal/hW		2.63		
Heating Capacity	Condition (Ambient/Water)		A7W35	A2W35	
	kW		7.00	7.00	
	BTU/h		23900	23900	
	kcal/h		6020	6020	
Heating COP	W/W		4.76	3.40	
	kcal/hW		4.10	2.92	
Heating ErP	Low Temperature Application (W35)		Warmer	Average	Colder
	Application	Climate			
	Pdesign	kW	7.0	6.0	7.0
	Tbivalent / TOL	°C	2 / 2	-10 / -10	-15 / -22
	SCOP / ns	(W/W) / %	5.75 / 227	4.90 / 193	4.18 / 164
	Annual Consumption	kWh	1627	2532	4132
	Class		A+++	A+++	A++
	Medium Temperature Application (W55)		Warmer	Average	Colder
	Application	Climate			
	Pdesign	kW	6.0	7.0	6.0
	Tbivalent / TOL	°C	2 / 2	-7 / -10	-15 / -22
	SCOP / ns	(W/W) / %	4.07 / 160	3.32 / 130	2.98 / 116
	Annual Consumption	kWh	1971	4354	4967
	Class		A+++	A++	A+
Noise Level	Condition (Ambient/Water)		A35W7	A7W35	A2W35
	dB (A)		Cooling: 50	Heating: 50	
	Power Level dB		Cooling: 67	Heating: 68 Heating: 59***	
Air Flow	m <sup>3</sup> /min (ft <sup>3</sup> /min)		Cooling: 52.8 (1860) Heating: 43.3 (1530)		
Refrigeration Control Device			Expansion Valve		
Refrigeration Oil	cm <sup>3</sup>		FW50S (900)		
Refrigerant (R32)	kg (oz)		1.30 (45.9)		
F-GAS	GWP		675		
	CO <sub>2</sub> eq (ton) (Precharged / Maximum)		0.878 / -		
Compressor	Type		Hermetic Motor		
	Motor Type		Brushless (4-poles)		
	Rated Output	kW	1.70		

Item		Unit	Refrigerant System
Fan	Type		Propeller Fan
	Material		PP
	Motor Type		DC Motor (8-poles)
	Input Power	W	-
	Output Power	W	60
	Fan Speed	rpm	Cooling: 670 Heating: 560
Heat Exchanger	Fin material		Aluminium (Pre Coat)
	Fin Type		Corrugated Fin
	Row × Stage × FPI		2 × 30 × 17
	Size (W × H × L)	mm	38.1 × 762 × 903.8:873.8

Item		Unit	Mono Bloc Unit		
Power Source (Phase, Voltage, Cycle)		ø	Single		
		V	230		
		Hz	50		
Input Power		Condition (Ambient/Water)	A35W7	A7W35	A2W35
		kW	Cooling: 2.29	Heating: 1.47	Heating: 2.06
Maximum Input Power For Heatpump System		kW	3.71		
Power Supply 1 : Phase (Ø) / Max. Current (A) / Max. Input Power (W)			1Ø / 17.0 / 3.71k		
Power Supply 2 : Phase (Ø) / Max. Current (A) / Max. Input Power (W)			1Ø / 13.0 / 3.00k		
Power Supply 3 : Phase (Ø) / Max. Current (A) / Max. Input Power (W)			- / - / -		
Starting Current		A	7.0		
Running Current		Condition (Ambient/Water)	A35W7	A7W35	A2W35
		A	Cooling: 10.5	Heating: 7.0	Heating: 9.5
Maximum Current For Heatpump System		A	17.0		
Power Factor Power factor means total figure of compressor and outdoor fan motor.		%	Cooling: 95	Heating: 92	Heating: 94
Dimension	Height	mm (inch)	865 (34-1/16)		
	Width	mm (inch)	1283 (50-17/32)		
	Depth	mm (inch)	320 (12-5/8)		
Net Weight		kg (lbs)	104 (229)		
Power Cord	Number of core		-		
	Length	m (ft)	-		
Thermostat			Electronic Control		
Protection Device			Electronic Control		

Item		Unit	Water System
Performance Test Condition			EN 14511 / EN14825
Operation Range	Outdoor Ambient	°C	Cooling: 10 ~ 43 Heating: -20 ~ 35
	Water Outlet	°C	Cooling: 5 ~ 20 Heating: 20 ~ 55 ( Below Ambient -15°C) 20 ~ 60 (Above Ambient -10°C)
Internal Pressure Differential		kPa	Cooling: 22.0 Heating: 22.0
Water Pipe Connector (in.)			(1-1/4)
Water Drain Hose Inner Diameter		mm (inch)	15.0 (19/32)
Pump	Motor Type		DC Motor
	Input Power	W	173
Hot Water Coil	Type		Brazed Plate
	No. of Plates		36
	Size (H × W × L)	mm	68.3 × 121 × 333
	Water Flow Rate	l/min (m <sup>3</sup> /h)	Cooling: 20.1 (1.2) Heating: 20.1 (1.2)
Pressure Relief Valve Water Circuit		kPa	Open: 300, Close: 210 and below
Flow Switch			Electronic Sensor
Protection Device		A	Residual Current Circuit Breaker (40)
Expansion Vessel	Volume	l	6
	MWP	bar	3
Capacity of Integrated Electric Heater		kW	3.00

**Note:**

- Cooling capacities are based on outdoor air temperature of 35°C Dry Bulb with controlled indoor water inlet temperature of 12°C and water outlet temperature of 7°C.
- Heating capacities are based on outdoor air temperature of 7°C Dry Bulb (44.6°F Dry Bulb), 6°C Wet Bulb (42.8°F Wet Bulb) with controlled indoor water inlet temperature of 30°C and water outlet temperature of 35°C.
- Specification are subjected to change without prior notice for further improvement.
- Flow rate indicated are based on nominal capacity adjustment of leaving water temperature (LWT) 35°C and =5°C

\*\*\* The sound power level is measured with accordance to EN12102 under conditions of the EN14825.

### 3.3 WH-MDC09J3E5

Item		Unit	Refrigerant System		
Performance Test Condition			EN 14511 / EN14825		
Cooling Capacity	Condition (Ambient/Water)		A35W7		
	kW		9.00		
	BTU/h		30700		
	kcal/h		7740		
Cooling EER	W/W		2.71		
	kcal/hW		2.33		
Heating Capacity	Condition (Ambient/Water)		A7W35	A2W35	
	kW		9.00	7.45	
	BTU/h		30700	25400	
	kcal/h		7740	6410	
Heating COP	W/W		4.48	3.13	
	kcal/hW		3.85	2.69	
Heating ErP	Low Temperature Application (W35)		Warmer	Average	Colder
	Application	Climate			
	Pdesign	kW	7.0	7.0	7.0
	Tbivalent / TOL	°C	2 / 2	-10 / -10	-15 / -22
	SCOP / ns	(W/W) / %	5.75 / 227	4.90 / 193	4.18 / 164
	Annual Consumption	kWh	1627	2949	4132
	Class		A+++	A+++	A++
	Medium Temperature Application (W55)		Warmer	Average	Colder
	Application	Climate			
	Pdesign	kW	6.0	8.0	6.0
	Tbivalent / TOL	°C	2 / 2	-7 / -10	-15 / -22
	SCOP / ns	(W/W) / %	4.07 / 160	3.32 / 130	2.98 / 116
	Annual Consumption	kWh	1971	4971	4967
	Class		A+++	A++	A+
	Noise Level	Condition (Ambient/Water)		A35W7	A7W35
dB (A)			Cooling: 51	Heating: 51	
Power Level dB			Cooling: 68	Heating: 69 Heating: 59***	
Air Flow	m <sup>3</sup> /min (ft <sup>3</sup> /min)		Cooling: 55.4 (1960) Heating: 53.2 (1880)		
Refrigeration Control Device			Expansion Valve		
Refrigeration Oil	cm <sup>3</sup>		FW50S (900)		
Refrigerant (R32)	kg (oz)		1.30 (45.9)		
F-GAS	GWP		675		
	CO <sub>2</sub> eq (ton) (Precharged / Maximum)		0.878 / -		
Compressor	Type		Hermetic Motor		
	Motor Type		Brushless (4-poles)		
	Rated Output	kW	1.70		



Item		Unit	Refrigerant System		
Fan	Type		Propeller Fan		
	Material		PP		
	Motor Type		DC Motor (8-poles)		
	Input Power	W	-		
	Output Power	W	60		
	Fan Speed	rpm	Cooling: 700 Heating: 670		
Heat Exchanger	Fin material		Aluminium (Pre Coat)		
	Fin Type		Corrugated Fin		
	Row × Stage × FPI		2 × 30 × 17		
	Size (W × H × L)	mm	38.1 × 762 × 903.8:873.8		

Item		Unit	Mono Bloc Unit		
Power Source (Phase, Voltage, Cycle)		∅	Single		
		V	230		
		Hz	50		
Input Power		Condition (Ambient/Water)	A35W7	A7W35	A2W35
		kW	Cooling: 3.32	Heating: 2.01	Heating: 2.38
Maximum Input Power For Heatpump System		kW	3.83		
Power Supply 1 : Phase (∅) / Max. Current (A) / Max. Input Power (W)			1∅ / 17.0 / 3.83k		
Power Supply 2 : Phase (∅) / Max. Current (A) / Max. Input Power (W)			1∅ / 13.0 / 3.00k		
Power Supply 3 : Phase (∅) / Max. Current (A) / Max. Input Power (W)			- / - / -		
Starting Current		A	9.3		
Running Current		Condition (Ambient/Water)	A35W7	A7W35	A2W35
		A	Cooling: 14.7	Heating: 9.3	Heating: 11.0
Maximum Current For Heatpump System		A	17.0		
Power Factor Power factor means total figure of compressor and outdoor fan motor.		%	Cooling: 98	Heating: 94	Heating: 94
Dimension	Height	mm (inch)	865 (34-1/16)		
	Width	mm (inch)	1283 (50-17/32)		
	Depth	mm (inch)	320 (12-5/8)		
Net Weight		kg (lbs)	104 (229)		
Power Cord	Number of core		-		
	Length	m (ft)	-		
Thermostat			Electronic Control		
Protection Device			Electronic Control		

Item		Unit	Water System
Performance Test Condition			EN 14511 / EN14825
Operation Range	Outdoor Ambient	°C	Cooling: 10 ~ 43 Heating: -20 ~ 35
	Water Outlet	°C	Cooling: 5 ~ 20 Heating: 20 ~ 55 ( Below Ambient -15°C) 20 ~ 60 (Above Ambient -10°C)
Internal Pressure Differential		kPa	Cooling: 32.0 Heating: 32.0
Water Pipe Connector (in.)			(1-1/4)
Water Drain Hose Inner Diameter		mm (inch)	15.0 (19/32)
Pump	Motor Type		DC Motor
	Input Power	W	173
Hot Water Coil	Type		Brazed Plate
	No. of Plates		36
	Size (W × H × L)	mm	68.3 × 121 × 333
	Water Flow Rate	l/min (m <sup>3</sup> /h)	Cooling: 25.8 (1.5) Heating: 25.8 (1.5)
Pressure Relief Valve Water Circuit		kPa	Open: 300, Close: 210 and below
Flow Switch			Electronic Sensor
Protection Device		A	Residual Current Circuit Breaker (40)
Expansion Vessel	Volume	l	6
	MWP	bar	3
Capacity of Integrated Electric Heater		kW	3.00

**Note:**

- Cooling capacities are based on outdoor air temperature of 35°C Dry Bulb with controlled indoor water inlet temperature of 12°C and water outlet temperature of 7°C.
- Heating capacities are based on outdoor air temperature of 7°C Dry Bulb (44.6°F Dry Bulb), 6°C Wet Bulb (42.8°F Wet Bulb) with controlled indoor water inlet temperature of 30°C and water outlet temperature of 35°C.
- Specification are subjected to change without prior notice for further improvement.
- Flow rate indicated are based on nominal capacity adjustment of leaving water temperature (LWT) 35°C and =5°C

\*\*\* The sound power level is measured with accordance to EN12102 under conditions of the EN14825.

## 4. Features

- **Inverter Technology**
  - Energy saving
- **High Efficiency**
- **Compact Design**
- **Environment Protection**
  - Non-ozone depletion substances refrigerant (R410A)
- **Easy to use control panel**
- **Weekly Timer setting**
- **Quality Improvement**
  - Random auto restart after power failure for safety restart operation
  - Gas leakage protection
  - Prevent compressor reverse cycle
  - Inner protector to protect compressor
- **Serviceability Improvement**
  - Breakdown Self Diagnosis function
  - System Status Check Buttons for servicing purpose
  - System Pumpdown Button for servicing purpose
  - Front maintenance design for outdoor unit
- **Operation Condition**

	HEATING (CIRCUIT)	<sup>*1, *2</sup> COOLING (CIRCUIT)
Water outlet temperature (°C) (Min. / Max.)	20 / 55 (Below Ambient -15 °C) <sup>*3</sup> 20 / 60 (Above Ambient -10 °C) <sup>*3</sup>	5 / 20
Outdoor ambient temperature (°C) (Min. / Max.)	-20 / 35	10 / 43

NOTICE: When the outdoor temperature is out of the range in the table, the heating capacity will drop significantly and the mono bloc unit may stop operating for its protection.

The unit will restart automatically after the outdoor temperature returns to the specified range.

<sup>\*1</sup> The system is locked to operate without COOL mode. It can be unlocked only by authorised installers or our authorized service partners.

<sup>\*2</sup> Only displayed when COOL mode is unlocked (This means when COOL mode is available).

<sup>\*3</sup> Between outdoor ambient -10°C and -15°C, the water outlet temperature gradually decreases from 60°C to 55°C.

# 5. Location of Controls and Components

## 5.1 Indoor Unit

### 5.1.1 Location of Control

**Buttons / Indicator**

Buttons / Indicator	
①	<b>Quick Menu button</b> (For more details, refer to the separate Quick Menu Guide.)
②	<b>Back button</b> Returns to the previous screen
③	<b>LCD Display</b>
④	<b>Main Menu button</b> For function setup
⑤	<b>ON/OFF button</b> Starts/Stops operation
⑥	<b>Operation indicator</b> Illuminates during operation, blinks during alarm.

**Cross key buttons**  
Selects an item.

	Up	
Left	▲	▶
	↻	
	▼	
	Down	

**Enter button**  
Fixes the selected content.

**! Press centre**

**⊘ No glove**

**⊘ No pen**

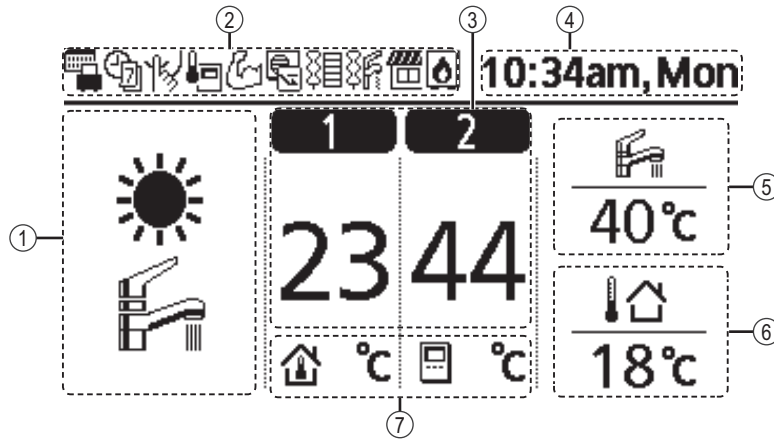

**Display**

① **Mode selection**

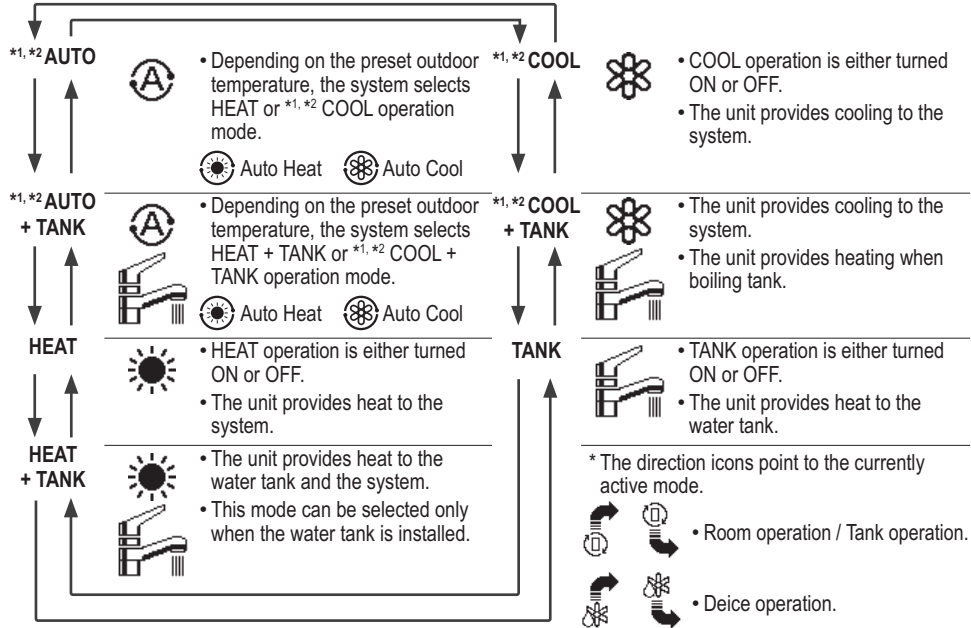

② **Operation icons**

The status of operation is displayed. Icon will not display (under operation OFF screen) whenever operation is OFF except weekly timer.

- |   |                               |  |
|---|-------------------------------|--|
| Holiday operation status                        | Weekly Timer operation status | Quiet operation status                   |
| Zone:Room Thermostat<br>→Internal sensor status | Powerful operation status     | Demand Control or SG ready or SHP status |
| Room Heater status                              | Tank Heater status            | Solar status                             |
| Bivalent status (Boiler)                        |                               |  |

\*1 The system is locked to operate without COOL mode. It can be unlocked only by authorised installers or our authorised service partners.  
\*2 Only displayed when COOL mode is unlocked (This means when COOL mode is available).

③ **Temperature of each zone**

④ **Time and day**

⑤ **Water Tank temperature**

⑥ **Outdoor temperature**

⑦ **Sensor type/Set temperature type icons**

- |  |                              |                 |
|--|------------------------------|-----------------|
| Water Temperature<br>→Compensation curve | Water Temperature<br>→Direct | Pool only       |
| Room Thermostat<br>→External             | Room Thermostat<br>→Internal | Room Thermostat |

## 5.1.2 Initialization

Before starting to install the various menu settings, please initiate the Remote Controller by selecting the language of operation and installing the date and time correctly. When power is turned on for the first time, it becomes the setting screen automatically. It can also be set from personal setting of the menu.

### Selecting the language

Wait while the display is initializing.  
When initializing screen ends, it turns to normal screen.  
When any button is pressed, language setting screen appears.

- ① Scroll with ▼ and ▲ to select the language.
- ② Press ↵ to confirm the selection.

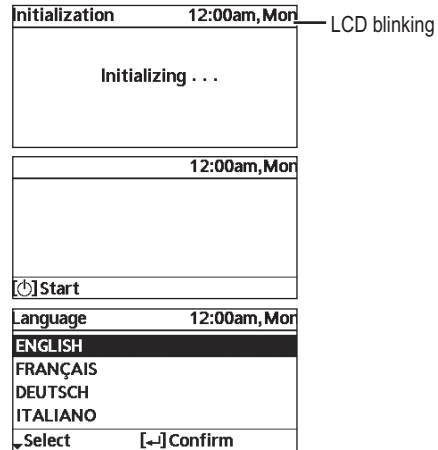

### Setting the clock

- ① Select with ▼ or ▲ how to display the time, either 24h or am/pm format (for example, 15:00 or 3:00 pm).
- ② Press ↵ to confirm the selection.
- ③ Use ▼ and ▲ to select year, month, day, hour and minutes. (Select and move with ► and press ↵ to confirm.)
- ④ Once the time is set, time and day will appear on the display even if the Remote Controller is turned OFF.

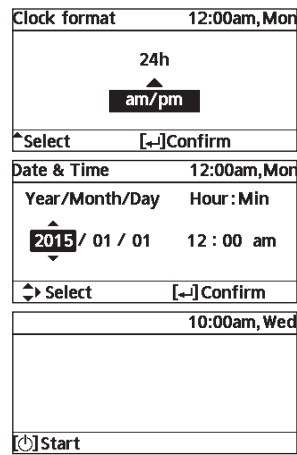

## 5.1.3 Quick Menu

After the initial settings have been completed, you can select a quick menu from the following options and edit the setting.

- ① Press  to display the quick menu.

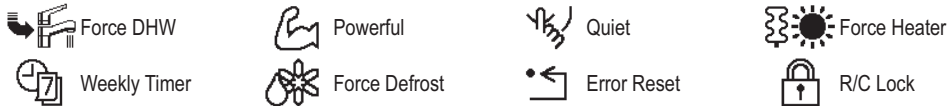
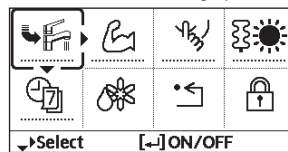

- ② Use ▲ ▼ ◀ ▶ to select menu.
- ③ Press ↵ to turn on/off the select menu.

## 5.1.4 Menus For user

Select menus and determine settings according to the system available in the household. All initial settings must be done by an authorised dealer or a specialist. It is recommended that all alterations of the initial settings are also done by an authorised dealer or a specialist.

- After initial installation, you may manually adjust the settings.
- The initial setting remains active until the user changes it.
- The Remote Controller can be used for multiple installations.
- Ensure the operation indicator is OFF before setting.
- The system may not work properly if set wrongly.  
Please consult an authorised dealer.



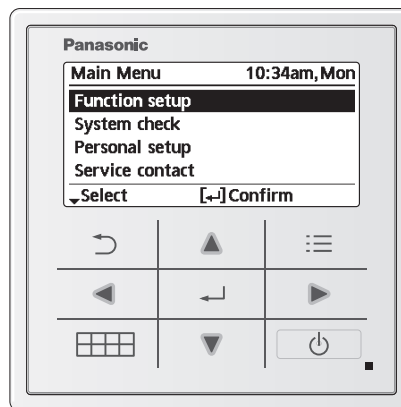

To display <Main Menu>: ☰

To select menu: ▲ ▼ ◀ ▶

To confirm the selected content: ↵

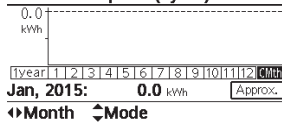

Menu	Default Setting	Setting Options / Display
<b>1 Function setup</b>		
<b>1.1 &gt; Weekly timer</b>		
Once the weekly timer is set up, User can edit from Quick Menu. To set up to 6 patterns of operation on a daily basis. • Disabled if Heat-Cool SW is select "Yes" or if Force Heater is on.	<b>Timer setup</b> Select day of the week and set the patterns needed (Time / Operation ON/OFF / Mode)  <b>Timer copy</b> Select day of the week	<b>Weekly timer</b> 10:34am, Mon Sun Mon Tue Wed Thu Fri Sat 1. 8:00am ON 40°C 2. 12:00pm ON 24/28°C 40°C 3. 1:00pm ON 12/10°C ↕Day ↘Pattern [↵]Edit
<b>1.2 &gt; Holiday timer</b>		
To save energy, a holiday period may be set to either turn OFF the system or lower the temperature during the period.  • Weekly timer setting may be temporarily disabled during Holiday timer setting but it will be restored once the Holiday timer is completed.	OFF <div style="text-align: right;">             ON              ▲              OFF           </div>	<b>Holiday: End</b> 10:34am, Mon <b>Year/Month/Day</b> Hour : Min 2015 / 01 / 07 10 : 00 am ↕Select [↵]Confirm
<b>1.3 &gt; Quiet timer</b>		
To operate quietly during the preset period. 6 patterns may be set. Level 0 means the mode is off.	Time to start Quiet : Date and time  Level of quietness: 0 ~ 3	<b>Quiet</b> 10:34am, Mon <b>Pattern</b> <b>Time</b> <b>Level</b> 1 8:00 am 0 2 5:00pm 1 3 11:00pm 3 ↕Select [↵]Edit
<b>1.4 &gt; Room heater</b>		
To set the room heater ON or OFF.	OFF	ON ▲ OFF
<b>1.5 &gt; Tank heater</b>		
To set the tank heater ON or OFF.  • Available only if connected to the tank.	OFF	ON ▲ OFF
<b>1.6 &gt; Sterilization</b>		
To set the auto sterilization ON or OFF.  • Available only if connected to the tank. • Do not use the system during sterilization in order to prevent scalding with hot water, or overheating of shower. • Ask an authorised dealer to determine the level of sterilization function field settings according to the local laws and regulations.	OFF	ON ▲ OFF

Menu	Default Setting	Setting Options / Display
<b>2 System check</b>		
<b>2.1 &gt; Energy monitor</b>		
Present or historical chart of energy consumption, generation or COP.	<b>Present</b> Select and retrieve	<b>Total consumption (1year)</b> 
	<b>Historical chart</b> Select and retrieve	
<ul style="list-style-type: none"> <li>• COP= Coefficient of Performance.</li> <li>• For historical chart, the period is selected from 1 day/1 week/1year.</li> <li>• Energy consumption (kWh) of heating, *1.*2 cooling, tank and total may be retrieved.</li> <li>• The total power consumption is an estimated value based on AC 230 V and may differ from value measured by precise equipment.</li> </ul>		
<b>2.2 &gt; System information</b>		
Shows all system information in each area.	<b>Actual system information of 10 items:</b> Inlet / Outlet / Zone 1 / Zone 2 / Tank / Buffer tank / Solar / Pool / COMP frequency / Pump flowrate Select and retrieve	<b>System information 10:34am, Mon</b> 1. Inlet : 0 °C 2. Outlet : 0 °C 3. Zone 1 : 0 °C 4. Zone 2 : 0 °C ↵Page
<b>2.3 &gt; Error history</b>		
<ul style="list-style-type: none"> <li>• Refer to Troubleshooting for error codes.</li> <li>• The most recent error code is displayed at the top.</li> </ul>	Select and retrieve	<b>Error history 10:34am, Mon</b> 1. -- 2. -- 3. -- 4. -- [←] Clear history
<b>2.4 &gt; Compressor</b>		
Shows the compressor performance.	Select and retrieve	<b>Compressor 10:34am, Mon</b> 1. Current frequency : 0 Hz 2. (OFF-ON) counter : 0 3. Total ON time : 0 h [⇒] Back
<b>2.5 &gt; Heater</b>		
Total hours of ON time for Room heater/Tank heater.	Select and retrieve	<b>Heater 10:34am, Mon</b> <b>Total ON time</b>  : 0h  : 0h [⇒] Back
<b>3 Personal setup</b>		
<b>3.1 &gt; Touch sound</b>		
Turns the operation sound ON/OFF.	ON	
<b>3.2 &gt; LCD contrast</b>		
Sets the screen contrast.	3	<b>LCD contrast 10:34am, Mon</b> Low  High ↵Select [←] Confirm

\*1 The system is locked to operate without COOL mode. It can be unlocked only by authorised installers or our authorised service partners.  
\*2 Only displayed when COOL mode is unlocked (This means when COOL mode is available).



Menu	Default Setting	Setting Options / Display
<b>3.3 &gt; Backlight</b>		
Sets the duration of screen backlight.	1 min	Backlight 10:34am, Mon OFF 5 mins 15 secs 10 mins <b>1 min</b> ^Select [-]Confirm
<b>3.4 &gt; Backlight intensity</b>		
Sets screen backlight brightness.	4	Backlight intensity 10:34am, Mon Dark Bright ◀ ██████████ ▶ ◀ Select [-]Confirm
<b>3.5 &gt; Clock format</b>		
Sets the type of clock display.	24h	Clock format 10:34am, Mon <b>24h</b> am/pm ▼Select [-]Confirm
<b>3.6 &gt; Date &amp; Time</b>		
Sets the present date and time.	Year / Month / Day / Hour / Min	Date & Time 10:34am, Mon Year/Month/Day Hour : Min <b>2015</b> / 01 / 07 10 : 00 am ↕Select [-]Confirm
<b>3.7 &gt; Language</b>		
Sets the display language for the top screen.  • For Greek, please refer to the English version.	ENGLISH / FRANÇAIS / DEUTSCH / ITALIANO / ESPAÑOL / DANISH / SWEDISH / NORWEGIAN / POLISH / CZECH / NEDERLANDS / TÜRKÇE / SUOMI / MAGYAR / SLOVENŠČINA / HRVATSKI	Language 10:34am, Mon <b>ENGLISH</b> FRANÇAIS DEUTSCH ITALIANO ▼Select [-]Confirm
<b>3.8 &gt; Unlock password</b>		
4 digit password for all the settings.	0000	Unlock password 10:34am, Mon <b>0000</b> ↕Select [-]Confirm
<b>4 Service contact</b>		
<b>4.1 &gt; Contact 1 / Contact 2</b>		
Preset contact number for installer.	Select and retrieve	Service setup 10:34am, Mon Contact 1 Name : Bryan Adams ☎ : 08812345678 ▼Select

## 5.1.5 Menus For installer

Menu	Default Setting	Setting Options / Display
<b>5 Installer setup &gt; System setup</b>		
<b>5.1 &gt; Optional PCB connectivity</b>		
To connect to the external PCB required for servicing.	No	Yes ▲ No
<p>• If the external PCB is connected (optional), the system will have following additional functions:</p> <ul style="list-style-type: none"> <li>① Buffer tank connection and control over its function and temperature.</li> <li>② Control over 2 zones (including the swimming pool and the function to heat water in it).</li> <li>③ Solar function (the solar thermal panels connected to either the DHW (Domestic Hot Water) Tank or the Buffer Tank. <ul style="list-style-type: none"> <li>• DHW is not applicable for WH-ADC *models.</li> </ul> </li> <li>④ External compressor switch.</li> <li>⑤ External error signal.</li> <li>⑥ SG ready control.</li> <li>⑦ Demand control.</li> <li>⑧ Heat-Cool SW</li> </ul>		
<b>5.2 &gt; Zone &amp; Sensor</b>		
To select the sensors and to select either 1 zone or 2 zone system.	<p><b>Zone</b></p> <ul style="list-style-type: none"> <li>• After selecting 1 or 2 zone system, proceed to the selection of room or swimming pool.</li> <li>• If the swimming pool is selected, the temperature must be selected for <math>\Delta T</math> temperature between 0°C ~ 10 °C.</li> </ul> <p><b>Sensor</b></p> <p>* For room thermostat, there is a further selection of external or internal.</p>	<p><b>Zone &amp; Sensor</b> 10:34am, Mon</p> <p><b>Zone</b></p> <p>1 Zone system 2 Zones system</p> <p>▼Select    [←] Confirm</p> <hr/> <p><b>Zone &amp; Sensor</b> 10:34am, Mon</p> <p><b>Sensor</b></p> <p>Water temperature Room thermostat Room thermistor</p> <p>▼Select    [←] Confirm</p>
<b>5.3 &gt; Heater capacity</b>		
To reduce the heater power if unnecessary.* 3 kW / 6 kW / 9kW		<p><b>Heater capacity</b> 10:34am, Mon</p> <p>3 kW</p> <p>[←] Confirm</p>
* Options of kW vary depending on the model.		
<b>5.4 &gt; Anti freezing</b>		
To activate or deactivate the water freeze prevention when the system is OFF	Yes	Yes ▼ No
<b>5.5 &gt; Tank connection</b>		
To connect tank to the system.	No	Yes ▲ No
<b>5.6 &gt; DHW capacity</b>		
To select tank heating capacity to variable or standard. Variable capacity heat up tank with fast mode and keep the tank temperature with efficient mode. While standard capacity heat up tank with rated heating capacity. * This option is available if Tank connection is selected (YES).	Variable	Variable ▼ Standard

Menu	Default Setting	Setting Options / Display
<b>5.7 &gt; Buffer tank connection</b>		
<p>To connect tank to the system and if selected YES, to set <math>\Delta T</math> temperature.</p> <ul style="list-style-type: none"> <li>The optional PCB connectivity must be selected YES to enable the function.</li> <li>If the optional PCB connectivity is not selected, the function will not appear on the display.</li> </ul>	No	<p style="text-align: center;">Yes ▲ No</p>
	<b>&gt; Yes</b>	
	5 °C	<p>Set <math>\Delta T</math> for Buffer Tank</p> <p>Buffer Tank 10:34am, Mon <math>\Delta T</math> for Buffer Tank Range: (0°C~10°C) Steps: <math>\pm 1^\circ\text{C}</math></p> <p style="text-align: center;">5 °C</p> <p>↕Select    [←] Confirm</p>
<b>5.8 &gt; Tank heater</b>		
<p>To select external or internal tank heater and if External is selected, set a timer for the heater to come on.</p> <p>* This option is available if Tank connection is selected (YES).</p>	Internal	<p>Tank heater 10:34am, Mon</p> <p style="text-align: center;">External ▲ Internal</p> <p>^Select    [←] Confirm</p>
	<b>&gt; External</b>	
	0:20	<p>Tank heater 10:34am, Mon Tank heater: ON time Range: (0:20~3:00) Steps: <math>\pm 0:05</math></p> <p style="text-align: center;">0:20</p> <p>↕Select    [←] Confirm</p>
<b>5.9 &gt; Base pan heater</b>		
<p>To select whether or not optional base pan heater is connected.</p> <p>* Type A - The base pan heater activates only during deice operation.</p> <p>* Type B - The base pan heater activates when outdoor ambient temperature is 5 °C or lower.</p>	No	<p style="text-align: center;">Yes ▲ No</p>
	<b>&gt; Yes</b>	
	A	<p>Set base pan heater type*.</p> <p>Base pan heater type 10:34am, Mon</p> <p style="text-align: center;">A ▼ B</p> <p>↕Select    [←] Confirm</p>
<b>5.10 &gt; Alternative outdoor sensor</b>		
To select an alternative outdoor sensor.	No	<p style="text-align: center;">Yes ▲ No</p>
<b>5.11 &gt; Bivalent connection</b>		
To select to enable or disable bivalent connection.	No	<p style="text-align: center;">Yes ▲ No</p>
<b>&gt; Yes</b>		
<p>To select either auto control pattern or SG ready input control pattern.</p> <p>* This selection only display to select when optional pcb connection set to Yes.</p>	Auto	<p style="text-align: center;">Auto ▼ SG ready</p>

Menu	Default Setting	Setting Options / Display
<p>To select a bivalent connection to allow an additional heat source such as a boiler to heat-up the buffer tank and domestic hot water tank when heatpump capacity is insufficient at low outdoor temperature. The bivalent feature can be set-up either in alternative mode (heatpump and boiler operate alternately), or in parallel mode (both heatpump and boiler operate simultaneously), or in advance parallel mode (heatpump operates and boiler turns on for buffer-tank and/or domestic hot water depending on the control pattern setting options).</p>	<b>&gt; Yes &gt; Auto</b>	
	-5 °C	<p>Set outdoor temperature for turn ON Bivalent connection.</p> <p>Bivalent connection 10:34am, Mon Turn ON: Outdoor temp Range: (-15°C~35°C) Steps: ±1°C</p> <p style="text-align: right;">-5 °C</p> <p>↕Select    [←] Confirm</p>
	<b>Yes &gt; After selecting the outdoor temperature</b>	
	<b>Control pattern</b>	<p>Bivalent connection 10:34am, Mon Control pattern</p> <p style="text-align: center;">Alternative Parallel <b>Advanced parallel</b></p> <p>^Select    [←] Confirm</p>
	Alternative / Parallel / Advanced parallel	
	• Select advanced parallel for bivalent use of the tanks.	
	<b>Control pattern &gt; Alternative</b>	
	OFF	<p>Option to set external pump either ON or OFF during bivalent operation. Set to ON if system is simple bivalent connection.</p> <p>Bivalent connection 10:34am, Mon External pump</p> <p style="text-align: center;">ON <b>OFF</b></p> <p>^Select    [←] Confirm</p>
	<b>Control pattern &gt; Advanced parallel</b>	
	Heat	<p>Bivalent connection 10:34am, Mon Advanced parallel</p> <p style="text-align: center;"><b>Heat</b> DHW</p> <p>↕Select    [←] Confirm</p>
Selection of the tank		
• "Heat" implies Buffer Tank and "DHW" implies Domestic Hot Water Tank.		
<b>Control pattern &gt; Advanced parallel &gt; Heat &gt; Yes</b>		
• Buffer Tank is activated only after selecting "Yes".	<p>Bivalent connection 10:34am, Mon Advanced parallel: Heat</p> <p style="text-align: center;"><b>Yes</b> No</p> <p>↕Select    [←] Confirm</p>	
-8 °C	<p>Set the temperature threshold to start the bivalent heat source.</p> <p>Bivalent connection 10:34am, Mon Heat start: Target temp. Range: (-10°C~0°C) Steps: ±1°C</p> <p style="text-align: right;">-8 °C</p> <p>↕Select    [←] Confirm</p>	
0:30	<p>Delay timer to start the bivalent heat source (in hour and minutes).</p> <p>Bivalent connection 10:34am, Mon Heat start: Delay time Range: (0:00~1:30) Steps: ±0:05</p> <p style="text-align: right;">0:30</p> <p>↕Select    [←] Confirm</p>	
-2 °C	<p>Set the temperature threshold to stop the bivalent heat source.</p> <p>Bivalent connection 10:34am, Mon Heat stop: Target temp. Range: (-10°C~0°C) Steps: ±1°C</p> <p style="text-align: right;">-2 °C</p> <p>↕Select    [←] Confirm</p>	

Menu	Default Setting	Setting Options / Display																		
	0:30	Delay timer to stop the bivalent heat source (in hour and minutes). Bivalent connection 10:34am, Mon Heat stop: Delay time Range: (0:00~1:30) Steps: ±0:05 <b>0:30</b> ↕Select    [-] Confirm																		
	<b>Control pattern &gt; Advanced parallel &gt; DHW &gt; Yes</b>																			
	• DHW Tank is activated only after selecting "Yes".	Bivalent connection 10:34am, Mon Advanced parallel: DHW <b>Yes</b> No ↓Select    [-] Confirm																		
	0:30	Delay timer to start the bivalent heat source (in hour and minutes). Bivalent connection 10:34am, Mon DHW: Delay time Range: (0:30~1:30) Steps: ±0:05 <b>0:30</b> ↕Select    [-] Confirm																		
SG ready input control for bivalent system follow below input condition. <table border="1"> <thead> <tr> <th colspan="2">SG signal</th> <th>Operation pattern</th> </tr> <tr> <th>Vcc-bit1</th> <th>Vcc-bit2</th> <th></th> </tr> </thead> <tbody> <tr> <td>Open</td> <td>Open</td> <td>Heat Pump OFF, Boiler OFF</td> </tr> <tr> <td>Short</td> <td>Open</td> <td>Heat Pump ON, Boiler OFF</td> </tr> <tr> <td>Open</td> <td>Short</td> <td>Heat Pump OFF, Boiler ON</td> </tr> <tr> <td>Short</td> <td>Short</td> <td>Heat Pump ON, Boiler ON</td> </tr> </tbody> </table>	SG signal		Operation pattern	Vcc-bit1	Vcc-bit2		Open	Open	Heat Pump OFF, Boiler OFF	Short	Open	Heat Pump ON, Boiler OFF	Open	Short	Heat Pump OFF, Boiler ON	Short	Short	Heat Pump ON, Boiler ON	<b>&gt; Yes &gt; SG ready</b>	Option to set external pump either ON or OFF during bivalent operation. Set to ON if system is simple bivalent connection. Bivalent connection 10:34am, Mon <b>External pump</b> ON <b>OFF</b> ^Select    [-] Confirm
SG signal		Operation pattern																		
Vcc-bit1	Vcc-bit2																			
Open	Open	Heat Pump OFF, Boiler OFF																		
Short	Open	Heat Pump ON, Boiler OFF																		
Open	Short	Heat Pump OFF, Boiler ON																		
Short	Short	Heat Pump ON, Boiler ON																		
<b>5.12 &gt; External SW</b>	No	Yes <b>No</b>																		
<b>5.13 &gt; Solar connection</b>	No	Yes <b>No</b>																		
<ul style="list-style-type: none"> <li>The optional PCB connectivity must be selected YES to enable the function.</li> <li>If the optional PCB connectivity is not selected, the function will not appear on the display.</li> <li>DHW is not applicable for WH-ADC *models.</li> </ul>	<b>&gt; Yes</b>	Solar connection 10:34am, Mon <b>Buffer tank</b> DHW tank ↓Select    [-] Confirm																		
	<b>&gt; Yes &gt; After selecting the tank</b>	Solar connection 10:34am, Mon <b>ΔT Turn ON</b> Range: (6°C~15°C) Steps: ±1°C <b>10</b> °C ↕Select    [-] Confirm																		

Menu	Default Setting	Setting Options / Display
		<p>&gt; Yes &gt; After selecting the tank &gt; <math>\Delta</math>T ON temperature</p> <p>Solar connection 10:34am, Mon</p> <p><math>\Delta</math>T Turn OFF</p> <p>Range: (2°C-9°C)</p> <p>Steps: <math>\pm</math>1°C</p> <p>5 °C</p> <p>↕Select [-] Confirm</p>
		<p>&gt; Yes &gt; After selecting the tank &gt; <math>\Delta</math>T ON temperature &gt; <math>\Delta</math>T OFF temperature</p> <p>Solar connection 10:34am, Mon</p> <p>Anti freeze</p> <p>Range: (-20°C-10°C)</p> <p>Steps: <math>\pm</math>1°C</p> <p>5 °C</p> <p>↕Select [-] Confirm</p>
		<p>&gt; Yes &gt; After selecting the tank &gt; <math>\Delta</math>T ON temperature &gt; <math>\Delta</math>T OFF temperature &gt; After setting the antifreeze temperature</p> <p>Solar connection 10:34am, Mon</p> <p>Hi limit</p> <p>Range: (70°C-90°C)</p> <p>Steps: <math>\pm</math>5°C</p> <p>80 °C</p> <p>↕Select [-] Confirm</p>
5.14	> External error signal	
	No	<p>Yes</p> <p>No</p>
5.15	> Demand control	
	No	<p>Yes</p> <p>No</p>
5.16	> SG ready	
	No	<p>Yes</p> <p>No</p>
	> Yes	<p>SG ready 10:34am, Mon</p> <p>Capacity [1-0]: DHW</p> <p>Range: (50%-150%)</p> <p>Steps: <math>\pm</math>5%</p> <p>120 %</p> <p>↕Select [-] Confirm</p>
5.17	> External compressor SW	
	No	<p>Yes</p> <p>No</p>
5.18	> Circulation liquid	
	To select whether to circulate water or glycol in the system.	<p>Circulation liquid 10:34am, Mon</p> <p>Water</p> <p>Glycol</p> <p>↕Select [-] Confirm</p>

Menu	Default Setting	Setting Options / Display
<b>5.19 &gt; Heat-Cool SW</b>		
	No	Yes ▲ No
<b>5.20 &gt; Force heater</b>		
To turn on Force heater either manually (by default) or automatically.	Manual	Force heater 10:34am, Mon Auto ▲ Manual ▼ Select [-] Confirm
<b>5.21 &gt; Force defrost</b>		
If auto selection is set, the unit will start defrost operation if long heating hour operate during low outdoor temperature.	Manual	Auto ▲ Manual
<b>5.22 &gt; Defrost signal</b>		
To turn on defrost signal to stop fan coil during defrost operation. (If defrost signal set to yes, bivalent function will not available to use)	No	Yes ▲ No
<b>5.23 &gt; Pump flowrate</b>		
To set variable flow pump control or fix pump duty control.	$\Delta T$	$\Delta T$ ▼ Max. Duty

<b>6 Installer setup &gt; Operation setup</b>		
To access to the four major functions or modes.	4 main modes  Heat / *1, *2 Cool / *1, *2 Auto / Tank	Operation setup 10:34am, Mon Heat Cool Auto Tank ▼Select [-] Confirm
<b>6.1 &gt; Heat</b>		
To set various water & ambient temperatures for heating.	Water temp. for heating ON / Outdoor temp. for heating OFF / $\Delta T$ for heating ON / Heater ON/OFF	Operation setup 10:34am, Mon Heat Water temp. for heating ON Outdoor temp. for heating OFF $\Delta T$ for heating ON ▼Select [-] Confirm
	<b>&gt; Water temp. for heating ON</b>	
Compensation curve	Heating ON temperatures in compensation curve or direct input.	Operation setup 10:34am, Mon Heat ON: Water temp. Compensation curve Direct ▼Select [-] Confirm

\*1 The system is locked to operate without COOL mode. It can be unlocked only by authorised installers or our authorised service partners.

\*2 Only displayed when COOL mode is unlocked (This means when COOL mode is available).

Menu	Default Setting	Setting Options / Display
<b>&gt; Water temp. for heating ON &gt; Compensation curve</b>		
X axis: -5 °C, 15 °C Y axis: 55 °C, 35 °C	Input the 4 temperature points (2 on horizontal X axis, 2 on vertical Y axis).	<p>Heat ON: Water temp.:Zone1</p> <p>↕Select    [↔]Confirm</p>
<ul style="list-style-type: none"> <li>• Temperature range: X axis: -20 °C ~ 15 °C, Y axis: See below</li> <li>• Temperature range for the Y axis input: <ul style="list-style-type: none"> <li>1. WH-MDC model: 20 °C ~ 60 °C</li> </ul> </li> <li>• If 2 zone system is selected, the 4 temperature points must also be input for Zone 2.</li> <li>• "Zone 1" and "Zone 2" will not appear on the display if only 1 zone system.</li> </ul>		
<b>&gt; Water temp. for heating ON &gt; Direct</b>		
35 °C	Temperature for heating ON	<p>Operation setup    10:34am, Mon</p> <p>Heat ON: Water temp.:Zone2</p> <p>Range: (20°C-60°C)</p> <p>Steps: ±1°C    <b>35</b> °C</p> <p>↕Select    [↔]Confirm</p>
<ul style="list-style-type: none"> <li>• Min. ~ Max. range is conditional as follows: <ul style="list-style-type: none"> <li>1. WH-MDC model: 20 °C ~ 60 °C</li> </ul> </li> <li>• If 2 zone system is selected, temperature set point must input for Zone 2.</li> <li>• "Zone 1" and "Zone 2" will not appear on the display if only 1 zone system.</li> </ul>		
<b>&gt; Outdoor temp. for heating OFF</b>		
24 °C	Temperature for heating OFF	<p>Operation setup    10:34am, Mon</p> <p>Heat OFF: Outdoor temp.</p> <p>Range: (5°C-35°C)</p> <p>Steps: ±1°C    <b>24</b> °C</p> <p>↕Select    [↔]Confirm</p>
<b>&gt; ΔT for heating ON</b>		
5 °C	Set ΔT for heating ON. * This setting will not available to set when pump flowrate set to Max. duty.	<p>Operation setup    10:34am, Mon</p> <p>Heat ON: ΔT</p> <p>Range: (1°C-15°C)</p> <p>Steps: ±1°C    <b>5</b> °C</p> <p>↕Select    [↔]Confirm</p>
<b>&gt; Heater ON/OFF</b>		
<b>&gt; Heater ON/OFF &gt; Outdoor temp. for heater ON</b>		
0 °C	Temperature for heater ON	<p>Operation setup    10:34am, Mon</p> <p>Heater ON: Outdoor temp.</p> <p>Range: (-20°C-15°C)</p> <p>Steps: ±1°C    <b>0</b> °C</p> <p>↕Select    [↔]Confirm</p>

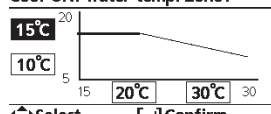

Menu	Default Setting	Setting Options / Display
	<b>&gt; Heater ON/OFF &gt; Delay time for heater ON</b>	
0:30 min	Delay time for heater to turn on	Operation setup 10:34am, Mon Heater ON: Delay time Range: (0:10~1:00) Steps: $\pm 0:10$ <b>0:30</b> ↕Select [-] Confirm
	<b>&gt; Heater ON/OFF &gt; Water temperature for heater ON</b>	
-4 °C	Setting of water temperature to turn on from water set temperature.	Operation setup 10:34am, Mon Heater ON: $\Delta T$ of target Temp. Range: (-10°C~-2°C) Steps: $\pm 1^\circ\text{C}$ <b>-4</b> °C ↕Select [-] Confirm
	<b>&gt; Heater ON/OFF &gt; Water temperature for heater OFF</b>	
-2 °C	Setting of water temperature to turn off from water set temperature.	Operation setup 10:34am, Mon Heater OFF: $\Delta T$ of target Temp. Range: (-8°C~0°C) Steps: $\pm 1^\circ\text{C}$ <b>-2</b> °C ↕Select [-] Confirm
<b>6.2</b>	<b>&gt; *1, *2 Cool</b>	
To set various water & ambient temperatures for cooling.	Water temperatures for cooling ON and $\Delta T$ for cooling ON.	Operation setup 10:34am, Mon <b>Cool</b> <b>Water temp. for cooling ON</b> $\Delta T$ for cooling ON ↕Select [-] Confirm
	<b>&gt; Water temp. for cooling ON</b>	
Compensation curve	Cooling ON temperatures in compensation curve or direct input.	Operation setup 10:34am, Mon Cool ON: Water temp. <b>Compensation curve</b> Direct ↕Select [-] Confirm
	<b>&gt; Water temp. for cooling ON &gt; Compensation curve</b>	
X axis: 20 °C, 30 °C Y axis: 15 °C, 10 °C	Input the 4 temperature points (2 on horizontal X axis, 2 on vertical Y axis)	Cool ON: Water temp: Zone1  ↕Select [-] Confirm
	<ul style="list-style-type: none"> <li>• If 2 zone system is selected, the 4 temperature points must also be input for Zone 2.</li> <li>• "Zone 1" and "Zone 2" will not appear on the display if only 1 zone system.</li> </ul>	

\*1 The system is locked to operate without COOL mode. It can be unlocked only by authorised installers or our authorised service partners.

\*2 Only displayed when COOL mode is unlocked (This means when COOL mode is available).

Menu	Default Setting	Setting Options / Display
		<p>&gt; <b>Water temp. for cooling ON &gt; Direct</b></p> <p>10 °C      Set temperature for Cooling ON      <b>Operation setup</b> 10:34am, Mon Cool ON: Water temp.: Zone2 Range: (5°C-20°C)      <b>10</b> °C Steps: ±1°C ↕Select      [-] Confirm</p> <p>• If 2 zone system is selected, temperature set point must input for Zone 2. • "Zone 1" and "Zone 2" will not appear on the display if only 1 zone system.</p> <p>&gt; <b>ΔT for cooling ON</b></p> <p>5 °C      Set ΔT for cooling ON * This setting will not available to set when pump flowrate set to Max. duty.      <b>Operation setup</b> 10:34am, Mon Cool ON: ΔT Range: (1°C-15°C)      <b>5</b> °C Steps: ±1°C ↕Select      [-] Confirm</p>
<b>6.3</b>	> *1, *2 Auto	
Automatic switch from Heat to Cool or Cool to Heat.	Outdoor temperatures for switching from Heat to Cool or Cool to Heat.	<p><b>Operation setup</b> 10:34am, Mon Auto Outdoor temp. for (Heat to Cool) Outdoor temp. for (Cool to Heat) ↕Select      [-] Confirm</p> <p>&gt; <b>Outdoor temp. for (Heat to Cool)</b></p> <p>15 °C      Set outdoor temperature for switching from Heat to Cool.      <b>Operation setup</b> 10:34am, Mon Auto: Outdoor temp.(Heat to Cool) Range: (11°C-25°C)      <b>15</b> °C Steps: ±1°C ↕Select      [-] Confirm</p> <p>&gt; <b>Outdoor temp. for (Cool to Heat)</b></p> <p>10 °C      Set outdoor temperature for switching from Cool to Heat.      <b>Operation setup</b> 10:34am, Mon Auto: Outdoor temp.(Cool to Heat) Range: (5°C-14°C)      <b>10</b> °C Steps: ±1°C ↕Select      [-] Confirm</p>
<b>6.4</b>	> Tank	
Setting functions for the tank.	Floor operation time (max) / Tank heat up time (max) / Tank re-heat temp. / Sterilization	<p><b>Operation setup</b> 10:34am, Mon Tank Floor operation time (max) Tank heat up time (max) Tank re-heat temp. ↕Select      [-] Confirm</p> <p>• The display will show 3 functions at a time.</p> <p>&gt; <b>Floor operation time (max)</b></p> <p>8:00      Maximum time for floor operation (in hours and minutes)      <b>Operation setup</b> 10:34am, Mon Tank: Floor ope. time (max) Range: (0:30-10:00) Steps: ±0:30      <b>8:00</b> ↕Select      [-] Confirm</p>

\*1 The system is locked to operate without COOL mode. It can be unlocked only by authorised installers or our authorised service partners.

\*2 Only displayed when COOL mode is unlocked (This means when COOL mode is available).

Menu	Default Setting	Setting Options / Display														
<b>&gt; Tank heat up time (max)</b>																
1:00	Maximum time for heating the tank (in hours and minutes)	Operation setup 10:34am, Mon Tank: Heat up time (max) Range: (0:05~4:00) Steps: ±0:05 <b>1:00</b> ↕ Select    [↔] Confirm														
<b>&gt; Tank re-heat temp.</b>																
-8 °C	Set temperature to perform reboil of tank water.	Operation setup 10:34am, Mon Tank: Re-heat temp. Range: (-12°C~-2°C) Steps: ±1°C <b>-8</b> °C ↕ Select    [↔] Confirm														
<b>&gt; Sterilization</b>																
Monday	Sterilization may be set for 1 or more days of the week.  Sun / Mon / Tue / Wed / Thu / Fri / Sat	Operation setup 10:34am, Mon Sterilization: Day <table border="1"> <tr> <td>Sun</td> <td>Mon</td> <td>Tue</td> <td>Wed</td> <td>Thu</td> <td>Fri</td> <td>Sat</td> </tr> <tr> <td>—</td> <td>✓</td> <td>—</td> <td>—</td> <td>—</td> <td>—</td> <td>—</td> </tr> </table> ↕ Day    ↕ [☑]/[☐]    [↔] Confirm	Sun	Mon	Tue	Wed	Thu	Fri	Sat	—	✓	—	—	—	—	—
Sun	Mon	Tue	Wed	Thu	Fri	Sat										
—	✓	—	—	—	—	—										
<b>&gt; Sterilization: Time</b>																
12:00	Time of the selected day(s) of the week to sterilize the tank  0:00 ~ 23:59	Operation setup 10:34am, Mon Sterilization: Time <b>12:00</b> pm ↕ Select    [↔] Confirm														
<b>&gt; Sterilization: Boiling temp.</b>																
65 °C	Set boiling temperatures for sterilize the tank.	Operation setup 10:34am, Mon Sterilization: Boiling temp. Range: (55°C~65°C) Steps: ±1°C <b>65</b> °C ↕ Select    [↔] Confirm														
<b>&gt; Sterilization: Ope. time (max)</b>																
0:10	Set sterilizing time (in hours and minutes)	Operation setup 10:34am, Mon Sterilization: Ope. time (max) Range: (0:05~1:00) Steps: ±0:05 <b>0:10</b> ↕ Select    [↔] Confirm														

## 7 Installer setup > Service setup

### 7.1 > Pump maximum speed

To set the maximum speed of the pump.	Setting the flow rate, max. duty and operation ON/OFF of the pump.  Flow rate: XX.X L/min Max. Duty: 0x40 ~ 0xFE, Pump: ON/OFF/Air Purge	Service setup 10:34am, Mon Flow rate    Max. Duty    Operation 0.0 L/min    0xCE <b>Air Purge</b> ← Select
---------------------------------------	--	---

Menu	Default Setting	Setting Options / Display
<b>7.2 &gt; Pump down</b>		
To set the pump down operation.	Pump down operation  ON	Service setup 10:34am, Mon Pump down operation in progress! [OFF]
<b>7.3 &gt; Dry concrete</b>		
To dry the concrete (floor, walls, etc.) during construction.  Do not use this menu for any other purposes and in period other than during construction	Edit to set the temperature of dry concrete.  ON / Edit	Service setup 10:34am, Mon Dry concrete ON Edit Select [Confirm]
	<b>&gt; Edit</b>	
	Stages: 1 Temperature: 25 °C	Heating temperature for drying the concrete. Select the desired stages: 1 ~ 10, range: 1 ~ 99 Service setup 10:34am, Mon Dry concrete: 1/10 Range: (25°C-55°C) Steps: ±1°C 25 °C Select [Confirm]
	<b>&gt; ON</b>	
	Confirm the setting temperatures of dry concrete for each stage.	Service setup 10:34am, Mon Dry concrete: Status Stage : 1/10 Water set temp. : 25°C Actual water temp. : 25°C/25°C [OFF]
<b>7.4 &gt; Service contact</b>		
To set up to 2 contact names and numbers for the User.	Service engineer's name and contact number.  Contact 1 / Contact 2	Service setup 10:34am, Mon Service contact: Contact 1 Contact 2 Select [Confirm]
	<b>&gt; Contact 1 / Contact 2</b>	
	Contact name or number.	Service contact 10:34am, Mon Contact 1 Name : Bryan Adams Phone icon : 08812345678 Select [Edit]
	Name / phone icon	
	Input name and number	Contact-1 ABC/abc 0-9/Other ABCDEFGHIJKL MNOPQR Space STUVWXYZ abcdefghi BS jklmnopqrstuvwxy Conf Select [Enter]
	Contact name: alphabet a ~ z. Contact number: 1 ~ 9	Number: 1 2 3 ( ) 4 5 6 ) 7 8 9 - BS * 0 # _ Conf Select [Enter]

## 5.1.6 Main Components

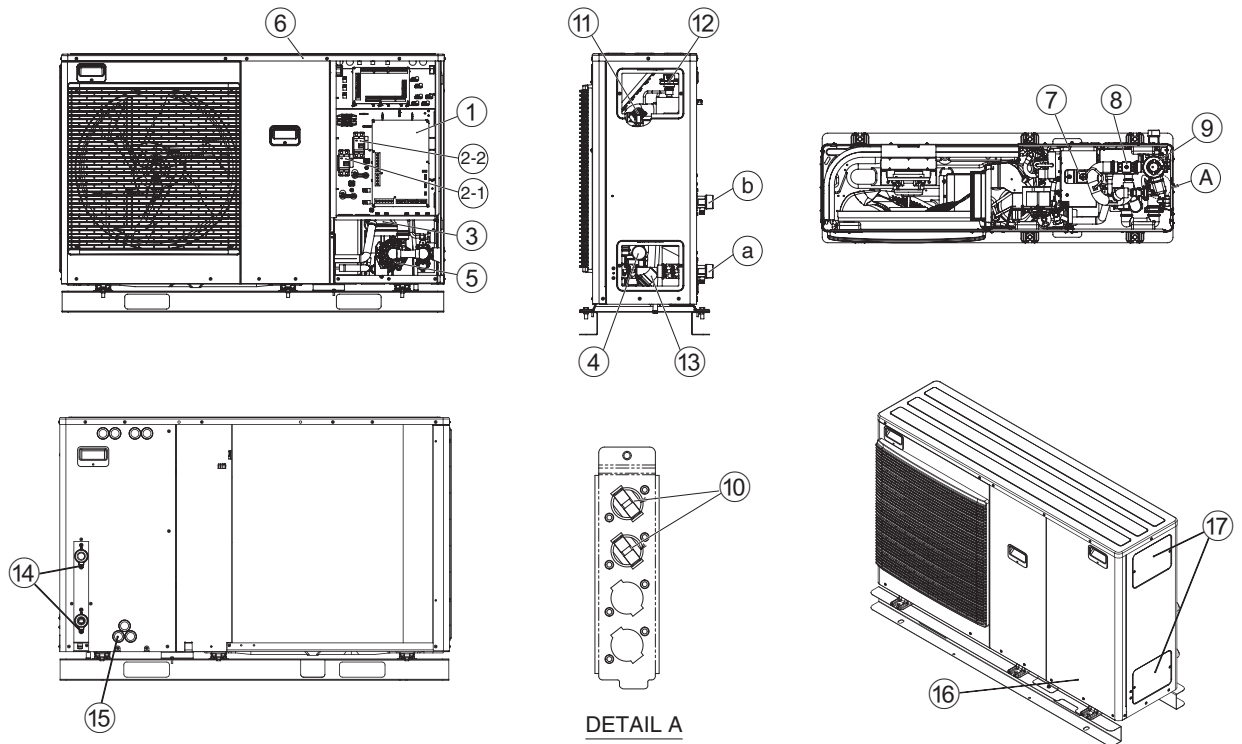

### Component name

- |                                       |                                 |
|---------------------------------------|---------------------------------|
| ① PCB                                 | ⑩ Overload Protector (2 pieces) |
| ②-① Single phase RCCB (Main Power)    | ⑪ Pressure Relief Valve         |
| ②-② Single phase RCCB (Backup Heater) | ⑫ Air Purge Valve               |
| ③ Heat Exchanger                      | ⑬ Magnetic Water Filter Set     |
| ④ Water Pressure Gauge                | ⑭ Plug (2 pieces)               |
| ⑤ Water Pump                          | ⑮ Bushing (7 pieces)            |
| ⑥ Cabinet Top Plate                   | ⑯ Cabinet Front Plate           |
| ⑦ Expansion Vessel                    | ⑰ Cover (2 pieces)              |
| ⑧ Flow Sensor                         |                                 |
| ⑨ Heater Assembly                     |                                 |

### Connector name

- Ⓐ Water inlet
- Ⓑ Water outlet

It is advisable to avoid more than 2 blockage directions. For better ventilation & multiple-outdoor installation, please consult authorized dealer/specialist.

## 6. Dimensions

### 6.1 Mono Bloc Unit

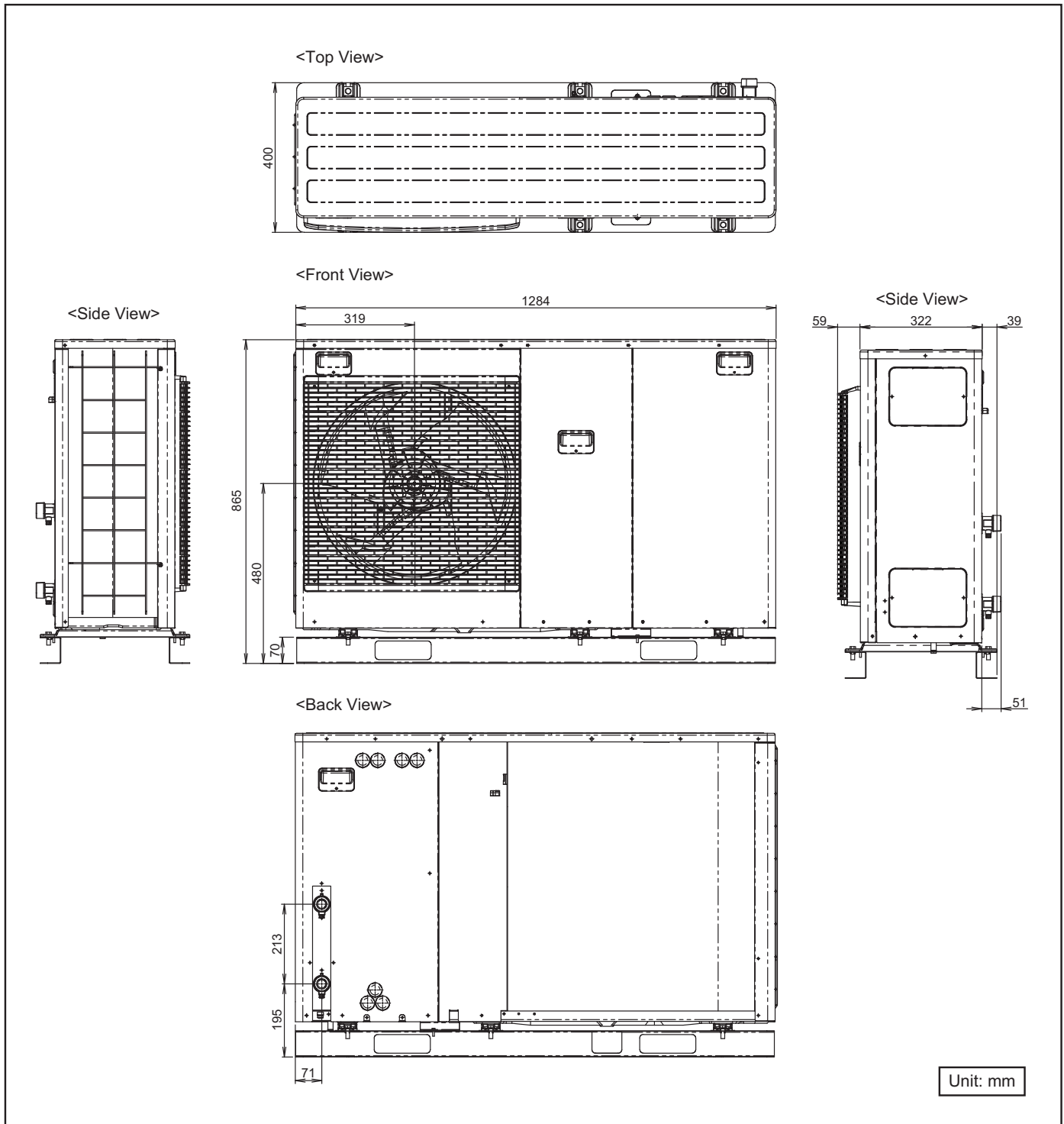

# 7. Refrigeration and Water Cycle Diagram

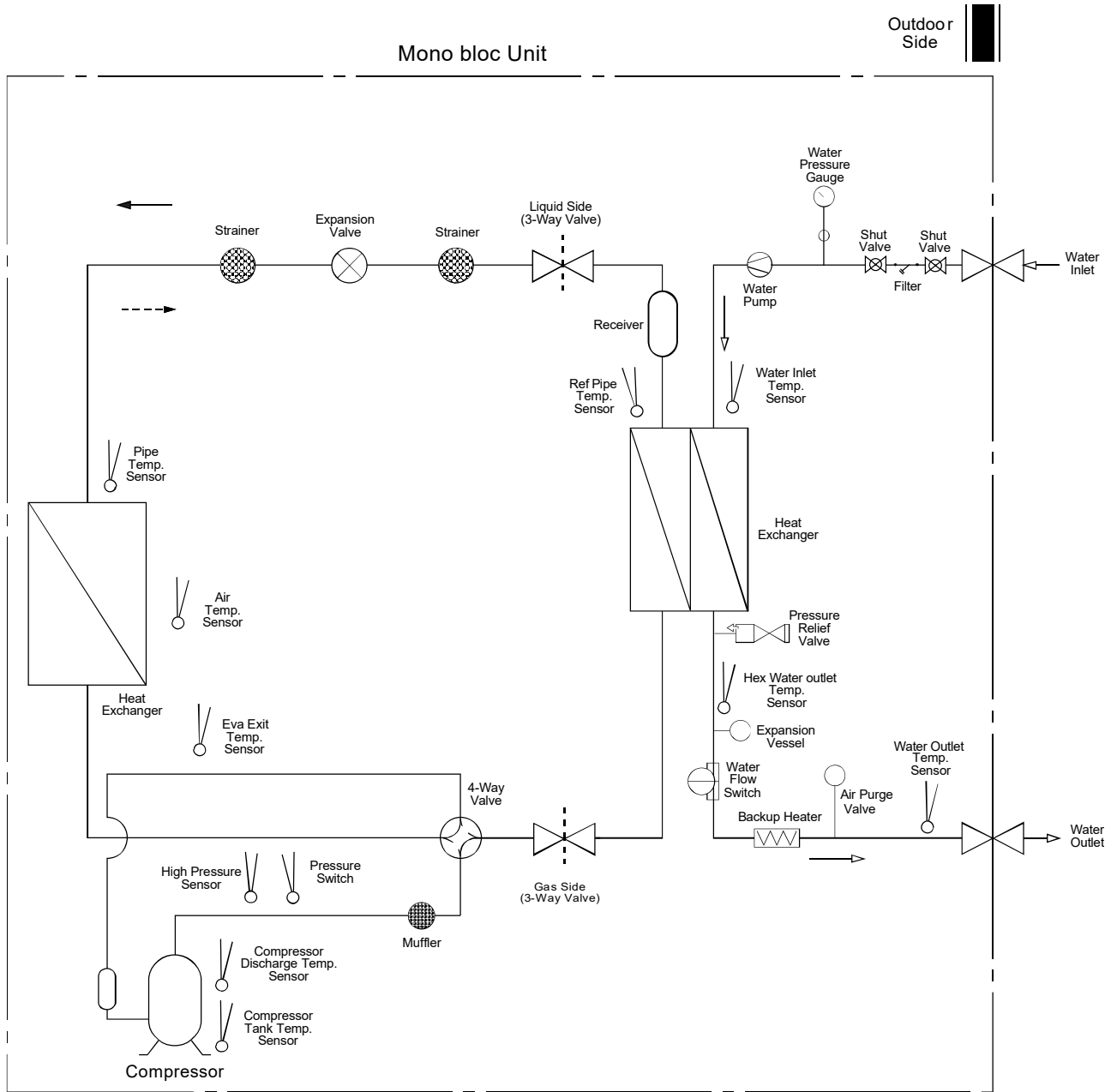

- Refrigerant Cycle (Heating)
- Water Cycle
- - - -> Refrigerant Cycle (Cooling)

## 7.1 Standard System (Optional PCB not connected)

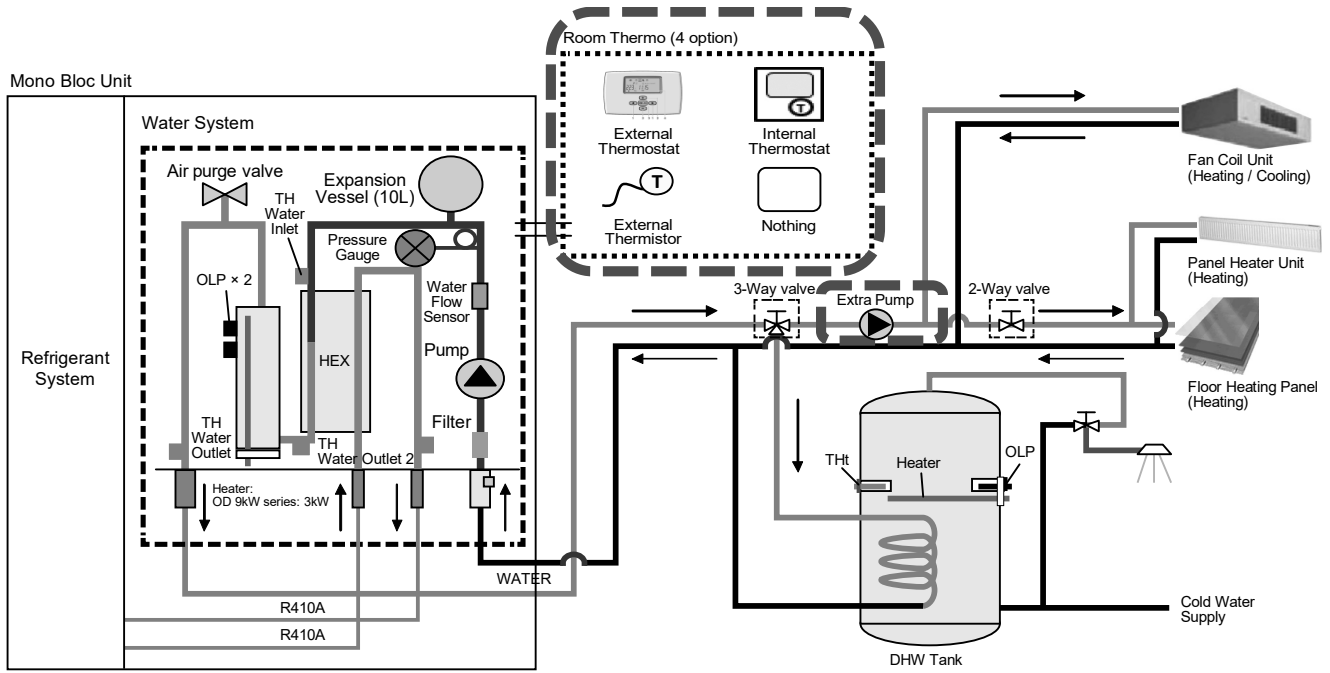

## 7.2 Advance System (Optional PCB connected)

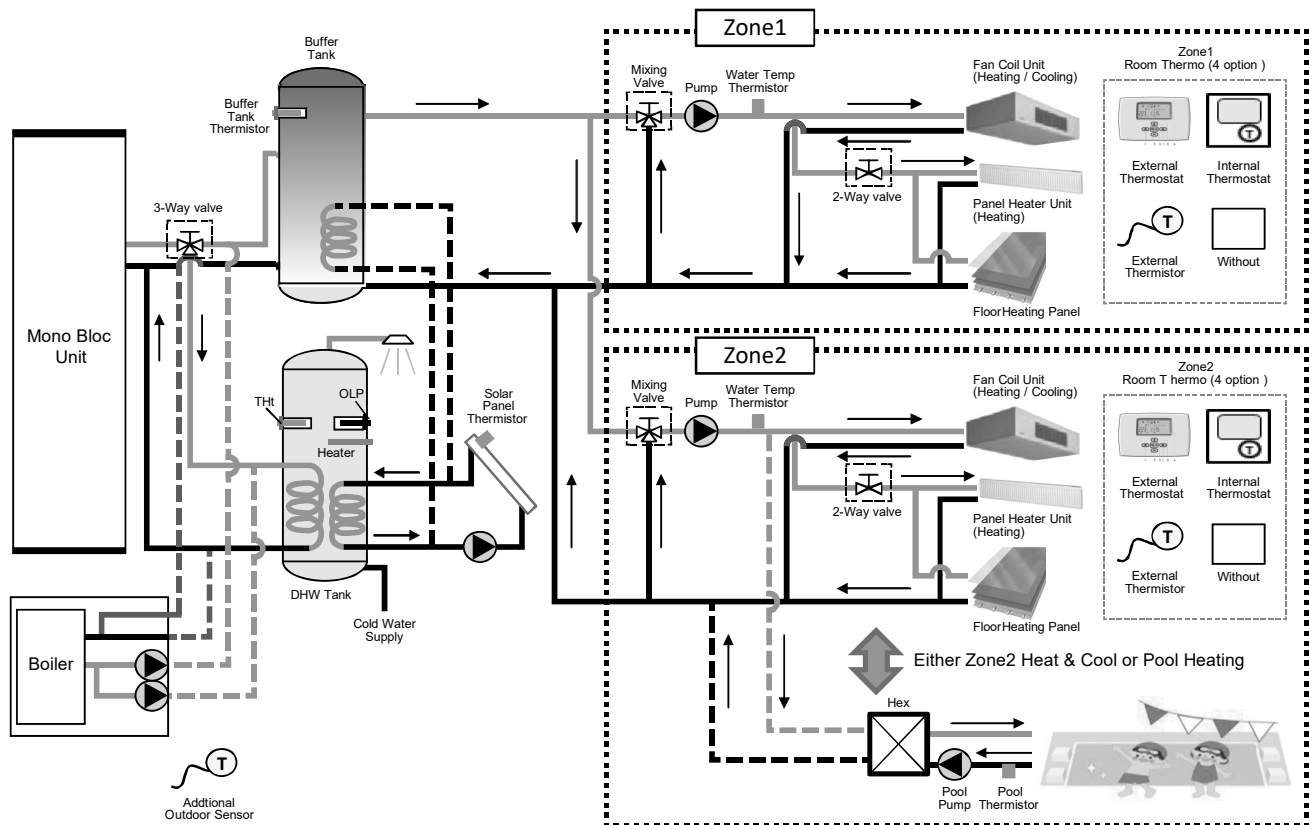



# 8. Block Diagram

## 8.1 WH-MDC05J3E5

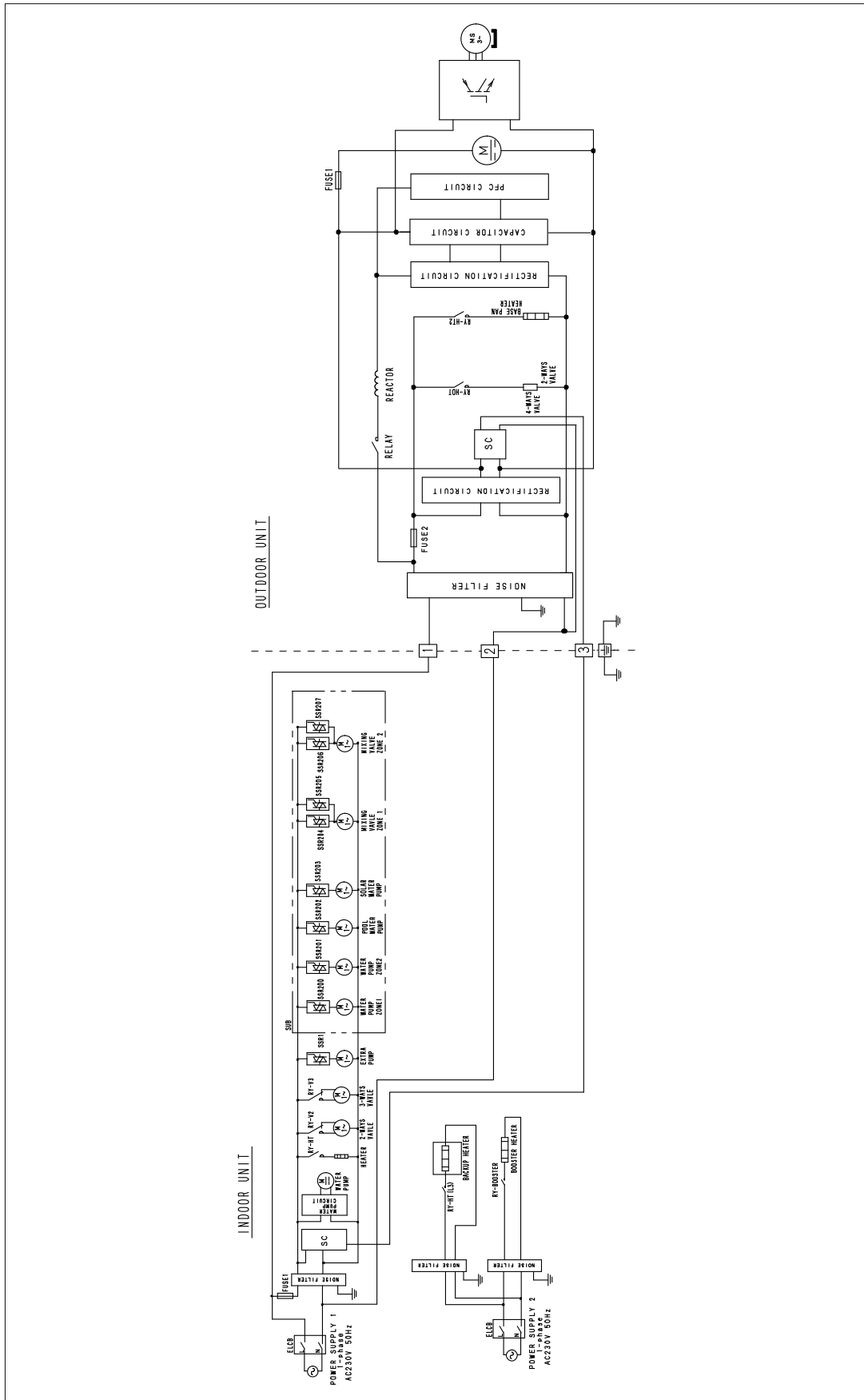

## 8.2 WH-MDC07J3E5 WH-MDC09J3E5

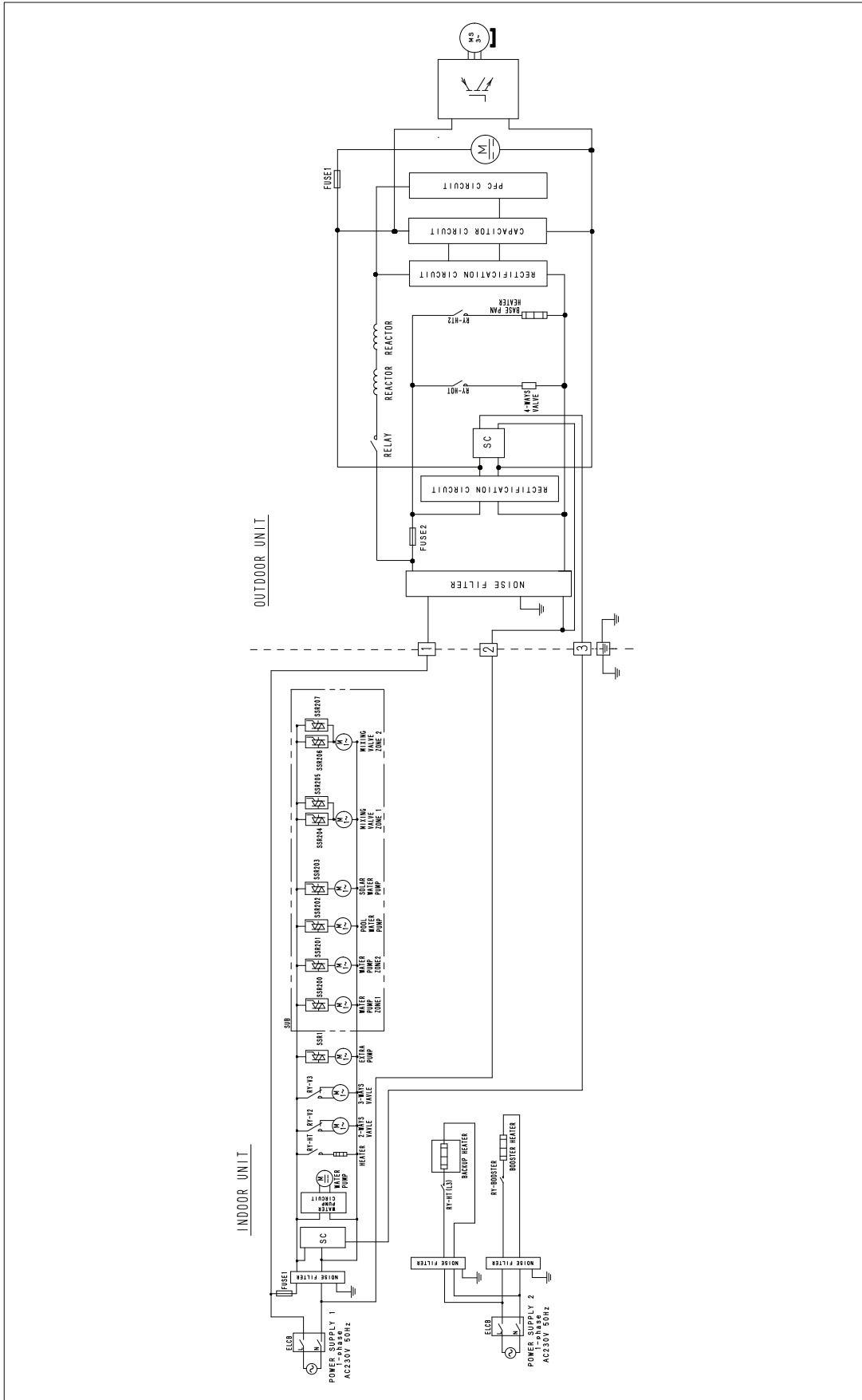

# 9. Wiring Connection Diagram

## 9.1 Water System

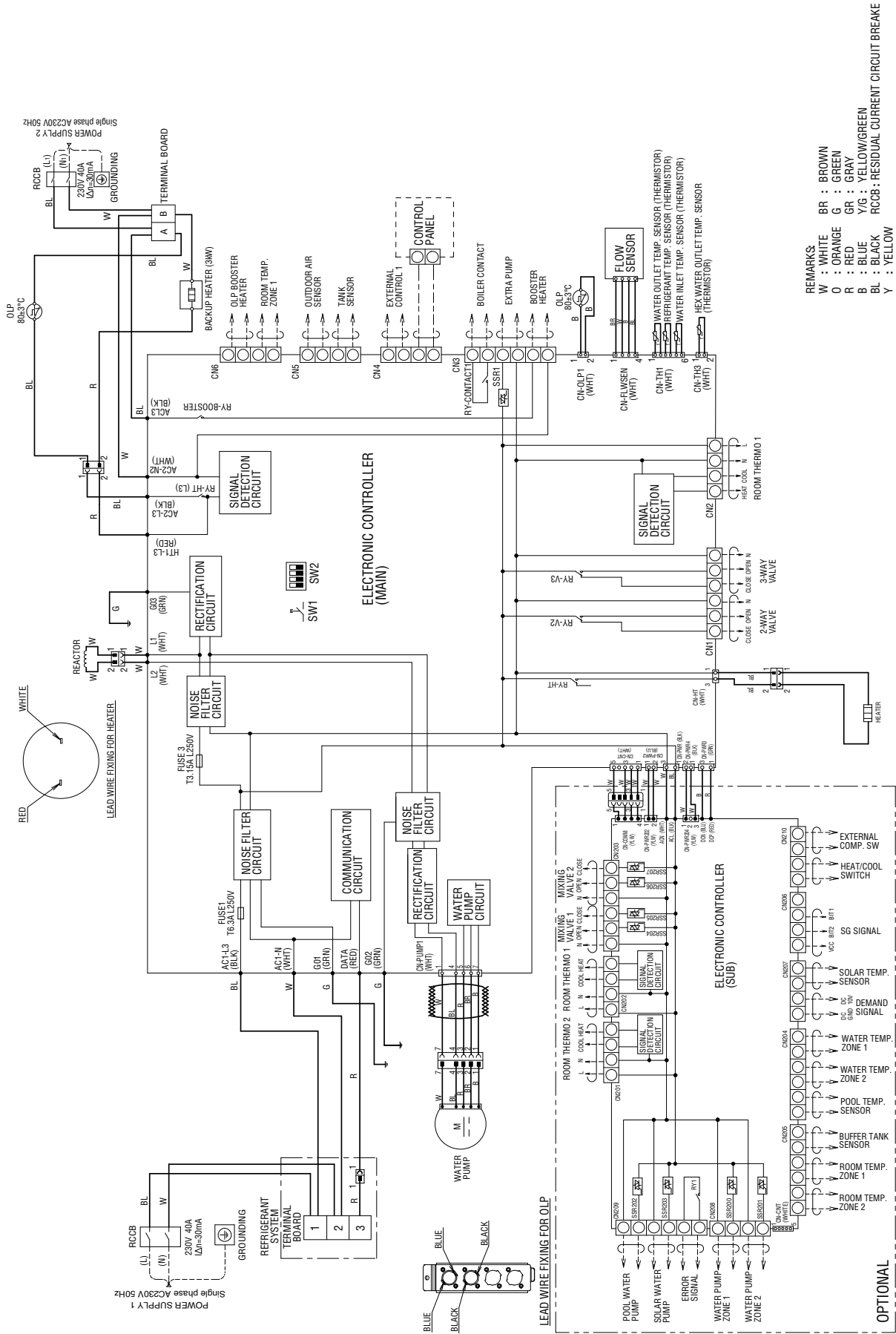

## 9.2 Refrigerant System

### 9.2.1 WH-MDC05J3E5

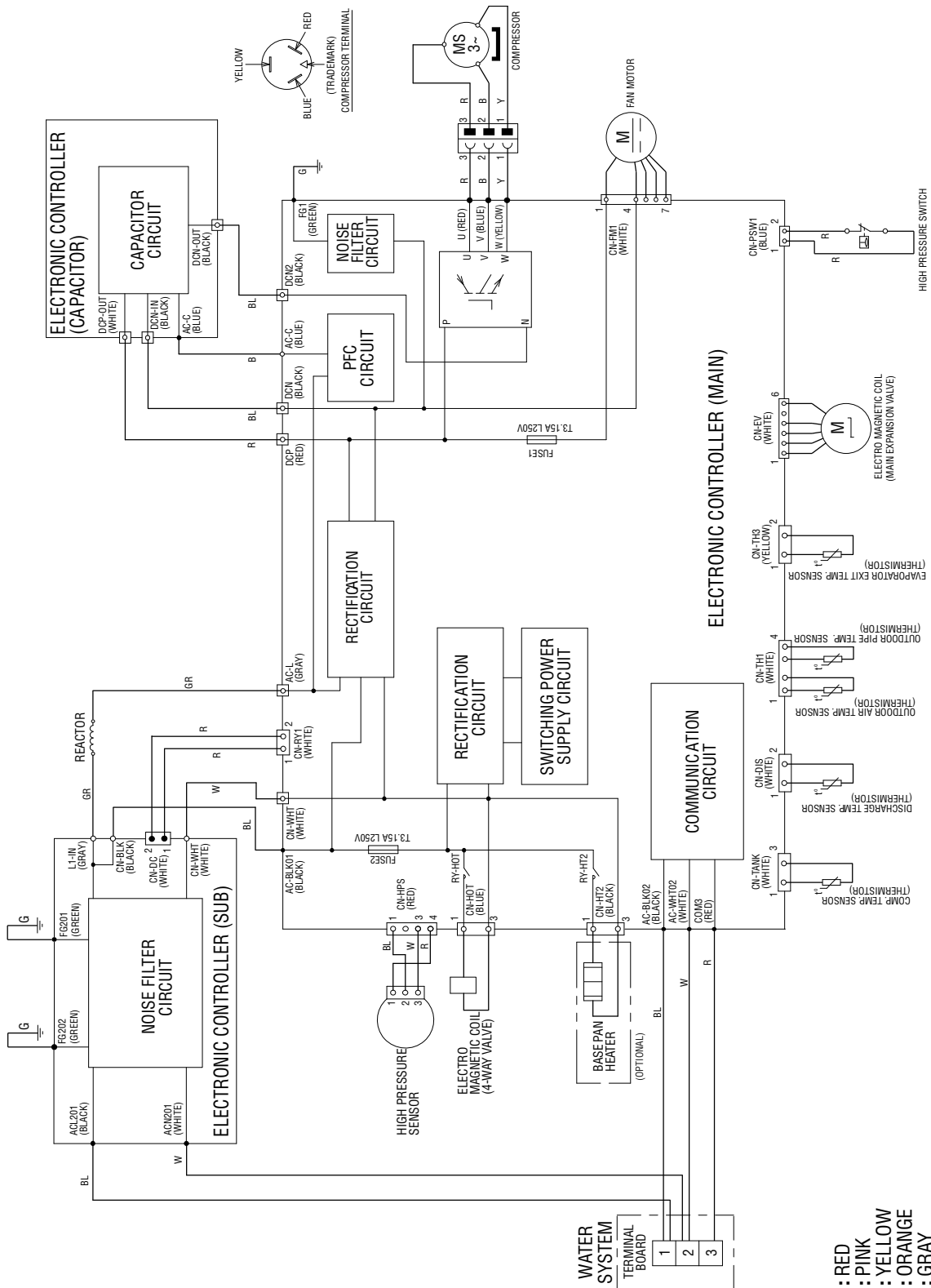

REMARKS:  
W : WHITE  
B : BLUE  
BL : BLACK  
BR : BROWN  
G : GREEN  
Y/G : YELLOW/GREEN  
R : RED  
P : PINK  
Y : YELLOW  
O : ORANGE  
GR : GRAY

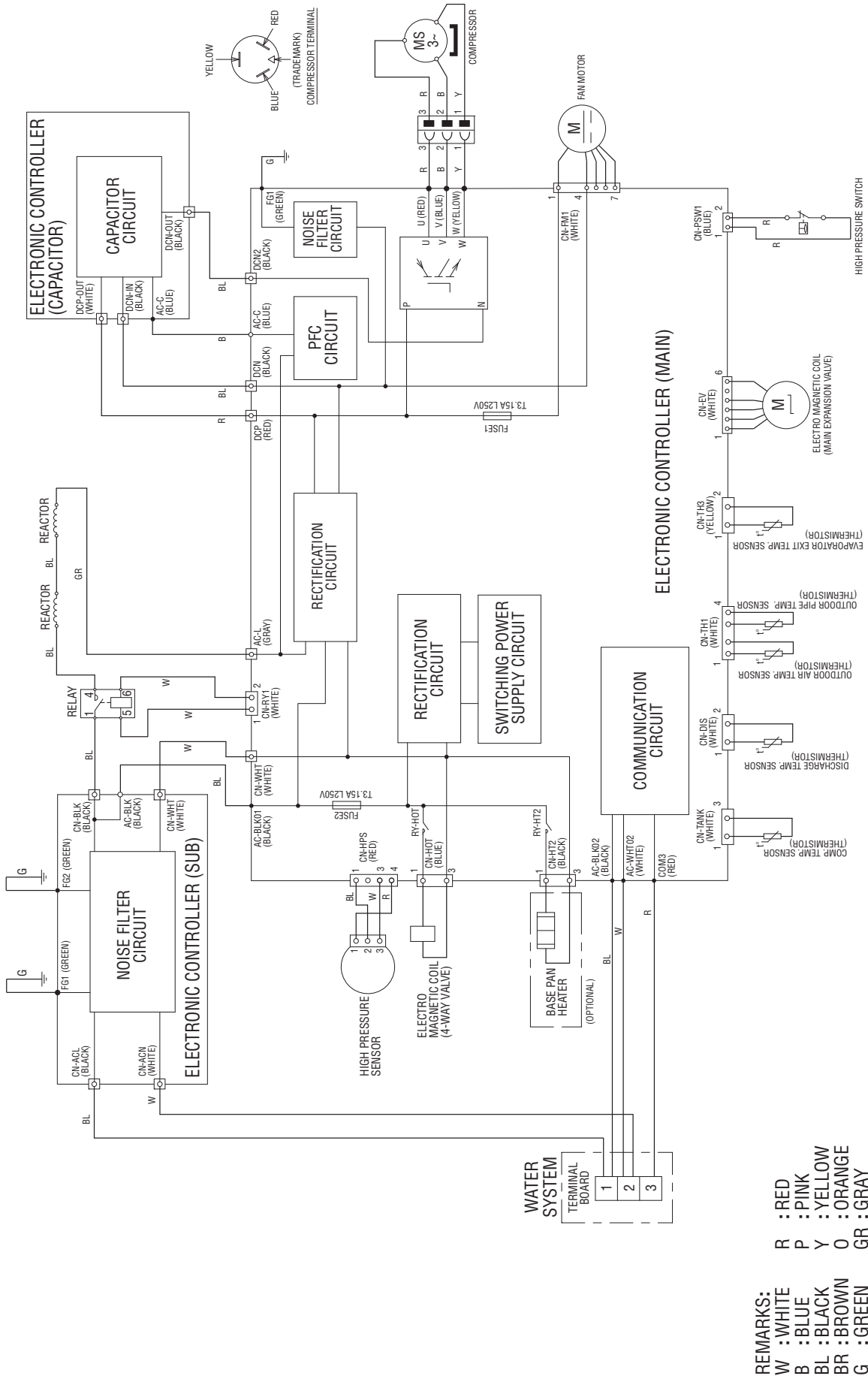

- REMARKS:
- W : WHITE
  - B : BLUE
  - BL : BLACK
  - BR : BROWN
  - G : GREEN
  - Y/G : YELLOW/GREEN
  - R : RED
  - P : PINK
  - Y : YELLOW
  - O : ORANGE
  - GR : GRAY



# 10.2 Refrigerant System

## 10.2.1 WH-MDC05J3E5

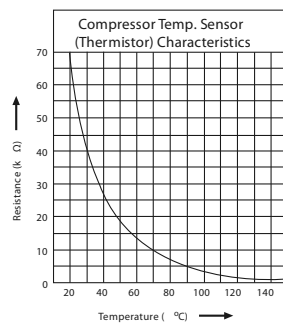
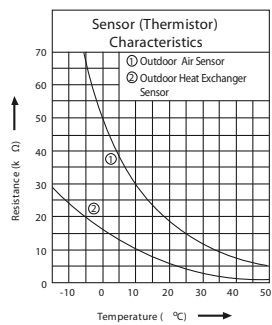
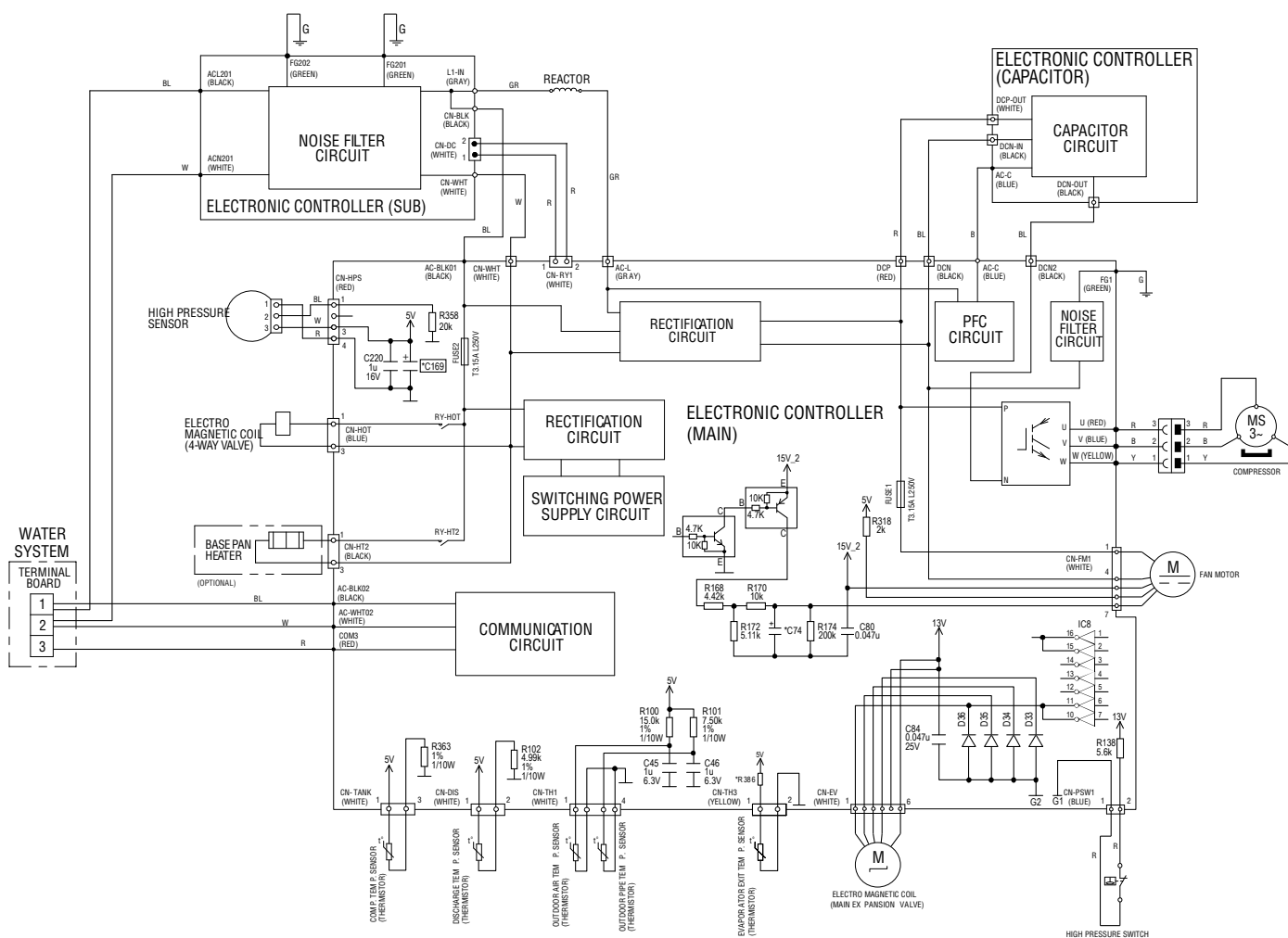

# 10.2.2 WH-MDC07J3E5 WH-MDC09J3E5

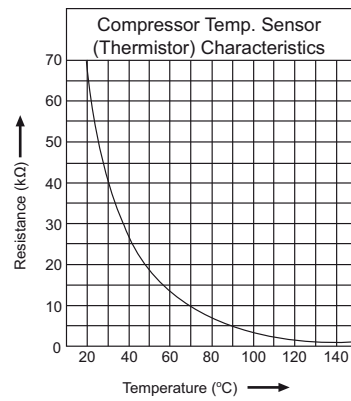
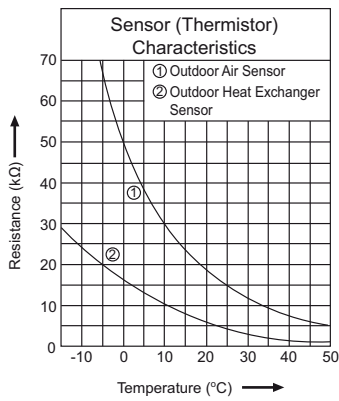
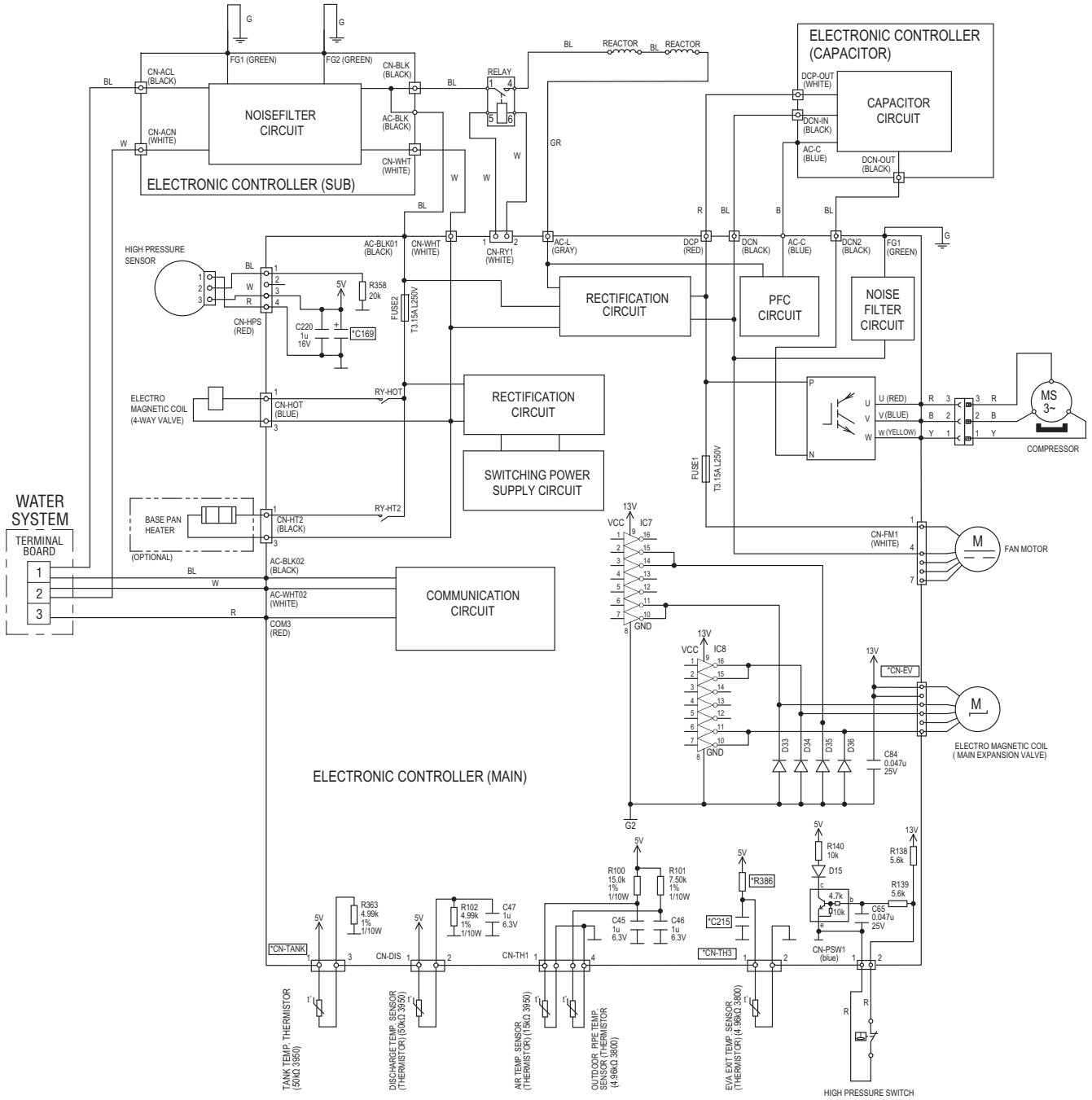



# 11. Printed Circuit Board

## 11.1 Water System

### 11.1.1 Main Printed Circuit Board

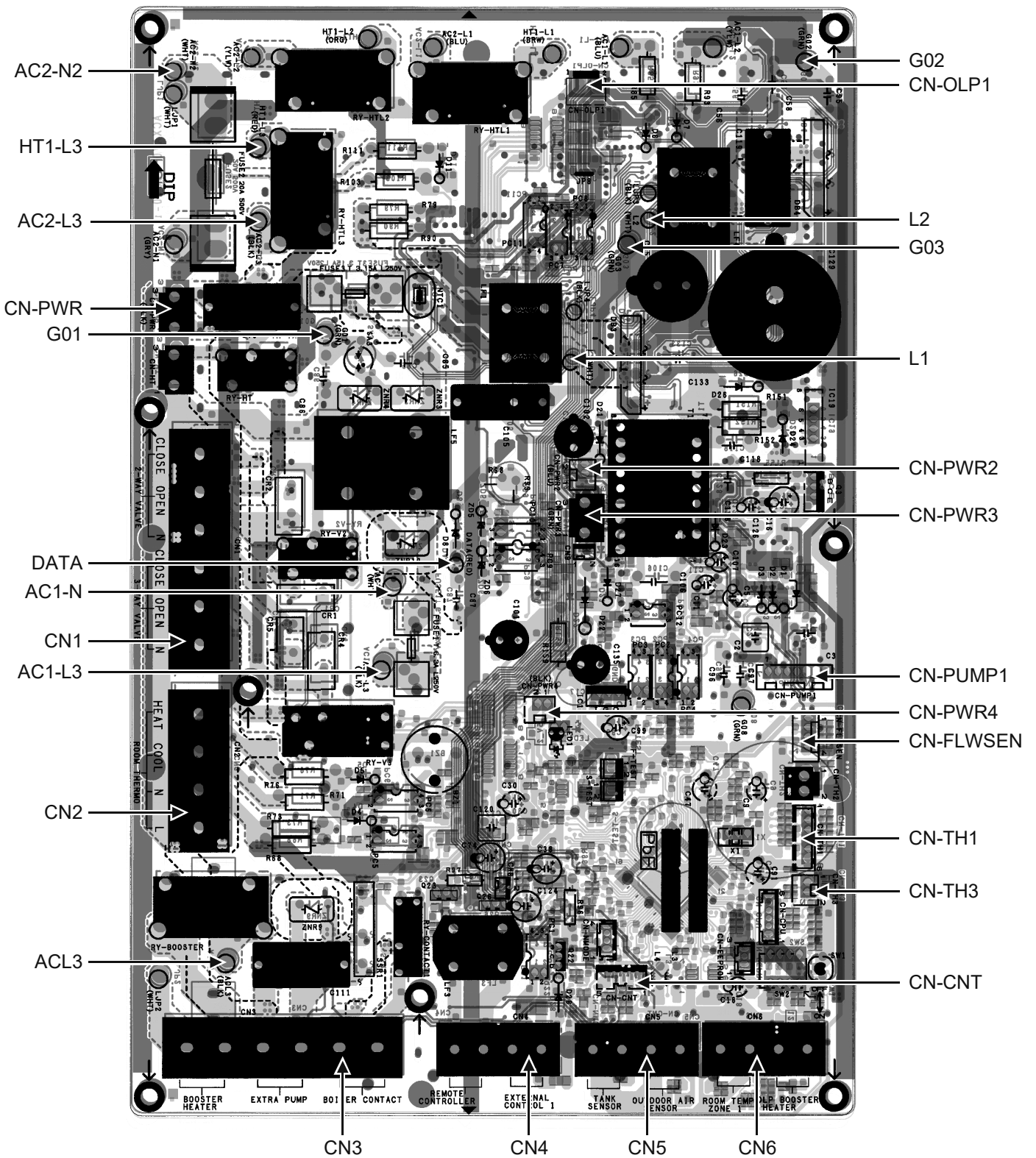

## 11.1.2 Optional Printed Circuit Board

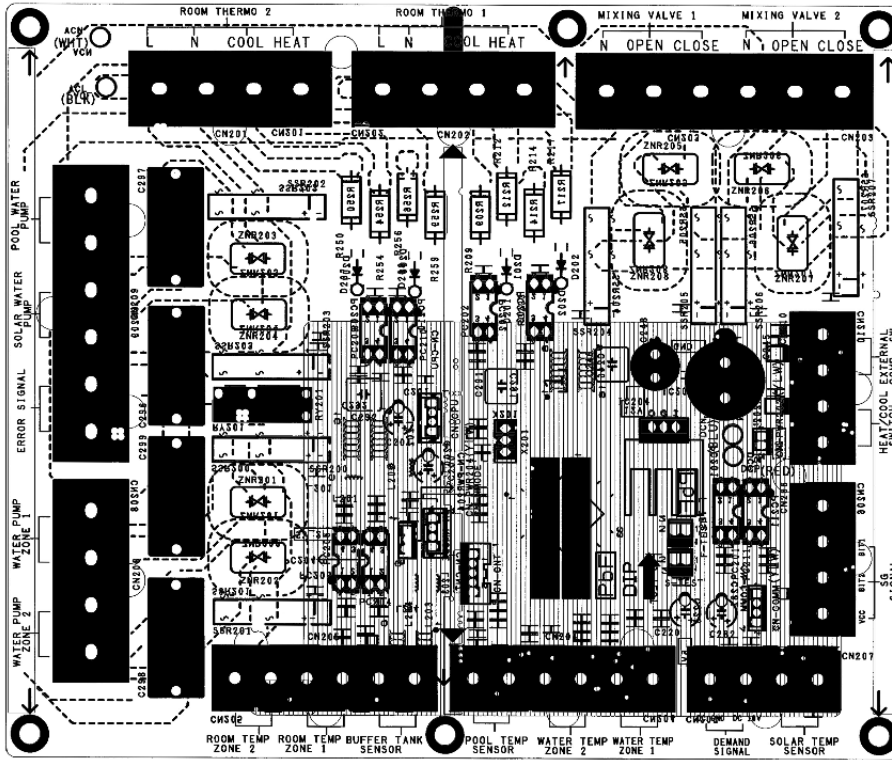

## 11.2 Refrigerant System

### 11.2.1 Main Printed Circuit Board

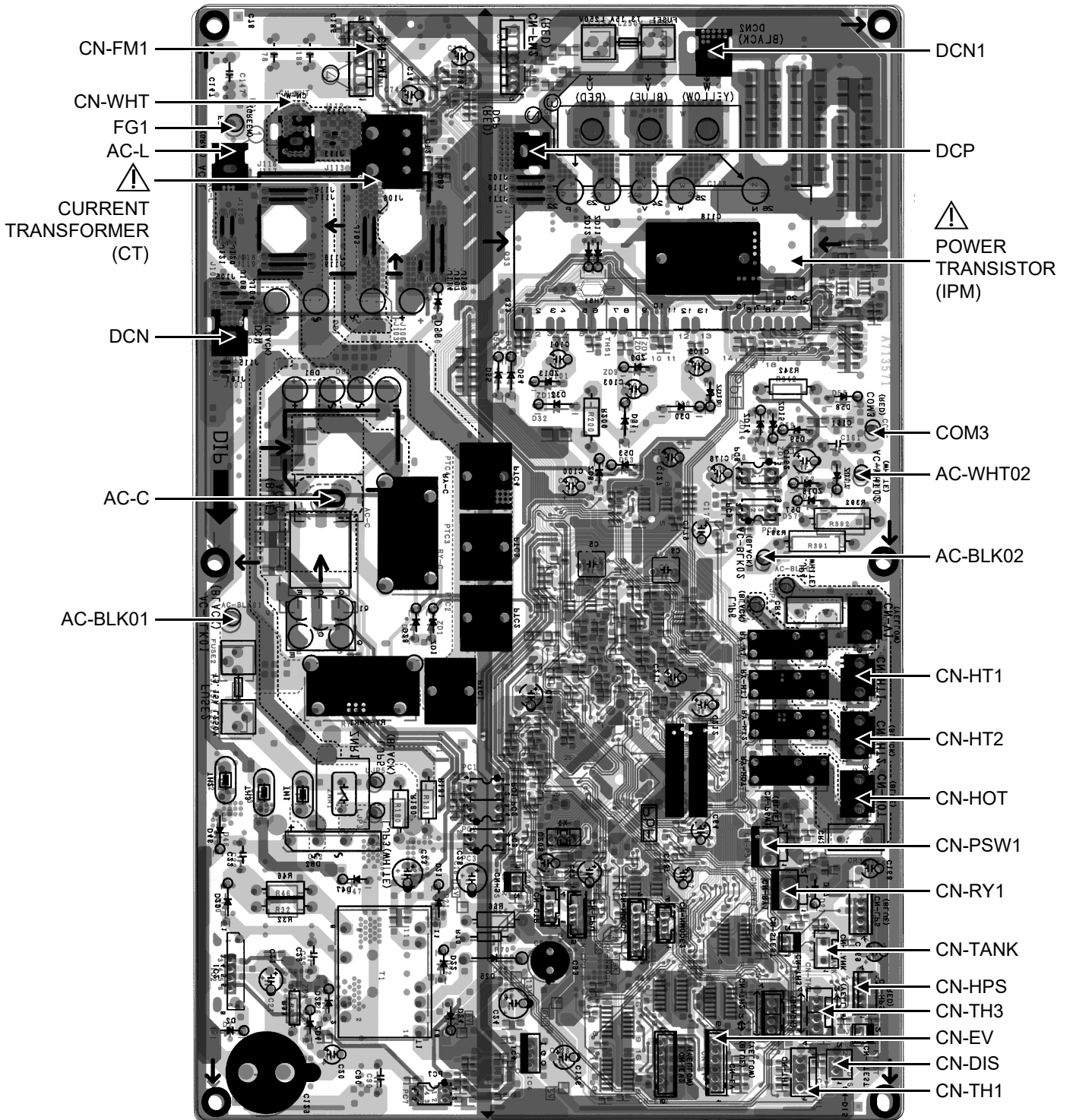

## 12. Installation Instruction

### 12.1 Mono Bloc Unit

#### 12.1.1 Select the Best Location

- Install the Mono bloc unit in outdoor locations only.
- Avoid installations in areas where the ambient temperature may drop below  $-20^{\circ}\text{C}$ .
- The Mono bloc unit must be installed on a flat, solid surface.
- A place removed from any heat source or steam which may effect the operation of the Mono bloc unit.
- A place where air circulation is good.
- A place where drainage can be easily done.
- A place where Mono bloc unit's operation noise will not cause discomfort to the user.
- A place which is accessible for maintenance.
- Ensure to keep minimum distance of spaces as illustrated above from wall, ceiling, or other obstacles.
- A place where flammable gas leaking might not occur.
- A place where the Mono bloc unit's piping and wiring lengths come within reasonable ranges.
- If an awning is built over the unit to prevent direct sunlight or rain, be careful that heat radiation from the condenser is not obstructed.
- Do not place any obstacles which may cause a short circuit of the discharged air.
- Avoid installing the Mono bloc unit at a location where suction side may be exposed directly to wind.
- If Mono bloc unit installed near sea, region with high content of sulphur or oily location (e.g. machinery oil, etc.), its lifespan may be shorten.
- When installing the product in a place where it will be affected by typhoon or strong wind such as wind blowing between buildings, including the rooftop of a building and a place where there is no building in surroundings, fix the product with an overturn prevention wire, etc. (Overturn prevention fitting model number: K-KYZP15C)

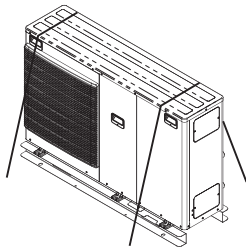

#### 12.1.2 Mono Bloc Unit Installation

Mono bloc unit will become heavy when filled with water. Please install the unit on a strong concrete floor and consider the weight of the unit and water.

- Fix Mono bloc unit on the concrete floor with M12 anchor bolt at 4 locations.
- Pull-out strength of these anchor bolts must be above 15000N.

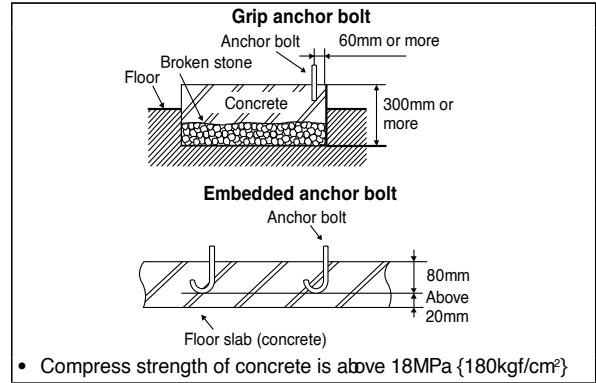
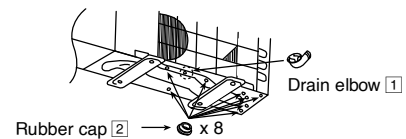

Illustration of grip type and embedded type anchor bolt

#### 12.1.2.1 Disposal of Mono Bloc Unit Drain Water

- When a Drain elbow is used, please ensure to follow below:
  - The unit should be placed on a stand which is taller than 50mm.
  - Cover the 8 holes ( $\varnothing 20\text{mm}$ ) with Rubber cap (refer to illustration below)
  - Use a tray (field supply) when necessary to dispose the Mono bloc unit drain water.



- If the unit is used in an area where temperature falls below  $0^{\circ}\text{C}$  for 2 or 3 consecutive days, it is recommended not to use the Drain elbow and Rubber cap, for the drain water freezes and the fan will not rotate.

## 12.1.3 Piping Installation



**WARNING**

This section is for authorized and licensed electrician / water system installer only. Work behind the front plate secured by screws must only be carried out under supervision of qualified contractor, installation engineer or service person.

### 12.1.3.1 Typical Piping Installation

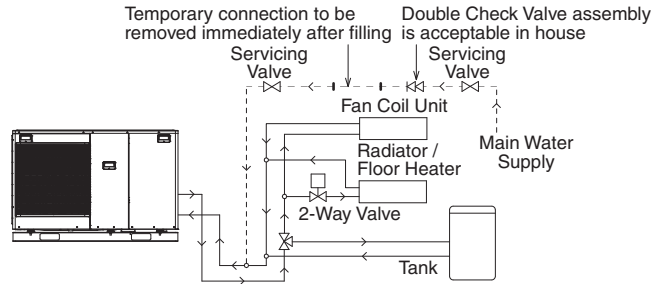

Please engage a licensed water circuit installer to install this water circuit.

- This water circuit must comply with relevant European and national regulations (including EN61770), and local building regulation codes.
- Ensure the components installed in the water circuit could withstand water pressure during operation.
- Do not apply excessive force to piping that may damage the pipes.
- Use Rp 1¼" nut for both water inlet and water outlet connection and clean all piping with tap water before connecting to the Mono bloc unit.
- Cover the pipe end to prevent dirt and dust when inserting it through a wall. If an existing tank is to be connected to this Mono bloc unit, ensure the pipes are clean before water pipe installation is carried out.
- Choose proper sealer which can withstand the pressures and temperatures of the system.
- Make sure to use two spanners to tighten the connection. Tighten the nuts with torque wrench: 117.6 N•m.
- If non-brass metallic piping is used for installation, make sure to insulate the piping to prevent galvanic corrosion.
- Do not use pipes that are crushed or deformed. If these inferior pipes are used, it may cause unit malfunction.
- Make sure to insulate the water circuit piping (insulator thickness : 20mm or more) to prevent condensation during cooling operation and reduction of heating capacity, as well as avoid freezing of the outdoor water circuit piping during winter season.
- After installation, check the water leakage condition in connection area during test run.
- In case of a power supply failure or pump operating failure, drain the system (as suggested in the figure below).

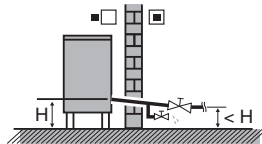

When water is idle inside the system, freezing up is very likely to happen which could damage the system.

### Drainage piping installation

- Use a drain hose with inner diameter of 15 mm.
- The hose must be installed in a continuously downward direction and left open to the frost-free atmosphere.
- If drain hose is long, use a metal support fixture along the way to eliminate the wavy pattern of drain tube.
- Water will drip from this hose, therefore the outlet of this hose must be installed in an area where the outlet cannot become blocked.
- Do not insert this hose into sewage or drain pipe that may generate ammonia gas, sulfuric gas, etc.
- If necessary, use a hose clamp to tighten the hose at drain hose connector to prevent it from leaking.



**CAUTION**

Do not over tighten, over tightening cause water leakage.

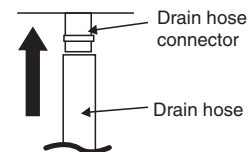

Illustration of how to fix drain hose to Mono bloc unit

## 12.1.4 Connect the Cable to Mono Bloc Unit



**WARNING**

This section is for authorised and licensed electrician only. Work behind the cabinet front plate secured by screws must only be carried out under supervision of qualified contractor, installation engineer or service person.

### 12.1.4.1 Remove The Cabinet Front Plate

1. Remove the 5 mounting screws as shown in the illustration.
2. Slide the Cabinet Front Plate downward to release the pawls.  
Then, pull it toward front to remove it.

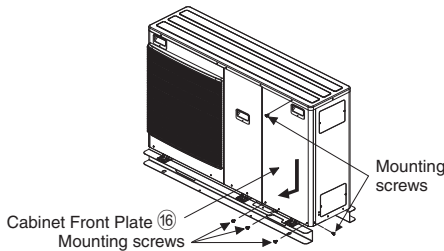

### 12.1.4.2 Remove The Cabinet Top Plate

1. Remove the 12 mounting screws as shown in the illustration.
2. Lift the Cabinet Top Plate upward to remove it.

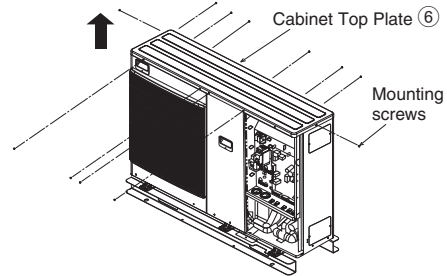

### 12.1.4.3 Fixing of Power Supply Cord

(REFER TO WIRING DIAGRAM AT UNIT FOR DETAIL)

1. An isolating device must be connected to the power supply cable.
  - o Isolating device (Disconnecting means) should have minimum 3.0 mm contact gap.
  - o Connect the approved polychloroprene sheathed power supply 1 cord and power supply 2 cord and type designation 60245 IEC 57 or heavier cord to the terminal board, and to the other end of the cord to isolating device (Disconnecting means). See below table for cable size requirement.

Model	Power Supply Cord	Cable Size	Isolating Devices	Recommended RCD
WH-MDC05J3E5	1	3 x min 1.5 mm <sup>2</sup>	15/16A	30mA, 2P, type A
	2	3 x min 1.5 mm <sup>2</sup>	15/16A	30mA, 2P, type AC
WH-MDC07J3E5 and WH-MDC09J3E5	1	3 x min 2.5 mm <sup>2</sup>	25A	30mA, 2P, type A
	2	3 x min 1.5 mm <sup>2</sup>	15/16A	30mA, 2P, type AC

2. To avoid the cable and cord being damaged by sharp edges, the cable and cord must be passed through the designated holes before being connected to the terminal block.
3. Secure the cable onto the control board with the holder (clammer).

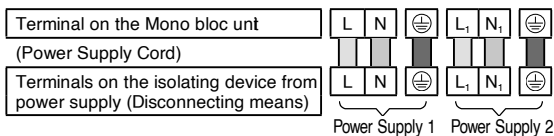

### 12.1.4.4 Wire Stripping and Connecting Requirement

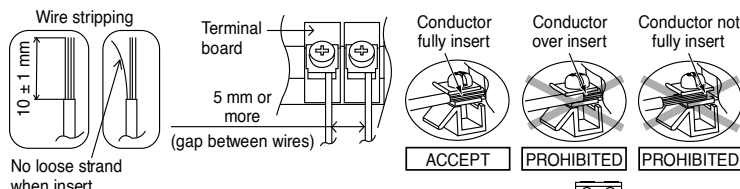

Terminal screw	Tightening torque cN·m {kg·cm}
M4	157~196 {16~20}
M5	196~245 {20~25}

\*1 - Earth wire must be longer than other cables for safety reasons.

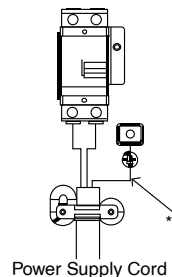

### 12.1.4.5 Connecting Requirement

For WH-MDC05J3E5

- The equipment's Power Supply 1 complies with IEC/EN 61000-3-2.
- The equipment's Power Supply 1 complies with IEC/EN 61000-3-3 and can be connected to current supply network.
- The equipment's Power Supply 2 complies with IEC/EN 61000-3-2.
- The equipment's Power Supply 2 complies with IEC/EN 61000-3-11 and shall be connected to suitable supply network, with the following maximum permissible system impedance  $Z_{max} = 0.450 \text{ ohm } (\Omega)$  at the interface. Please liaise with supply authority to ensure that the Power Supply 2 is connected only to a supply of that impedance or less.

For WH-MDC07J3E5 and WH-MDC09J3E5

- This equipment's Power Supply 1 complies with IEC/EN 61000-3-12.
- The equipment's Power Supply 1 complies with IEC/EN 61000-3-11 and shall be connected to a suitable supply network, having services current capacity  $\geq 100\text{A}$  per phase. Please liaise with supply authority that the service current capacity at the interface point is sufficient for the installation of the equipment.
- The equipment's Power Supply 2 complies with IEC/EN 61000-3-2.
- The equipment's Power Supply 2 complies with IEC/EN 61000-3-11 and shall be connected to suitable supply network, with the following maximum permissible system impedance  $Z_{max} = 0.450 \text{ ohm } (\Omega)$  at the interface. Please liaise with supply authority to ensure that the Power Supply 2 is connected only to a supply of that impedance or less.

### 12.1.4.6 Connecting with external device (optional)

- **All connections shall** follow to the local national wiring standard.
- It is strongly recommended to use manufacturer-recommended parts and accessories for installation.
- For connection to main PCB
  - 1 Two-way valve shall be spring and electronic type, refer to "Field Supply Accessories" table for details. Valve cable shall be (3 x min 1.5 mm<sup>2</sup>), of type designation 60245 IEC 57 or heavier, or similarly double insulation sheathed cable.
    - \* note: - Two-way Valve shall be CE marking compliance component.
    - Maximum load for the valve is 9.8VA.
  - 2 Three-way valve shall be spring and electronic type. Valve cable shall be (3 x min 1.5 mm<sup>2</sup>), of type designation 60245 IEC 57 or heavier, or similarly double insulation sheathed cable.
    - \* note: - Shall be CE marking compliance component.
    - It shall be directed to heating mode when it is OFF.
    - Maximum load for the valve is 9.8VA.
  - 3 Room thermostat cable must be (4 or 3 x min 0.5 mm<sup>2</sup>), of type designation 60245 IEC 57 or heavier cord, or similarly double insulation sheathed cable.
  - 4 Maximum output power of booster heater shall be  $\leq 3 \text{ kW}$ . Booster heater cable must be (3 x min 1.5 mm<sup>2</sup>), of type designation 60245 IEC 57 or heavier.
  - 5 Extra pump cable shall be (2 x min 1.5 mm<sup>2</sup>), of type designation 60245 IEC 57 or heavier.
  - 6 Boiler contact cable shall be (2 x min 0.5 mm<sup>2</sup>), of type designation 60245 IEC 57 or heavier.
  - 7 External control shall be connected to 1-pole switch with min 3.0 mm contact gap. Its cable must be (2 x min 0.5 mm<sup>2</sup>), double insulation layer of PVC-sheathed or rubber-sheathed cable.
    - \* note: - Switch used shall be CE compliance component.
    - Maximum operating current shall be less than  $3A_{rms}$ .
  - 8 Tank sensor shall be resistance type, please refer to graph below for the characteristic and details of sensor. Its cable shall be (2 x min 0.3 mm<sup>2</sup>), double insulation layer (with insulation strength of min 30V) of PVC-sheathed or rubber-sheathed cable.

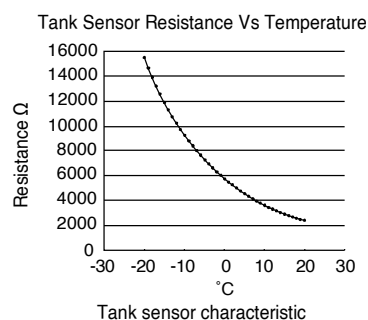

- 9 Room sensor zone 1 cable shall be (2 x min 0.3 mm<sup>2</sup>) double insulation layer of PVC-sheathed or rubber-sheathed.

- 10 Outdoor air sensor cable shall be (2 x min 0.3 mm<sup>2</sup>) double insulation layer of PVC-sheathed or rubber-sheathed.
- 11 Tank OLP cable must be (2 x min 0.5 mm<sup>2</sup>), double insulation layer of PVC-sheathed or rubber-sheathed cable.

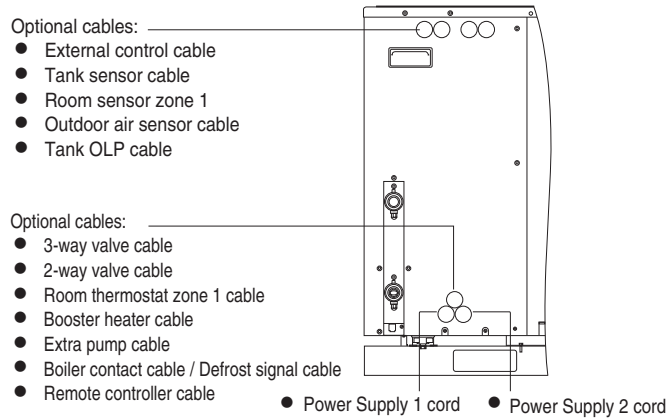

How to guide optional cables and power supply cords to Bushing ⑮

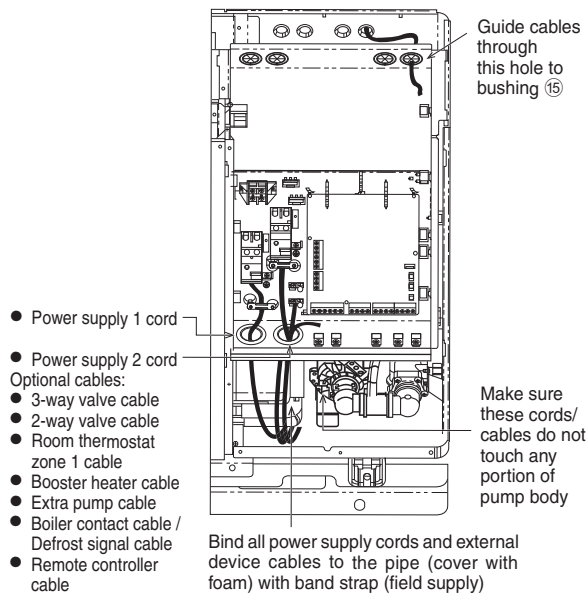

How to guide optional cables and power supply cords to control board

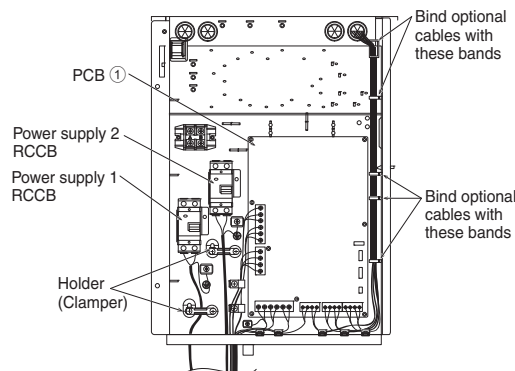

How to guide optional cables and power supply cords (view without internal wiring)

- For connection to optional PCB
  - 1 By connecting optional PCB, 2 Zone temperature control can be achieved. Please connect mixing valves, water pumps and thermistors in zone 1 and zone 2 to each terminals in optional PCB. Temperature of each zone can be controlled independently by remote controller.
  - 2 Pump zone 1 and zone 2 cable shall be (2 x min 1.5 mm<sup>2</sup>), of type designation 60245 IEC 57 or heavier.
  - 3 Solar pump cable shall be (2 x min 1.5 mm<sup>2</sup>), of type designation 60245 IEC 57 or heavier.
  - 4 Pool pump cable shall be (2 x min 1.5 mm<sup>2</sup>), of type designation 60245 IEC 57 or heavier.



- 5 Room thermostat zone 1 and zone 2 cable shall be (4 x min 0.5 mm<sup>2</sup>), of type designation 60245 IEC 57 or heavier.
- 6 Mixing valve zone 1 and zone 2 cable shall be (3 x min 1.5 mm<sup>2</sup>), of type designation 60245 IEC 57 or heavier.
- 7 Room sensor zone 1 and zone 2 cable shall be (2 x min 0.3 mm<sup>2</sup>), double insulation layer (with insulation strength of minimum 30V) of PVC-sheathed or rubber-sheathed cable.
- 8 Buffer tank sensor, pool water sensor and solar sensor cable shall be (2 x min 0.3 mm<sup>2</sup>), double insulation layer (with insulation strength of minimum 30V) of PVC-sheathed or rubber-sheathed cable.
- 9 Water sensor zone 1 and zone 2 cable shall be (2 x min 0.3 mm<sup>2</sup>), double insulation layer of PVC-sheathed or rubber-sheathed cable.
- 10 Demand signal cable shall be (2 x min 0.3 mm<sup>2</sup>), double insulation layer of PVC-sheathed or rubber-sheathed cable.
- 11 SG signal cable shall be (3 x min 0.3 mm<sup>2</sup>), double insulation layer of PVC-sheathed or rubber-sheathed cable.
- 12 Heat/Cool switch cable shall be (2 x min 0.3 mm<sup>2</sup>), double insulation layer of PVC-sheathed or rubber-sheathed cable.
- 13 External compressor switch cable shall be (2 x min 0.3 mm<sup>2</sup>), double insulation layer of PVC-sheathed or rubber-sheathed cable.

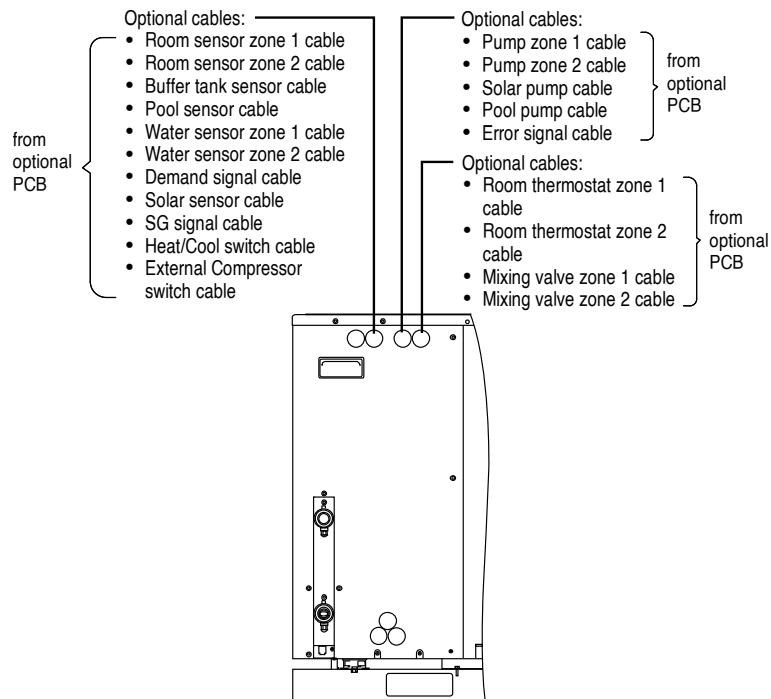

How to guide optional cables to bushing ⑮

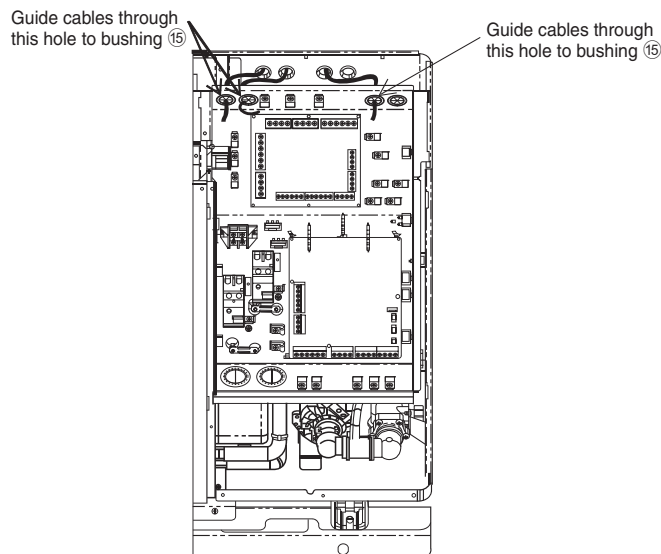

### How to guide optional cables to control board

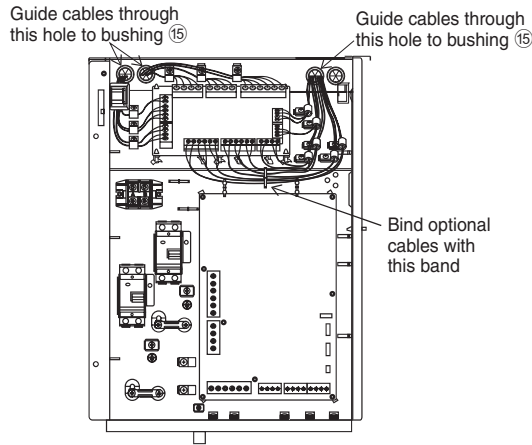

How to guide optional cables (view without internal wiring)

Terminal screw on PCB	Maximum tightening torque cN•m {kgf•cm}
M3	50 {5.1}
M4	120 {12.24}

## 12.1.5 Installation of Remote Controller

### 12.1.5.1 Installation Location

- Install at the height of 1 to 1.5 m from the floor (Location where average room temperature can be detected).
- Install vertically against the wall.
- Avoid the following locations for installation.
  - 1 By the window, etc. exposed to direct sunlight or direct air.
  - 2 In the shadow or backside of objects deviated from the room airflow.
  - 3 Location where condensation occurs (The Remote Controller is not moisture proof or drip proof.)
  - 4 Location near heat source.
  - 5 Uneven surface.
- Keep distance of 1 m or more from the TV, radio and PC. (Cause of fuzzy image or noise)

### 12.1.5.2 Remote Controller Wiring

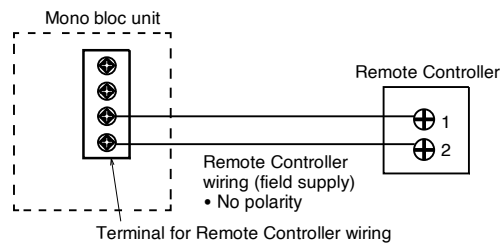

- Remote Controller cable shall be  $(2 \times \text{min } 0.3 \text{ mm}^2)$ , of double insulation PVC-sheathed or rubber sheathed cable. Total cable length shall be 50 m or less.
- Be careful not to connect cables to other terminals (e.g. power source wiring terminal). Malfunction may occur.
- Do not bundle together with the power source wiring or store in the same metal tube. Operation error may occur.

### 12.1.5.3 Mounting The Remote Controller

For exposed type

**Preparation:** Make 2 holes for screws using a driver.

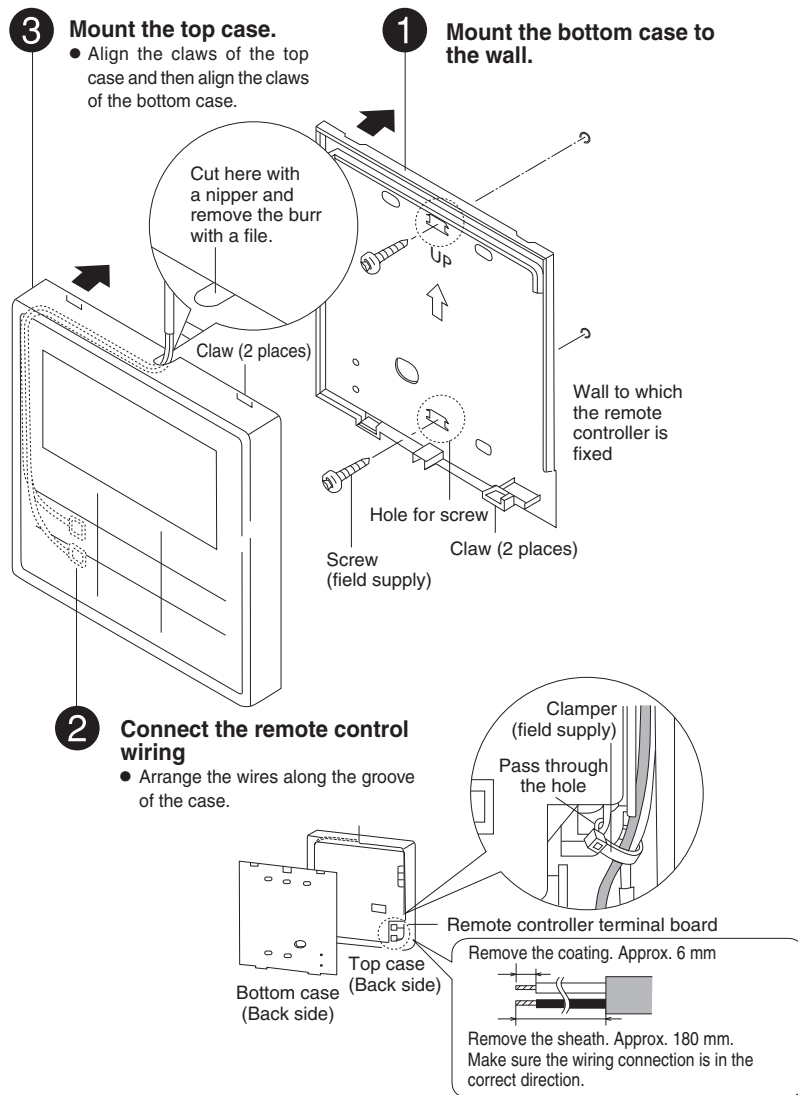

For embedded type

**Preparation:** Make 2 holes for screws using a driver.

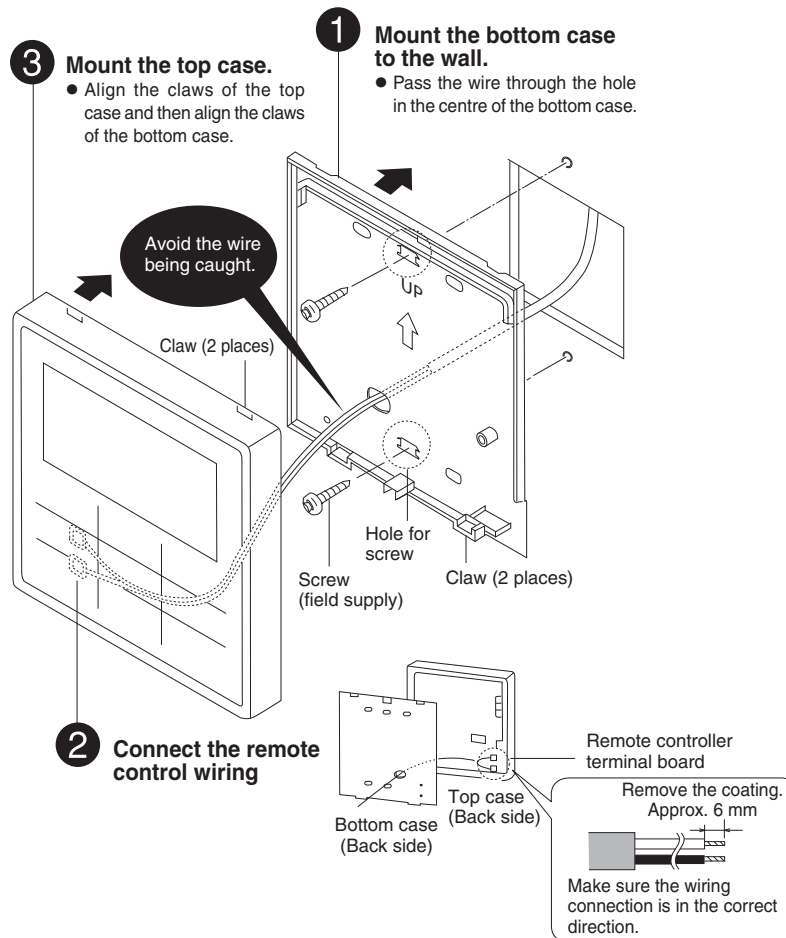

**⚠ WARNING**

This section is for authorized and licensed electrician only. Work behind the Cabinet Front Plate ⑩ secured by screws must only be carried out under supervision of qualified contractor, installation engineer or service person.

## 12.1.6 Installation of Network Adaptor and Base Pan Heater

### 12.1.6.1 Network Adaptor and Installation (Optional)

1. **Open the Cabinet Front Plate and Cabinet Top Plate, then connect the Network Adaptor Cable to the CN-CNT connector on the printed circuit board.**
  - Pull the cable out of the Mono bloc unit so that there is no pinching.
  - If an optional PCB has been install in the Mono bloc unit, connect the CN-CNT connector to Optional PCB.
3. **On the wall near the Mono bloc unit, attach the adaptor by screwing screws through the holes in the back cover.**

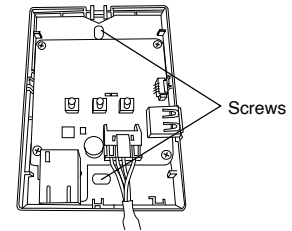
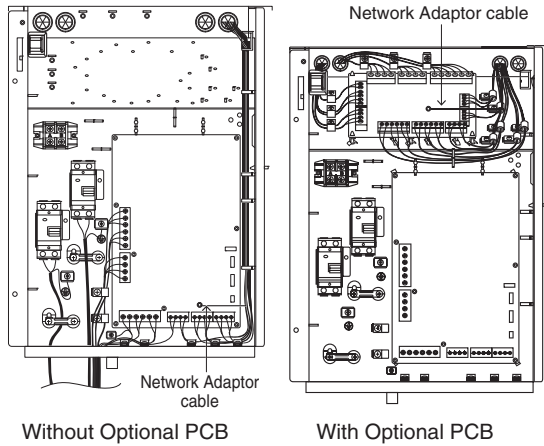

4. **Pull the CN-CNT cable through the hole in the bottom of the adaptor and re-attach the front cover to the back cover.**

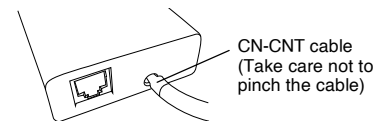

5. **Use the included cord clamp to fix the CN-CNT cable to the wall.**

Pull the cable around as shown in the diagram so that external forces cannot act on the connector in the adaptor.

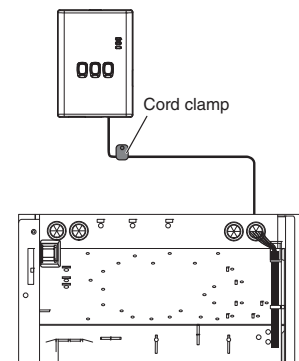

2. **Insert a flat head screwdriver into the slot on the top of the adaptor and remove the cover. Connect the other end of the CN-CNT cable connector to the connector inside the adaptor.**

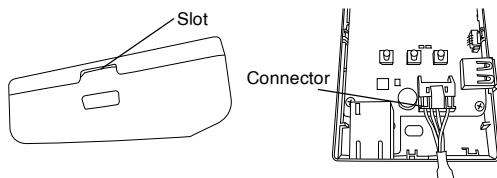

### 12.1.6.2 Base Pan Heater (Optional)

- It is strongly recommended to install a Base Pan Heater (optional) if the Mono bloc unit is installed in cold climate area. Refer the Base Pan Heater (optional) installation instruction for details of installation.

### 12.1.7 Charging the Water

- Make sure all the piping installations are properly done before carry out below steps.
  - Take out the Cover by removing the 2 mounting screws to access to the Pressure Relief Valve and Air Purge Valve.

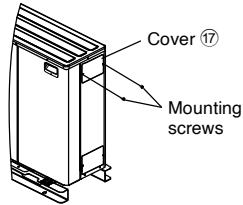

- Turn the plug on the Air Purge Valve outlet anticlockwise by one complete turn from fully closed position.

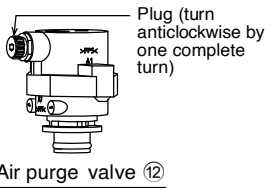

- Set the Pressure Relief Valve level "DOWN".

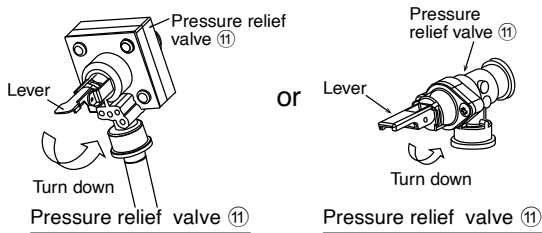

- Start filling water (with pressure more than 0.1 MPa (1 bar)) to the Mono bloc unit via water inlet. Stop filling water if the free water flow through Pressure Relief Valve drain hose.
- Turn ON the power supply and make sure Water Pump is running.
- Check and make sure no water leaking at the tube connecting points.
- Reinstall the Cover by tightening the 2 mounting screws.

### 12.1.8 Reconfirmation

<b>WARNING</b>
Be sure to switch off all power supply before performing each of the below checkings. Before obtaining access to terminals, all supply circuits must be disconnected.

#### 12.1.8.1 Check Water Pressure \*(0.1 MPa = 1 bar)

Water pressure should not lower than 0.05 MPa (with inspects the Water Pressure Gauge). If necessary add tap water into the water circuit.

#### 12.1.8.2 Check Pressure Relief Valve

- Check for correct operation of Pressure Relief Valve by turning on the lever to become horizontal.
- If you do not hear a clacking sound (due to water drainage), contact your local authorized dealer.
- Push down the lever after finish checking.
- In case the water keeps drained out from the unit, switch off the system, and then contact your local authorized dealer.

#### 12.1.8.3 Expansion Vessel Pre Pressure Checking

[Upper limit water volume of the system]

The Mono bloc unit has a build-in Expansion Vessel with 6 L air capacity and initial pressure of 1 bar.

- Without antifreeze agent condition  
Total amount of water in the system should be below 150 L.

If the total amount of water is more than 150 L, please add expansion vessel (field supply).

- With antifreeze agent condition  
In the case of using antifreeze agent, expansion rate  $\epsilon$  is different depending on its maker.

Please refer to the antifreeze agent maker for the expansion rate  $\epsilon$  before calculate the upper limit water volume of the system.

The expansion vessel capacity required for the system can be calculated from the formula below.

$$V = \frac{\epsilon \times V_0}{1 - \frac{98 + P_1}{98 + P_2}}$$

V : Required gas volume <expansion vessel volume L>

$V_0$  : System total water volume <L>

$\epsilon$  : Expansion rate 5 → 60°C

$P_1$  : Expansion tank filling pressure

$P_2$  : System maximum pressure

- ( ) Please confirm at actual place

- The gas volume of the sealed type expansion vessel is presented by <V>.

○ It's advised to add 10% margin for required gas volume of calculation.

= (depends on antifreeze agent used)  
= (100) kPa  
= 300 kPa

[Adjustment of the initial pressure of the expansion vessel when there is a difference in installation height]  
If the height difference between the Mono bloc unit and the highest point of the system water circuit (H) is more than 7m, please adjust the initial pressure of the expansion vessel ( $P_g$ ) according to the following formula.

$$P_g = (H \times 10 + 30) \text{ kPa}$$

#### 12.1.8.4 Check RCCB

Ensure the RCCB set to "ON" condition before check RCCB 2.

Turn on the power supply to the Mono bloc unit.

This testing could only be done when power is supplied to the Mono bloc unit.

 <b>WARNING</b>
--

Be careful not to touch parts other than RCCB test button when the power is supplied to Mono bloc unit. Else, electrical shock may happen.
--

- Push the "TEST" button on the RCCB. The lever would turn down and indicate "0", if it functions normal.
- Contact authorized dealer if the RCCB malfunction.
- Turn off the power supply to the Mono bloc unit.
- If RCCB functions normal, set the lever to "ON" again after testing finish.

This product contains fluorinated greenhouse gasses.

Refrigerant type : R32 (GWP=675)

Amount : 1.30 kg (0.878 ton CO<sub>2</sub> equivalent)

#### 12.1.9 Test Run

1. Before test run, make sure below items have been checked:-
  - Pipework are properly done.
  - Electric cable connecting work are properly done.
  - Mono bloc unit is filled up with water and trapped air is released.
2. Antifreeze agent must be added into water circuit to prevent freezing of water when outdoor ambient temperatures is low. Recommended antifreeze: Propylene glycol: 40% (equivalent to -20°C)
3. Set ON to the Mono bloc unit and RCCB. Then, for remote control operation please refers to (Mono bloc) Air-to-Water Heatpump's operation instruction.
4. For normal operation, pressure gauge reading should be in between 0.05 MPa and 0.3 MPa.
5. After test run, please clean the Water filter. Reinstall it after finish cleaning.

#### 12.1.9.1 Check Water Flow of Water Circuit

Confirm the maximum water flow during main pump operation not less than 15 l/min.

\*Water flow can be check through service setup (Pump Max Speed)

[Heating operation at low water temperature with lower water flow may trigger "H75" during defrost process.]

#### 12.1.9.2 Reset Overload Protector

Overload Protector serves the safety purpose to prevent the water over heating. When the Overload Protector trip at high water temperature, take below steps to reset it.

1. Take out the cover.
2. Use a test pen to push the centre button gently in order to reset the Overload Protector.
3. Fix the cover to the original fixing condition.

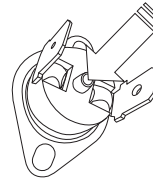

Use test pen to push this button for reset Overload Protector ⑩.

#### 12.1.10 Maintenance

- In order to ensure optimal performance of the unit, seasonal inspections on the unit, functional check of RCCB, field wiring and piping have to be carried out at regular intervals. This maintenance should be carried out by authorized dealer.

##### 12.1.10.1 Maintenance for Water Filter Set

1. Remove the Cover by loosening the mounting screws to access to the Water Filter Set.
2. Turn OFF power supply.
3. Set the two valves for the Water Filter Set to "CLOSE".
4. Take off the clip, then gently pull out the mesh. Beware of small amount water drain out from it.
5. Clean the mesh with warm water to remove all the stain. Use soft brush if necessary.
6. Reinstall the mesh to the Water Filter Set and set back the clip on it.
7. Set the two valves for the Water Filter Set to "OPEN".
8. Turn ON power supply.
9. After cleaning, reinstall the Cover by tightening the mounting screws properly.

 <b>WARNING</b>
--

Do not add or replace other than R32 type. It may cause product damage, burst, injury and etc. Use compatible R32 tools for refrigerant piping work and refrigerant charging during installation or servicing.
--

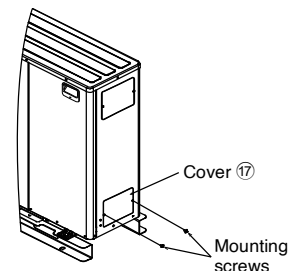

## 12.2 Variation of system

This section introduces variation of various systems using Air-To-Water Heatpump and actual setting method.

### 12.2.1 Introduce application related to temperature setting.

#### 12.2.1.1 Temperature setting variation for heating

##### 1. Remote Controller

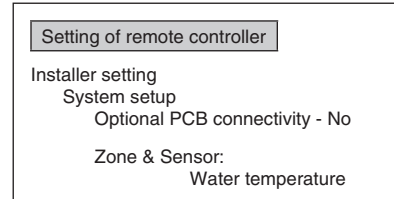
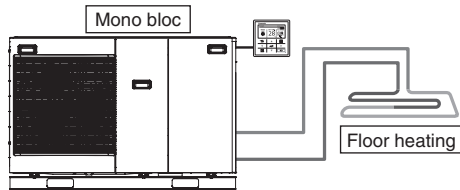

Connect floor heating or radiator directly to the Mono bloc.  
This is the basic form of the most simple system.

##### 2. Room Thermostat

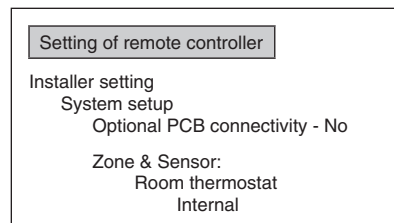
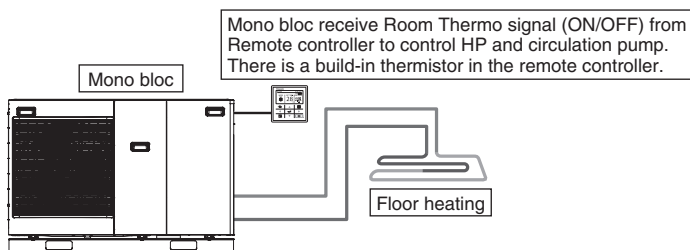

Connect floor heating or radiator directly to the Mono bloc.  
Install the remote controller in the room where floor heating is installed.  
This is an application that uses remote controller as Room Thermostat.

##### 3. External Room Thermostat

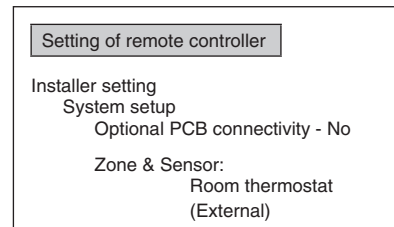
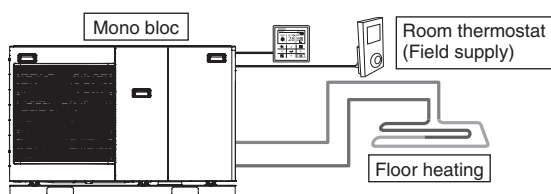

Connect floor heating or radiator directly to Mono bloc.  
Install separate external Room Thermostat (field supply) in the room where floor heating is installed.  
This is an application that uses external Room Thermostat.



#### 4. Room Thermistor

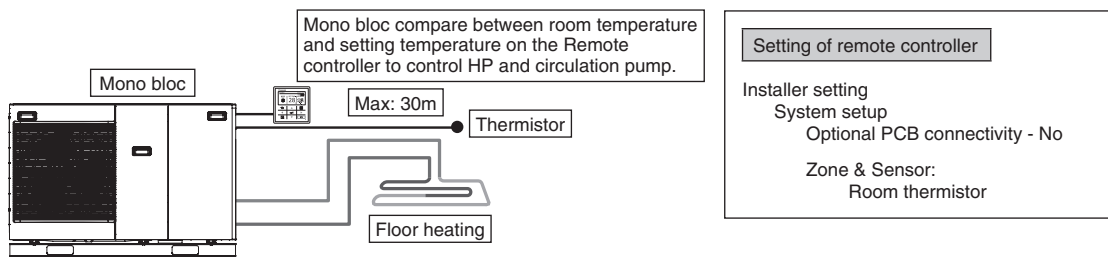

Connect floor heating or radiator directly to Mono bloc.  
Install separate external room thermistor (specified by Panasonic) in the room where floor heating is installed.  
This is an application that uses external room thermistor.

There are 2 kinds of circulation water temperature setting method.  
Direct: set direct circulation water temperature (fixed value)  
Compensation curve: set circulation water temperature depends on outdoor ambient temperature  
In case of Room thermo or Room thermistor, compensation curve can be set.  
In this case, compensation curve is shifted according to the thermo ON/OFF situation.

- (Example) If room temperature increasing speed is;  
very slow → shift up the compensation curve  
very fast → shift down the compensation curve

## 12.2.1.2 Examples of installations

### Floor heating 1 + Floor heating 2

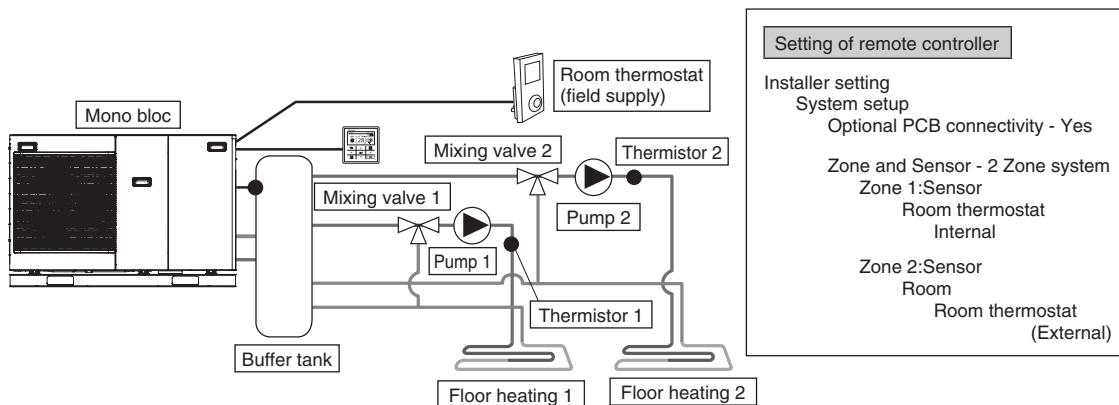

Connect floor heating to 2 circuits through buffer tank as shown in the figure.  
 Install mixing valves, pumps and thermistors (specified by Panasonic) on both circuits.  
 Install the remote controller in one of the circuit and use it as Room Thermostat.  
 Install external Room Thermostat (field supply) in another circuit.  
 Both circuits can set circulation water temperature independently.  
 Install buffer tank thermistor on buffer tank.  
 It requires connection setting of buffer tank and  $\Delta T$  temperature setting at heating operation separately.  
 This system requires optional PCB (CZ-NS4P).

### Floor heating + Radiator

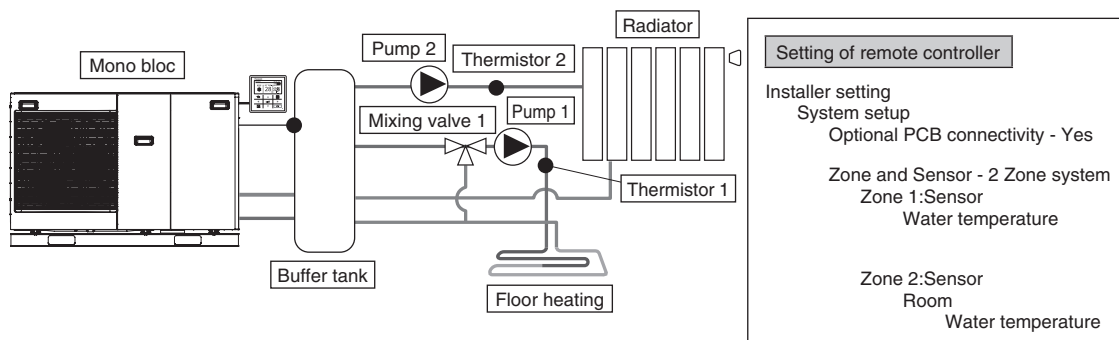

Connect floor heating or radiator to 2 circuits through buffer tank as shown in figure.  
 Install pumps and thermistors (specified by Panasonic) on both circuits.  
 Install mixing valve in the circuit with lower temperature among the 2 circuits.  
 (Generally, if install floor heating and radiator circuit at 2 zones, install mixing valve in floor heating circuit.)  
 For temperature setting, select circulation water temperature for both circuits.  
 Both circuits can set circulation water temperature independently.  
 Install buffer tank thermistor on buffer tank.  
 It requires connection setting of buffer tank and  $\Delta T$  temperature setting at heating operation separately.  
 This system requires the optional PCB (CZ-NS4P).  
 Mind that if there is no mixing valve at the secondary side, the circulation water temperature may get higher than setting temperature.

## Floor heating + Swimming pool

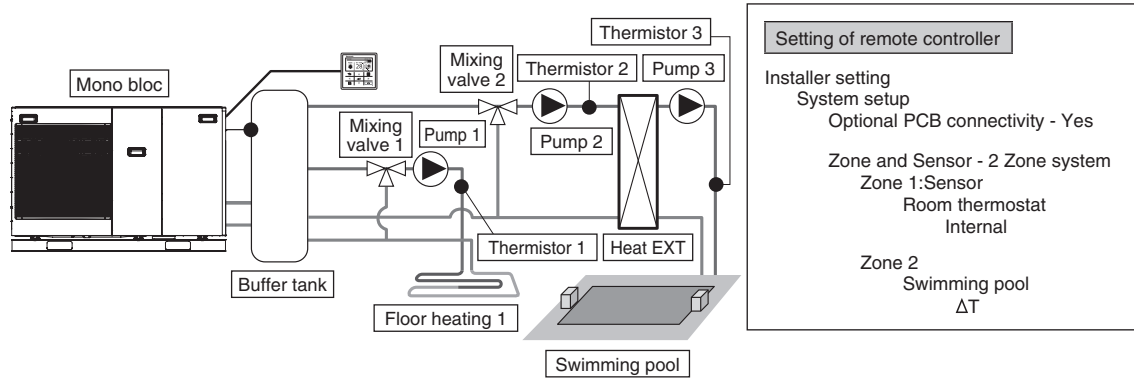

Connect floor heating and swimming pool to 2 circuits through buffer tank as shown in figure.

Install mixing valves, pumps and thermistors (specified by Panasonic) on both circuits.

Then, install additional pool heat exchanger, pool pump and pool sensor on pool circuit.

Install the remote controller in room where floor heating is installed. Circulation water temperature of floor heating and swimming pool can be set independently.

Install buffer tank sensor on buffer tank.

It requires connection setting of buffer tank and  $\Delta T$  temperature setting at heating operation separately. This system requires the optional PCB (CZ-NS4P).

\* Must connect swimming pool to "Zone 2".

If it is connected to swimming pool, operation of pool will stop when "Cooling" is operated.

## Swimming pool only

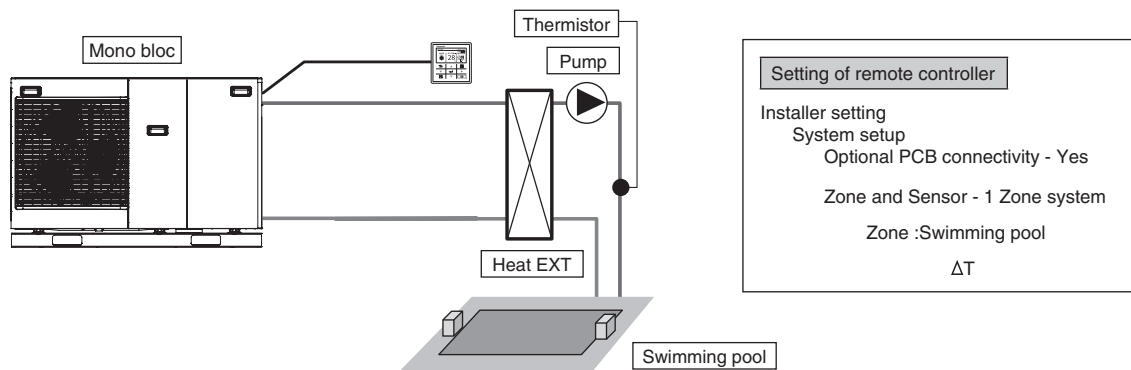

This is an application that connects to the swimming pool only.

Connects pool heat exchanger directly to Mono bloc without using buffer tank.

Install pool pump and pool sensor (specified by Panasonic) at secondary side of the pool heat exchanger.

Install the remote controller in room where floor heating is installed.

Temperature of swimming pool can be set independently.

This system requires the optional PCB (CZ-NS4P).

In this application, cooling mode cannot be selected. (not display on remote controller)

## Simple 2 zone (Floor heating + Radiator)

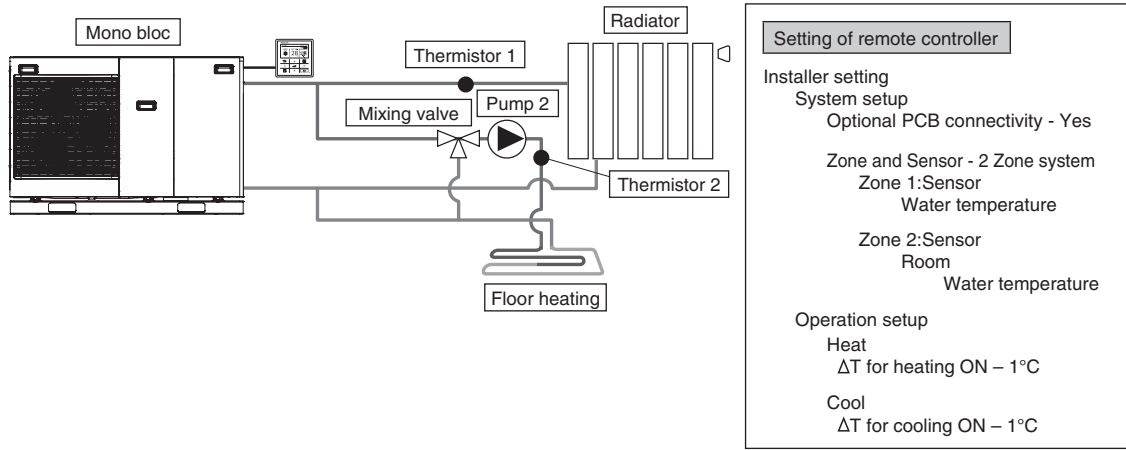

This is an example of simple 2 zone control without using buffer tank.

Built-in pump from Mono bloc served as a pump in zone 1.

Install mixing valve, pump and thermistor (specified by Panasonic) on zone 2 circuit.

Please be sure to assign high temperature side to zone 1 as temperature of zone 1 cannot be adjusted.

Zone 1 thermistor is required to display temperature of zone 1 on remote controller.

Circulation water temperature of both circuits can be set independently.

(However, temperature of high temperature side and low temperature side cannot be reversed)

This system requires the optional PCB (CZ-NS4P).

(NOTE)

- Thermistor 1 does not affect operation directly. But error happens if it is not installed.  
Please adjust flow rate of zone 1 and zone 2 to be in balance. If it is not adjusted correctly, it may affect the performance.  
(If zone 2 pump flow rate is too high, there is possibility that no hot water flowing to zone 1.)  
Flow rate can be confirmed by "Actuator Check" from maintenance menu.

**12.2.2 Introduce applications of system that uses optional equipment.**  
**DHW (Domestic Hot Water) Tank connection**

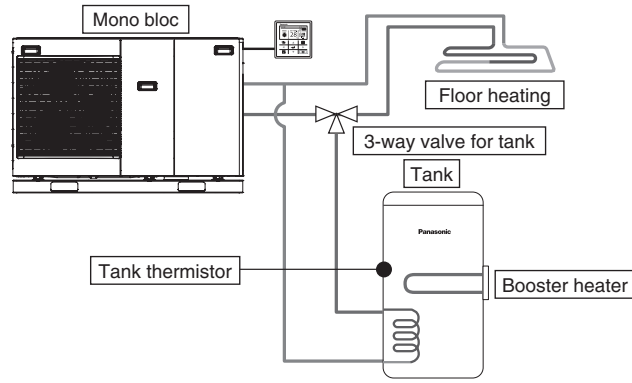

This is an application that connects the DHW tank to the Mono bloc through 3-way valve. DHW tank's temperature is detected by tank thermistor (specified by Panasonic).

**Tank + Solar connection**

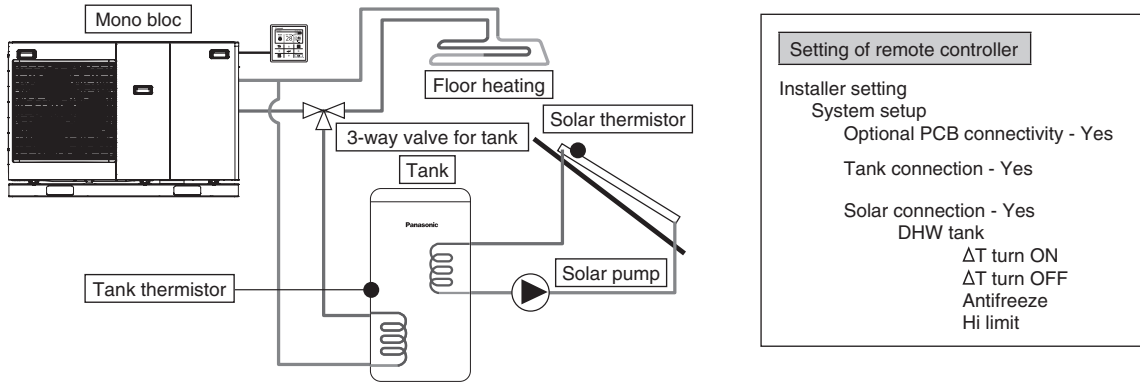

This is an application that connects the DHW tank to the Mono bloc through 3-way valve before connect the solar water heater to heat up the tank. DHW tank's temperature is detected by tank thermistor (specified by Panasonic). Solar panel's temperature is detected by solar thermistor (specified by Panasonic). DHW tank shall use tank with built-in solar heat exchange coil independently. Heat accumulation operates automatically by comparing the temperature of tank thermistor and solar thermistor. During winter season, solar pump for circuit protection will be activated continuously. If does not want to activate the solar pump operation, please use glycol and set the anti-freezing operation start temperature to -20°C. This system requires optional PCB (CZ-NS4P).

**Buffer tank connection**

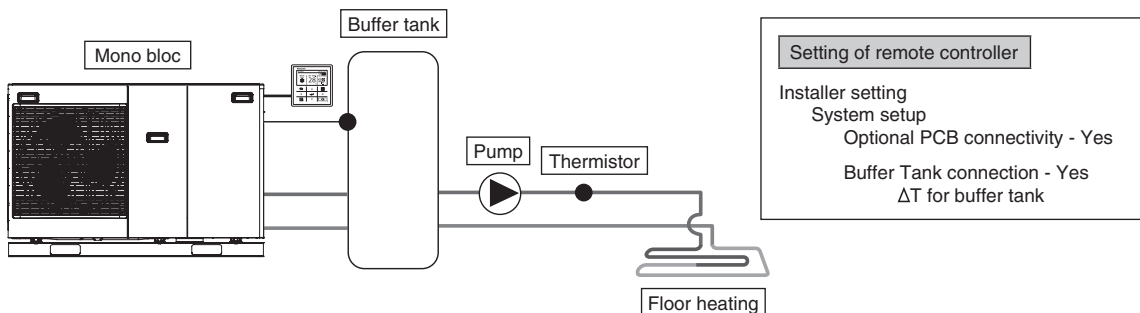

This is an application that connects the buffer tank to the Mono bloc. Buffer tank's temperature is detected by buffer tank thermistor (specified by Panasonic). This system requires optional PCB (CZ-NS4P).

## Buffer tank + Solar

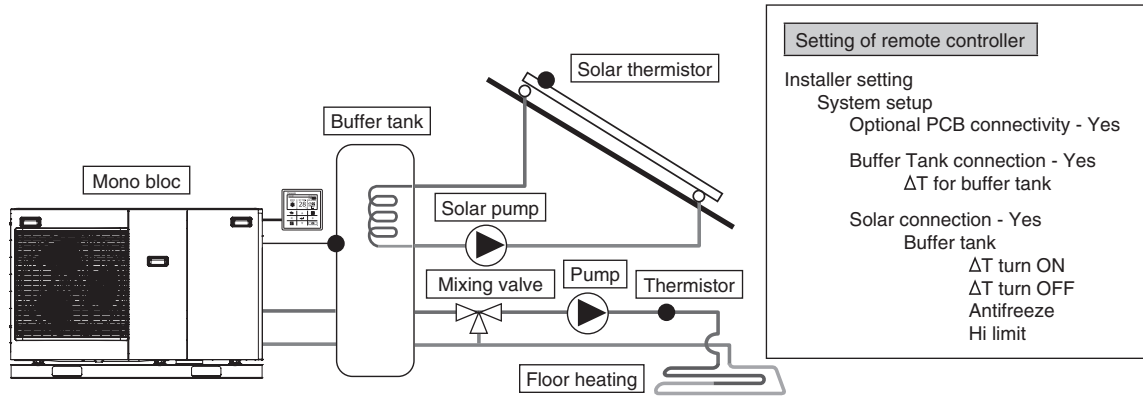

This is an application that connects the buffer tank to the Mono bloc before connecting to the solar water heater to heat up the tank.

Buffer tank's temperature is detected by buffer tank thermistor (specified by Panasonic).

Solar panel's temperature is detected by solar thermistor (specified by Panasonic).

Buffer tank shall use tank with built-in solar heat exchange coil independently.

During winter season, solar pump for circuit protection will be activated continuously. If does not want to activate the solar pump operation, please use glycol and set the anti-freezing operation start temperature to  $-20^{\circ}\text{C}$ .

Heat accumulation operates automatically by comparing the temperature of tank thermistor and solar thermistor.

This system requires optional PCB (CZ-NS4P).

## Boiler connection

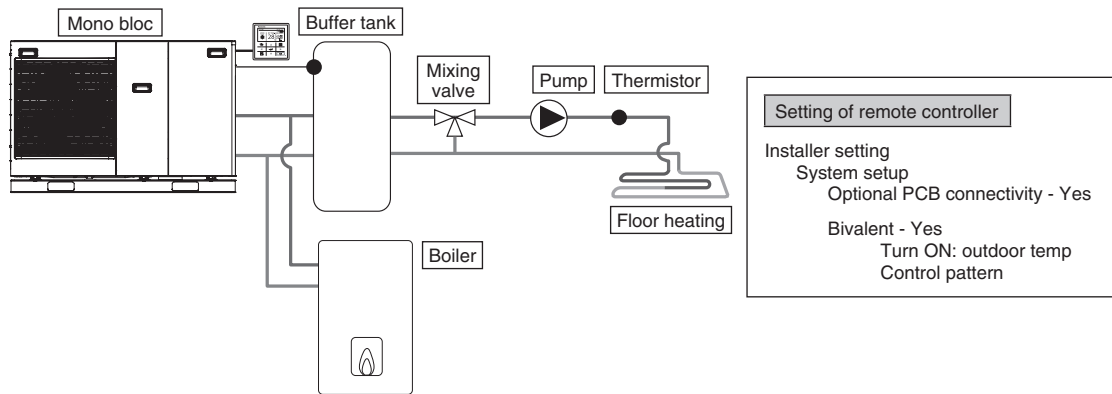

This is an application that connects the boiler to the Mono bloc, to compensate for insufficient capacity by operate boiler when outdoor temperature drops & heat pump capacity is insufficient.

Boiler is connected parallel with heat pump against heating circuit.

There are 3 modes selectable by remote controller for boiler connection.

Besides that, an application that connects to the DHW tank's circuit to heat up tank's hot water is also possible. (Operation setting of boiler shall be responsible by installer.)

This system requires optional PCB (CZ-NS4P).

Depending on the settings of the boiler, it is recommended to install buffer tank as temperature of circulating water may get higher. (It must connect to buffer tank especially when selecting Advanced Parallel setting.)

### WARNING

Panasonic is NOT responsible for incorrect or unsafe situation of the boiler system.

### CAUTION

Make sure the boiler and its integration in the system complies with applicable legislation.  
 Make sure the return water temperature from the heating circuit to the indoor unit does NOT exceed  $55^{\circ}\text{C}$ .  
 Boiler is turned off by safety control when the water temperature of the heating circuit exceed  $85^{\circ}\text{C}$ .

## 12.3 How to Fix External Device

### 12.3.1 Connecting Cables Length

When connecting cables between Mono bloc and external devices, the length of the said cables must not exceed the maximum length as shown in the table.

External device	Maximum cables length (m)
Two-way valve	50
Three-way valve	50
Mixing valve	50
Room thermostat	50
Booster heater	50
Extra pump	50
Solar pump	50
Pool pump	50
Pump	50
Boiler contact / Defrost signal	50
External control	50
Tank sensor	30
Room sensor	30
Outdoor air sensor	30
Tank OLP	30
Buffer tank sensor	30
Pool water sensor	30
Solar sensor	30
Water sensor	30
Demand signal	50
SG signal	50
Heat/Cool switch	50
External compressor switch	50

#### 12.3.1.1 Connection of the main PCB

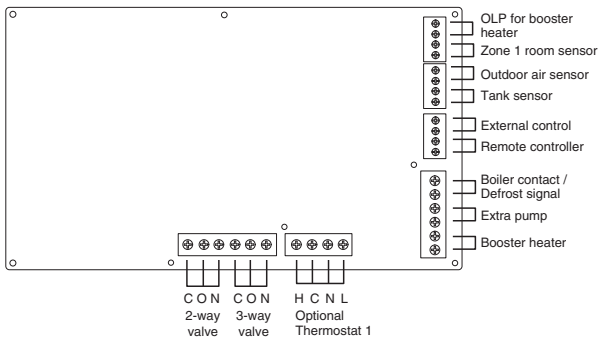

#### ■ Signal inputs

Optional Thermostat	L N =AC230V, Heat, Cool=Thermostat heat, Cool terminal *It does not function when using the optional PCB
OLP for booster heater	Dry contact Vcc-Bit1, Vcc-Bit2 open/short (System setup necessary) It is connected to the safety device (OLP) of DHW tank.
External control	Dry contact Open=not operate, Short=operate (System setup necessary) Able to turn ON/OFF the operation by external switch
Remote controller	Connected (Please use 2 cores wire for relocation and extension. Total cable length shall be 50m or less.)

#### ■ Outputs

3-way valve	AC230V N=Neutral Open, Close=direction (For circuit switching when connected to DHW tank)
2-way valve	AC230V N=Neutral Open, Close (Prevent water circuit pass through during cooling mode)
Extra pump	AC230V (Used when Mono bloc pump capacity is insufficient)
Booster heater	AC230V (Used when using booster heater in DHW tank)
Boiler contact/ Defrost signal	Dry contact (System setup necessary)

#### ■ Thermistor inputs

Zone 1 room sensor	PAW-A2W-TSRT *It does not work when using the optional PCB
Outdoor air sensor	AW-A2W-TSOD (Total cable length shall be 30m or less)
Tank sensor	Please use Panasonic specified part

#### 12.3.1.2 Connection of Optional PCB (CZ-NS4P)

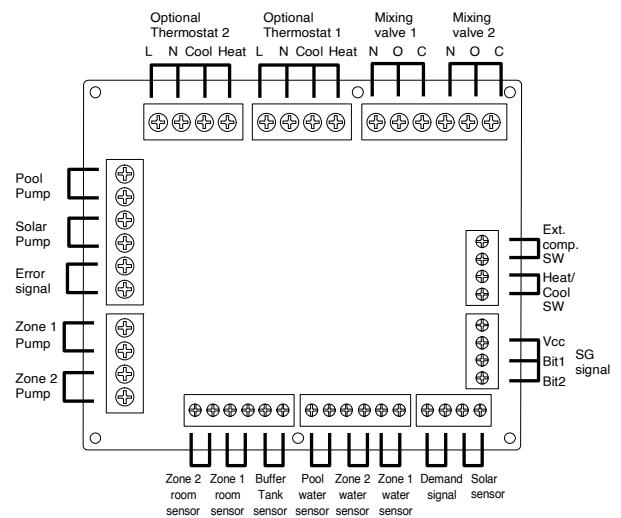

#### ■ Signal inputs

Optional Thermostat	L N =AC230V, Heat, Cool=Thermostat heat, Cool terminal
SG signal	Dry contact Vcc-Bit1, Vcc-Bit2 open/short (System setup necessary) Switching SW (Please connect to the 2 contacts controller)
Heat/Cool SW	Dry contact Open=Heat, Short=Cool (System setup necessary)
External comp.SW	Dry contact Open=Comp.ON, Short=Comp.OFF (System setup necessary)
Demand signal	DC 0~10V (System setup necessary) Please connect to the DC 0~10V controller.

#### ■ Outputs

Mixing valve	AC230V N=Neutral Open, Close=mixture direction Operating time: 30s~120s
Pool pump	AC230V
Solar pump	AC230V
Zone pump	AC230V

■ Thermistor inputs

Zone room sensor	PAW-A2W-TSRT
Buffer tank sensor	PAW-A2W-TSBU
Pool water sensor	PAW-A2W-TSHC
Zone water sensor	PAW-A2W-TSHC
Solar sensor	PAW-A2W-TSSO

### 12.3.1.3 Recommended External Device Specification

- This section explains about the external devices (optional) recommended by Panasonic. Please always ensure to use the correct external device during system installation.

- For optional sensor.

- 1 Buffer tank sensor: PAW-A2W-TSBU  
Use for measurement of the buffer tank temperature.  
Insert the sensor into the sensor pocket and paste it on the buffer tank surface.

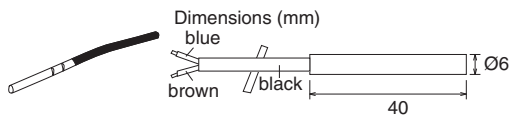

- 2 Zone water sensor: PAW-A2W-TSHC  
Use to detect the water temperature of the control zone.  
Mount it on the water piping by using the stainless steel metal strap and contact paste (both are included).

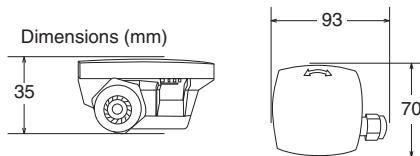

- 3 Outdoor sensor: PAW-A2W-TSOD  
If the installation location of the outdoor unit is exposed to direct sunlight, the outdoor air temperature sensor will be unable to measure the actual outdoor ambient temperature correctly.  
In this case, optional outdoor temperature sensor can be fixed at a suitable location to more accurately measure ambient temperature.

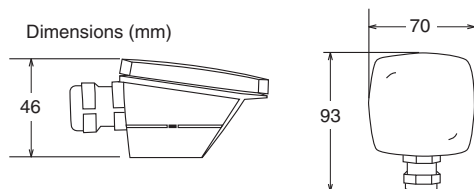

- 4 Room sensor: PAW-A2W-TSRT  
Install the room temperature sensor to the room which requires room temperature control.

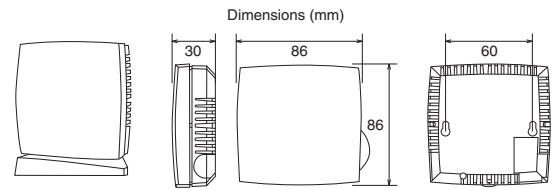

- 5 Solar sensor: PAW-A2W-TSSO  
Use for measurement of the solar panel temperature.  
Insert the sensor into the sensor pocket and paste it on the solar panel surface.

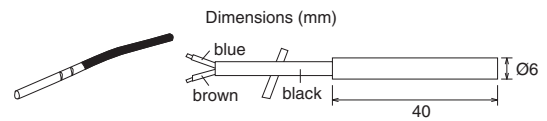

- 6 Please refer to the table below for sensor characteristic of the sensors mentioned above.

Temperature (°C)	Resistance (kΩ)
150	0.147
140	0.186
130	0.236
120	0.302
110	0.390
100	0.511
90	0.686
80	0.932
70	1.279
65	1.504
60	1.777
55	2.106
50	2.508
45	3.003
40	3.615
35	4.375
30	5.326
25	6.523
20	8.044
15	9.980
10	12.443
5	15.604
0	19.70
-5	25.05
-10	32.10
-15	41.45
-20	53.92
-25	70.53
-30	93.05
-35	124.24
-40	167.82



- For optional pump.  
Power supply: AC230V/50Hz, <500W  
Recommended part: Yonos 25/6: made by Wilo

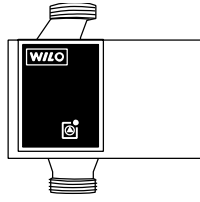

- For optional mixing valve.  
Power supply: AC230V/50Hz (input open/output close)  
Operating time: 30s~120s  
Recommended part: 167032: made by Caleffi

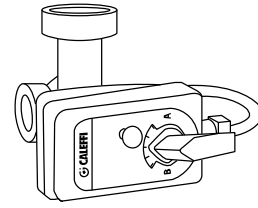

# 12.4 System Installation

## 12.4.1 Remote Controller Outline

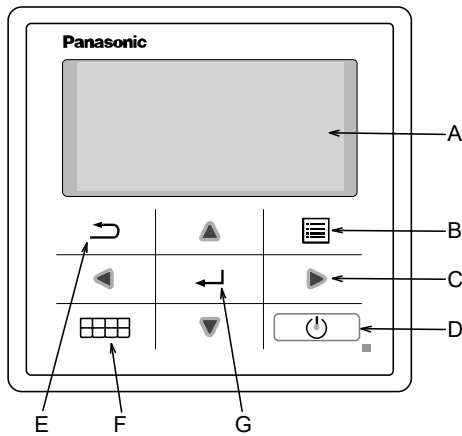

Name	Function
A: Main screen	Display information
B: Menu	Open/Close main menu
C: Triangle (Move)	Select or change item
D: Operate	Start/Stop operation
E: Back	Back to previous item
F: Quick Menu	Open/Close Quick menu
G: OK	Confirm

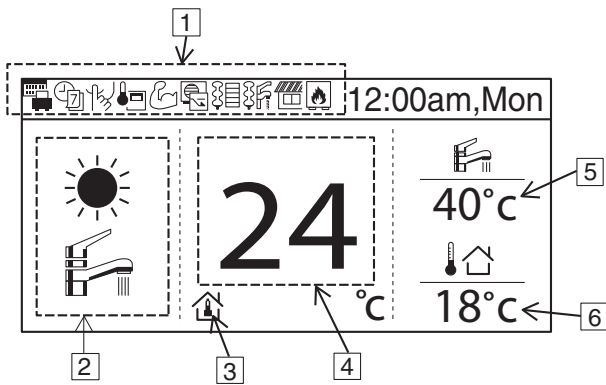

Name	Function
1: Function icon	Display set function/status
	Holiday mode
	Weekly timer
	Quiet mode
	Remote controller room thermostat
	Powerful mode
	Demand control
	Room heater
	Tank heater
	Solar
	Boiler

- 2: Mode
- Display set mode/current status of mode
- Heating
  - Cooling
  - Auto
  - Hot water supply
  - Auto heating
  - Auto cooling
  - Heat pump operating
- 3: Temp setting
- Set room temp
  - Compensation curve
  - Set direct water temp
  - Set pool temp
- 4: Display Heat temp    Display current heating temperature (it is set temperature when enclosed by line)
- 5: Display tank temp    Display current tank temperature (it is set temperature when enclosed by line)
- 6: Outdoor temp    Display outdoor temp

## First time of power ON (Start of installation)

Initialization	12:00am,Mon
Initializing.	

When power is ON, firstly initialization screen appears (10 sec)

12:00am,Mon	
[⏻] Start	

When initialization screen ends, it turns to normal screen.

Language	12:00am,Mon
ENGLISH	
FRANÇAIS	
DEUTSCH	
ITALIANO	
▼ Select	[↵] Confirm

When any button is pressed, language setting screen appears. (NOTE) If initial setting is not performed, it does not go into menu.

Clock format	12:00am,Mon
24h	
▼	
am/pm	
▼ Select	[↵] Confirm

When language is set, setting screen of time display appears (24h/am/pm)

Date & time	12:00am,Mon
Year/Month/Day	Hour : Min
2015 / 01 / 01	12 : 00
↕ Select	[↵] Confirm

YY/MM/DD/Time setup screen appears

12:00am,Mon	
[⏻] Start	

Back to initial screen

Main Menu	12:00am,Mon
System check	
Personal setup	
Service contact	
Installer setup	
▲ Select	[↵] Confirm

Confirm to go into Installer setup

## 12.4.2 Installer Setup

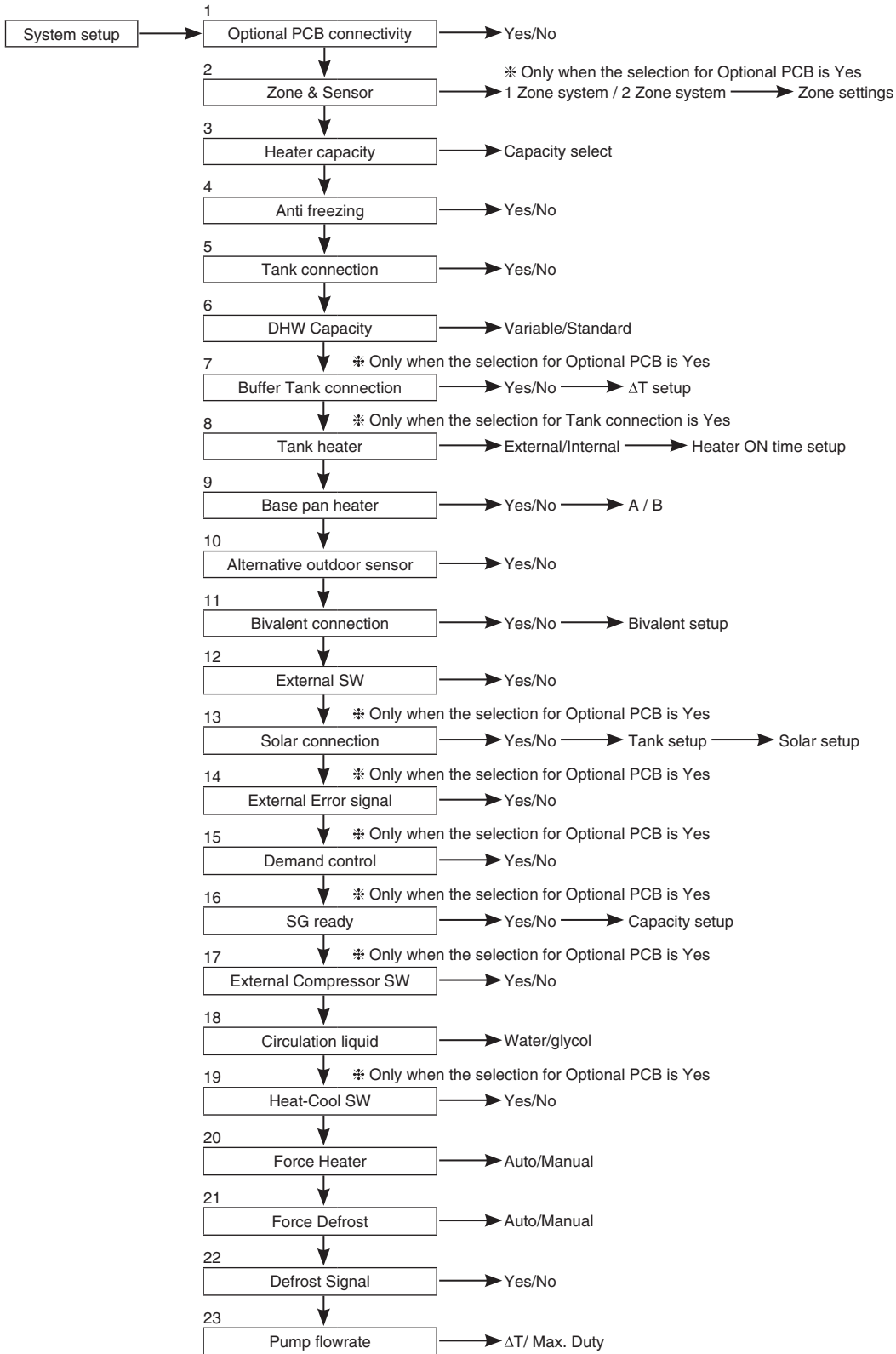

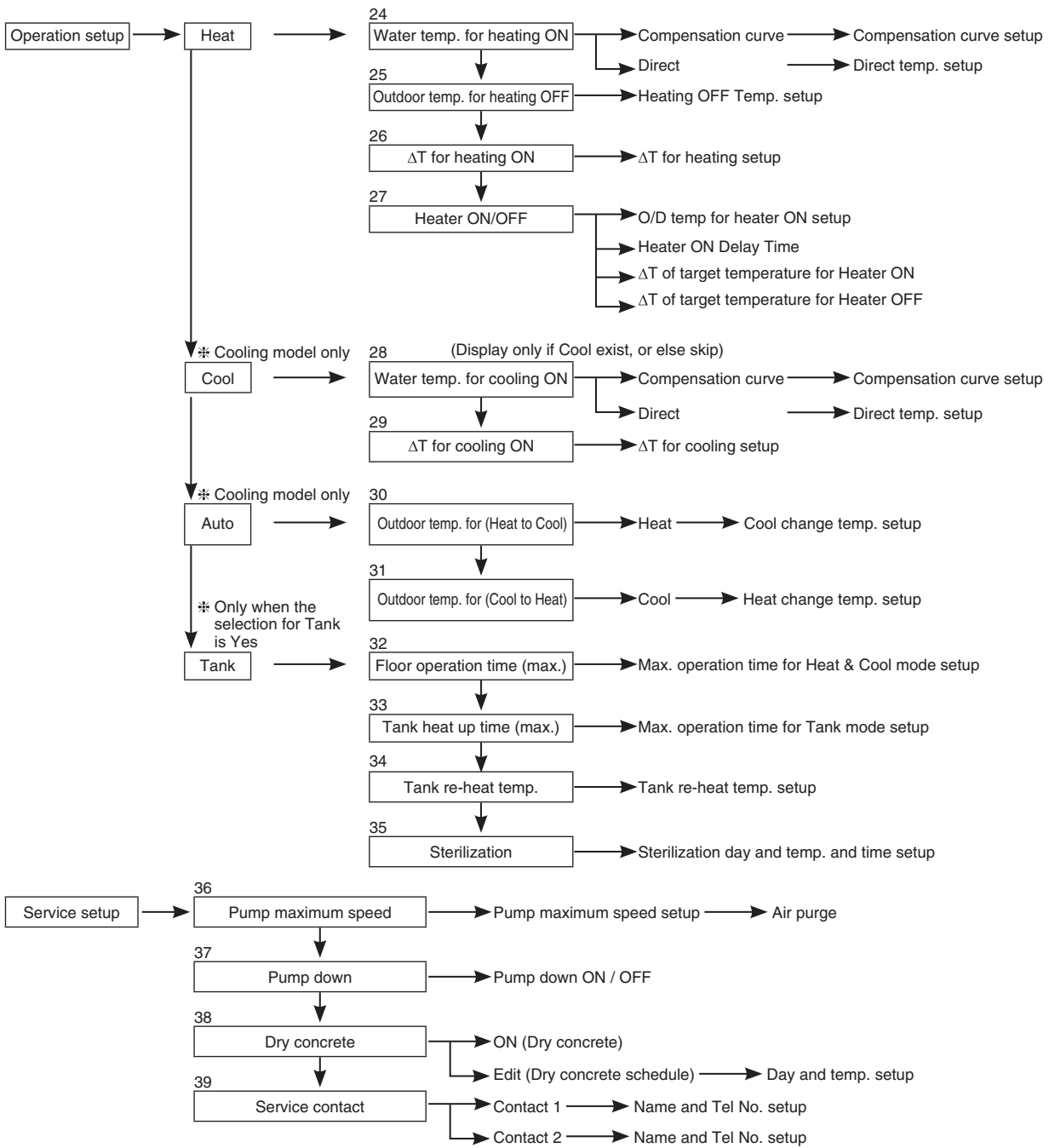

## 12.4.3 System Setup

<div style="border: 1px solid black; padding: 2px; display: inline-block; margin-bottom: 5px;"><b>1. Optional PCB connectivity</b></div> <div style="border: 1px solid black; padding: 2px; display: inline-block; margin-left: 20px;">Initial setting: No</div> <p>If function below is necessary, please purchase and install optional PCB. Please select Yes after installing optional PCB.</p> <ul style="list-style-type: none"> <li>• 2-zone control</li> <li>• Pool</li> <li>• Buffer tank</li> <li>• Solar</li> <li>• External error signal output</li> <li>• Demand control</li> <li>• SG ready</li> <li>• Stop heat source unit by external SW</li> </ul>	<table border="1" style="width: 100%; border-collapse: collapse;"> <tr><td style="text-align: right;">System setup</td><td style="text-align: right;">12:00am, Mon</td></tr> <tr><td colspan="2" style="background-color: #f0f0f0;">Optional PCB connectivity</td></tr> <tr><td colspan="2">Zone &amp; Sensor</td></tr> <tr><td colspan="2">Heater capacity</td></tr> <tr><td colspan="2">Anti freezing</td></tr> <tr><td style="text-align: right;">▼ Select</td><td style="text-align: right;">[↵] Confirm</td></tr> </table>	System setup	12:00am, Mon	Optional PCB connectivity		Zone & Sensor		Heater capacity		Anti freezing		▼ Select	[↵] Confirm
System setup	12:00am, Mon												
Optional PCB connectivity													
Zone & Sensor													
Heater capacity													
Anti freezing													
▼ Select	[↵] Confirm												
<div style="border: 1px solid black; padding: 2px; display: inline-block; margin-bottom: 5px;"><b>2. Zone &amp; Sensor</b></div> <div style="border: 1px solid black; padding: 2px; display: inline-block; margin-left: 20px;">Initial setting: Room and Water temp.</div> <p>If no Optional PCB connectivity Select sensor of room temperature control from the following 3 items</p> <ol style="list-style-type: none"> <li>① Water temperature (Circulation water temperature)</li> <li>② Room thermostat (Internal or External)</li> <li>③ Room thermistor</li> </ol> <p>When there is Optional PCB connectivity</p> <ol style="list-style-type: none"> <li>① Select either 1 zone control or 2 zone control. If it is 1 zone, select either room or pool, select sensor If it is 2 zone, after select sensor of zone 1, select either room or pool for zone 2, select sensor</li> </ol> <p>(NOTE) In 2 zone system, pool function can be set at zone 2 only.</p>	<table border="1" style="width: 100%; border-collapse: collapse;"> <tr><td style="text-align: right;">System setup</td><td style="text-align: right;">12:00am, Mon</td></tr> <tr><td colspan="2" style="background-color: #f0f0f0;">Optional PCB connectivity</td></tr> <tr><td colspan="2" style="background-color: #f0f0f0;">Zone &amp; Sensor</td></tr> <tr><td colspan="2">Heater capacity</td></tr> <tr><td colspan="2">Anti freezing</td></tr> <tr><td style="text-align: right;">▲ Select</td><td style="text-align: right;">[↵] Confirm</td></tr> </table>	System setup	12:00am, Mon	Optional PCB connectivity		Zone & Sensor		Heater capacity		Anti freezing		▲ Select	[↵] Confirm
System setup	12:00am, Mon												
Optional PCB connectivity													
Zone & Sensor													
Heater capacity													
Anti freezing													
▲ Select	[↵] Confirm												
<div style="border: 1px solid black; padding: 2px; display: inline-block; margin-bottom: 5px;"><b>3. Heater capacity</b></div> <div style="border: 1px solid black; padding: 2px; display: inline-block; margin-left: 20px;">Initial setting: Depend on model</div> <p>If there is built-in Heater, set the selectable heater capacity.</p> <p>(NOTE) There are models which cannot select heater.</p>	<table border="1" style="width: 100%; border-collapse: collapse;"> <tr><td style="text-align: right;">System setup</td><td style="text-align: right;">12:00am, Mon</td></tr> <tr><td colspan="2" style="background-color: #f0f0f0;">Optional PCB connectivity</td></tr> <tr><td colspan="2" style="background-color: #f0f0f0;">Zone &amp; Sensor</td></tr> <tr><td colspan="2" style="background-color: #f0f0f0;">Heater capacity</td></tr> <tr><td colspan="2">Anti freezing</td></tr> <tr><td style="text-align: right;">▲ Select</td><td style="text-align: right;">[↵] Confirm</td></tr> </table>	System setup	12:00am, Mon	Optional PCB connectivity		Zone & Sensor		Heater capacity		Anti freezing		▲ Select	[↵] Confirm
System setup	12:00am, Mon												
Optional PCB connectivity													
Zone & Sensor													
Heater capacity													
Anti freezing													
▲ Select	[↵] Confirm												
<div style="border: 1px solid black; padding: 2px; display: inline-block; margin-bottom: 5px;"><b>4. Anti freezing</b></div> <div style="border: 1px solid black; padding: 2px; display: inline-block; margin-left: 20px;">Initial setting: Yes</div> <p>Operate anti-freezing of water circulation circuit. If select Yes, when the water temperature is reaching its freezing temperature, the circulation pump will start up. If the water temperature does not reach the pump stop temperature, back-up heater will be activated.</p> <p>(NOTE) If set No, when the water temperature is reaching its freezing temperature or below 0°C, the water circulation circuit may freeze and cause malfunction.</p>	<table border="1" style="width: 100%; border-collapse: collapse;"> <tr><td style="text-align: right;">System setup</td><td style="text-align: right;">12:00am, Mon</td></tr> <tr><td colspan="2" style="background-color: #f0f0f0;">Optional PCB connectivity</td></tr> <tr><td colspan="2" style="background-color: #f0f0f0;">Zone &amp; Sensor</td></tr> <tr><td colspan="2" style="background-color: #f0f0f0;">Heater capacity</td></tr> <tr><td colspan="2" style="background-color: #f0f0f0;">Anti freezing</td></tr> <tr><td style="text-align: right;">▲ Select</td><td style="text-align: right;">[↵] Confirm</td></tr> </table>	System setup	12:00am, Mon	Optional PCB connectivity		Zone & Sensor		Heater capacity		Anti freezing		▲ Select	[↵] Confirm
System setup	12:00am, Mon												
Optional PCB connectivity													
Zone & Sensor													
Heater capacity													
Anti freezing													
▲ Select	[↵] Confirm												
<div style="border: 1px solid black; padding: 2px; display: inline-block; margin-bottom: 5px;"><b>5. Tank connection</b></div> <div style="border: 1px solid black; padding: 2px; display: inline-block; margin-left: 20px;">Initial setting: No</div> <p>Select whether it is connected to hot water tank or not. If set Yes, it becomes setting that uses hot water function. Hot water temperature of tank can be set from main screen.</p>	<table border="1" style="width: 100%; border-collapse: collapse;"> <tr><td style="text-align: right;">System setup</td><td style="text-align: right;">12:00am, Mon</td></tr> <tr><td colspan="2" style="background-color: #f0f0f0;">Zone &amp; Sensor</td></tr> <tr><td colspan="2" style="background-color: #f0f0f0;">Heater capacity</td></tr> <tr><td colspan="2" style="background-color: #f0f0f0;">Anti freezing</td></tr> <tr><td colspan="2" style="background-color: #f0f0f0;">Tank connection</td></tr> <tr><td style="text-align: right;">▲ Select</td><td style="text-align: right;">[↵] Confirm</td></tr> </table>	System setup	12:00am, Mon	Zone & Sensor		Heater capacity		Anti freezing		Tank connection		▲ Select	[↵] Confirm
System setup	12:00am, Mon												
Zone & Sensor													
Heater capacity													
Anti freezing													
Tank connection													
▲ Select	[↵] Confirm												

<b>6. DHW Capacity</b>	Initial setting: Variable	<table border="1" style="width: 100%; border-collapse: collapse;"> <tr><td>System setup</td><td style="text-align: right;">12:00am, Mon</td></tr> <tr><td>Zone &amp; Sensor</td><td></td></tr> <tr><td>Heater capacity</td><td></td></tr> <tr><td>Anti freezing</td><td></td></tr> <tr style="background-color: #f0f0f0;"><td>DHW Capacity</td><td></td></tr> <tr><td style="text-align: center;">⬆ Select      [↵] Confirm</td><td></td></tr> </table>	System setup	12:00am, Mon	Zone & Sensor		Heater capacity		Anti freezing		DHW Capacity		⬆ Select      [↵] Confirm	
System setup	12:00am, Mon													
Zone & Sensor														
Heater capacity														
Anti freezing														
DHW Capacity														
⬆ Select      [↵] Confirm														

Variable DHW capacity setting normally run with efficient boiling which is energy saving heating. But while hot water usage high and tank water temperature low, variable DHW mode will run with fast heat up which heat up the tank with high heating capacity. If standard DHW capacity setting is selected, heat pump run with heating rated capacity at tank heat up operation.

<b>7. Buffer Tank connection</b>	Initial setting: No	<table border="1" style="width: 100%; border-collapse: collapse;"> <tr><td>System setup</td><td style="text-align: right;">12:00am, Mon</td></tr> <tr><td>Heater capacity</td><td></td></tr> <tr><td>Anti freezing</td><td></td></tr> <tr><td>Tank connection</td><td></td></tr> <tr style="background-color: #f0f0f0;"><td>Buffer tank connection</td><td></td></tr> <tr><td style="text-align: center;">⬆ Select      [↵] Confirm</td><td></td></tr> </table>	System setup	12:00am, Mon	Heater capacity		Anti freezing		Tank connection		Buffer tank connection		⬆ Select      [↵] Confirm	
System setup	12:00am, Mon													
Heater capacity														
Anti freezing														
Tank connection														
Buffer tank connection														
⬆ Select      [↵] Confirm														

Select whether it is connected to buffer tank for heating or not.  
 If buffer tank is used, please set Yes.  
 Connect buffer tank thermistor and set,  $\Delta T$  ( $\Delta T$  use to increase primary side temp against secondary side target temp).  
 (NOTE) Does not display if there is no Optional PCB.  
 If the buffer tank capacity is not so large, please set larger value for  $\Delta T$ .

<b>8. Tank heater</b>	Initial setting: Internal	<table border="1" style="width: 100%; border-collapse: collapse;"> <tr><td>System setup</td><td style="text-align: right;">12:00am, Mon</td></tr> <tr><td>Anti freezing</td><td></td></tr> <tr><td>Tank connection</td><td></td></tr> <tr><td>Buffer tank connection</td><td></td></tr> <tr style="background-color: #f0f0f0;"><td>Tank heater</td><td></td></tr> <tr><td style="text-align: center;">⬆ Select      [↵] Confirm</td><td></td></tr> </table>	System setup	12:00am, Mon	Anti freezing		Tank connection		Buffer tank connection		Tank heater		⬆ Select      [↵] Confirm	
System setup	12:00am, Mon													
Anti freezing														
Tank connection														
Buffer tank connection														
Tank heater														
⬆ Select      [↵] Confirm														

Select to use either built-in heater or external heater as heater for hot water tank.  
 If heater is installed on tank, please select External.  
 (NOTE) Does not display if there is no tank for hot water supply.  
 Please set "Tank heater" to "ON" in the "Function setup" from remote controller when using heater to boil the tank.

**External** A setting which is using booster heater installed on DHW tank to boil the tank.  
 The permissible heater capacity is 3kW and below.  
 The operation to boil the tank with heater is as below.  
 In addition, be sure to set suitable "Tank heater: ON time"

**For 65°C setting**

HP: [Bar from 53°C to 65°C]  
 Booster heater: [Bar from 53°C to 65°C]  
 Pump: [Bar from 53°C to 65°C]

**Internal** A setting which is using backup heater of Mono bloc to boil the tank.  
 The operation to boil the tank with heater is as below.

**For 65°C setting**

HP: [Bar from 53°C to 65°C]  
 Backup heater: [Bar from 53°C to 65°C]  
 Pump: [Bar from 53°C to 65°C]

<b>9. Base pan heater</b>	Initial setting: No	<table border="1" style="width: 100%; border-collapse: collapse;"> <tr><td>System setup</td><td style="text-align: right;">12:00am, Mon</td></tr> <tr><td>Tank connection</td><td></td></tr> <tr><td>Buffer tank connection</td><td></td></tr> <tr><td>Tank heater</td><td></td></tr> <tr style="background-color: #f0f0f0;"><td>Base pan heater</td><td></td></tr> <tr><td style="text-align: center;">⬆ Select      [↵] Confirm</td><td></td></tr> </table>	System setup	12:00am, Mon	Tank connection		Buffer tank connection		Tank heater		Base pan heater		⬆ Select      [↵] Confirm	
System setup	12:00am, Mon													
Tank connection														
Buffer tank connection														
Tank heater														
Base pan heater														
⬆ Select      [↵] Confirm														

Select whether Base pan heater is installed or not.  
 If set Yes, select to use either heater A or B.  
 A: Turn on Heater when heating with defrost operation only  
 B: Turn on Heater at heating

<b>10. Alternative outdoor sensor</b>	Initial setting: No	<table border="1" style="width: 100%; border-collapse: collapse;"> <tr><td>System setup</td><td style="text-align: right;">12:00am, Mon</td></tr> <tr><td>Buffer tank connection</td><td></td></tr> <tr><td>Tank heater</td><td></td></tr> <tr><td>Base pan heater</td><td></td></tr> <tr style="background-color: #f0f0f0;"><td>Alternative outdoor sensor</td><td></td></tr> <tr><td style="text-align: center;">⬆ Select      [↵] Confirm</td><td></td></tr> </table>	System setup	12:00am, Mon	Buffer tank connection		Tank heater		Base pan heater		Alternative outdoor sensor		⬆ Select      [↵] Confirm	
System setup	12:00am, Mon													
Buffer tank connection														
Tank heater														
Base pan heater														
Alternative outdoor sensor														
⬆ Select      [↵] Confirm														

Set Yes if outdoor sensor is installed.  
 Controlled by optional outdoor sensor without reading the outdoor sensor of heat pump unit.

## 11. Bivalent connection

Initial setting: No

System setup	12:00am, Mon
Tank heater	
Base pan heater	
Alternative outdoor sensor	
<b>Bivalent connection</b>	
⬆ Select	[↵] Confirm

Set if heat pump linked with boiler operation.  
 Connect the start signal of the boiler in boiler contact terminal (main PCB).  
 Set Bivalent connection to YES.  
 After that, please begin setting according to remote controller instruction.  
 Boiler icon will be displayed on remote controller top screen.

After Bivalent connection Set YES, there is two option of control pattern to be select, (SG Ready / Auto)

- 1) SG ready (Only available to set when Optional PCB set to YES)  
 - SG Ready input from Optional PCB terminal control ON/OFF of boiler and heat pump as below condition

SG signal		Operation pattern
Vcc-bit1	Vcc-bit2	
Open	Open	Heat pump OFF, Boiler OFF
Short	Open	Heat pump ON, Boiler OFF
Open	Short	Heat pump OFF, Boiler ON
Short	Short	Heat pump ON, Boiler ON

\* This bivalent SG ready input is sharing same terminal as [16. SG ready] connection. Only one of these two setting can be set at the same time. When one is set, another setting will reset to not set.

- 2) Auto (If Optional PCB no Set, bivalent control pattern will set to this auto as default value)

There are 3 different modes in the boiler operation. Movement of each modes are shown below.

- ① Alternative (switch to boiler operation when drops below setting temperature)
- ② Parallel (allow boiler operation when drops below setting temperature)
- ③ Advanced Parallel (able to slightly delay boiler operation time of parallel operation)

When the boiler operation is "ON", "boiler contact" is "ON", " " (underscore) will be displayed below the boiler icon.

Please set target temperature of boiler to be the same as heat pump temperature.

When boiler temperature is higher than heat pump temperature, zone temperature cannot be achieved if mixing valve is not installed.

This product only allows one signal to control the boiler operation. Operation setting of boiler shall be responsible by installer.

### Alternative mode

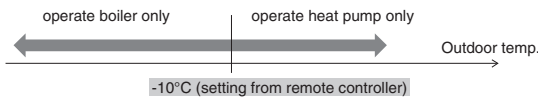

### Parallel mode

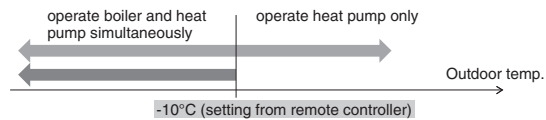

### Advanced Parallel mode

#### For heating

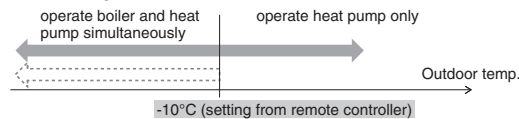

#### For DHW tank

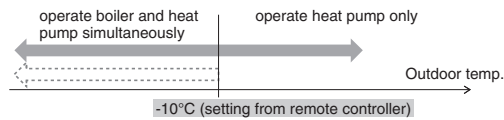

Although heat pump operates but water temperature does not reach this temperature for more than 30 mins (setting from remote controller)

AND

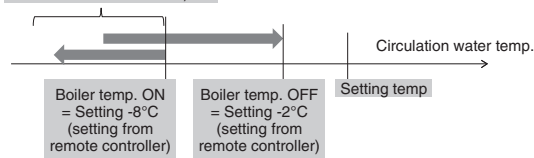

AND

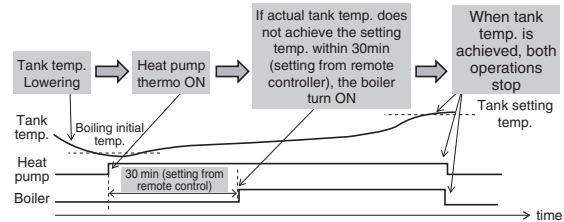

In Advanced Parallel mode, setting for both heating and tank can be made simultaneously. During operation of "Heating/Tank" mode, when each time the mode is switched, the boiler output will be reset to OFF. Please have good understanding on the boiler control characteristic in order to select the optimal setting for the system.

## 12. External SW

Initial setting: No

System setup	12:00am, Mon
Base pan heater	
Alternative outdoor sensor	
Bivalent connection	
<b>External SW</b>	
⬆ Select	[↵] Confirm

Able to turn ON/OFF the operation by external switch.



**13. Solar connection**

Initial setting: No

Set when solar water heater is installed.

Setting include items below.

- ① Set either buffer tank or DHW tank for connection with solar water heater.
- ② Set temperature difference between solar panel thermistor and buffer tank or DHW tank thermistor to operate the solar pump.
- ③ Set temperature difference between solar panel thermistor and buffer tank or DHW tank thermistor to stop the solar pump.
- ④ Anti-freezing operation start temperature (please change setting based on usage of glycol.)
- ⑤ Solar pump stop operation when it exceeds high limit temperature (when tank temperature exceed designated temperature (70~90°C))

System setup	12:00am, Mon
Alternative outdoor sensor	
Bivalent connection	
External SW	
<b>Solar connection</b>	
⬇ Select	[↩] Confirm

**14. External Error signal**

Initial setting: No

Set when external error display unit is installed.

Turn on Dry Contact SW when error happened.

(NOTE) Does not display when there is no Optional PCB.

When error occurs, error signal will be ON.

After turn off "close" from the display, error signal will still remain ON.

System setup	12:00am, Mon
Bivalent connection	
External SW	
Solar connection	
<b>External Error signal</b>	
⬇ Select	[↩] Confirm

**15. Demand control**

Initial setting: No

Set when there is demand control.

Adjust terminal voltage within 1 ~ 10 V to change the operating current limit.

(NOTE) Does not display when there is no Optional PCB.

System setup	12:00am, Mon
External SW	
Solar connection	
External Error signal	
<b>Demand control</b>	
⬇ Select	[↩] Confirm

Analog input [V]	Rate [%]	Analog input [V]	Rate [%]	Analog input [V]	Rate [%]
0.0	not activate	3.9 ~ 4.1	40	7.4 ~ 7.6	75
0.1 ~ 0.6		4.2	45	7.7	80
0.7	10 not activate	4.3	45	7.8	80
0.8		4.4 ~ 4.6		7.9 ~ 8.1	
0.9 ~ 1.1	10	4.7	50	8.2	85
1.2	15	4.8	50	8.3	85
1.3		4.9 ~ 5.1		8.4 ~ 8.6	
1.4 ~ 1.6	15	5.2	55	8.7	90
1.7	20	5.3	55	8.8	90
1.8		5.4 ~ 5.6		8.9 ~ 9.1	
1.9 ~ 2.1	20	5.7	60	9.2	95
2.2	25	5.8	60	9.3	95
2.3		5.9 ~ 6.1		9.4 ~ 9.6	
2.4 ~ 2.6	25	6.2	65	9.7	100
2.7	30	6.3	65	9.8	
2.8		6.4 ~ 6.6		9.9 ~	100
2.9 ~ 3.1	30	6.7	70		
3.2	35	6.8	70		
3.3		6.9 ~ 7.1			
3.4 ~ 3.6	35	7.2	75		
3.7	40	7.3	70		
3.8					

\*A minimum operating current is applied on each model for protection purpose.  
 \*0.2 voltage hysteresis is provided.  
 \*The value of voltage after 2nd decimal point are cut off.

**16. SG ready**

Initial setting: No

Switch operation of heat pump by open-short of 2 terminals. Setting belows are possible

SG signal		Working pattern
Vcc-bit1	Vcc-bit2	
Open	Open	Normal
Short	Open	Heat pump and Heater OFF
Open	Short	Capacity 1
Short	Short	Capacity 2

Capacity setting 1

- DHW capacity \_\_\_%
- Heating capacity \_\_\_%
- Cooling capacity \_\_\_°C

Capacity setting 2

- DHW capacity \_\_\_%
- Heating capacity \_\_\_%
- Cooling capacity \_\_\_°C

} Set by SG ready setting of remote controller

(When SG ready set to YES, Bivalent control pattern will set to Auto.)

System setup	12:00am, Mon
Solar connection	
External Error signal	
Demand control	
<b>SG ready</b>	
⬇ Select	[↩] Confirm

<b>17. External Compressor SW</b>	Initial setting: No	System setup 12:00am, Mon					
<p>Set when external compressor SW is connected. SW is connected to external devices to control power consumption, Open Signal will stop compressor's operation. (Heating operation etc. are not cancelled).</p> <p>(NOTE) Does not display if there is no Optional PCB.</p> <p>If follow Swiss standard power connection, need to turn on DIP SW (SW2 pin3) of main unit PCB. Short/Open signal used to ON/OFF tank heater (for sterilization purpose)</p>		<table border="1" style="width: 100%; border-collapse: collapse;"> <tr><td>External Error signal</td></tr> <tr><td>Demand control</td></tr> <tr><td>SG ready</td></tr> <tr style="background-color: #f0f0f0;"><td><b>External compressor SW</b></td></tr> <tr><td>⬆ Select [↩] Confirm</td></tr> </table>	External Error signal	Demand control	SG ready	<b>External compressor SW</b>	⬆ Select [↩] Confirm
External Error signal							
Demand control							
SG ready							
<b>External compressor SW</b>							
⬆ Select [↩] Confirm							

<b>18. Circulation Liquid</b>	Initial setting: Water	System setup 12:00am, Mon					
<p>Set circulation of heating water.</p> <p>There are 2 types of settings, water and glycol.</p> <p>(NOTE) Please set glycol when using anti-freeze liquid. It may cause error if setting is wrong.</p>		<table border="1" style="width: 100%; border-collapse: collapse;"> <tr><td>Demand control</td></tr> <tr><td>SG ready</td></tr> <tr><td>External compressor SW</td></tr> <tr style="background-color: #f0f0f0;"><td><b>Circulation liquid</b></td></tr> <tr><td>⬆ Select [↩] Confirm</td></tr> </table>	Demand control	SG ready	External compressor SW	<b>Circulation liquid</b>	⬆ Select [↩] Confirm
Demand control							
SG ready							
External compressor SW							
<b>Circulation liquid</b>							
⬆ Select [↩] Confirm							

<b>19. Heat-Cool SW</b>	Initial setting: Disable	System setup 12:00am, Mon					
<p>Able to switch (fix) heating &amp; cooling by external switch.</p> <p>(Open) : Fix at Heating (Heating +DHW) (Short) : Fix at Cooling (Cooling +DHW)</p> <p>(NOTE) This setting is disabled for model without Cooling. (NOTE) Does not display if there is no Optional PCB.</p> <p>Timer function cannot be used. Cannot use Auto mode.</p>		<table border="1" style="width: 100%; border-collapse: collapse;"> <tr><td>SG ready</td></tr> <tr><td>External compressor SW</td></tr> <tr><td>Circulation liquid</td></tr> <tr style="background-color: #f0f0f0;"><td><b>Heat-Cool SW</b></td></tr> <tr><td>⬆ Select [↩] Confirm</td></tr> </table>	SG ready	External compressor SW	Circulation liquid	<b>Heat-Cool SW</b>	⬆ Select [↩] Confirm
SG ready							
External compressor SW							
Circulation liquid							
<b>Heat-Cool SW</b>							
⬆ Select [↩] Confirm							

<b>20. Force Heater</b>	Initial setting: Manual	System setup 12:00am, Mon					
<p>Under manual mode, user can turn on force heater through quick menu.</p> <p>If selection is 'auto', force heater mode will turn automatically if pop up error happen during operation.</p> <p>Force heater will operate follow the latest mode selection, mode selection is disable under force heater operation.</p> <p>Heater source will ON during force heater mode.</p>		<table border="1" style="width: 100%; border-collapse: collapse;"> <tr><td>External compressor SW</td></tr> <tr><td>Circulation liquid</td></tr> <tr><td>Heat-Cool SW</td></tr> <tr style="background-color: #f0f0f0;"><td><b>Force Heater</b></td></tr> <tr><td>⬆ Select [↩] Confirm</td></tr> </table>	External compressor SW	Circulation liquid	Heat-Cool SW	<b>Force Heater</b>	⬆ Select [↩] Confirm
External compressor SW							
Circulation liquid							
Heat-Cool SW							
<b>Force Heater</b>							
⬆ Select [↩] Confirm							

<b>21. Force Defrost</b>	Initial setting: Manual	System setup 12:00am, Mon					
<p>Under manual code, user can turn on force defrost through quick menu.</p> <p>If selection is 'auto', outdoor unit will run defrost operation once if heat pump have long hour of heating without any defrost operation before at low ambient condition. (Even auto is selected, user still can turn on force defrost through quick menu)</p>		<table border="1" style="width: 100%; border-collapse: collapse;"> <tr><td>Circulation liquid</td></tr> <tr><td>Heat-Cool SW</td></tr> <tr><td>Force heater</td></tr> <tr style="background-color: #f0f0f0;"><td><b>Force defrost</b></td></tr> <tr><td>⬆ Select [↩] Confirm</td></tr> </table>	Circulation liquid	Heat-Cool SW	Force heater	<b>Force defrost</b>	⬆ Select [↩] Confirm
Circulation liquid							
Heat-Cool SW							
Force heater							
<b>Force defrost</b>							
⬆ Select [↩] Confirm							

<b>22. Defrost signal</b>	Initial setting: No	System setup 12:00am, Mon					
<p>Defrost signal sharing same terminal as bivalent contact in main board. When defrost signal set to YES, bivalent connection reset to NO. Only one function can be set between defrost signal and bivalent.</p> <p>When defrost signal set to YES, during defrost operation is running at outdoor unit defrost signal contact turn ON. Defrost signal contact turn OFF after defrost operation end. (Purpose of this contact output is to stop indoor fan coil or water pump during defrost operation).</p>		<table border="1" style="width: 100%; border-collapse: collapse;"> <tr><td>Heat-Cool SW</td></tr> <tr><td>Force heater</td></tr> <tr><td>Force defrost</td></tr> <tr style="background-color: #f0f0f0;"><td><b>Defrost signal</b></td></tr> <tr><td>⬆ Select [↩] Confirm</td></tr> </table>	Heat-Cool SW	Force heater	Force defrost	<b>Defrost signal</b>	⬆ Select [↩] Confirm
Heat-Cool SW							
Force heater							
Force defrost							
<b>Defrost signal</b>							
⬆ Select [↩] Confirm							

<b>23. Pump flowrate</b>	Initial setting: ΔT	System setup 12:00am, Mon					
<p>If pump flowrate setting is ΔT, unit adjust pump duty to get different of water inlet and outlet base on setting on * ΔT for heating ON and * ΔT for cooling ON in operation setup menu during room side operation.</p> <p>If pump flowrate setting is set to Max. duty, unit will set the pump duty to the set duty at *Pump maximum speed in service setup menu during room side operation.</p>		<table border="1" style="width: 100%; border-collapse: collapse;"> <tr><td>Force heater</td></tr> <tr><td>Force defrost</td></tr> <tr><td>Defrost signal</td></tr> <tr style="background-color: #f0f0f0;"><td><b>Pump flowrate</b></td></tr> <tr><td>⬆ Select [↩] Confirm</td></tr> </table>	Force heater	Force defrost	Defrost signal	<b>Pump flowrate</b>	⬆ Select [↩] Confirm
Force heater							
Force defrost							
Defrost signal							
<b>Pump flowrate</b>							
⬆ Select [↩] Confirm							

## 12.4.4 Operation Setup

### Heat

**24. Water temp. for heating ON**      Initial setting: compensation curve

Set target water temperature to operate heating operation.  
 Compensation curve: Target water temperature change in conjunction with outdoor ambient temperature change.  
 Direct: Set direct circulation water temperature.

In 2 zone system, zone 1 and zone 2 water temperature can be set separately.

**25. Outdoor temp. for heating OFF**      Initial setting: 24°C

Set outdoor temp to stop heating.  
 Setting range is 5°C ~ 35°C

**26. ΔT for heating ON**      Initial setting: 5°C

Set temp difference between out temp & return temp of circulating water of Heating operation.  
 When temp gap is enlarged, it is energy saving but less comfort. When the gap gets smaller, energy saving effect gets worse but it is more comfortable.  
 Setting range is 1°C ~ 15°C

**27. Heater ON/OFF**

a. Outdoor temp. for heater ON      Initial setting: 0°C

Set outdoor temp when back-up heater starts to operate.  
 Setting range is -20°C ~ 15°C

User shall set whether to use or not to use heater.

b. Heater ON delay time      Initial setting: 30 minutes

Set delay time from compressor ON for heater to turn ON if not achieve water set temperature.  
 Setting range is 10 minutes ~ 60 minutes

c. Heater ON: ΔT of target Temp      Initial setting: -4°C

Set water temperature for heater to turn on at heat mode.  
 Setting range is -10°C ~ -2°C

d. Heater OFF: ΔT of target Temp      Initial setting: -2°C

Set water temperature for heater to turn off at heat mode.  
 Setting range is -8°C ~ 0°C

### Cool

**28. Water temp. for cooling ON**      Initial setting: Compensation curve

Set target water temperature to operate cooling operation.  
 Compensation curve: Target water temperature change in conjunction with outdoor ambient temperature change.  
 Direct: Set direct circulation water temperature.

In 2 zone system, zone 1 and zone 2 water temperature can be set separately.

**29. ΔT for cooling ON**      Initial setting: 5°C

Set temp difference between out temp & return temp of circulating water of Cooling operation.  
 When temp gap is enlarged, it is energy saving but less comfort. When the gap gets smaller, energy saving effect gets worse but it is more comfortable.  
 Setting range is 1°C ~ 15°C

## Auto

**30. Outdoor temp. for (Heat to Cool)** Initial setting: 15°C

Set outdoor temp that switches from heating to cooling by Auto setting.  
Setting range is 5°C ~ 25°C  
Timing of judgement is every 1 hour

**31. Outdoor temp. for (Cool to Heat)** Initial setting: 10°C

Set outdoor temp that switches from Cooling to Heating by Auto setting.  
Setting range is 5°C ~ 25°C  
Timing of judgement is every 1 hour

## Tank

**32. Floor operation time (max.)** Initial setting: 8h

Set max operating hours of heating.  
When max operation time is shortened, it can boil the tank more frequently.  
It is a function for Heating + Tank operation.

**33. Tank heat up time (max.)** Initial setting: 60min

Set max boiling hours of tank.  
When max boiling hours are shortened, it immediately returns to Heating operation, but it may not fully boil the tank.

**34. Tank re-heat temp.** Initial setting: -8°C

Set temp to perform reboil of tank water.  
Setting range is -12°C ~ -2°C

**35. Sterilization** Initial setting: 65°C 10min

Set timer to perform sterilization.  
① Set operating day & time. (Weekly timer format)  
② Sterilization temp (55~75°C \* If use back-up heater, it is 65°C)  
③ Operation time (Time to run sterilization when it reached setting temp 5min ~ 60min)  
User shall set whether to use or not to use sterilization mode.

## 12.4.5 Service Setup

**36. Pump maximum speed** Initial setting: Depend on model

Normally setting is not necessary.  
Please adjust when need to reduce the pump sound etc.  
Besides that, it has Air Purge function.  
When \*Pump flow setting is Max. Duty, this duty set is the fix pump duty run during room side operation.

Service setup	12:00am, Mon	
Flow rate	Max. Duty	Operation
88:8 L/min	0xCE	<b>Air Purge</b>
Select		

**37. Pump down**

Operate pump down operation

Service setup	12:00am, Mon
Pump down:	ON
[←] Confirm	

Pump down operation in progress!
[⏻] OFF

**38. Dry concrete**

Operate concrete curing operation.  
Select Edit, set temp for every stage (1~99 1 is for 1 day).  
Setting range is 25~55°C  
When it is turned ON, dry concrete starts.  
When it is 2 zone, it dries both zones.

**39. Service contact**

Able to set name & tel no. of contact person when there is breakdown etc. or client has trouble. (2 items)

Service setup	12:00am, Mon	Contact-1: Bryan Adams
Service contact:	Contact 1	ABC/ abc 0-9/ Other
	Contact 2	A B C D E F G H I J K L M N O P Q R
		S T U V W X Y Z a b c d e f g h i
		j k l m n o p q r s t u v w x y z
▲ Select	[←] Confirm	▼ Select [←] Enter

## 12.5 Service and maintenance

### If forget Password and cannot operate remote controller

Press + + for 5 sec.  
 Password unlock screen appears, press Confirm and it shall reset.  
 Password will become 0000. Please reset it again.  
 (NOTE) Only display when it is locked by password.

### Maintenance menu

#### Setting method of Maintenance menu

Maintenance menu	12:00am, Mon
<b>Actuator check</b>	
Test mode	
Sensor setup	
Reset password	
▼ Select	[↵] Confirm

Press + + for 5 sec.

Items that can be set

- ① Actuator check (Manual ON/OFF all functional parts)  
 (NOTE) As there is no protection action, please be careful not to cause any error when operating each part (do not turn on pump when there is no water etc.)
- ② Test mode (Test run)  
 Normally it is not used.
- ③ Sensor setup (offset gap of detected temp of each sensor within -2~2°C range)  
 (NOTE) Please use only when sensor is deviated.  
 It affects temperature control.
- ④ Reset password (Reset password)

### Custom menu

#### Setting method of Custom menu

Custom menu	12:00am, Mon
<b>Cool mode</b>	
Back-up heater	
Reset energy monitor	
Reset operation history	
▼ Select	[↵] Confirm

Please press + + for 10 sec.

Items that can be set

- ① Cool mode (Set With/Without Cooling function) Default is without  
 (NOTE) As with/without Cool mode may affect electricity application, please be careful and do not simply change it.  
 In Cool mode, please be careful if piping is not insulated properly, dew may form on pipe and water may drip on the floor and damage the floor.
- ② Backup heater (Use/Do not use Backup heater)  
 (NOTE) It is different from to use/not to use backup heater set by client. When this setting is used, heater power on due to protection against frost will be disabled. (Please use this setting when it is required by utility company.)  
 By using this setting, it cannot defrost due to low Heating's setting temp and operation may stop (H75)  
 Please set under the responsibility of installer.  
 When it stops frequently, it may be due to insufficient circulation flow rate, setting temp of heating is too low etc.
- ③ Reset energy monitor (delete memory of Energy monitor)  
 Please use when moving house and handover the unit.
- ④ Reset operation history (delete memory of operation history).  
 Please use when moving house and handover the unit.

## 13. Installation and Servicing Air Conditioner using R32

### 13.1 About R32 Refrigerant

For air conditioning refrigerants such as R410A, the refrigerants were collected back in order to prevent their air dissipation, to curbe the global warming impact, in case they were released into the atmosphere. In the “4th Environmental Basic Plan”, 80% reduction of greenhouse gas emissions by 2050 is required, and due to this requirement, further reduction in the emission of high greenhouse effect gas, such as CFCs, is required. Therefore, the conversion of air conditioning refrigerant into the ones who has smaller greenhouse effect, even if it is dissipated into the atmosphere, became our responsibility.

Nevertheless, in case of air conditioning refrigerant, it would be the best if there is a refrigerant which has smaller impact on global warming, but ensures good energy efficiency and performance, and is safe; however, there is no such refrigerant which satisfies all these conditions. As a result, we have been considering the practical usage, within the safety frame-work, of R32 refrigerant which has short lifetime in the atmosphere, and has smaller effect of global warming, but is slightly flammable.

In 2004, due to the revision of air conditioner safety standards by the International Electro-safety Commission (IEC), the safety standards of air conditioners using slightly flammable refrigerant was issued. In 2010, the regulations of American Society of Heating, Refrigerating and Air-Conditioning Engineers in the United States (ANSI/ASHRAE34) was issued adopting the grades for refrigerants which are difficult to inflame due to their slow burning rates, and as a result have smaller damages in cases of fire. The burning rate of R32 is lower by 10cm / per second, and safety standardization for various usage is now being processed.

### 13.2 Characteristics of R32 Refrigerant

#### 1. Chemical Characteristics

R32 is one of the refrigerants used in R410A, has almost no toxicity, and chemically stable compound formed by hydrogen, carbon and fluorine.

R32 has short lifetime of 4 to 9 years in case of being released into the atmosphere; therefore, it has smaller greenhouse gas effect but has slight inflammability because of the large proportion of hydrogen.

Chemical Characteristic Table of R32, R410A and R22.

	R32	R410A	R22
Chemical Formula	CH <sub>2</sub> F <sub>2</sub>	CH <sub>2</sub> F <sub>2</sub> / CHF <sub>2</sub> CF <sub>3</sub>	CH <sub>2</sub> ClF
Composition (mixture ratio wt.%)	Single Composition	R32 / R125A (50 / 50 wt.%)	Single Composition
Boiling Point (°C)	-51.7	-51.5	-40.8
Pressure (physical) *1	3.14	3.07	1.94
Capacity (physical) *2	160	141	100
COP (physical) *3	95	91	100
Ozone Depletion Potential (ODP)	0	0	0.055
Global Warming Potential (GWP) *4	675	2090	1810
Inflammability *5	Slightly Inflammable (A2L)	Non-inflammable (A1)	Non-inflammable (A1)
Toxicity	None	None	None

\*1 : Physical property of temperature condition 50°C

\*2 : Relative value of temperature condition 0/50°C, providing R22=100

\*3 : Te/Tc/SC/SH=5/50/3/0°C

\*4 : GWP=Global Warming Potential, each figure is based on “4<sup>th</sup> IPCC4 Report”

\*5 : Based on ANSI / ASHRAE std. 34-2010

## 2. Characteristic of Pressure

As shown in Table 2, R32 does not have much difference in vapor pressure at the same refrigerant temperature comparing to R410A, but comparing to R22, it is higher at 1.6 times more. Thus, the same as in case of R410A, it is necessary to do installation and service using high-pressure tools and components.

Table 2. Saturated vapor pressure comparison table

(Unit: MPa)

Temperature	Refrigerant		
	R32	R410A	R22
-20	0.30	0.30	0.14
0	0.71	0.70	0.40
20	1.37	1.35	0.81
40	2.38	2.32	1.43
60	3.84	3.73	2.33
65	4.29	4.17	2.60

Reference : Thermal properties table of Japan Society of Refrigerating and Air Conditioning Engineers (60, 65°C)  
NIST REFPROP V8.0 (-20 ~ 40°C)

## 13.3 Refrigerant piping installation • Tools used in services

### 13.3.1 Required Tools

R32 refrigerant air conditioners use the common parts as R410A air conditioners for two-way valves and three-way valves (diameters of service ports); thus, they maintain commonality in the maintenance of the compressive strength, the size of pipe flaring, and the size of flare nuts as R410A. Therefore, for refrigerant pipe installation and services, you can use tools for R410A.

However, mixing of refrigerants is not allowed, so that you have to separate the cylinders for the recovery of refrigerants.

Tools used for installation • relocation • replacement of air conditioning units

Works	R32	R410A	R22
Flaring	Flare tools for R410A (clutch type)		Flare tools for R22 (clutch type)
Connection of pipes	Torque wrench (diameter 1/4 3/8)		
	Torque wrench (diameter 1/2 5/8) *1		Toque wrench (diameter 1/2 5/8)
Manifold gauge charging hose	R32 & R410A Common (As at November 2013)		R22 Only
Air purging	Vacuum pump + Reducer / expander		Vacuum pump
Gas leakage test	Detection liquid or soup water, HFC detector		

\*1. Nut diameters of 1/2 5/8, the size of torque wrench common with R410A

For other installation, you can use general tools such as screw drivers (+, -), metal saws, electric drills, long-nose pliers, hole core drills ( $\varnothing 70$  or  $\varnothing 65$ ), linen tape, levels, temperature gauges, clamp meters, electric knives, nippers, pipe cutters, reamers or scrapers, spring benders, (diameters 1/4 3/8 1/2 5/8), monkey wrenches, fixing wrenches (17 or 12 mm), feeler gauges, hexagon wrenches (4 mm), testers, megohm testers, etc.

Tools used for services

Works	R32	R410A	R22
Insertion of refrigerant	Digital scale for refrigerant charging, refrigerant cylinders, cylinder adopters and packing *a		
Recovery of refrigerant	Refrigerant recovery devices, refrigerant cylinders, manifold gauges, charging hoses *b		

\*a. Use cylinder for each refrigerant, cylinder adopter and packing.

\*b. Use refrigerant recovery cylinder separately for each refrigerant (**no mixture of refrigerant allowed**). Please be aware that there are some refrigerant collection devices which do not have self-certification.

#### 1.1.1 Tools for R32 (common with R410A)

##### 1. Flare gauges

Use flare gauges when you perform flaring with flare tools (crutch type). Flare gauges are used to set the pipe ends at 0.5 ~ 1.5 mm from clump bars of flare tools.

Flare gauges



##### 2. Flare tools (clutch type)

Flare tools have larger holes of clump bars in order to set the pipe end at 0 ~ 0.5 mm, and have stronger springs inside to ensure solid flaring torques. These flare tools can be used commonly for R22.

Flare tools (clutch type)





3. Torque wrenches (diameters 1/2, 5/8)  
 In order to strengthen the compressive strength, the diameters of wrenches change depending on the flare nut sizes.

Torque wrenches

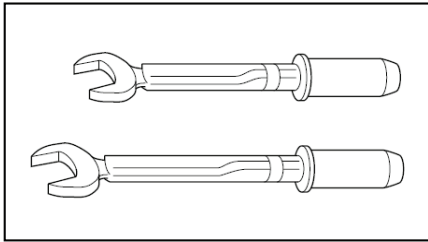

Differences in torque wrenches

	R32 (common R410A)	R22
1/2 (diameter × torque)	26 mm × 55 N•m (550 kgf•cm)	24 mm × 55 N•m (550 kgf•cm)
5/8 (diameter × torque)	29 mm × 65 N•m (650 kgf•cm)	27 mm × 65 N•m (650 kgf•cm)

4. Manifold gauges

R22 gauges cannot be used because of the high pressures.

Each port of manifold has different shapes in order to prevent inserting wrong refrigerant.

\*However, the port shape for R410A and R32 is the same; therefore, attention need to be paid not to insert wrong refrigerant.

Differences in high/low pressure gauges

	R32 (common R410A)	R22
High pressure gauges (red)	-0.1 ~ 5.3 MPa -76 cmHg ~ 53 kgf / cm <sup>2</sup>	-76 cmHg ~ 35 kgf / cm <sup>2</sup>
Low pressure gauges (blue)	-0.1 ~ 3.8 MPa -76 cmHg ~ 38 kgf / cm <sup>2</sup>	-76 cmHg ~ 17 kgf / cm <sup>2</sup>

Difference in manifold port sizes

	R32 (common R410A)	R22
Port sizes	1/2 UNF20	7/16 UNF20

5. Charging hoses

The pressure resistance of charge hoses is increased. At the same time, the material is changed to HFC resistant, and the size of each manifold adopter is changed, as the port size of manifold gauge itself. Further, some hoses are with anti-gas pressure backflow valves placed near the adopters. (hoses with the valves recommended)

Manifold gauges / Charging hoses

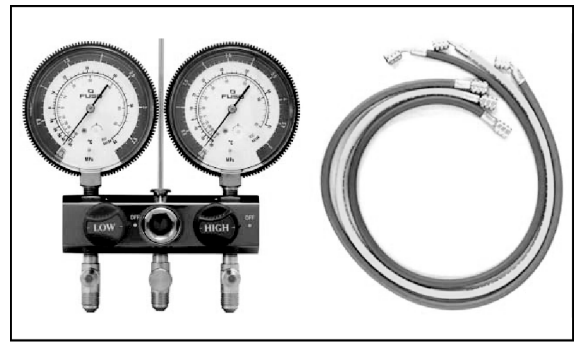

Differences in charging hoses

		R32 (common R410A)	R22
Pressure Resistance	Normal operation pressure	5.1 MPa (52 kgf / cm <sup>2</sup> )	3.4 MPa (35 kgf / cm <sup>2</sup> )
	Burst pressure	27.4 MPa (280 kgf / cm <sup>2</sup> )	17.2 MPa (175 kgf / cm <sup>2</sup> )
Material		HNBR rubber Internal nylon coating	NBR rubber

6. Vacuum pump and Vacuum pump adopter

When using a vacuum pump, it is necessary to set a solenoid valve in order to prevent backflow of vacuum pump oil into the charge hoses, and use a vacuum pump with oil backflow prevention function, or use the vacuum pump with vacuum pump adopter.

If vacuum pump oil ( mineral oil-based ) mixes with R410A (R32), it may cause damage to the machine.

Vacuum pump

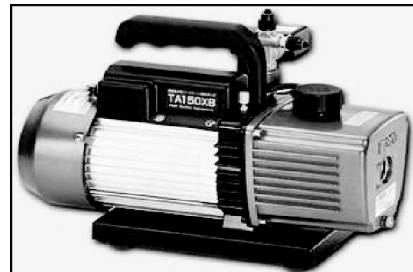

Vacuum pump adopter

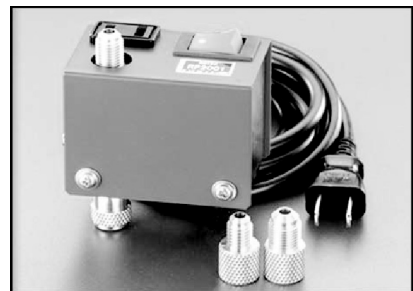

7. HFC refrigerant\_Electric gas leakage tester  
 R32 refrigerant is often used for other mixed refrigerant (R410A, R404A, R407C etc.). Therefore, the usage of existing HFC detectors is possible, but in order to detect more accurately, we recommend to use detectors specially set and adjusted for R32 detection.

HFC refrigerant\_Electric gas leakage tester



8. Digital scale for refrigerant charging  
 R32 and R410A have high pressure level and their evaporation speed is high. Thus, if you recover the refrigerant by cylinder charging method, the refrigerant evaporates within the weighing scale glass, which makes reading the scale difficult, rather than liquidating the refrigerant into the cylinder. (Charging cylinders for R22 have different pressure resistance, scale, connection port size; therefore, they are not usable) At the same time, the digital scale for refrigerant charging is strengthened by receiving the weight of the refrigerant cylinders with four pillars at the corners. The connection ports of charging hoses have two separate ports for R22 (7/16 UNF20) and R32/R410A (1/2 UNF20) therefore, they can be used for the insertion of the existing refrigerants.

Digital scale for refrigerant charging



9. Refrigerant cylinders  
 Refrigerant cylinders for R410A are painted in pink, and the ones for R32 are painted in other colors that might subject to change according to the international standards. R32 is a single refrigerant, so that both liquid and gas insertion are possible. Additional charging is also possible. (R410A is a mixed refrigerant, so only liquid insertion is possible)

Refrigerant cylinders



10. Connection ports of refrigerant cylinders and packing  
 Charging ports which fit to the charging hose connection port size (1/2 UNF20) is needed. At the same time, the packing has to be of HFC resistant materials.

Connection ports and packing



## 11. Tools used for refrigerant piping installations and services

	Tools for R410A	Common with R32	Possibility of usage for R22
1.	Pipe cutters, reamers or scrapers	○	○
2.	Flare tools (clutch type)	○	○
3.	Torque wrench (1/4, 3/8)	○	○
4.	Torque wrench (1/2, 5/8)	○	✕
5.	Manifold gauges · charging hoses	○	✕
6.	Vacuum pumps, vacuum pump adopters	○ Connection 5/16	○ Connection 1/4
7.	Electric gas leakage testers for HFC *1	○	△
8.	Digital scale for refrigerant charging	○	○
9.	HCF recovery devices (connection port 5/16) *2	○ Connection 5/16	○ Connection 1/4
10.	Refrigerant cylinders (pressure resistant: FC3)	Same specs ✕	✕
11.	Refrigerant cylinders (pink)	Other (colors that might subject to change according to the international standards).	✕
12.	Refrigerant cylinder connection ports and packing	○	✕
13.	Allen wrench (4 mm) Electric knives	○	○
*1	Those testers only for HCFC22 (R22), but not for HCF32 (R32) and HCF410A (R410A) cannot be for common use.		
*2	Recovery devices which are self-certified for each HCF type can be used.		
	<p>[Knowledge for the common usage of tools for R410A &amp; R32]</p> <ul style="list-style-type: none"> <li>• R410A and R32 machines use different compressor oils.</li> <li>• If unregulated compressor oil gets mixed into, it may cause damage to the machine function.</li> <li>• Careful pump down will ensure the recovery of compressor oil, and it will minimize the remaining amount of the oil in the manifold gauge and charging hose.</li> <li>• If you only perform the recovery of refrigerant and not be able to perform pump down, <u>you have to dispose the compressor oil in the charging hose.</u></li> </ul>		
	<p>[Precaution of repairing refrigerant cycle]</p> <ul style="list-style-type: none"> <li>• In the brazing, open 2-way and 3-way valves, and make sure the refrigerant is completely recovered back and not remaining the system.</li> <li>• When repairing outside, make sure no refrigerant is in the air, ensure good air flow, and perform the brazing.</li> </ul>		
	<p>[Inserting wrong refrigerant]</p> <ul style="list-style-type: none"> <li>• It may cause "not cooling" and "not heating" customer claims because each component (expansion valve, compressor, PCB) of the refrigeration cycle is specially adjusted for R32.</li> <li>• At the same time, it is not subject to product warranty, if wrong refrigerant was inserted into the system.</li> </ul>		

### 13.4 New installation, Relocation, Repairing of Refrigerant Cycle System The Procedures

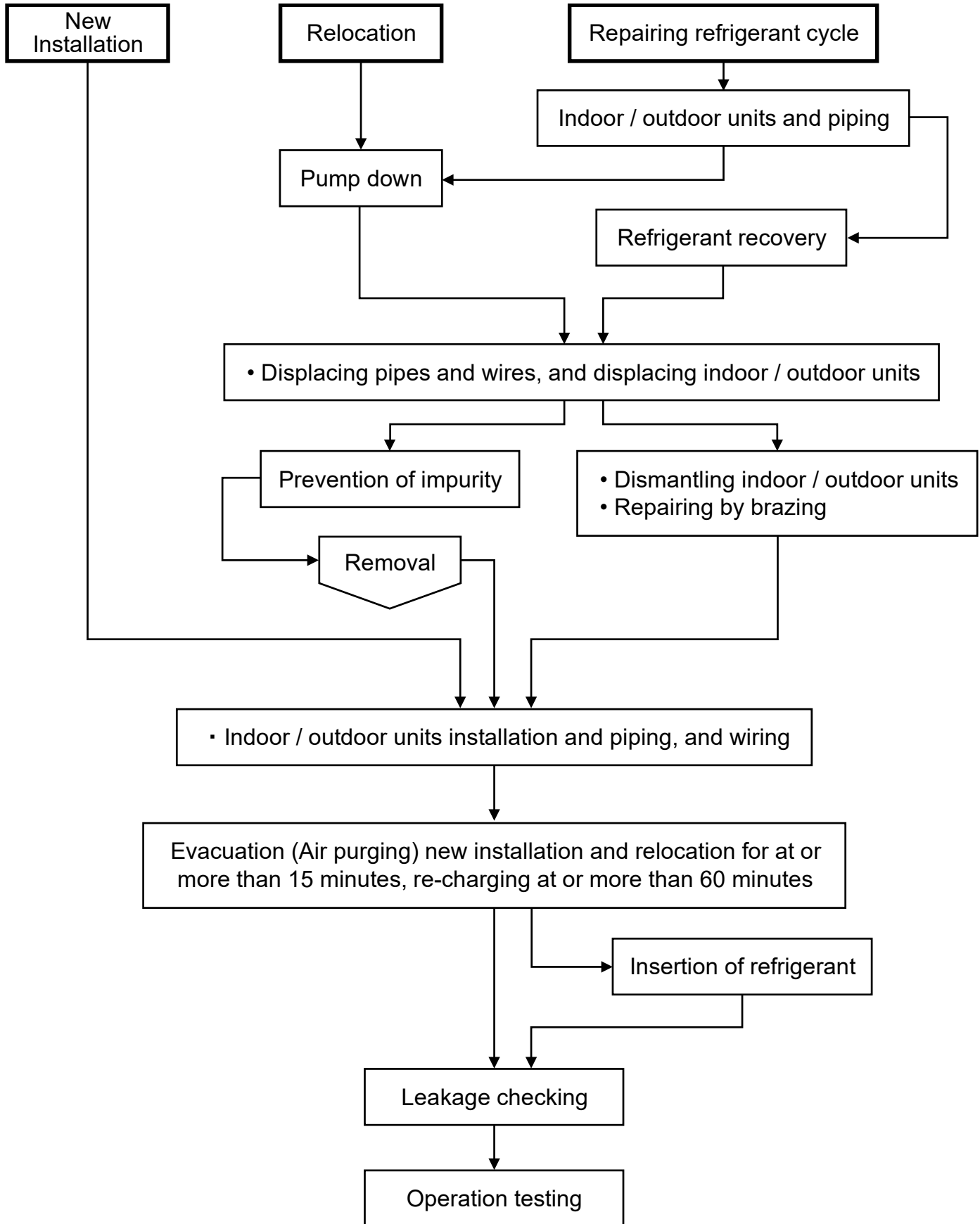

## 13.5 Piping installation of R32

### 13.5.1 Pipe materials used and flaring

Copper pipes are used for refrigerant piping. Pipes which comply with JIS Regulations need to be used. Room air conditioners which use R410A and R32 have higher pressure; thus, using pipes which comply with the Regulations is important.

The pipe thickness is regulated by revised JIS B 8607 "Flaring and brazing fittings for refrigerant" and the pipe thickness for R410A, R32 is shown in the table.

Pipe thickness

O and OL materials		Thickness (mm)		
Diameter	Diameter (mm)	R410A	R32	R22
1/4	6.35	0.80		
3/8	9.52	0.80		
1/2	12.70	0.80		
5/8	15.88	1.00		

#### Caution

- For connection piping, use copper phosphate seamless pipes (1220T) as regulated in "JIS H 3300" and the pipe thickness is 0.8 mm.
- In the market, there are some pipes of 0.7 mm thickness, but do not use these pipes (0.8 mm thickness has to be strictly followed).
- It is recommended to use pipes whose adhesion amount of oil is at or less than 40 mg / 10 m. At the same time, do not use pipes with dent, de-shape, and color change (especially inside).

### 13.5.2 Processing and connection of pipes

For refrigerant pipe installation, be aware of moisture and dirt do not get into the pipes, and make sure of no refrigerant leakage.

◎ The procedure of flaring and precautions

- Cutting of pipes : use pipe cutter and cut the pipe slowly not to de-shape the pipe.
- Removal of burrs on the edge of pipe (reamer or scraper)  
If the condition of pipe edge after the deburring is no good or if burrs attaches on the flaring, it may cause refrigerant leakage. Turn the pipe end down and perform deburring carefully.
- Insert the flare nut (use the nut which is a part of the CZ parts)
- Flaring

Ensure the cleanliness of clump bar and pipe, and perform flaring carefully.

Use the existing flare tools or flare tools for R410A. Be aware that the sizes and dimensions of flaring is different in each flaring tool. If you use the existing flaring tools, use flaring gauge to measure the length of the flaring part.

Piping size (mm)	Dimensions "a" (mm) R22			Dimensions "a" (mm) R410A/R32		
	Flare tools		Flare tools for R410A	Flare tools		Flare tools for R410A
	Clutch type	Wing nut type	Clutch type	Clutch type	Wing nut type	Clutch type
6.35 (1/4")	0.5 ~ 1.0	1.0 ~ 1.5	0 ~ 0.5	1.0 ~ 1.5	1.5 ~ 2.0	0 ~ 0.5
9.52 (3/8")	0.5 ~ 1.0	1.0 ~ 1.5	0 ~ 0.5	1.0 ~ 1.5	1.5 ~ 2.0	0 ~ 0.5
12.70 (1/2")	0.5 ~ 1.0	1.5 ~ 2.0	0 ~ 0.5	1.0 ~ 1.5	2.0 ~ 2.5	0 ~ 0.5
15.88 (5/8")	0.5 ~ 1.0	1.5 ~ 2.0	0 ~ 0.5	1.0 ~ 1.5	2.0 ~ 2.5	0 ~ 0.5

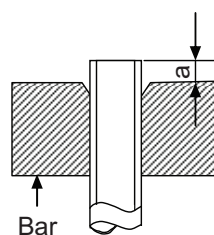

Nut outer diameter (mm)	
R22	R410A
	R32
17	17
22	22
24	26
27	29

## 13.6 Installation, Relocation, and Service

### 13.6.1 Air purge and gas leak test for new installation (using new refrigerant pipes) using vacuum pump

(From the point of view of global environment protection, do not release CFCs into the atmosphere during installation work)

1. Connect the charging hose of manifold gauge to the service port of 3-way valve (pushing insect pin).
2. Fully open the handle Lo of manifold gauge and operate vacuum pump.  
(If the needle of the low-pressure gauge reaches the vacuum immediately, check 1 procedure again)
3. Perform vacuuming 15 minutes or more, and make sure low pressure gauge reaches to  $-0.1$  MPa ( $-76\text{cmHg}$ ).  
When the vacuuming completes, fully open the handle Lo of manifold gauge and stop the operation of vacuum pump, and leave it for 1 ~ 2 minutes. Then, remove the connection side of the charging hose of vacuum pump adaptor after checking the needle of manifold gauge does not turn back.
4. Open the stem of 2-way valve to  $90^\circ$  in anti-clock wise, and close the 2-way valve after 10 seconds, and perform gas leakage test.
5. Remove the charge hose from the service port of 3-way valve, and open the stems of 2-way and 3-way valves (open the valves to anti-clock wise carefully, do not use full strength to open)
6. Tighten the service port cap with torque wrench  $18\text{ N}\cdot\text{m}$  ( $1.8\text{ kgf}\cdot\text{m}$ )  
Tighten the caps of 2-way and 3-way valves with torque wrench  $18\text{ N}\cdot\text{m}$  ( $1.8\text{ kgf}\cdot\text{m}$ )
7. After the tightening of each cap, check gas leakage around the cap.

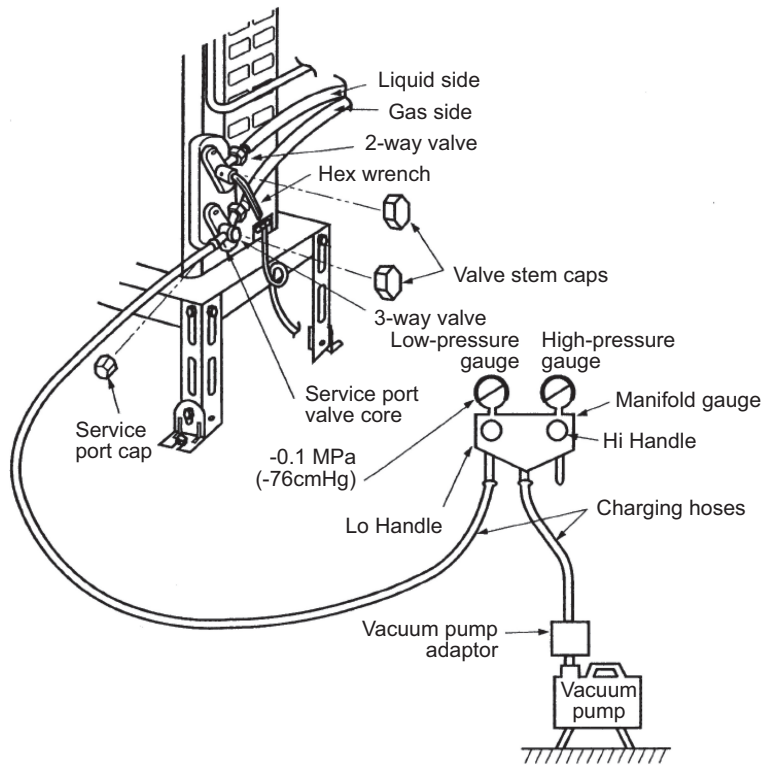

### 13.6.2 Process of refrigerant recovery

1. Connect the center charging hose of manifold gauge to the in-let side of recovery device.
2. Connect the valves of the discharge side of recovery device and liquid side of refrigerant cylinder with red hose (charging hose).
3. Connect the yellow float switch cable of the recovery device to the refrigerant cylinder.
4. Open the low pressure side valve of manifold gauge.
5. Slightly loosen the charging hose of in-let connecting side of recovery device and perform air purge.
6. Open the liquid valve of refrigerant cylinder and slightly loosen the charging hose in discharging side of recovery device, and perform air purge (the recovery cylinder needs slight inside pressure).
7. Insert electric plug of recovery device into electrical outlet (the fan operation starts).
8. Turn the valve 1 and 2 of recovery device to pressure equalization point.
9. After a few seconds, turn back the valve 1 and 2 to the original position.
10. Turn the switch of the recovery device to "ON". (the compressor operation starts)
11. When the low pressure of manifold gauge is close to "0", close the low pressure side valve, turn "OFF" the recovery device switch.
12. Remove the center charging hose of manifold gauge from the recovery device.

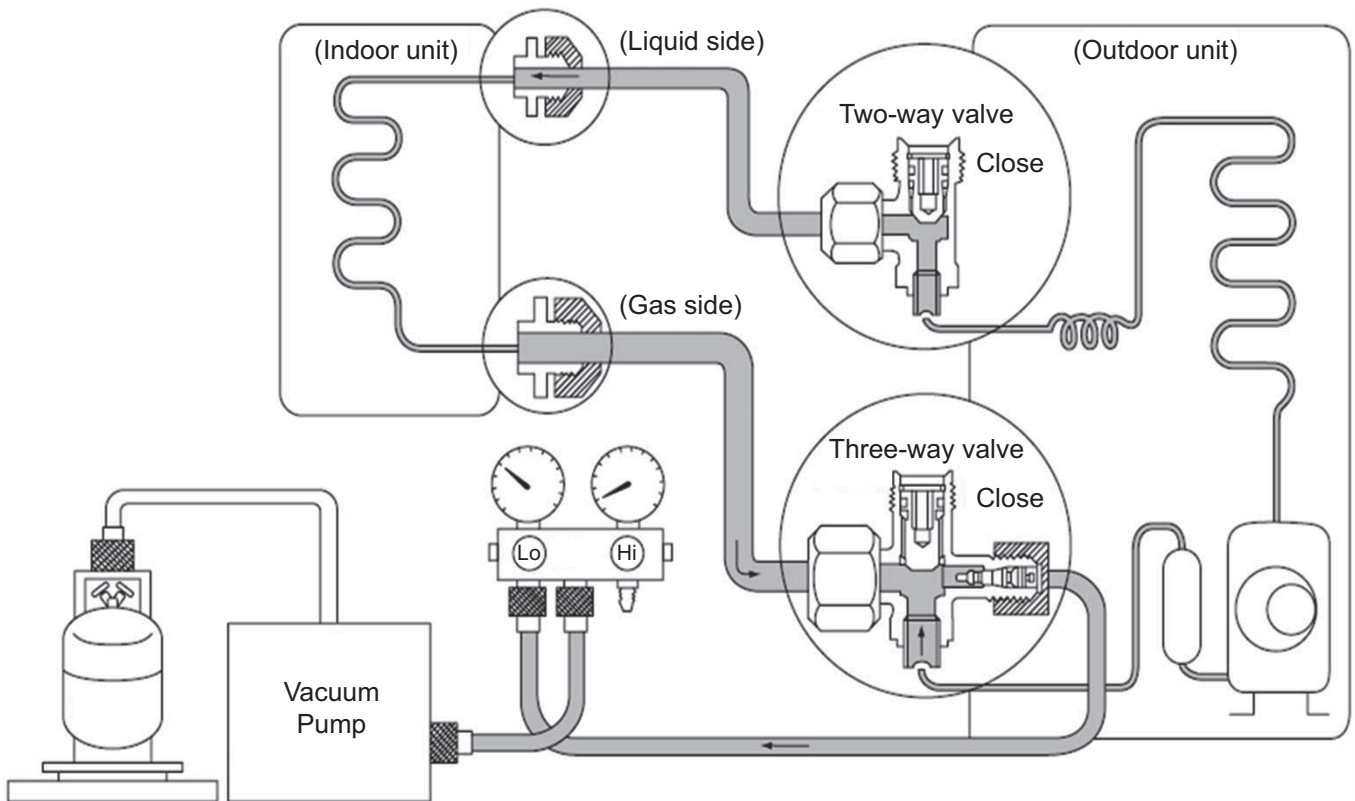

### 13.6.3 Relocation

#### 1. Removing the air conditioning unit

##### a) Recovery of outdoor unit refrigerant by pumping down

Press “forced cooling button” (as a general rule, since 1998 the name of cooling testing button is changed, and this name is unified within the air conditioning industry), and then you are able to start cooling operation in which the room temperature is low, and you can recover the refrigerant from the outdoor unit.

1. Check the valve stems of two-way and three-way valves are open by being turned to anti-clockwise (Remove the caps, and confirm the bars are fully open. Use hexagon wrench <4 mm> to open and close the valves).
2. Press the “Emergency Operation” button of the indoor units for five seconds and release [Forced cooling operation] (for old models, press “forced cooling” button). Then, operate the air conditioning unit for about 10 minutes.
3. Turn the stem of the two-way valve to the clock-wise and close the valve.
4. After about 2 ~ 3 minutes, turn the stem of the three-way valve quickly to the clock-wise, and stop the operation.

**Caution:** In the pump down operation, stop the compressor before removing the refrigerant pipes.

If you do not stop the compressor operation, and if the valve is open and remove the refrigerant pipes, the air may be sucked into the system and causes extreme high temperature in the refrigerant cycle. This may result in rupture or injury, etc.

5. Attach and tighten the caps of two-way and three-way valves with torque wrench.
6. Remove the connecting pipes (liquid side and gas side).

##### b) Removal of indoor and outdoor units

1. Remove the connecting pipes and wires between the indoor and outdoor units.
2. Attach capping flare nuts on the edges of the pipes, connecting the indoor and outdoor units, in order to prevent dust and moisture get into the pipes.
3. Remove the indoor and outdoor units.

#### 2. Unit installation

Use new refrigerant pipes for the installation, and perform air purging using vacuum pump and gas leakage testing stated in 14.5.1.

### 13.6.4 Replacement of air conditioning units and evacuation (when re-using the existing pipes)

When replacing the air conditioning units, you might use the existing pipes, but it is recommended to perform flaring again. In case of unit replacement, even if the unit is new refrigerant air conditioner, if the refrigerant oil is different, it may cause problem. Further, when re-using the existing refrigerant pipes, it is recommended to evacuate the pipes as much as possible, due to the reason that much refrigerant oil may be attached on the surface of the pipes. If the pipes are used without evacuation, the remaining refrigerant oil may cause under-performance and abnormal refrigerant cycle caused by non-compatibility of those oils.

### 13.6.5 Inter-changeability of refrigerant

Do not operate air conditioning units inserting wrong (or mixed) refrigerant (R22, R410A, R32). It may cause malfunction of the units, and at the same time, may cause serious incident such as rupture of the refrigerant cycle.



### 13.6.6 Re-insertion of refrigerant in service

When re-insertion is needed, follow the procedures to ensure the insertion of new refrigerant at correct amount.

1. Attach charging hose (blue) to the service port of the outdoor unit.
2. Attach charging hose (red) to the vacuum pump. Fully open the 2-way and 3-way valves.
3. Place the refrigerant cylinder on the digital scale for refrigerant charging and connect the charge hose (yellow) to the connection port of the vacuum pump and the digital scale. Leave the cylinder valve fully open.
4. Fully open the handles Lo and Hi of the manifold gauge, and switch on the vacuum pump, and then perform evacuation for at or more than one hour.
5. Confirm the compound gauge of  $-0.1\text{ MPa}$  ( $-76\text{cmHg}$ ) and fully open the handles of Lo and Hi, and switch off the vacuum pump. Leave it for about 1 ~ 2 minutes and confirm the needle of the compound gauge does not turn back.

Refer to the picture below to follow the procedures below.

6. Remove the charging hose (red) of the manifold gauge from the vacuum pump adaptor.
7. After adjusting the digital scale to zero, open the cylinder valve and the valve Lo of the manifold gauge, and insert the refrigerant.
8. If it is not possible to insert the refrigerant at regulated amount at once, operate the cooling mode and gradually insert the refrigerant (recommended amount approx.  $150\text{ g} / 1\text{ time}$ )  
\*Do not insert much refrigerant at once.
9. Close the open/close valve and insert the refrigerant in the charging hose to the outdoor unit.  
\*Perform this procedure during operating cooling operation. Close the stem of the two-way valve, and when the pressure of the manifold gauge becomes zero (0), quickly remove the charging hose (blue). Immediately open the 2-way valve, and stop the cooling operation.
10. Final checking ••• Confirm the 2-way and 3-way valves are fully open.  
Attach the caps of the service port and control valve, and then check the gas leakage around the caps.

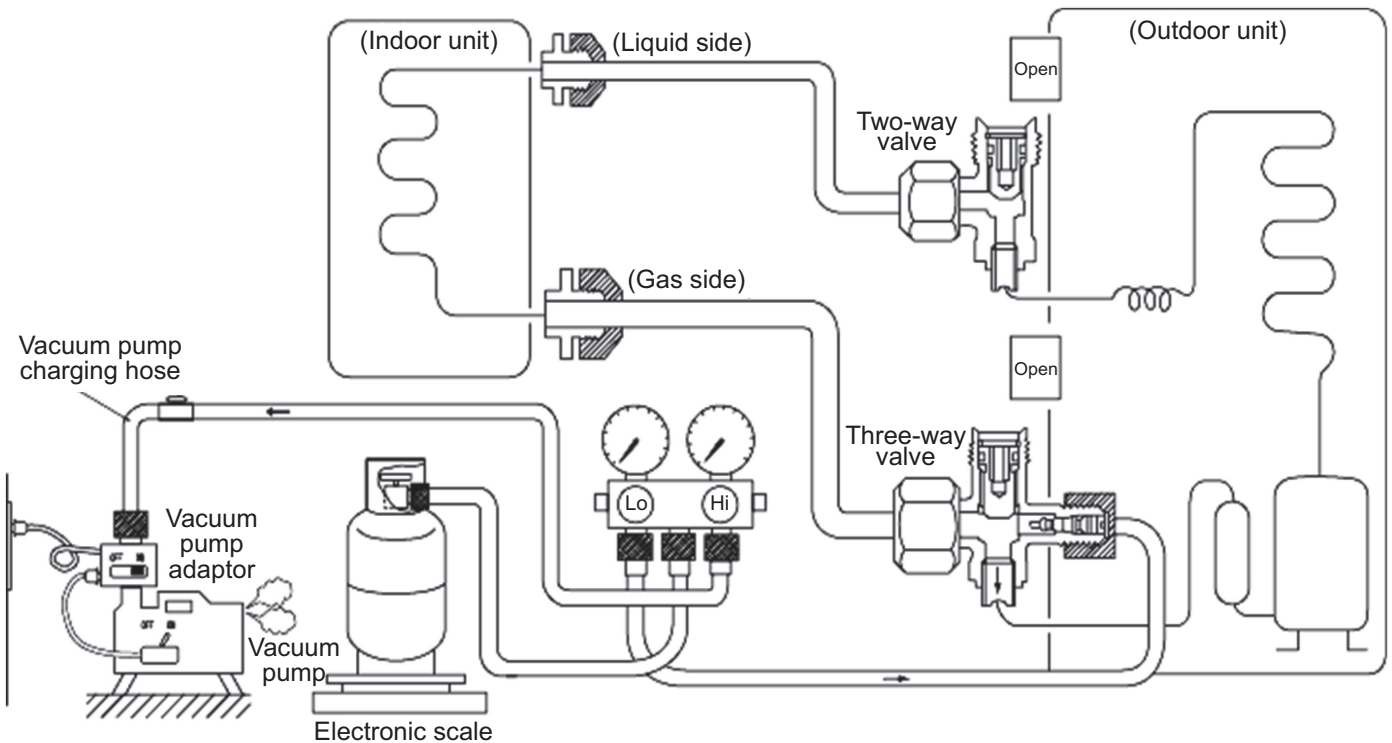

## 13.7 Repairing of refrigerant cycle / Brazing point

### 13.7.1 Preparation for repairing of refrigerant cycle / brazing

Brazing which is a technique needed for repairing refrigerant cycle requires advanced technique and experience, and this brazing procedure can only be performed by the workers who completed “Gas Welding Skill Training” regulated by the Occupational Safety and Health Act, and went through the training programs of refrigerant operations. Dismantling and re-connecting (assembling) refrigerant system requires working space, and the space has to ensure good air flow and fire prevention (water bucket and fire extinguisher). Moreover, the worker has to ensure the wearing of goggles, grabs, safety shoes, and long sleeve shirts, and be aware of work safety and attempt to prevent secondary defect (quality assurance of products). For brazing the indoor / outdoor unit structural components (heat exchangers, compressors, expansion valves, four-way valve blocks), after the recovery of all refrigerant, confirm that no refrigerant remains in the system, and fully open the 2-way and 3-way valves. When the brazing is conducted outside, check and make sure no refrigerant is contained in the air (be careful with vaporized refrigerant). Furthermore, protect the compressor terminal with metal plates, and heat but use wet clothes to cool down (releasing the heat) the expansion valves, and four way valves (prevent destruction of parts). In brazing, it is important to pour the brazing material without melting the base metal based on capillary action principle. In case of holes and oxidizing caused by overheating, do not perform re-brazing or alteration but replace the parts.

### 13.7.2 Adjustment of vacuum pump pressure

#### 1. Cylinder with adjustment handle

1. Check and confirm the adjustment handle of the 1<sup>st</sup> pressure adjuster is loosen (anticlockwise). If cylinder valve is opened when the 1<sup>st</sup> gauge pressure adjust handle is closed, the 2<sup>nd</sup> gauge might get broken.

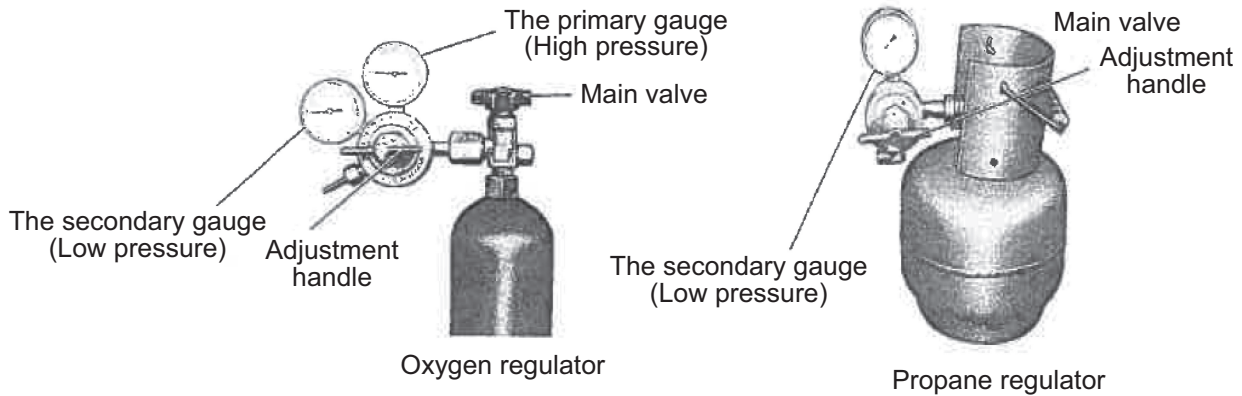

2. Open the cylinder valve, and check the remaining amount with the first side pressure gauge.
3. Check the pressure of 2<sup>nd</sup> gauge and turn the adjustment handle to clock-wise direction to adjust the pressure.
  - ◎ Oxygen 2<sup>nd</sup> side gauge pressure . . . . . 0.5 MPa (5.0 kgf / cm<sup>2</sup>)
  - ◎ Propane 2<sup>nd</sup> side gauge pressure . . . . . 0.05 MPa (0.5 kgf / cm<sup>2</sup>)

2. Cylinder without adjustment valve  
 2<sup>nd</sup> side gauge pressure is adjusted by the adjuster.  
 Check the both side valves of the torch and open the cylinder valve to check the remaining refrigerant in the cylinder.  
 Caution: Do not attach oil component on the connection port of the adjuster.  
 Especially, use an oxygen cylinder adjuster which is no oil substance type. Do not dismantle or repair the adjuster and pressure gauge.

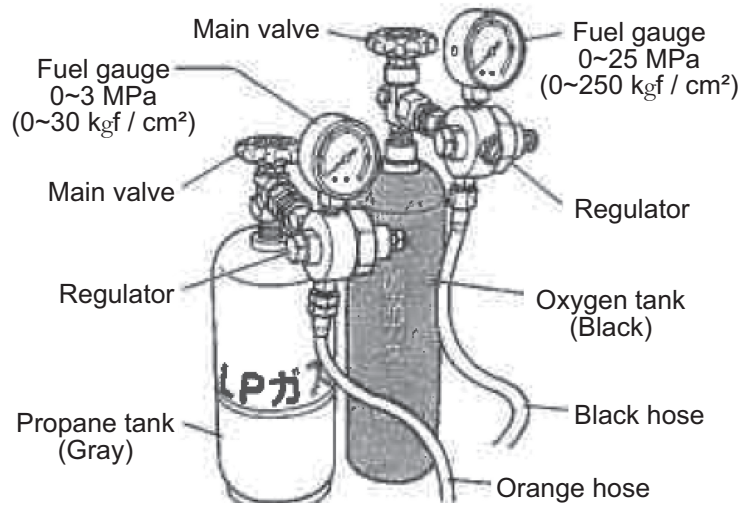

### 13.7.3 Checking of gas provision

Checking there is no fire around the torch, and then confirm the provision of gas.

1. Slightly open the “propane valve” of the torch, and make sure the gas comes out from the torch crater and then close the “propane valve”.
  2. Slightly open the “oxygen valve” of the torch and make sure the gas comes out from the torch crater and then close the “oxygen valve”.
- Check there is no gas leakage around the hose connection.

### 13.7.4 Adjustment of flame

1. Slightly open the “propane valve” of the torch and lit with spark lighter.  
 This moment, the flame is only by propane and the color is red.
2. Gradually open the “oxygen valve” of the torch to mix oxygen, and adjust the amount of propane and oxygen with the valve to make the flame suitable for brazing work.  
 If the white core flame splits into two, the torch crater might be clogged. In this case, remove the crater from the torch and check.

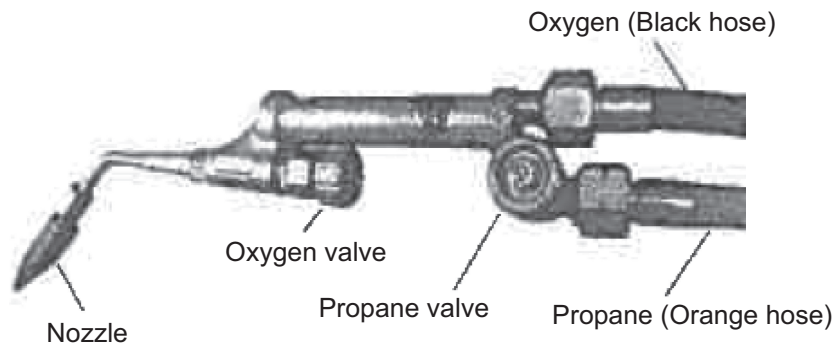

### 13.7.5 Types of flame

Types of flame change based on the proportion of propane and oxygen.

#### [Neutral Flame]

Perform brazing with this flame

(This is a flame when oxygen and propane are mixed at proper proportion, and has lesser effect on the brazed metals)

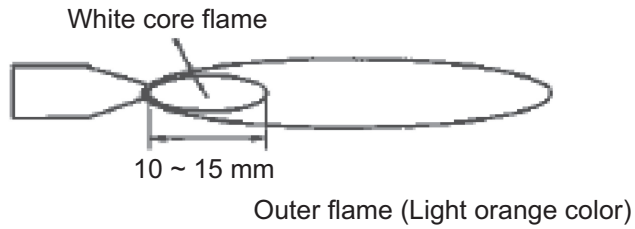

#### [Carbide Flame]

When propane is excessive, the flame has white color flame in between the white core flame and outer flame. (This is due to the lack of oxygen and the proportion of unburned propane is excessive.)

The black carbon created during the brazing work may contaminate the surface of the brazed metal).

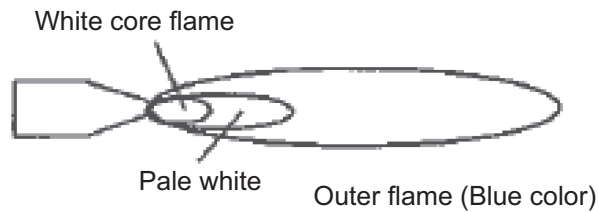

#### [Oxidizing Flame]

Oxygen is more compared to the neutral flame. Although the flame size is small, this has the highest flame heat. However, due to the excessive oxygen contained in the flame, the brazing point gets oxidized. (This flame may cause holes, due to the high heat. The pipe may get melt)

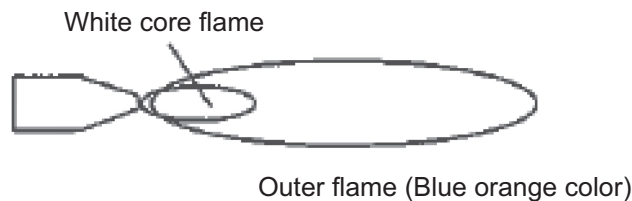

### 13.7.6 Closing the flame

#### [In case of short break]

1. Close the "propane valve" of the torch.
2. Close the "oxygen valve" of the torch.

#### [In case of finishing work]

1. As above, close the flame following the procedure of "In case of short break".
2. Completely close the valves of oxygen and propane cylinders.
3. Release the remaining gas inside the hose by opening the "oxygen valve" and "propane valve" of the torch. Confirm the 1<sup>st</sup> and 2<sup>nd</sup> side gauge pressures of "oxygen" and "propane" cylinder pressure adopter are "zero".

### 13.7.7 Selection of brazing material

Use BAg brazing material (silver solder) to increase the welding performance.

Category	JIS Standard Number	Composition of ingredients (%)						Temperature (°C)			Tensile strength (Reference)		Characteristics and applications
		Ag	Cu	Zu	Cd	Ni	P	Solidus	Liquidus	Brazing temp	Kgf/cm <sup>2</sup>	Base material	
BAg	BAg • 1A	49.0 ~ 51.0	14.5 ~ 16.5	14.5 ~ 18.5	17.0 ~ 19.0	—	—	approx. 625	approx. 635	635 ~ 760	45.5	S20C	Liquidity is good at low temperature, it is preferable to a small junction of the gap in the universal form.
	BAg • 1	44.0 ~ 56.0	14.0 ~ 16.0	14.0 ~ 18.0	23.0 ~ 25.0	—	—	approx. 605	approx. 620	620 ~ 760	45.5	S20C	It has similar performance to the BAg • 1A, and suitable for every base material except the light weight metal.
	BAg • 2	34.0 ~ 36.0	25.0 ~ 27.0	19.0 ~ 23.0	17.0 ~ 19.0	—	—	approx. 605	approx. 700	700 ~ 845	45.5	S20C	It is a brazing filler metal in universal form, suitable for a slightly larger gap junction.
	BAg • 3	48.0 ~ 51.0	14.5 ~ 16.5	13.5 ~ 17.5	15.0 ~ 17.0	2.5 ~ 3.5	—	approx. 630	approx. 690	690 ~ 815	35 ~ 70	SS ~ SUS	It has good corrosion resistance in stainless steel-based brazing, suitable for brazing tungsten carbide, aluminum bronze and copper.
BCuP	BCuP-2	—	remain	—	—	—	6.8 ~ 7.5	approx. 710	approx. 785	690 ~ 815	21 ~ 24.5	Cu	Good liquidity, suitable for brazing copper tube.
	BCuP-3	4.8 ~ 5.2	remain	—	—	—	5.8 ~ 6.7	approx. 645	approx. 815	720 ~ 815	21 ~ 24.5	Cu	Suitable for brazing when the joint spacing is not constant
	BCuP-5	14.5 ~ 15.5	remain	—	—	—	4.8 ~ 5.3	approx. 645	approx. 800	705 ~ 815	21 ~ 24.5	Cu	When brazing of copper and copper, it is used without a flux, but not possible for brazing basic materials

#### Caution

BCuP (phosphorus copper wax) is easy to react with sulfur, and makes a brittle compound water soluble, and causes gas leakage. In hot spring areas, use other brazing materials or paint the surface for protection.

### 13.7.8 Need of flux

**Use flux to protect the base materials.**

1. Remove impurity and oxide film on the metal base, and improve the flow of the brazing material.
2. Prevent oxidation of the metal surface in brazing.
3. Reduce the surface tension of the brazing material.

### 13.7.9 Need of nitrogen gas

In order to prevent oxidation in the pipe, perform the brazing operation in nitrogen gas flow. Flow rate 0.05 m<sup>3</sup> / h, or pressure reducing valve at 0.02 MPa (0.2kgf / cm<sup>2</sup>) below.

### 13.7.10 Checking of brazing (insert) points

1. No impurity on the brazing point  
If dirt or oil is attached on the brazing point, the brazing filler metal does not reach to junction, and it may cause poor welding.
2. Adequate gap space in the brazing point  
The advantage of capillary current situation is used in brazing. If the gap space is too large, this phenomenon may not occur and it may cause poor welding because brazing filler metal does not flow to join the front part.
3. Appropriate size for insertion  
The guideline for pipe insertion dimensions is to three times the diameter of the base material, but you need to decide the insertion size in consideration of the clogging of the brazing material. Generally, for thin pipes, you need to increase the insert size, and for thick pipe vice versa.
4. Brazing material to flow from top to bottom  
Brazing filler metal will easily flow to the connecting portion by capillary action. Further, by bending the brazing portion of [dryer side] of the capillary tube at 120°, you can prevent the damage of dryer inside and the clogging of brazing material caused by the excessive insertion of capillary tube.

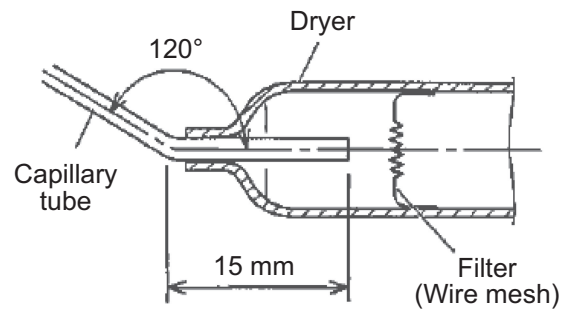
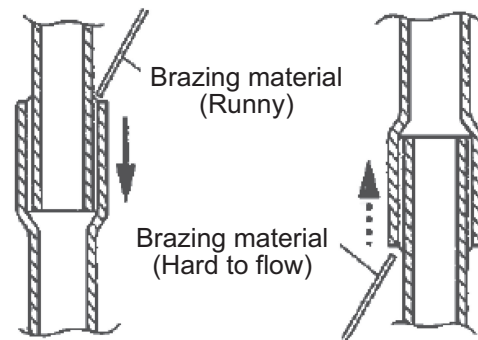
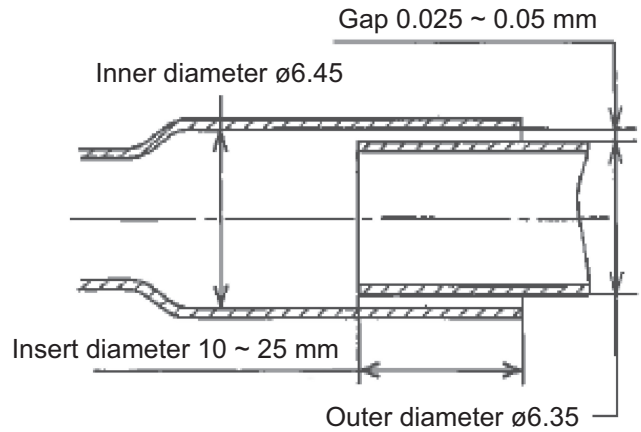

### 13.7.11 Brazing and heating

1. Place the flame to a pipe which has more heat capacity in order to let the brazing material melt by the pipe heat. Heat the pipe up to the melting temperature of the brazing material, but when it is overheating, assess the temperature by pipe color in order not to melt the pipe.

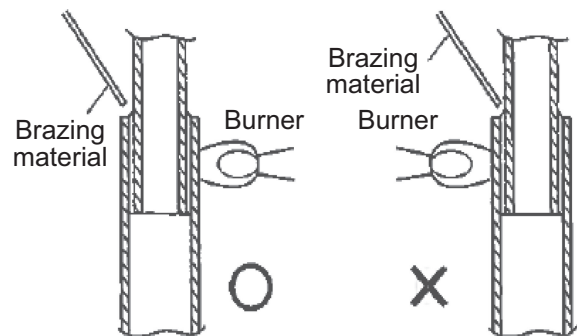

The pre-heating is to heat the base material until the melting temperature, and requires certain training to distinguish the color of the heated base material in order not to melt the material.

- The color and temperature of copper tube
- Becoming red color •••••••• 480°C
  - Dull red •••••••• 650°C
  - Cherish red •••••••• 760°C
  - Brightening cherish red •••••••• 870°C

(Reference)

Melting temperature of copper •••••••• Approx. 1083°C

Maximum temperature obtained in propane and oxygen •••••••• Approx. 1083°C

The important point is to heat the bonding part uniformly within a short period of time until reaching to the brazing temperature in the following manner.

2. Apply the flame on to the side with better heat transmission. If the pipe thickness is consistent, by heating like 30% iron and 70% copper, the copper pipe inside reaches to brazing temperature. Iron pipes have low heat transmission and only the part the flame is applied get high temperature, and this causes oxidization of the pipe. The flow of the brazing filler is affected negatively.
3. Apply the flame on to the side of larger heat capacity.  
When brazing a thin tubes such as capillary tube and dryer, etc., caution has to be taken to apply the flame to the dryer side (thick pipe side), in order to prevent burn out by the heat.
4. When brazing the compressor connection pipes (suction and discharge), remove the sound insulation plate and the fan, and place the compressor stand vertically (to prevent the leakage of compressor refrigerating machine oil), and apply the flame from the compressor body side.

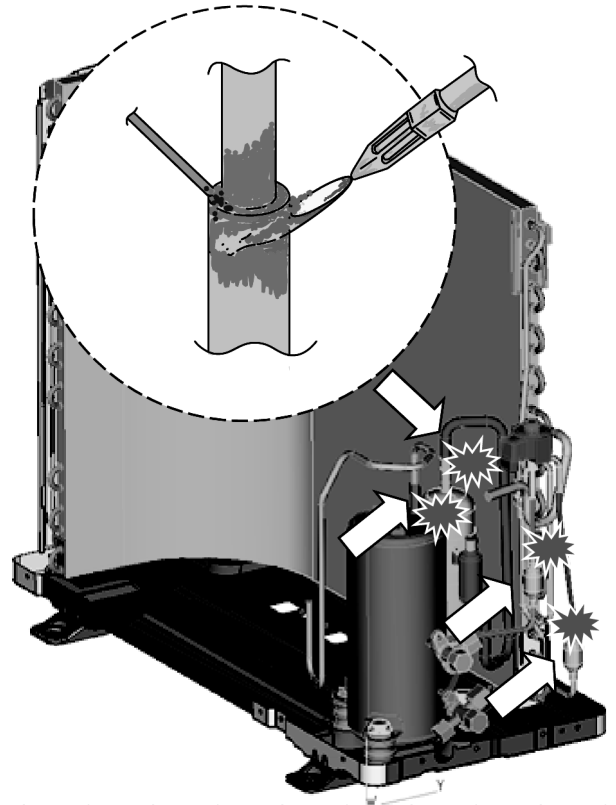

### 13.7.12 Terminologies of brazing

Pin holes → Small holes are generated on the surface of the brazing metal.

Wet temperature → Liquidus temperature at which the brazing material starts flowing out by heating, generally it is the liquidus-line temperature.

Blow holes → Hollows made by gas in the brazing material of brazing portion (gas reservoirs).

Pits → As a result of blow holes, small dents generated on the outside surface of welding.

Voids → The brazing material does not reach completely to the brazing part. It cannot be identified from outside.

## 13.8 <Reference> Analysis method for no error code, no cooling / no warming

### 13.8.1 Preparation for appropriate diagnosis

In order to obtain appropriate operation characteristics, minimum 15 minutes or more operation time [testing operation (rated operation)] is required.

#### 1. Method of rated operation (rated operation)

For the models which have two buttons of “emergency operation and forced cooling operation”, press forced cooling button once. For the models which have only emergency operation button, press the button once for 5 seconds and when hear “beep” sound, release the button. Then, cooling operation starts.

#### 2. Checking the mal-functions of indoor / outdoor units

- 1) Any obstacles against heat release and air suction? (short circuit)  
(Forget to remove the outdoor unit cover or fallen leaves blocking the outdoor unit)
- 2) Are the indoor unit air filters clean? (obstructing heat suction)
- 3) Is the setting temperature on the remote controller correct? (is the setting temperature set at lower/higher than the room temperature?)

### 13.8.2 Understanding and verification of refrigerant cycle

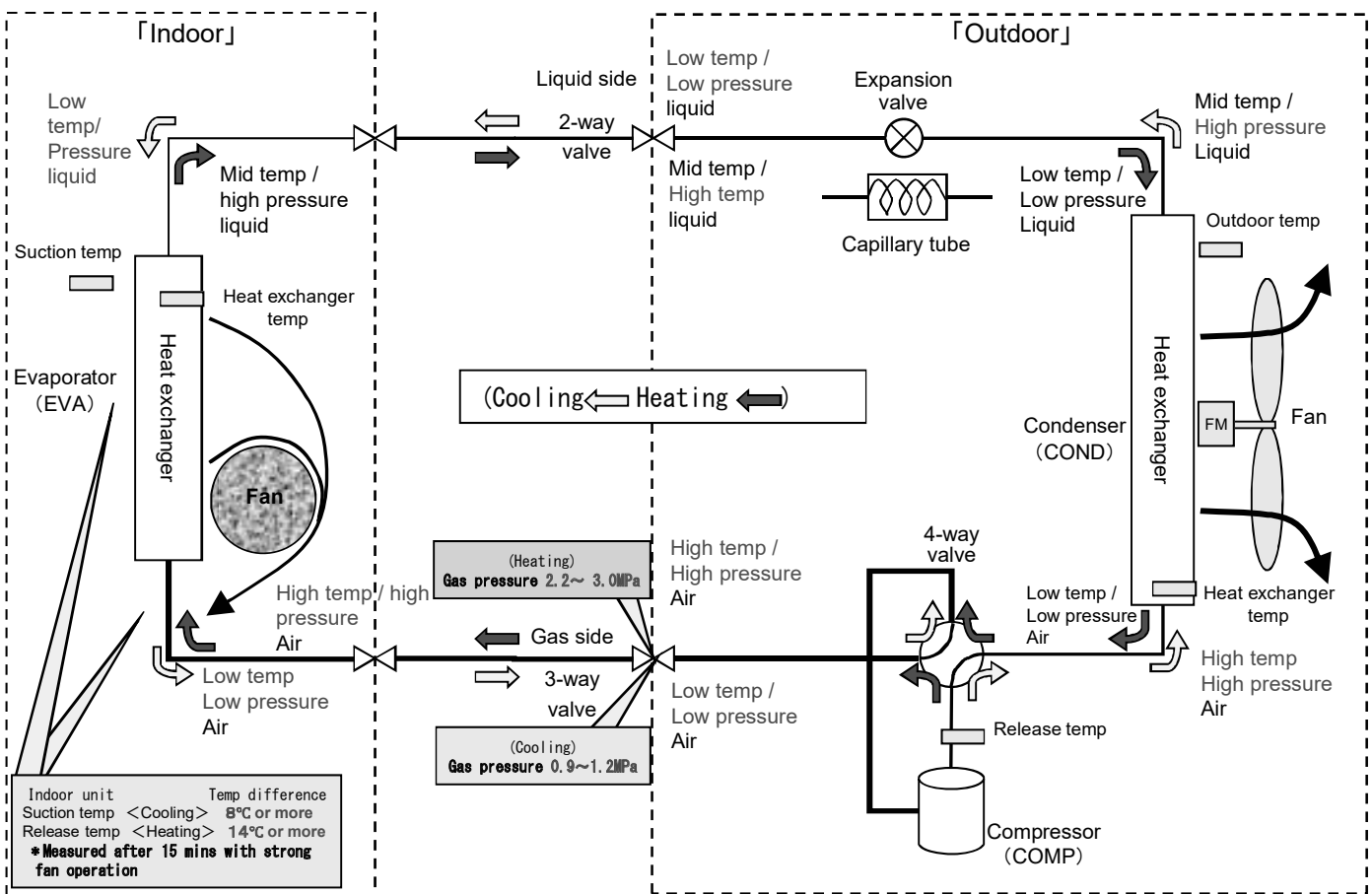



1. Measuring temperature
  - 1) Indoor unit suction temperature, release temperature, temperature difference, → Measure by thermometer
  - 2) 2-way valve pipe temperature in cooling mode is low temperature (benchmark : 5 ~ 10°C), in heating mode is medium temperature (benchmark : 25 ~ 35°C).
  - 3) 3-way valve pipe temperature in cooling mode is low temperature (benchmark : 7 ~ 15°C) in heating mode is high temperature (benchmark : 38 ~ 50°C).
2. Measuring electric current
  - Measuring electric current in operation → check by clamp meter (refer to table of technical characteristic guideline)
3. Measuring pressure
  - Measuring gas pressure → check the pressure by manifold gauge (refer to table of technical characteristic guideline)
4. Any sound from the expansion valve?  
(when starting the operation and the outdoor unit is turned on, the expansion valve is re-set, check if there is any edged sound or clack sound)

### 13.8.3 Guidance for diagnosis of refrigerant cycle

Comparison with normal operation	Cooling mode	
	High	Low
Refrigerant pressure	Excess insertion of refrigerant	Clogged capillary, expansion valve malfunction
	Heat releasing obstruction	Clog by moisture
	Dirty condenser, attachment of impurity	Lack of refrigerant gas
	Compressor malfunction	
Operation electric current	Excess insertion of refrigerant	Lack of refrigerant gas
	Heat releasing obstruction	Compressor malfunction
	Dirty condenser, impurity	Mixture of air
		(Insufficient evacuation)
2-way valve temperature	Excess insertion of refrigerant	Clogged capillary, expansion valve malfunction
	Compressor malfunction	Lack of refrigerant gas
3-way valve temperature	Lack of refrigerant gas • Compressor malfunction	Excess insertion of refrigerant
	Clogged capillary, expansion valve malfunction	

Suction temperature & Release air temperature	Temperature difference at or less than 8°C in cooling operation • • • Causes		
	• Heat releasing obstruction	• Dirty condenser	• Attachment of impurity
	• Lack of refrigerant gas	• Excess insertion of refrigerant	
	• Mixture of air	• Mixture of moisture	
	• Clogged capillary	• Expansion valve malfunction	• Compressor malfunction

◎ Above all are based on the condition that the installation work is properly performed (no issues in indoor / outdoor pipe connections, etc.)

# 14. Operation and Control

## 14.1 Basic Function

Inverter control, which equipped with a microcomputer in determining the most suitable operating mode as time passes, automatically adjusts output power for maximum comfort always. In order to achieve the suitable operating mode, the microcomputer maintains the set temperature by measuring the temperature of the environment and performing temperature shifting. The compressor at outdoor unit is operating following the frequency instructed by the microcomputer at indoor unit that judging the condition according to internal water setting temperature and water outlet temperature.

### 14.1.1 Internal Water Setting Temperature

Once the operation starts, control panel setting temperature will be taken as base value for temperature shifting processes. These shifting processes are depending on the Air-to-Water Heat pump settings and the operation environment. The final shifted value will be used as internal water setting temperature and it is updated continuously whenever the electrical power is supplied to the unit.

### 14.1.2 Heating Operation

#### 14.1.2.1 Thermostat Control

- Compressor is OFF when Water Outlet Temperature – Internal Water Setting Temperature  $> 2^{\circ}\text{C}$  for continuously 3 minutes.
- Compressor is ON after waiting for 3 minutes, if the Water Outlet Temperature – Water Inlet Temperature (temperature at thermostat OFF is triggered)  $< -3^{\circ}\text{C}$ .

#### 14.1.2.2 Thermostat Control (Outdoor Ambient Temperature)

Stops provide heating to room side during high outdoor ambient condition.

Control content:

- Heating operation and water pump will turn OFF when outdoor ambient temperature  $>$  outdoor thermo off temperature  $+ 3^{\circ}\text{C}$ .  
(Outdoor thermo off set temperature is set by control panel. Thermo off set temperature is between  $5^{\circ}\text{C} \sim 35^{\circ}\text{C}$ )
- Heating operation will resume when Outdoor ambient temperature  $<$  Outdoor thermo OFF set temperature  $+ 1^{\circ}\text{C}$ .

#### 14.1.2.3 Heat Mode Operation

Operation of heat pump provide heating capacity to room side by hot water through heating panel, floor heating or fan coil unit.

- 1 3 ways valve control:
  - 3 ways valve switch and fix to heating side.
- 2 Heat pump operates follow normal heating operation.
- 3 Back up heater operate follow normal operation.
- 4 2 ways valve control:
  - 2 ways valve opens.

### 14.1.3 Cooling Operation

#### 14.1.3.1 Thermostat control

- Compressor is OFF when Water Outlet Temperature – Internal Water Setting Temperature  $> -1.5^{\circ}\text{C}$  for continuously 3 minutes.
- Compressor is ON after waiting for 3 minutes, if the Water Outlet Temperature – Water Inlet Temperature (temperature at thermostat OFF is triggered)  $> 3^{\circ}\text{C}$ .

#### 14.1.3.2 Cool Mode Operation

- 1 3 ways valve control:
  - 3 ways valve switch and fix to cooling side.
- 2 Heat pump operates follow normal cooling operation.
- 3 Room heater DOES NOT operate during cool mode.
- 4 2 ways valve control:
  - 2 ways valve is closed.

## 14.1.4 Target Water Temperature Setting

### 14.1.4.1 Target Water Temperature Control of Standard System (Optional PCB not connected)

There are 2 types of temperature control selection which are Compensation and Direct.

- Temperature control type selection by installer:
  - 1 Compensation : WLo, WHi, ODLo, ODHi can be set at installer menu.
  - 2 Direct : Direct Water Temperature Set
- Remote control setting by user:
  - 1 Compensation : Shift value  $\pm 5^{\circ}\text{C}$  from the compensation curve
  - 2 Direct : Direct water temperature set change

\*This setting only able to set when room sensor select as Water Temperature.

\*Instead of water temperature, user will set target room temperature when room sensor select as Room Thermistor OR Internal Room Thermostat.

- Target water temperature is calculated as below condition.
  - Target water temperature = A (Base temperature) + B (shift temperature)

A (Base Temperature)	Compensation	Direct
	Value from the curve + User shift value set	Direct value from user setting

- B (shift temperature) value is depend on the room sensor selection at remote controller as below table:

B (Shift Temp.)	B shift value depend on the room sensor selection at remocon as table below
Sensor selection	
Water temperature	B = 0
External Room thermostat	B = 0
Internal Room thermostat & Room Thermistor	<b>Cool Mode:</b> B = 0 ; when Zone OFF or Zone Room Thermo OFF B = B = 1* (room set temp (R/C) - actual room temp) Max/Min Regulation of B: (Max = 5 ; Min = -5)
	<b>Heat Mode:</b> B = 0 ; when Zone OFF or Zone Room Thermo OFF B = follow Heating Room Temperature PI control logic

- Maximum/minimum regulation of Target Water Temperature.

	Heating	Cooling
Max	55°C / 60°C*	20°C
Min	20°C	5°C

Between outdoor ambient  $-10^{\circ}\text{C}$  and  $-15^{\circ}\text{C}$ , the water outlet temperature gradually decreases from  $60^{\circ}\text{C}$  to  $55^{\circ}\text{C}$ .

#### Compensation Type: (Operation under Heat Mode and Cool Mode)

- The set temperature defines the parameters for the ambient (Outdoor temperature) dependent operation of the unit. The water temperature is determined automatically depending on the outdoor temperature. Default setting is the colder outdoor temperature will result in warmer water and vice versa. The user has the possibility to shift up and shift down the target water by remote control setting.

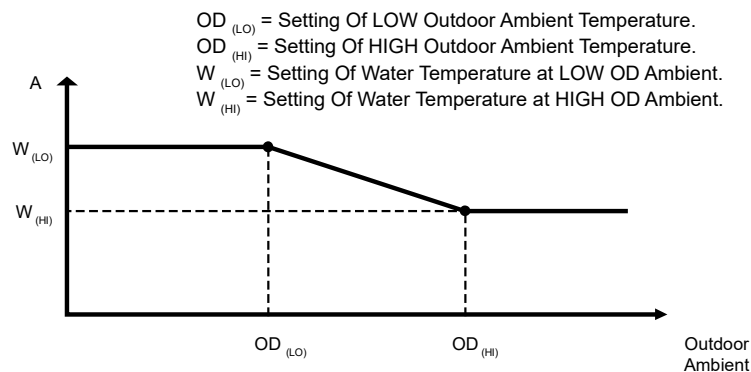

- Outdoor ambient is updated every 30 minutes when operation ON.
- Setting water outlet temperature always follow  $W_{(LO)}$  or  $W_{(HI)}$  whenever is higher if outdoor ambient sensor or indoor communication error happen.

However, when powerful mode is requested by remote control during heating mode, the higher value of HLo or Whi will be used for A calculation.

\* There are 2 compensation curves (for heating and cooling). During heating mode, the heating curve is used and during cooling mode, the cooling curve is use.

- Compensation curve set shift value:

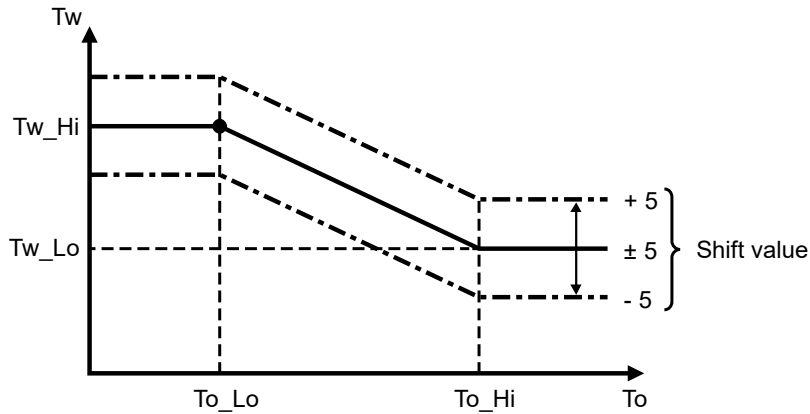

#### 14.1.5 Target Water Temperature at Extension System (Optional PCB is connected)

Target water temperature is calculated as below.

- Heat Mode:
  - Target water temperature setting:
  - Max= 55°C / 60°      Min= 20°C

Between outdoor ambient  $-10^{\circ}\text{C}$  and  $-15^{\circ}\text{C}$ , the water outlet temperature gradually decreases from  $60^{\circ}\text{C}$  to  $55^{\circ}\text{C}$ .

- When buffer tank selection is "YES:"
  - Target water temperature = Target buffer tank temperature +  $[2^{\circ}\text{C}]$
- When buffer tank selection is "NO"
  - If both zone 1 and zone 2 is active
    - Target Water Temperature = Higher zone target water temperature of Zone 1 and Zone 2.
  - If only one zone is active
    - Target Water Temperature = Zone target water temperature of active zone.
- Cool mode:
  - Target water temperature setting:
    - Max = 20°C      Min= 5°C
- When buffer tank selection is "YES"
  - If both zone 1 and zone 2 active
    - Target Water Temperature = Lower Zone Target Water Temperature of Zone 1 and Zone 2
  - If only one zone is active
    - Target Water Temperature = Zone Target Water Temperature of active zone
- When buffer tank selection is "NO"
  - If both zone 1 and zone 2 active
    - Target Water Temperature = Lower Zone Target Water Temperature of Zone 1 and Zone 2
  - If only one zone is active
    - Target Water Temperature = Zone Target Water Temperature of active zone

\*Cool Mode does not have SG ready control

### 14.1.6 Target Zone Water Temperature Control

Purpose:- To control zone mixing and zone pump according to the zone sensor temperature

#### 14.1.6.1 Target Zone 1 water temperature setting control

- Start condition
  - Heating zone 1 is ON by remote control or Timer or Auto Mode **OR**
  - Cooling zone 1 is ON by remote control or Timer or Auto Mode.
- Cancel condition
  - Heating zone 1 is OFF by remote control or Timer or Auto mode **AND**
  - Cooling zone 1 is OFF by remote control or Timer or Auto mode.
- Target Zone 1 water temperature is calculated as below condition.
  - Target Zone 1 water temperature = A (Base temperature) + B (shift temperature)

A (Base Temperature)	Compensation	Direct
	Value from the curve + User shift value set	Direct value from user setting

\* During heat mode and compensation select, if powerful mode is activated, higher value of WLo or WHi will be use as curve value.

- B (shift temperature) value is depend on the room sensor selection at remote controller as below table:

B (Shift Temp.)	B shift value depend on the room sensor selection at remocon as table below
Sensor selection	
Water temperature	B = 0
External Room thermostat	B = 0
Internal Room thermostat & Room Thermistor	<b>Cool Mode:</b> B = 0 ; when Zone OFF or Zone Room Therma OFF B = B = 1* (room set temp (R/C) - actual room temp) Max/Min Regulation of B: (Max = 5 ; Min = -5)
	<b>Heat Mode:</b> B = 0 ; when Zone OFF or Zone Room Thermo OFF B = follow Heating Room Temperature PI control logic
Pool Function Selected	B = Delta value setting from remocon

\* B = 0 regardless of which sensor selection, if SHP control bit is enable except Pool function select (maintain Pool "B" value)

\*\* Pool function also can be select at Zone 1 when optional PCB is connected and Zone 1 system is select.

- Maximum/minimum regulation of Target Water Temperature.

	Heating	Cooling
Max	55°C / 60°C*	20°C
Min	20°C	5°C

Between outdoor ambient -10°C and -15°C, the water outlet temperature gradually decreases from 60°C to 55°C.

- Target Zone 1 Water Temperature (Heat mode) during SG ready control
  - If buffer tank selection is "NO" then following shift is carried out.
    - While digital input is "10" or "11" then,  
Final Target Zone 1 water temperature  
= Target Zone 1 water temperature\* (SG ready % setting (remote control menu))%
  - If buffer tank selection is "YES"
    - No shift of Target Zone 1 Water Temperature. Target Buffer Tank Temperature will change accordingly.  
\* Refer to "Buffer tank temperature control"
- Target Zone 1 Water Temperature (Cool mode) during SG ready control
  - Final Target Zone 1 water temperature = Target Zone 1 water temperature + SG Cool Setting

### 14.1.6.2 Target Zone 2 water temperature setting control

- Start condition
  - Heating zone 2 is ON by remote control or Timer or Auto Mode **OR**
  - Cooling zone 2 is ON by remote control or Timer or Auto Mode.
- Cancel condition
  - Heating zone 2 is OFF by remote control or Timer or Auto mode **AND**
  - Cooling zone 2 is OFF by remote control or Timer or Auto mode.
- Target Zone 2 water temperature is calculated as below condition.
  - Target Zone 2 water temperature = A (Base temperature) + B (shift temperature)

A (Base Temperature)	Compensation	Direct
	Value from the curve + User shift value set	Direct value from user setting

\* During heat mode and compensation select, if powerful mode is activated, higher value of WLo or WHi will be use as curve value.

- B (shift temperature) value is depend on the room sensor selection at remote controller as below table:

B (Shift Temp.)	B shift value depend on the room sensor selection at remocon as table below
Sensor selection	
Water temperature	B = 0
External Room thermostat	B = 0
Internal Room thermostat & Room thermistor	<b>Cool Mode:</b> B = 0 ; when Zone OFF or Zone Room Thermo OFF B = B = 1* (room set temp (R/C) - actual room temp) Max/Min Regulation of B: (Max = 5 ; Min = -5)
	<b>Heat Mode:</b> B = 0 ; when Zone OFF or Zone Room Thermo OFF B = follow Heating Room Temperature PI control logic
Pool Function Selected	B = Delta value setting from remocon

\* B = 0 regardless of which sensor selection, if SHP control bit is enable except Pool function select (maintain Pool "B" value)

\*\* Pool function also can be select at Zone 2 when optional PCB is connected and Zone 2 system is select.

- Maximum/minimum regulation of Target Water Temperature.

	Heating	Cooling
Max	55°C / 60°C*	20°C
Min	20°C	5°C

Between outdoor ambient -10°C and -15°C, the water outlet temperature gradually decreases from 60°C to 55°C.

- Target Zone 2 Water Temperature (Heat mode) during SG ready control
  - If buffer tank selection is "NO" then following shift is carried out.
    - While digital input is "10" or "11" then,  
Final Target Zone 2 water temperature  
= Target Zone 1 water temperature\* (SG ready % setting (remote control menu))%
  - If buffer tank selection is "YES"
    - No shift of Target Zone 2 Water Temperature. Target Buffer Tank Temperature will change accordingly.  
\* Refer to "Buffer tank temperature control"
- Target Zone 2 Water Temperature (Cool mode) during SG ready control
  - Final Target Zone 2 water temperature = Target Zone 2 water temperature + SG Cool Setting

### 14.1.6.3 Zone Temperature Control Contents

- During Standard System (Optional PCB not connected)
  - Only 1 zone temperature control is available
  - This zone room temperature is control by either one of the 4 room sensor (Room Th, Int/Ext Room Thermostat, Water temperature)
  - Target Zone Water Temperature is calculated based on selected temperature control type (Compensation or Direct) and selected room sensor. Target Water Temperature will set same as Target Zone Water Temperature
  - Target Water Temperature is the temperature for heat pump to operate refer to indoor water outlet sensor.
  - Heat pump and water pump OFF when ROOM Thermo OFF (Zone thermo OFF by Room Th or Room Thermostat).
- \* There will be no zone sensor connected to zone 1 (No zone sensor error), mixing valve and zone pump will not operate.
- During Extension System (Optional PCB connected)
- Buffer Tank connection select "NO" &
  - One zone system is select
    - This zone room temperature control by either one of the 4 room sensor (Room Th, Int/Ext Room Thermostat, Water temp.)
    - Target Zone Water Temperature calculate base on selected temperature control type (Compensation or Direct) and selected room sensor.
    - Target Water Temperature will set same as Target Zone Water Temperature
    - Target Water Temperature is a temperature for heat pump to operate refer to indoor water outlet sensor.
    - Heat pump and water pump OFF when ROOM Thermo OFF (Zone thermo OFF by Room Th or Room Thermostat).
- \* There will be no zone sensor connected to zone 1 (No zone sensor error), mixing valve and zone pump will not operate.
  - 2 zone system select
    - Each zone room temperature is control by each sensor which select from either one of the 4 room sensor
    - Target Zone 1 & 2 Water Temperature is calculated based on selected temperature control type (Compensation or Direct) and selected room sensor.
      - \* Zone Mixing Valve & Zone pump will operate to achieve Target Zone Water Temperature which refer to zone sensor.
      - \* Zone Sensor will detect if zone sensor is open or short.
    - Target Water Temperature will set same as the active & higher zone water temperature setting. (When cooling mode, lower zone water temp setting)
    - Target Water Temperature is the temperature for heat pump to operate refer to indoor water outlet sensor.
    - Heat pump and water pump OFF when ROOM Thermo OFF (Both Zone thermo OFF by Room Th or Room Thermostat).
- Buffer Tank Connection select "YES" &
  - 1 zone system or 2 zone system select
    - Each zone control by each sensor which select from either one of the 4 room sensor
    - Target Zone 1 & 2 Water Temperature calculate base on selected temperature control type (Compensation or Direct) and selected room sensor. Each zone have their own Target Zone Water Temperature.
      - \* Zone Mixing Valve & Zone pump will operate to achieve each Target Zone Water Temperature which refer to zone sensor
      - \* Zone Sensor will detect if zone sensor is open or short.
    - Target Buffer Tank Temperature will be set as active & higher zone water temperature setting + Buffer Delta T. (Heating) Target Buffer Tank Temperature will be set as active & lower zone water temperature setting (Cooling).
    - Target Water Temperature will set as Target Buffer Tank Temperature + [2°C] (Heating) Target Water Temperature will set as Lower or Active Target Zone Water Temp. + [-3°C] (Cooling)
    - Target Water Temperature is a temperature for heat pump to operate refer to indoor water outlet sensor.
    - Heat pump and water pump OFF when ROOM thermo OFF
      - Heat mode: ROOM thermo OFF (Buffer Tank Temperature > Target Buffer Tank + [0°C])
      - Cool mode: ROOM Thermo OFF (Both Zone thermo OFF by Room Th or Room Thermostat)

### 14.1.7 Auto Mode Operation

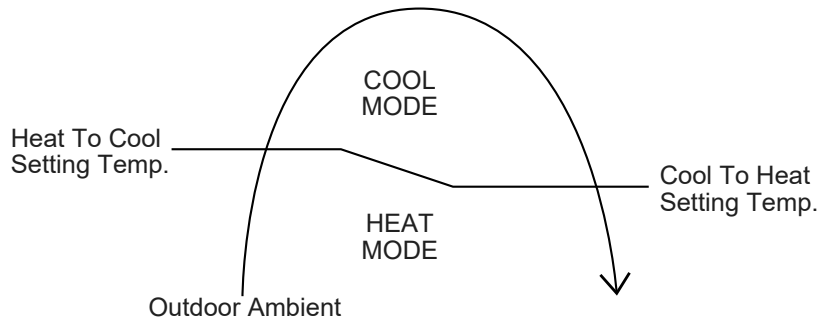

- Control details:
  - To enable the unit to operate either heat or cool mode automatically, heat to cool set temperature and cool to heat set temperature can be set by control panel.
  - Automatic operation is judged based on control panel setting temperature and outdoor ambient temperature.
  - \* Minimum setting of heat to cool set temperature is 1°C higher than cool to heat set temperature.
- Judgement control:
  - If outdoor ambient temperature < Heat to Cool Set Temperature, unit will operate in Heat Mode or else the unit will operate in Cool Mode.
  - If current operation is Cool mode, outdoor ambient temperature > Cool to Heat Temperature, unit will maintain Cool mode operation or else the unit will operate Heat mode.
  - If current operation is Heat mode, outdoor ambient temperature > Heat to Cool Temperature, unit will maintain Heat mode operation or else the unit will operate Cool mode.
  - Every 60 minutes the outdoor ambient temperature is judged.
  - When Auto + Tank mode is selected, operation mode switching is judged by both outdoor ambient temperature and indoor air temperature.

### 14.1.8 Auto Cooling Mode Operation Limit

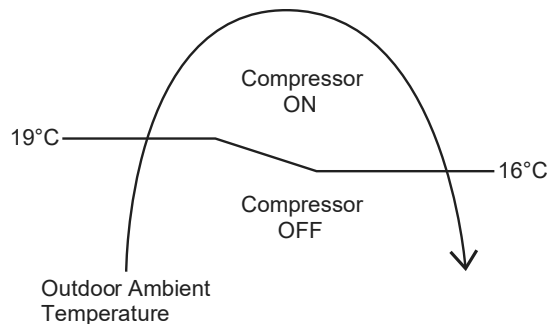

- Auto Mode Cooling Only operation will start once the outdoor ambient temperature reaches 10°C and compressor will continue to run until the outdoor ambient temperature drops to 8°C.
- Due to this limitation, If Heat to Cool temperature is set lower than 10°C, the compressor will not operate until the outdoor ambient temperature reaches 10°C or higher.

### 14.1.9 Tank Mode Operation

- 3 ways valve direction
  - 3 ways valve switch to tank side during Tank Thermo ON condition. Switch 3 ways valve to room side when tank achieve Tank Thermo OFF temperature.
- Tank Thermo ON/OFF Characteristic
  - Tank Thermo OFF

Case 1: Internal Tank Heater is select and Tank Heater ON

- Tank temperature > Tank Set Temperature continuously for 15 seconds. **OR**
- Water outlet >75°C



- Case 2: Tank Heater OFF OR External Heater is select
  - When heat pump OFF due to water thermos & Tank temperature > Tank water set temperature for continuously 20 seconds. **OR**
  - Tank temperature > Tank set temperature + 1°C for continuously 20 seconds.

Tank Thermo ON

Case 1: Tank Heater ON (Internal Tank Heater)

- Tank temperature < Tank set temperature + R/C (Tank re-heat temperature)

Case 2: Tank Heater OFF (Internal Tank Heater)

- Tank temperature < Tank water set temperature + R/C (Tank re-heat temperature)

\* When tank thermo ON, water pump will ON for 3 minutes then only heat pump turn ON.

\* Tank water set temperature = tank set temperature or 52°C whichever lower.

- 2 ways valve close
- Heat pump Thermostat Characteristic
  - Heat pump Water Outlet set temperature is set to below table:

Outdoor ambient temperature	Heat pump water outlet temperature
< -10°C	56°C
> -10°C	59°C

Characteristic of heat pump thermos ON/OFF under tank mode condition:

Water Outlet Thermo Condition

- Heat pump thermos OFF temperature:
  - 1 Heat pump thermo OFF temperature = Target Water outlet temperature + (1°C)
  - 2 Water outlet temperature > heat pump thermo OFF temperature for continuously 3 minutes, heat pump OFF but water pump continue ON.
- Heat pump thermo ON temperature:
  - 1 Heat pump thermo ON temperature = water inlet during thermo OFF time + [-3°C]
  - 2 When water outlet temperature < heat pump thermo ON temperature, heat pump ON.

Water inlet thermo protection condition

- Heat pump thermo OFF temperature:
  - 1 Water inlet temperature > [60°C/55°C] for continuously 30 seconds, heat pump OFF, water pump continue ON.
- Heat pump thermo ON temperature:
  - 1 Heat pump thermos ON temp = water inlet temperature < [60°C/55°C].

Outdoor ambient temperature	Water inlet temperature
< -10°C	55°C
> -10°C	60°C

Thermo ON/OFF for Heat Pump in Tank Operation:

When tank temperature achieve heat pump OFF condition, refer below condition:

Condition 1: Tank Heater ON (Internal Tank Heater)

- Heat pump will turn OFF, water pump continue ON and room heater will continue ON if tank temperature below tank heater thermo ON condition. 3 ways valve will only switch to room side after tank temperature reach tank heater thermo OFF condition.

Condition 2: Tank Heater OFF (Internal Tank Heater)

- If tank temperature achieve tank thermo OFF, heat pump turn OFF, water pump turn OFF, room heater OFF and 3 ways valve switch to room side.

When tank temperature achieve heat pump ON condition, water pump ON, heat pump ON and room heater turn OFF.

#### Heat pump OFF condition at Tank Mode

- Tank temperature > tank water set temperature continuously for 20 seconds after heat pump thermo OFF due to water thermo. (Heat pump turn OFF but water pump continue ON and room heater turn ON to achieve tank set temperature) **OR**
- Tank temperature > tank set temperature + [1°C] for continuously 20 seconds. (Heat pump OFF, water pump OFF, room heater OFF and 3 ways valve switch to room side)

#### Heat pump ON condition at Tank Mode

- Tank temperature < tank water set temperature + R/C setting (Tank re-heat temp) (Water pump turn ON OR continue ON, heat pump ON and 3 ways valve switch to tank side or maintain at tank side)

#### Tank heater control

- Internal heater only operates to tank side if Tank heater ON and backup heater is enable.

#### Internal heater turn ON condition:

- Tank temperature < tank set temperature **AND**
- Heat pump thermo OFF **AND**
- 20 minutes from previous heater off **AND**
- Internal tank heater selects USE from control panel.

#### Internal heater turn OFF condition:

- Tank temperature > tank set temperature for continuously 15 seconds **OR**
- Heat pump thermo ON **OR**
- Mode change or operation is off by control panel.

### 14.1.10 Heat + Tank Mode Operation

#### 1 3 ways valve control:

- 3 ways valve switch to room side during room heat-up interval and switch to tank side during tank heat-up interval. Both modes will switch alternately. Tank mode is the initial running mode of Heat + Tank mode.

#### 2 Heat pump operation control:

- During room heat-up interval
  - Follow normal heating operation.  
Switching to tank side depends to below cases:  
Case 1:  
[Previous switch from tank interval to room interval due to thermo OFF]
  - Switch to tank heat-up interval when Tank temp < Tank thermo ON temp (Room heat-up interval ends)  
Case 2:  
[If heating operation at room side is less than 30 minutes and switch to tank side 3 times consecutively]
  - Maintain at room heat-up interval regardless of the tank temperature. Switch to tank heat-up interval only when (Room Interval Timer is complete **OR** Room heat pump thermo OFF) **AND** Tank temperature < Tank thermo ON temperature.  
Case 3:  
[Previous switch from tank interval to room interval due to tank interval timer is complete]
  - Maintain at room heat-up interval regardless of the tank temperature. Switch to tank heat-up interval only when (Room Interval Timer is complete **OR** Room heat pump thermo OFF) **AND** tank temperature < Tank thermo ON temperature.
- During Tank heat-up interval
  - Tank interval is the first mode running when heat + tank mode is select.
  - Switch to room interval only when tank achieve tank thermo OFF **OR** tank heat-up interval timer is complete.
  - Heat pump operates according to normal tank mode operation.

#### 3 Room heater control:

- During heating heat-up interval
  - Follow normal room heater control operation.

- 4 Tank heater control:
  - During heating heat-up interval
    - Internal tank heater will not function under heating heat-up interval.
  - During tank heat-up interval
    - Internal tank heater will turn ON after heat pump thermo off to boil tank temperature to tank set temperature.
  - 2 ways valve control is open
  - Indoor water pump control:
    - Indoor water pump always turn ON if room heat pump thermo ON **OR** Tank thermo ON.

#### 14.1.11 Cool + Tank Mode Operation

- 1 3 ways valve control:
  - 3 ways valve switch to room side during room cooling interval and switch to tank side during tank heat-up interval. Both mode will switch alternately. Tank mode is the initial mode of cool + tank mode.
- 2 Heat pump operation control:
  - During room heat-up interval
    - Follow normal cooling operation.  
Switching to tank side depends to below cases:  
Case 1:  
[Previous switch from tank interval to room interval due to thermo OFF]
    - Switch to tank heat-up interval when Tank temperature < Tank Thermo ON temperature (Room interval will ends)  
Case 2:  
[If cooling operation at room side is less than 30 minutes and switch to tank side for 3 times consecutively]
    - Maintain at room cooling interval regardless of the tank temperature. Switch to tank heat-up interval only when (Room Interval Timer is complete **OR** Room heat pump thermo OFF) **AND** Tank temperature < Tank thermo ON temperature.  
Case 3:  
[Previous switch from tank interval to room interval is due to tank interval timer is complete]
    - Maintain at room cooling interval regardless of the tank temperature. Switch to tank heat-up interval only when (Room Interval Timer is complete **OR** Room heat pump thermo OFF) **AND** tank temperature < Tank thermo ON temperature.

\*Tank Thermo ON temperature:

Internal Tank Heater select USE	<Tank set temperature + R/C setting (Tank re-heat temperature)
Others	<Tank water set temperature + R/C setting (Tank re-heat temperature)

- During tank heat-up interval
  - Tank interval is the first mode running when the cool + tank mode is select.
  - Switch to room interval only when tank achieve tank thermo OFF **OR** tank heat-up interval timer is complete.
  - Heat pump operates according to normal tank mode operation.
- 3 Room heater control:
  - During room cooling interval
    - Room heater is OFF and not operates.
- 4 Tank heater control:
  - During room cooling interval
    - Internal tank heater will not function under room cooling interval.
  - During tank heat-up interval
    - Internal tank heater will turn ON after heat pump thermos off to boil tank temperature to tank set temperature.
- 5 2 ways vale is close.
- 6 Indoor water pump control:
  - Indoor water pump always turn ON if room heat pump thermo ON **OR** Tank thermo ON.

### 14.1.12 Outdoor Fan Motor Operation

Outdoor fan motor is adjusted according to operation condition. It starts when compressor starts operation and it stops 30 seconds after compressor stops operation.

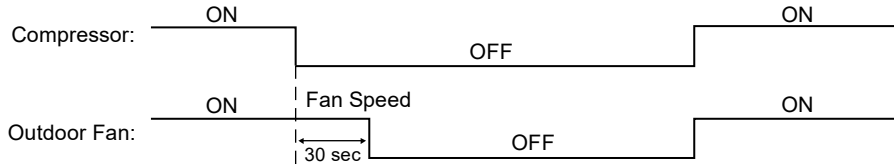

## 14.2 Water Pump

### 14.2.1 Water Pump Control

- Once the indoor unit is ON, the water pump will be ON immediately and no error judgment for 70 seconds. However, during this 70 seconds operation, if there is any abnormality cause at outdoor or malfunction, the compressor should be OFF immediately and restart delay after 3 minutes.
- The system will start checking on the water flow level after operation start for 70 seconds. If water flow level is detected low continuously 60 seconds, the water pump and the compressor will be OFF permanently and OFF/ON control panel LED will blink (H62 error occurs).
- When error happens, the power has to be reset to clear the error.
- If there is no error indication, the water pump shall be continuously running.
- The water pump will remain ON when compressor OFF due to thermostat OFF setting is reached.
- Water pump will OFF when room thermo **OR** tank thermo **OR** buffer tank thermo OFF.
- Water pump will delay 15 seconds to turn OFF when request to OFF except during anti-freeze deice activate or air purge mode.

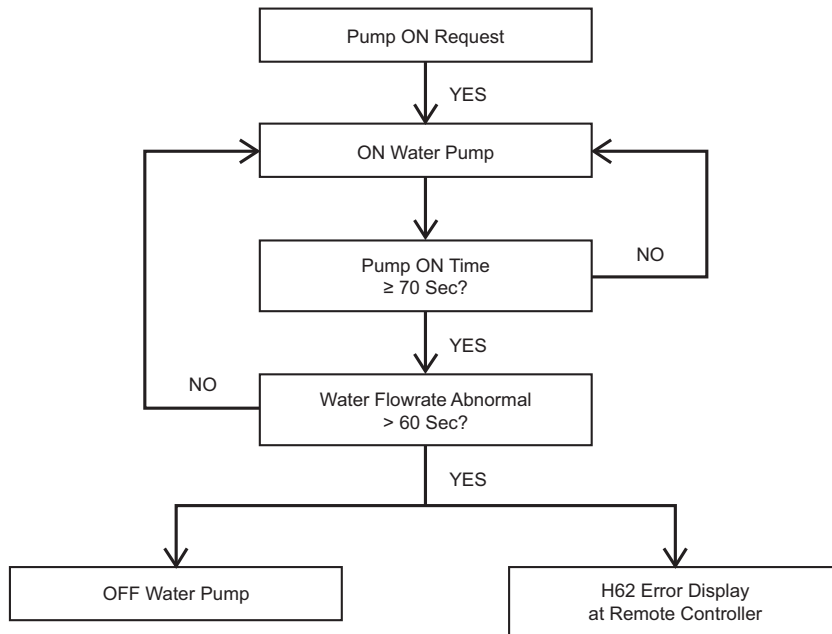

### Maximum pump speed setting on remote control

- 1) When Pump flowrate setting is  $\Delta T$   
Standard pump speed is automatically controlled to get the designed water temperature different between water inlet and outlet ( $\Delta T$ ). The maximum pump speed setting limitation can be adjusted by the installer according to water circuit pressure drop condition.
- 2) When pump flowrate setting is Max. Duty  
Indoor water pump speed will operate at the maximum pump speed setting at room side operation. The maximum pump speed setting can be adjusted by the installer according to water circuit pressure drop condition.

However, the following sequences do not follow maximum pump duty setting by remote control.

- Pump down mode
- Air purge mode
- Normal deice

## 1) P-Q graph for different pump HEX duty

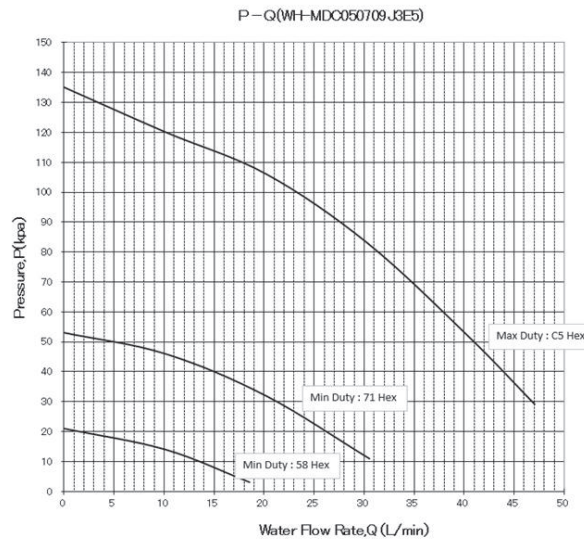

### 14.2.2 Zone Water Pump Control

Purpose:

- Water pump install at each zone to circulate the water inside each zone during buffer tank connection selected "YES" or 2 zone systems.

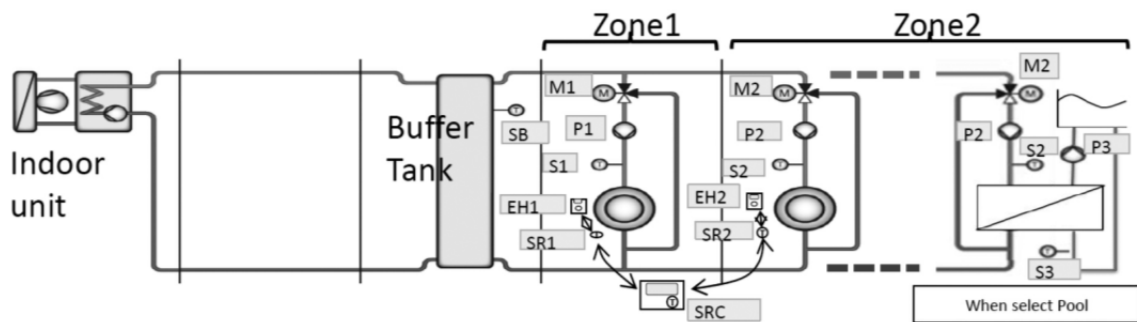

Content:

- AC type water pump install for this zone water pump control. When optional PCB connected, 230V output will drive this zone pump.
- There are three pump can be connected through Optional PCB. (Zone 1 Pump, Zone 2 Pump, & Pool Pump)
  - \* Zone 1 pump [P1] use to circulate zone 1 water circuit & Zone 1 mixing valve [M1] adjust to control the Zone 1 target water temperature.
  - \* Zone 2 pump [P2] use to circulate zone 2 water circuit & Zone 2 mixing valve [M2] adjust to control the Zone 2 target water temperature.
  - \* When Pool Function select as Zone 2 circuit, [P2] use to circulate water to heat exchanger which use to transfer heat to pool water.
  - \* Pool pump [P3] circulates the pool water through the heat exchanger to get warm water.
- Zone 1 and Zone 2 water pump start condition:
  - Zone room request ON
    - (eg. Zone 1 thermo ON, only zone 1 pump will turn ON)
- Zone 1 and Zone 2 water pump stop condition:
  - Zone room request OFF
- Pool water pump start condition:
  - Pool Zone request ON **AND**
  - Pool function is selected

- Pool water pump stop condition
  - Pool zone: Zone room request OFF **OR**
  - Pool function is cancel

\* Zone 1 & Zone 2 water pump need to turn OFF when antifreeze deice pump stop control activate and turn ON back after the antifreeze deice pump stop control end under setting of "NO" buffer tank connection.

**Zone Pump Prohibit ON control:**

- Start condition:  
Zone 1 water temperature  $\geq 75^{\circ}\text{C}$  continuously for 5 minutes  
\*stop zone water pump operates if the zone water fulfilled.
- Cancel condition:  
After 30 minutes from start condition fulfilled.  
\*zone water pump operates according to normal condition.

**Zone Pump Control during Anti-Freeze**

Zone pump control during Zone Anti-Freeze Control:

- When Zone Anti-Freeze Flag=1, Zone Pump Turn ON.
- When Zone Anti-Freeze Flag=0, Zone Pump Turn OFF.

Zone pump control during Indoor Anti-Freeze Control:

- Zone pump only ON/OFF if the Extension PCB connected and Buffer Tank select "NO" condition

When Indoor Anti-Freeze flag=1, Zone Pump Turn ON  
When Indoor Anti-Freeze flag=0, Zone Pump Turn OFF

\* Pool Water Pump will not affected by both Indoor anti-freeze control or zone anti-freeze control.

**14.2.3 Water Pump Speed Feedback Error**

- Basically pump speed feedback is control by micon.
- When pump speed is below low limit or over high limit for a few seconds, micon detect pump error and system is stopped.
- Error detection conditions:
  - Detect abnormal water pump speed for continuous 10 secs.
  - Current pump speed < 700 rpm or
  - Current pump speed > 6000 rpm for 10 seconds.
- Control contents:
  - When error occurs, water pump, heating and heater is stopped for 30 seconds then restart again (Retry control).
  - When micon detect error again, system is stopped and error code [H20] is displayed at control panel.

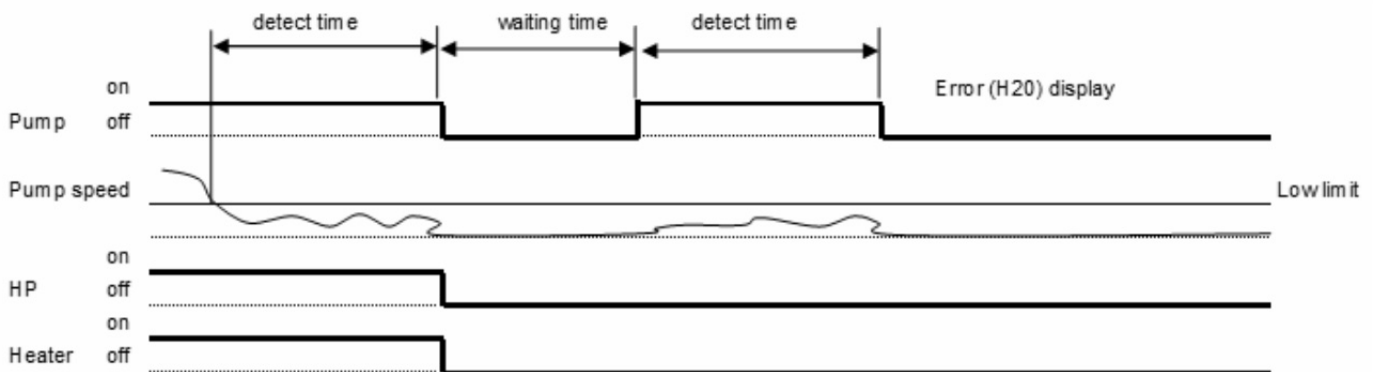

### 14.3 Indoor Unit Safety

#### 14.3.1 Indoor Unit Safety Control

- 1 When water pump is ON, the system will start checking flow switch status (ON/OFF).
- 2 If the flow switch ON for 10 seconds, the system will check on the water inlet temperature for 10 seconds. If the water inlet temperature not exceeds 80°C, the water pump shall be continuously running with normal mode.  
If the water inlet temperature exceeds 80°C for continuously 10 seconds, the water pump will be OFF immediately.
- 3 After water pump OFF for more than 10 minutes, it will be ON back and the indoor unit safety control checking is restarted.

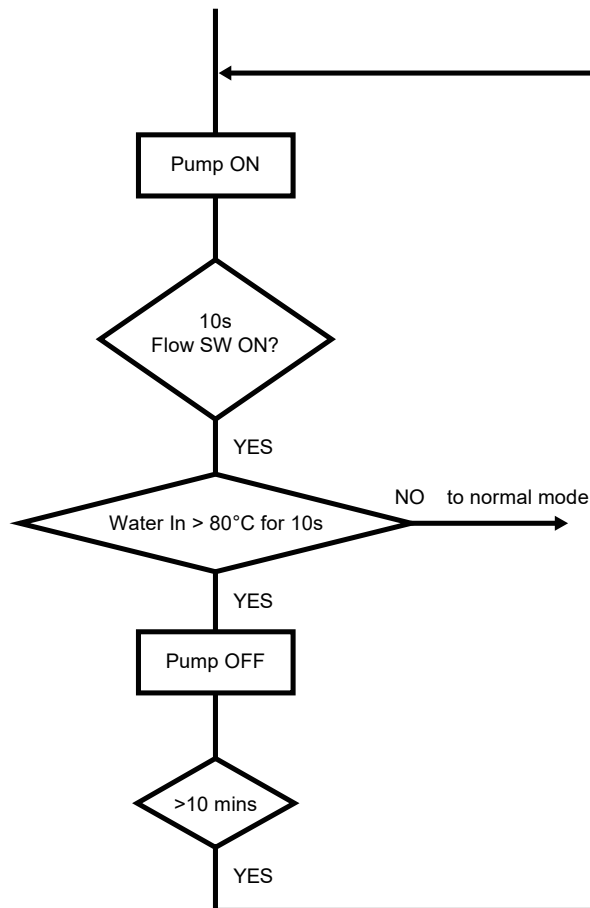

### 14.4 Auto Restart Control

- 1 When the power supply is cut off during the operation of Air-to-Water Heatpump, the compressor will reoperate after power supply resumes.

### 14.5 Indication Panel

LED	Operation
Color	Green
Light ON	Operation ON
Light OFF	Operation OFF

Note:

- If Operation LED is blinking, there is an abnormality operation occurs.

## 14.6 Indoor Back-Up Heater Control

### 14.6.1 Indoor Electric Heater Control

- 1 Normal Heating Mode
    - Heater On condition:
      - a. Heater switch is ON
      - b. After Heatpump thermo ON for Remote Control Set Delay Time mins
      - c. After water pump operate **[3]** mins
      - d. Outdoor air temperature < Outdoor set temperature for heater
      - e. When water outlet temperature < Water set temperature + Remote Control Heater ON Setting
      - f. **[20]** minutes since previous Backup heater Off
        - \* When heatpump cannot operate due to error happens during normal operation, heater will go into force mode automatic
        - \* Heater need to operate during deice operation
    - Heater Stop Condition:
      - a. When outdoor set temperature > outdoor set temperature + **[+2°C]** for continuous 15 secs OR
      - b. When water out temp > water set temperature + Remote Control Heater OFF setting for continuous 15 secs OR
      - c. Heater switch is Off OR
      - d. Heatpump thermo-off or OFF condition
  - 2 Force Heater Mode
    - Heater On condition:
      - a. After water pump operate **[3]** mins
      - b. When water outlet temperature < water set temperature + Remote Control Heater ON Setting
      - c. **[20]** minutes since previous Backup heater Off
    - Heater Stop condition
      - a. Force mode off **OR**
      - b. When water outlet temperature > water set temperature + Remote Control Heater OFF Setting for continuous 15 secs
- \* Do not operate heater at the following situation
- 1 Water outlet temperature sensor, and water inlet sensor abnormal
  - 2 Flow switch abnormal
  - 3 Circulation pump stop condition

### 14.6.2 Room Heater Operation during Deice

#### Purpose:

- To protect the indoor Heat Exchanger from ice forming and prevent heat exchanger plate breakage.

#### Control content:

- This Heater protection control will activate only if the backup heater is enable at custom setup by remote controller. Once fulfil the start condition, room heater will turn ON together (base on max heater capacity selection) and stop together if stop condition is fulfilled.
  - \* If the heater is request to turn ON OLP feedback will be detected.

#### Starting conditions:

- During normal deice operation 4~9
- Water outlet temperature < 10°C or  
Outdoor air temperature < -10°C or  
Water inlet temperature < 27°C

Heater operates when 1 ~2 fulfilled **OR** When 1 and 3 ~ 4 is fulfilled.  
However, this control does not relate to Heater ON/OFF button on remote control.

#### Stop condition:

- When normal deice end or
- Water outlet temperature > 45°C

However, room heater keeps ON if indoor electric heater control activate.



< Deice operation time chart >

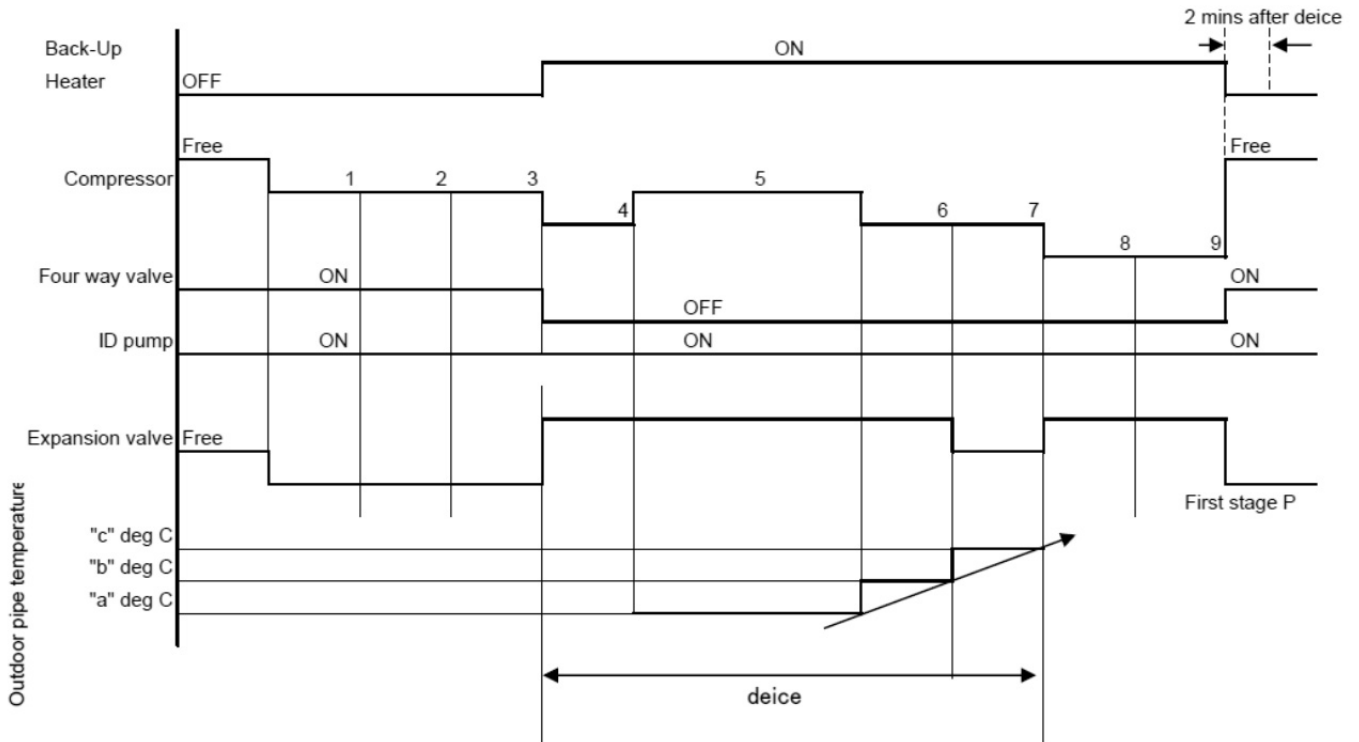

\* Backup heater must Turn OFF if the water pump turn OFF.

## 14.7 Tank Heater Control

### 14.7.1 Tank Heater Remote Control Setting

- Tank heater selection:
  - External: - Booster Heater use to heat up tank when select external
  - Internal: - Backup Heater use to heat up tank when select internal
  - \* When select External Tank Heater, Heater Delay ON Timer need to set. (range 20 min ~ 3 hrs)
- Tank Heater ON/OFF selection by user.

The remote control Tank set Temperature range will change according to the External and Internal Tank Heater use.

Tank Heater Selection	Range
External	40 ~ 75°C
Internal	40 ~ 65°C

### 14.7.2 Internal Heater Control at Tank Mode

- Internal heater turn On condition:
  - Internal Heater select for Tank heater by remote controller
  - Tank Heater select ON by user.
  - Backup Heater Enable
  - Tank Temperature < Tank Set Temperature
  - Heat Pump Thermo OFF
  - 20 minutes from previous heater off.
- Room heater turn OFF condition:
  - Tank Temperature > Tank Set Temperature + [0°C] for continuous 15 seconds. **OR**
  - Heat Pump Thermo ON **OR**
  - Mode Change or Operation OFF by remote controller **OR**

\* Backup Heater Turn ON/OFF all together according to the selected heater capacity.

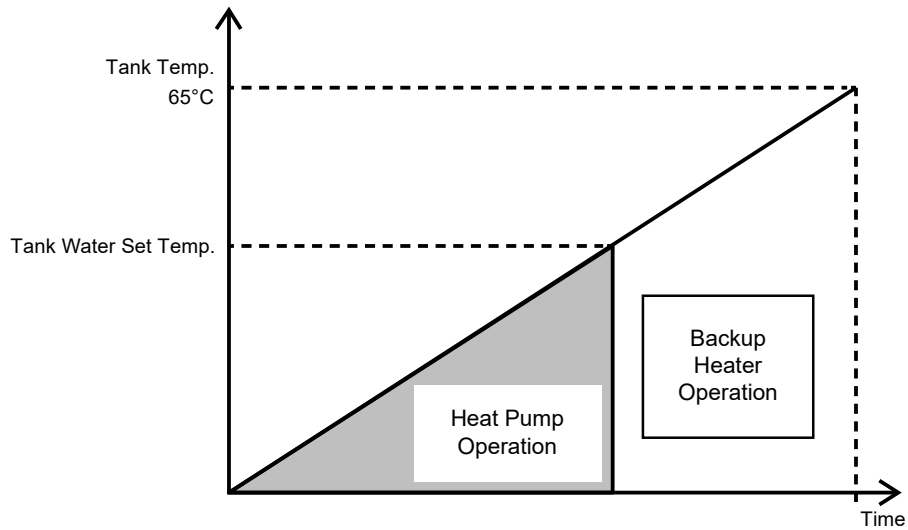

## 14.8 Base Pan Heater Control (Optional)

- To enable the base pan heater function, control panel initial setting has to be manually adjusted by activating Base Pan Heater menu.
- There are 2 optional start condition can be selected, Type A or Type B.

- Control details:

- 1 Type A: (Default Auto Mode)

Start conditions:

- When outdoor air temperature  $\leq 3^{\circ}\text{C}$  during heating and deice operation is ON.

Control contents:

- Base pan heater is ON during deice operation and continues ON for 10 minutes after deice operation ends.

Cancel condition:

- When outdoor temperature  $> 6^{\circ}\text{C}$  after deice end or
- When operation is not at heating mode or
- Base pan heater ON timer count is completed.

- 2 Type B: (ON Mode)

Start conditions:

- When outdoor air temperature is  $\leq 5^{\circ}\text{C}$  and operates in heating mode, base pan heater is ON.

Cancel conditions:

- When outdoor air temperature is  $> 7^{\circ}\text{C}$  or
- When operation is not at heating mode.

## 14.9 Force Heater Mode

Purpose of Force Heater Mode

- As a backup heat source when heat pump error. Force heater Mode control backup heater to heat up the room circuit, and turn ON back up heater or booster heater to boil up tank water base on the tank heater selection (internal or external)

Force Heater Control start condition:

- Force heater request ON by user during error OR auto turn ON by remote controller during error **AND** (Force Heater mode can be operate regardless of mode selection, remocn will send the latest mode selection force bit by bit to indoor. Indoor will judge to turn ON heater to room side if it is heat mode selected, and turn ON heater to heat tank water base on tank heater selection)
- During Error Happen (exclude the error list below)

Error List not allow Force Heater Operation

H12	Capacity Mismatch	H76	Indoor-Remote Controller Communication Error
H20	Abnormal Water Pump	H95	Abnormal Voltage Connection
H62	Abnormal Water Flow	F37	Abnormal Water Inlet sensor
H70	Abnormal Back-up Heater OLP	F45	Abnormal Water Outlet sensor
H74	PCB Communication Error		
[ When tank mode operate with external heater selected & tank heater select ON]			
H72	Abnormal tank sensor	H91	Abnormal tank heater OLP

Force Heater Control Stop Condition:

- Force Heater request OFF **OR**
- Operation OFF request **OR**
- Power reset **OR**
- Error of above list happens during force heater operation.

Control contents:

- After fulfill start condition, indoor will operate the force heater operation according to below mode condition  
Heat mode Only: Turn ON backup heater to achieve room heat pump target water temperature.  
Heat + Tank mode: Turn ON backup heater to heat up room **OR** Turn ON Heater to Boil up tank water.  
Cool mode Only: Water pump and backup heater will OFF in force heater mode.  
Cool + Tank mode: Operate pump and internal Heater OR External heater to Boil up tank water.  
Tank mode Only: Operate pump and internal Heater OR External heater to Boil up tank water.  
\* For heat mode condition, backup heater will only turn ON if the backup heater is enable regardless of Room Heater Selection  
\* For tank mode condition, If internal heater selected backup heater will turn ON to boil up tank water.  
If external heater selected, booster heater will turn ON to boil up tank water regardless of tank heater selection.

Room Side (Heat Mode):

- When force heater mode start condition fulfilled, turn ON water pump and turn ON backup heater follow below control.
- Operate the 3 ways valve at room side only and turn ON 2 ways valve as heat mode operation.
- Turn ON the zone pump and mixing valve if system select 2 zone system or Buffer tank connect YES, control according to normal zone pump and mixing valve control.
- When Force heater mode stop condition fulfilled, turn OFF heater as below condition and turn OFF water pump after pump delay time.

Backup Heater On Condition:

- When Force Heater Control start condition fulfill **AND**
- After water pump operate 2 minute **AND**
- When water outlet temperature < water set temperature + Remote Control Heater ON Setting **AND**
- 20 minutes since previous Backup heater Off **AND**
- Backup Heater Enable

Backup Heater Stop condition:

- Force mode off **OR**
- Operation off **OR**
- When water outlet temperature > water set temperature + Remote Control Heater OFF Setting for continuous 15 secs **OR**  
\* ON/OFF follow normal heater sequence.

Tank side (Tank mode):

- When tank mode select and force heater bit received, turn ON backup heater (INTERNAL) or Booster Heater (External) depend on the tank heater selection.
- If tank heater selection is INTERNAL, follow normal thermo judgement to switch 3 ways valve to tank side and room side.
- If tank heater selection is EXTERNAL, only turn ON booster heater according to tank thermo.

Tank Heater selection is INTERNAL:

Backup Heater ON Condition:

- After water pump operate 2 mins **AND**
- When tank temperature < Tank set temperature - [Remocon Set Tank Re-heat Temp] **AND**
- 20 minutes since previous backup heater OFF **AND**
- Backup heater enable

Backup Heater OFF Condition:

- Force mode OFF **OR**
- When tank temperature > Tank set temperature for continuous 15 secs **OR**
- Tank Operation OFF

Tank Heater selection is EXTERNAL:

Booster Heater ON condition:

- Force Heater mode ON **AND**
- Tank temperature < tank set temperature + [Remocon Set Tank Re-heat Temp] - 1°C, **AND**
- 20 minutes since previous heater off.

Backup Heater OFF Condition:

- Tank temperature > tank set temperature for continuous 15 sec
- Force mode OFF
- Tank Mode Operation OFF  
(During tank interval or tank mode condition, water pump and 3 ways valve will OFF)

## 14.10 Powerful Operation

Powerful mode is use to increase the capacity of heat pump to achieve higher target temperature. Powerful mode is applicable when heat mode is operating.

**Remote control setting:**

On quick menu of remote control, there is 4 options of powerful mode can be select.

- OFF : Cancel powerful mode
- 30 minutes : Set powerful for 30 minutes
- 60 minutes : Set powerful for 60 minutes
- 90 minutes : Set powerful for 90 minutes

**Control contents:**

During the time set by remote control, powerful will activate according to 2 shift up controls. However, this function is applicable only for heating. Remote control will transmit the signal to indoor unit once this function is select then transmit OFF signal to indoor when the timer is complete. Indoor will transmit signal to outdoor for frequency control.

Indoor setting temperature shift

- If system is standard system (Optional PCB is not connected)
  - Target water temperature will shift up to Wlo or Whi whichever higher.
- If system is extension system (Optional PCB is connected)
  - Target water Zone 1 and Zone 2 temperature will shift up to Wlo or Whi whichever higher.

\* If "Direct Type" temperature control is select, this powerful shift up setting is not effective.

- **Start condition**
  - Powerful function is select by remote control.
- **End Condition**
  - OFF/ON button is pressed.
  - Powerful function is OFF by remote control.

## 14.11 Quiet Operation

Quiet mode is use to reduce the noise of outdoor unit by reducing the frequency or fan speed.

### Quiet level

There are 3 level (Level 1, Level 2, Level 3) to set by quick menu function on remote control.

### Control content

Once the quiet function is select, the remote control will transmit the signal to indoor and outdoor unit.

### Start condition

- Quiet mode is set on remote control.
- Quiet mode is request ON by weekly timer.

### Stop condition

If any of below condition is achieve.

- OFF/ON button is pressed.
- Quiet mode is OFF by remote control.
- Quiet mode is request OFF by weekly timer.

## 14.12 Sterilization Mode

- Purpose:
  - To sterilize water tank by setting the required boiling temperature.
- Remote control setting
  - Days for sterilization function to start can be select.
  - Time of selected day to start sterilization function.
  - Boiling temperature (Internal heater is 55°C ~ 65°C)
  - Maximum operation time is 5 minutes to 1 hour.
- Start condition
  - Tank connection set to "YES" by remote control
  - Sterilization function selects "YES".
  - Sterilization signal received from remote controller by timer.
  - Tank mode request ON.
- Stop condition
  - When boiling timer is completed. Boiling timer (Remote control set maximum operation time) start counting once tank achieve boiling set temperature **OR**
  - After 8 hours of operation since sterilization start.
  - Tank mode request OFF.
- Control content:
  - During sterilization function activation time, target tank set temperature will internally change to boiling set temperature.
  - During sterilization activates, heat pump and heater (external or internal) will operate as normal tank mode to achieve the boiling set temperature.
  - Sterilization operation will end when stop condition is fulfill.
  - After sterilization is complete, tank set temperature will resume to normal operation.

\* Tank temperature may not achieve boiling set temperature if tank heater is select OFF **OR** external compressor switch.

## 14.13 Outdoor Ambient Thermo OFF Control

- Purpose
  - Stop provides heating to room side during high outdoor ambient condition.

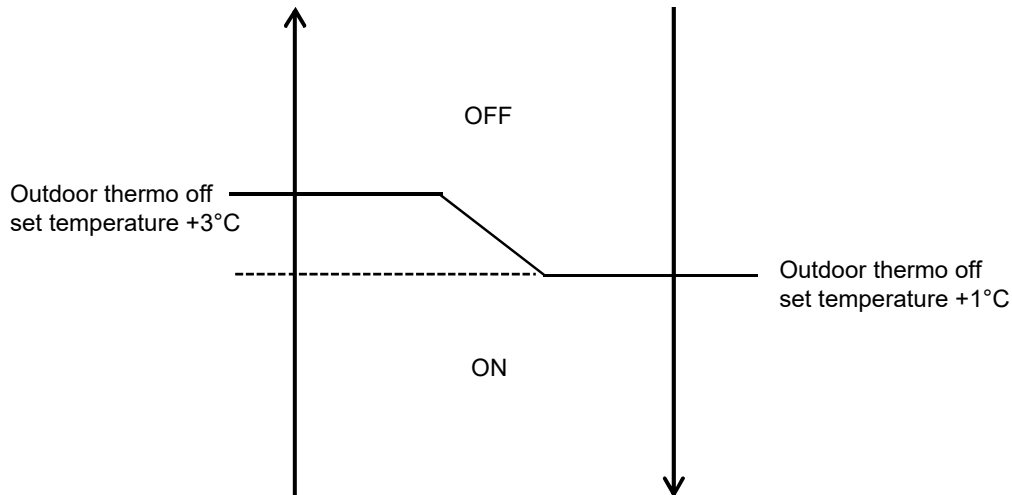

- Control content
  - Heating outdoor ambient thermos OFF control only applicable when heat pump operate in heat mode. (This control will not activate when running in tank side)
  - Heat pump and water pump will turn OFF when outdoor ambient is higher than outdoor thermo OFF set temperature.
  - Heat pump thermos ON when outdoor ambient < outdoor thermos OFF set temperature + 1°C.

## 14.14 Alternative Outdoor Ambient Sensor Control

### Purpose of the Alternative Outdoor Ambient Sensor:

- It is some possibility that the air to water heat pump unit will install at a location where the original ambient sensor is expose to direct sunlight. Therefore, another optional ambient sensor can be connect to indoor PCB and locate at new and better reading location to improve the heat pump performance.

### Control Detail:

- Remocon can select either the extra outdoor ambient sensor is connected or not. (YES/NO)
- The alternative outdoor ambient sensor will connect to indoor unit main PCB terminal.
  - when alternative sensor select NO
    - Original Outdoor temperature sensor will use for Indoor & Outdoor heat pump operation reference sensor.
    - Data communication direction : OUTDOOR send outdoor temperature reading to INDOOR.
    - Error judge : OUTDOOR will judge the original outdoor sensor error (F36 display if error detect). No judge error on alternative outdoor sensor
  - when alternative sensor select YES
    - Alternative Outdoor temperature sensor will use for Indoor & Outdoor heat pump operation reference sensor.
    - Data communication direction : INDOOR send outdoor temperature reading to OUTDOOR.
    - Error judge : INDOOR will judge the Extra outdoor sensor error only after operation ON request received from remocon. (F36 display if error detect). No judge error on original outdoor sensor.

## 14.15 Force DHW mode

Purpose:

When user want to use hot water now, user can press this force DHW mode under the quick menu to operate tank only mode to boil up the tank temperature.

Remocon setting:

Force DHW function can be activate under quick menu.

Control Content:

- when press the Force DHW function during operation OFF condition:
    - When receive this Force DHW bit from remocon, indoor will run tank only mode regardless of the mode selection.
    - After tank temperature achieve tank thermo off temperature, turn OFF force DHW bit and return to operation OFF with previous mode selection.
  - When press the Force DHW function during operation ON condition:
    - When receive this Force DHW bit from remocon, indoor will memories the running mode and run tank only mode regardless of the mode selection.
    - After tank temperature achieve tank thermo off temperature, turn OFF force DHW bit and return to previous memories running mode.
- \* when operation OFF or mode change request from remocon during force DHW mode operation, End force DHW mode and follow the new request operation.
- \* Once receive force DHW mode from remocon, indoor direct start tank mode and consider tank thermo ON. Thermo OFF only when achieve tank thermo OFF depend on the Tank System Setting.

## 14.16 SMART DHW mode

Panasonic All In One model provide the option to choose STANDARD DHW Mode or SMART DHW Mode for Tank Heat Up according to requirement. SMART DHW mode comparatively consume lower tank heat up power but longer re-heat time than STANDARD DHW Mode.

### SMART DHW control

- During SMART DHW start time 20:00 (Default Setting) to SMART DHW stop time 05:00 (Default setting) Heat pump re-heat the tank water only when tank temperature drop below 20°C (Default setting)
- Time between 05:00 to 20:00 Heat pump reheat the tank water when tank temperature as below condition

Condition 1: Tank Heater ON

Reheat when tank temperature below tank set temperature + R/C (Tank re-heat Temperature) - 3°C

Condition 2: Tank Heater OFF

Reheat when tank temperature below Tank set temperature or 52°C (Whichever lower) + R/C (Tank re-heat Temperature) -3°C

\* SMART DHW start time, stop time and SMART ON Temperature can change in CUSTOM menu.

### STANDARD DHW Mode

- Heat pump always reheat the tank water when tank temperature as below condition

Condition 1: Tank Heater ON

Reheat when tank temperature below tank set temperature + R/C (Tank re-heat temperature)

Condition 2: Tank Heater OFF

Reheat when tank temperature below Tank set temperature or 52°C (Whichever lower) + R/C (Tank re-heat temperature)

## 14.17 DHW Capacity Setting

DHW Capacity is heat pump heating capacity output control during tank boiling operation. There are two DHW capacity setting (VARIABLE & STANDARD) which can be set in remote control.

### VARIABLE DHW Capacity:

- Heat pump operate with efficient (Low) Capacity to boil tank temperature during re-heat process. And heat pump regulated to operate with high capacity to boil tank temperature when tank temperature drop below 25°C.

### STANDARD DHW Capacity:

- Heat pump operate according to outdoor rated heating capacity during tank boiling process.

## 14.18 Anti Freeze Control

- Anti freeze protection control menu can be set YES or NO by control panel.
- In heatpump system, there are 3 types of anti freeze control:
  1. Expansion tank anti-freeze control
    - Expansion tank anti freeze heater ON condition:
      - Outdoor ambient temp. < 3°C
    - Expansion tank anti freeze heater OFF condition:
      - Outdoor ambient temp. > 4°C
  2. Water pump circulation anti freeze control
    - Water pump turns ON when **ALL** below conditions are fulfilled:
      - Heatpump OFF (stand by) OR error occurs.
      - Water flowing flag is ON.
      - Water flow switch is not abnormal.
      - Outdoor ambient temp. < 3°C OR outdoor ambient temp. sensor is abnormal.
      - Water inlet/outlet temp. < 6°C.
      - After 5 minutes from previous water pump OFF.
    - Water pump turn OFF when **ANY** of below conditions is fulfilled:
      - Outdoor ambient temperature  $\geq 4^{\circ}\text{C}$ .
      - During  $-5^{\circ}\text{C} < \text{outdoor ambient temp.} < 4^{\circ}\text{C}$ 
        - After water pump ON for 4 minutes, and water inlet temp.  $\geq 8^{\circ}\text{C}$ .
        - Else, shift to back up heater anti freeze control.
      - During outdoor ambient temp. <  $-5^{\circ}\text{C}$ 
        - After water pump ON for 4 minutes, and water inlet/outlet  $\geq 20^{\circ}\text{C}$ .
        - Else, shift to back up heater anti freeze control.
    - However, if flow switch is abnormal (H62), then water pump circulation anti freeze control will not activate.
  3. Back up heater anti freeze control:
    - Back up heater turn ON when **ALL** below conditions is fulfilled:
      - Water inlet/outlet temp. < 6°C.
      - Water pump circulation anti freeze control activated and water pump ON for 4 minutes.
    - Back up heater turns OFF when ANY of below conditions is fulfilled:
      - Water inlet/outlet temp. > 28°C.
      - Water pump circulation anti freeze control deactivated/water pump OFF.
    - However, if back up heater is abnormal (H70) then back up heater anti freeze control will not activate.



### 14.18.1 Zone Anti-Freeze Control

- If buffer tank selection is "NO" and Anti-Freeze function select "NO" from remote control, this control cannot activate.

Start condition:

- After [5] min from previous Zone pump off. **AND**
- Outdoor air temp < [3] °C **OR** Outdoor sensor is abnormal. **AND**
- Zone water temperature < [6]°C **OR** Zone Sensor Short or Open

Cancel condition:

- After water Zone pump ON [4] min **AND**
  - Outdoor air temp ≥ [4]°C **OR**
  - During -5 °C ≤ Outdoor air temp < [4] °C **OR**  
Zone water temperature sensor > [8] °C
  - During Outdoor air temp < [-5] °C  
Zone water temperature sensor > [20] °C
- \*However, Zone water temperature sensor is Open or Short, Condition C and D is ignored.

### 14.19 Solar Operation (Optional)

#### 14.19.1 Solar Operation:

Solar function:

- This function allow user to control the solar pump to operate depend on the solar sensor reading compare to the tank installed. Solar pump will circulate the hot water energy store at solar panel to heat up the DHW Tank or Buffer Tank.

Solar Connection Diagram:

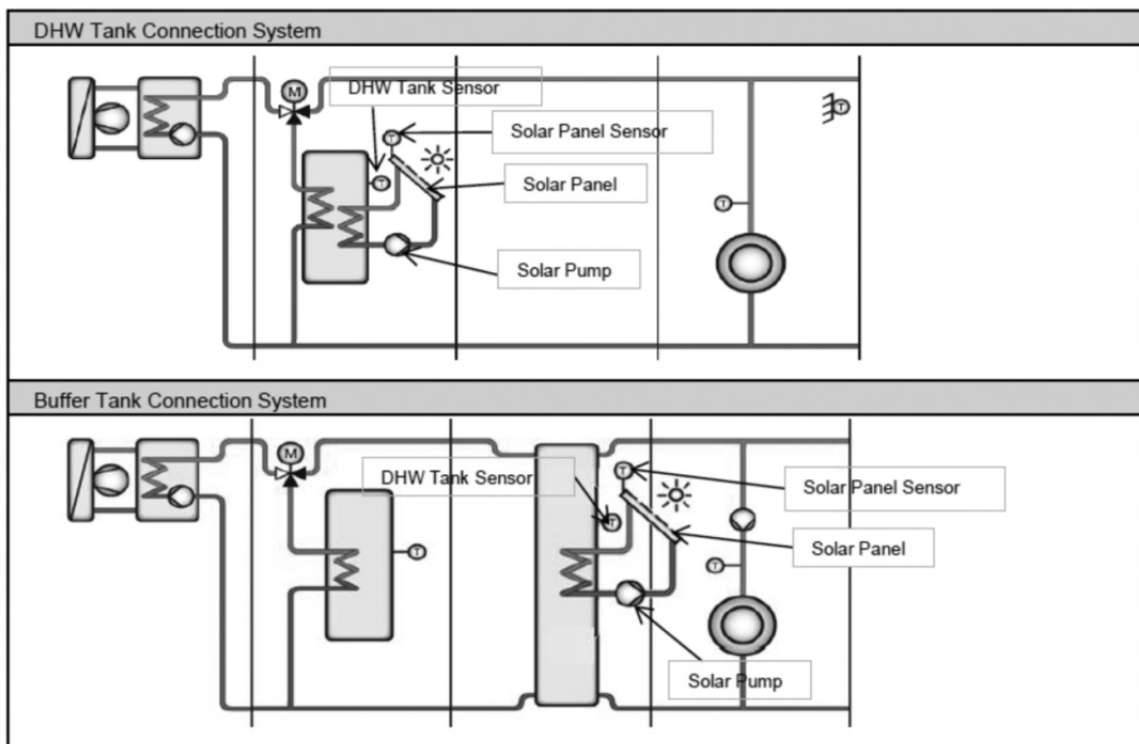

- Solar function can only enable when the Optional PCB is connected.
  - Few part as below need to install to control the solar operation:
    - Solar Panel
    - Solar Pump
    - Solar Panel Sensor
    - Tank Sensor (Buffer tank sensor OR DHW Tank sensor depend on the connection direction)
- \* During Solar Connection to the system, installer need to alert on the high water temperature may flow to the zone circuit or DHW piping circuit. Therefore pipe which withstand higher water temperature need to be installed.

- Solar remote control setting
  - 1 Solar Setting can only be set when the optional PCB connection is select "YES"
  - 2 By remote controller, Setting as below list can be set for solar function operation (Installer Menu)
    - Solar Function ("YES" or "NO")
    - Tank Connection Direction ("DHW TANK" or "BUFFER TANK")
    - Delta T turns ON: Difference temperature setting between solar panel sensor and Tank to turn on solar pump. (Range :5 ~ 15°C)
    - Delta T turns OFF: Difference temperature setting between solar panel thermistor and Tank to turn off solar pump. (Range :2 ~ 10°C)
    - Outdoor temp for Anti-Freeze : Outdoor temp to start Anti-Freeze control for solar circuit. (Range : -20 ~ 10°C)
    - Tank Temperature HI Limit Set (Range : 70 ~ 90°C)

#### 14.19.2 Solar Operation Control

- Solar function can only be activate if the solar function selection "YES" from remote control. To achieve hot water from solar panel, indoor need to control the solar pump and circulate hot water from solar panel.

##### Under normal case:

- Solar pump start condition:
  - Solar panel temperature > Delta T turn on setting temp (R/C) + Tank temperature (depend on selection, DHW or Buffer) **AND**
  - Tank temperature (DHW or Buffer) < Solar HI Limit Temp (R/C) **AND**
  - Operation ON with heat mode (apply to solar connect to "Buffer Tank" case)

\* Condition c) ignore if the solar system is connect to DHW tank (control active under operation OFF time for Tank connection case)
- Solar pump stop condition:
  - Solar panel temperature < Delta T turn OFF setting temp (R/C) + Tank temperature (depend on selection, DHW or Buffer) **OR**
  - Tank hot water temp >= Solar HI Limit Temp (R/C) + [2]°C

##### Under solar Anti-freeze protection control:

- Solar pump start condition:
  - Outdoor temp < Outdoor temp setting for Anti-Freeze (R/C)
- Solar pump stop condition:
  - Outdoor temp > Outdoor temp setting for Anti-Freeze + [2]°C

\*\*However, During Cool mode this function cannot activate if Tank selection is "Buffer Tank".

\*\*Solar pump can operate even if Heat pump is under error stop.

- Solar operation during error:
  - During Tank sensor (DHW or Buffer depend on selection) abnormal, Solar operation will not able to function.
  - During Solar Panel sensor detect OPEN (not include SHORT), Solar operation will not able to function too.

## 14.20 Boiler Bivalent Control

- Boiler is an additional or alternative heat source to heat up the room when necessary.
- Purpose of this control is to turn ON and turn OFF the Boiler output signal when boiler heating capacity needed in the system.
- Boiler is possible to connect to DHW Tank and Buffer Tank depends on the installer.
- Boiler operation parameter need to be set on Boiler itself, indoor do not control the boiler operation direction and operation.
- There is two option of control pattern can be set by remote controller : AUTO OR SG ready Mode

### AUTO Control Mode:

- There are Alternative mode, Parallel mode, & Advance Parallel mode available to select by installer to fit to the total system.

### **Bivalent control selection by remote controller**

#### Remote control setting value:

1 Outdoor Ambient Set = (Range: -15°C ~ 35°C)

- **Alternative Mode**

- Only one heat source operates at one time, either heat pump or boiler depends on condition.
- External pump will turn ON when the external pump selection is ON when boiler is ON even heat pump is OFF.

#### Control detail:

During Operation ON at Heat mode or Tank mode or Heat + Tank Mode

- Boiler signal turn ON and heat pump and water pump turn OFF when:
  - Outdoor ambient < Outdoor Ambient Set **AND**
  - Boiler prohibit flag = 0

\*\* However indoor water pump can operate when Anti-freeze control condition fulfilled.

- Boiler signal turn OFF and heat pump and water pump turn ON when:
  - Outdoor ambient > Outdoor Ambient Set + [2°C] **OR**
  - Boiler prohibit flag = 1

- **Parallel Mode**

- Parallel mode allows heat pump and boiler ON at the same time. Boiler operates as an additional heating capacity when low heat pump capacity at low ambient condition.

#### Control detail:

During operation ON at Heat mode or Tank mode or Heat + Tank mode

- Boiler signal turns ON when:
  - Outdoor ambient < Outdoor Ambient Set **AND**
  - Boiler prohibit flag = 0
- Boiler signal turns OFF when:
  - Outdoor ambient > Outdoor Ambient Set + [2°C] **OR**
  - Boiler prohibit flag = 1

- **Advance Parallel Mode**

- Advance parallel mode allow heat pump to operate and turn ON boiler only when ambient and temperature condition is fulfilled.

#### Remote control setting value:

1 Outdoor Ambient Set = (Range : -15°C ~ 35°C)

2 Selection of boiler connection direction. (Heat only, DHW only, Heat & DHW)

3 Setting data under Heat Direction

- Start Temperature | START\_TEMP |
- Start Delay Timer | START\_TIMER |
- Stop Temperature | STOP\_TEMP |
- Stop Delay Timer | STOP\_TIMER |

4 Setting data under DHW Direction

- Delay Timer | DELAY\_TIMER |

Control detail:

During operation ON at Heat Mode

- Boiler signal turns ON when
  - Outdoor ambient < Outdoor Ambient Set **AND**
  - Buffer tank temperature < Target Buffer Tank Temperature + [START\_TEMP] for [START\_TIMER] **AND**
  - Heat pump operate at room side **AND**
  - Connection of Boiler to Heating Select "YES" From installer menu **AND**
  - Buffer Tank connection select "YES" **AND**
  - Boiler prohibit flag = 0
- Boiler signal turns OFF when
  - Outdoor ambient > Outdoor Ambient Set + [-2°C] **OR**
  - Buffer Tank temperature > Target Buffer Tank temperature + [STOP\_TEMP] for [STOP\_TIMER] **OR**
  - Heat pump not at room side. **OR**
  - Boiler prohibit flag = 1

During operation ON at Tank Mode

- Boiler signal turns ON when
  - Outdoor ambient < Outdoor Ambient Set **AND**
  - Heat pump operate at tank side for continuous | DELAY\_TIMER | **AND**
  - Connection of Boiler to DWH Tank select "YES" from installer menu. **AND**
  - Boiler prohibit flag = 0
- Boiler signal turns OFF when
  - Outdoor ambient > Outdoor Ambient Set + [2°C] **OR**
  - Heat pump not operates at tank side. **OR**
  - Boiler prohibit flag = 1

**SG ready Control Mode:**

- Using same SG ready from Sub Board input to control boiler ON/OFF output.
- \* When this SG ready is select for bivalent control, default SG ready function will change to control bivalent output.
- Remote controller can set the External Pump ON/OFF like bivalent alternative mode.

Control Content

Indoor will follow the SG ready bit input to control ON/OFF heat pump and boiler

00	: Heat pump OFF, Boiler OFF	10	: Heat pump OFF, Boiler ON
01	: Heat pump ON, Boiler OFF	11	: Heat pump ON, Boiler ON

\* External pump will turn ON when the external pump selection is ON when boiler is ON even heat pump is OFF.

**Boiler prohibit flag control**

Purpose:

- For product safety. Boiler signal is OFF when water temperature is too high.

Start condition:

- Water outlet ≥ 85°C continues for 5 minutes.
- Water inlet ≥ 85°C continues for 5 minutes.
- Zone1 water temp ≥ 75°C continues for 5 minutes.
- Zone2 Water temp ≥ 75°C continues for 5 minutes.

Contents:

- After start condition fulfilled, set boiler prohibit flag = 1

Cancel condition:

- After 30 minutes from start condition fulfilled.

Contents:

- Set boiler prohibit flag = 0

## 14.21 External Room Thermostat Control (Optional)

Purpose:

- Better room temperature control to fulfill different temperature request by external room thermostat.  
Recommended external room thermostat:

Maker	Characteristic
Siemen (REV200)	Touch panel
Siemen (RAA20)	Analog

Connection of external room thermostat:

Wire Connection and thermo characteristic of Siemen REV200:

Setting	L/L1 (H)	Heat Thermo	L/L2 (C)	Cool Thermo
Set Temp < Actual Temp	Open Circuit	OFF	Short Circuit	ON
Set Temp > Actual Temp	Short Circuit	ON	Open Circuit	OFF

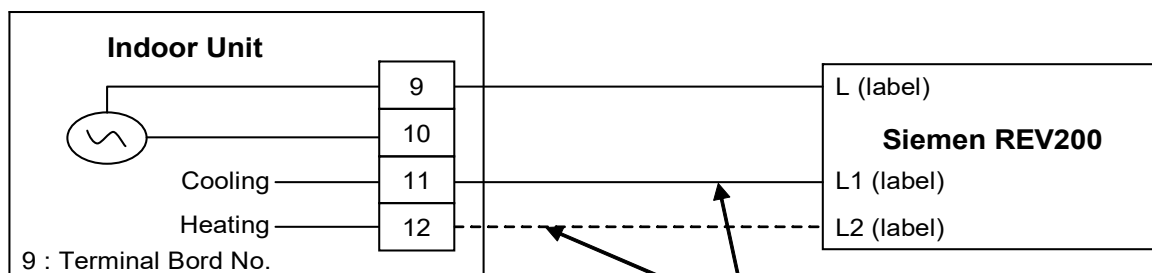

Connect only heating line for heating only model. And connect both heating and cooling line for heat + cool model.

Wire Connection and thermo characteristic of Siemen RAA20:

Setting	L/Y1 (H)	Heat Thermo	L/Y2 (C)	Cool Thermo
Set Temp < Actual Temp	Open Circuit	OFF	Short Circuit	ON
Set Temp > Actual Temp	Short Circuit	ON	Open Circuit	OFF

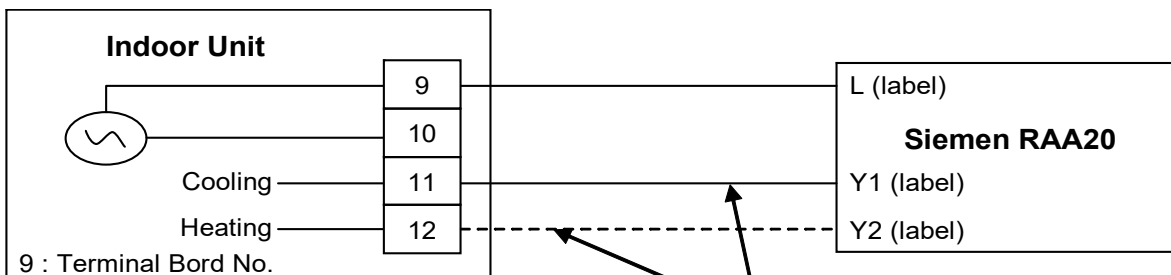

Connect only heating line for heating only model. And connect both heating and cooling line for heat + cool model.

Control Content:

- External room thermostat control activate only when remote thermostat connection select YES by Indoor control panel.
- When indoor running heat mode, refer thermo On/Off from heating line feedback. And when indoor running cool mode, refer thermo On/Off from cooling line feedback.
- Heat pump Off immediately when receive thermo off feedback.

## 14.22 Three Ways Valve Control

### Purpose:

- 3 ways valve is used to change flow direction of hot water from heat pump between heating side and tank side.

### Control contents:

- 1 3 ways valve switch Off:
  - o During 3 ways valve switch Off time, the hot water will provide heat capacity to heating side.
- 2 3 ways valve switch On:
  - o During 3 ways valve switch On time, the hot water will provide heat capacity to tank side.
- 3 Stop condition:
  - o During stop mode, 3 ways valve will be in switch off position.

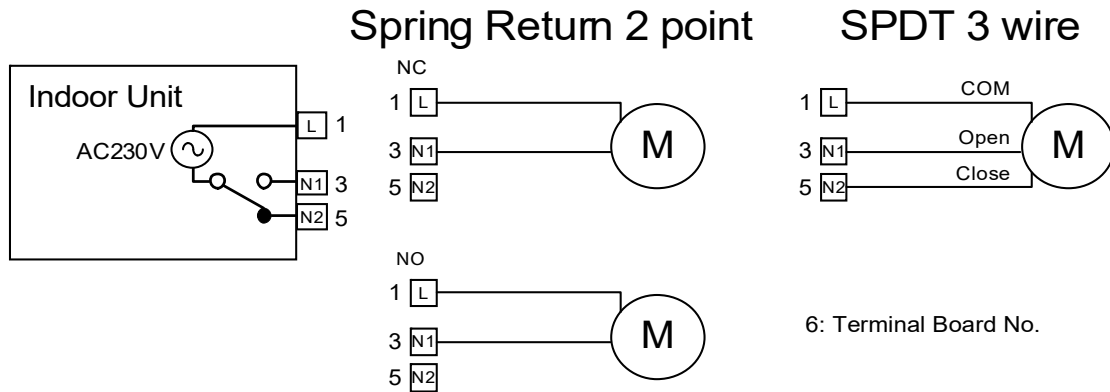

6: Terminal Board No.

\* During pump down and force mode, fix 3 ways valve in close condition.

\* Recommended Parts : SFA 21/18 (Siemens)

## 14.23 Two Ways Valve Control

### Functionality of 2 ways valve:

- Use to allow hot water to floor heating panel or block cold water to floor heating panel.

### Control contents:

- 1 When indoor running in heat mode, OPEN the 2 ways valve.
- 2 When indoor running in cool mode, CLOSE the 2 ways valve.
- 3 Stop condition:
  - a. During stop mode, fix 2 ways valve in close condition.

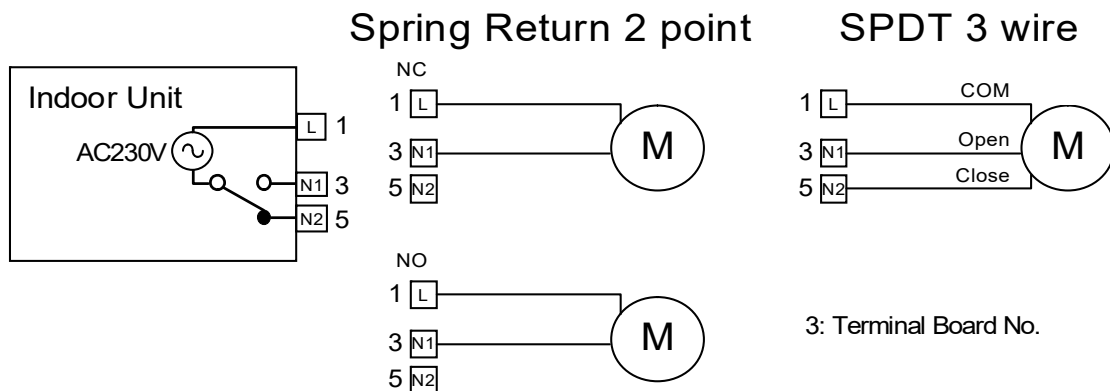

3: Terminal Board No.

\* During pump down mode, fix 2 ways valve in close condition.

\* During force mode, open 2 ways valve.

\* Recommended Parts : SFA 21/18 (Siemens)

## 14.24 External OFF/ON Control

- Communication circuit between indoor unit and external controller is as per below.

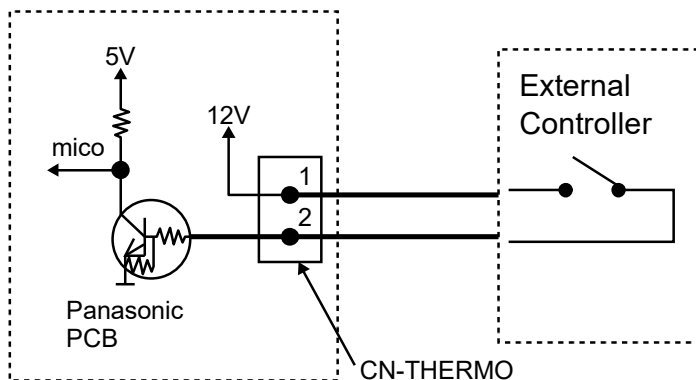

- Maximum length of communication cable is 50 meter.
- Control content:

External Control Switch	Control Panel OFF/ON	Control Panel Power LED	System Status
ON	ON	ON	ON
ON	OFF	OFF	OFF
OFF	ON	ON	OFF
OFF	OFF	OFF	OFF

### Remocon Screen Display and Control Detail:

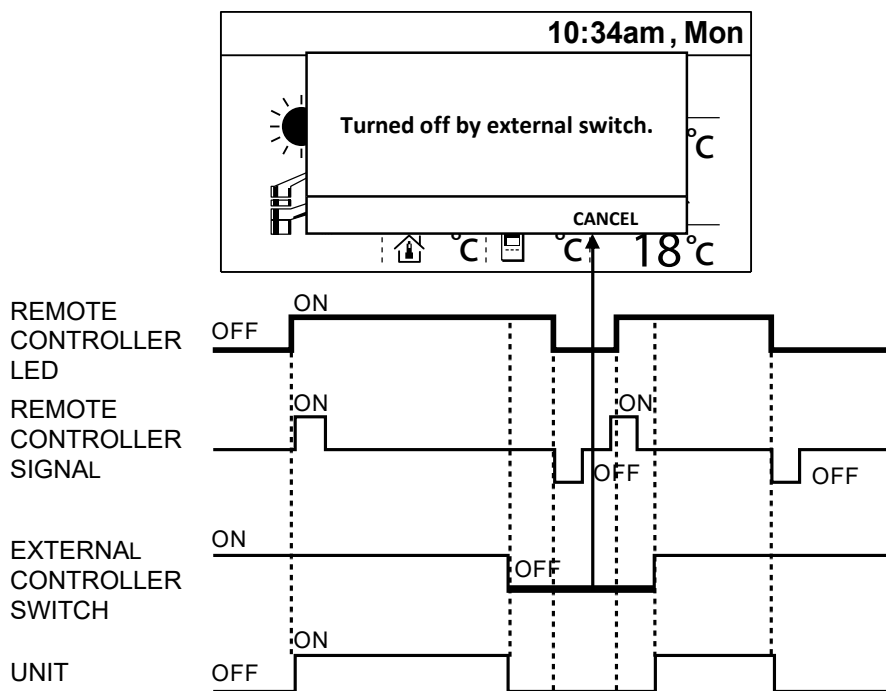

When External SW connection select "YES" from remocon installer menu:

- Heating or Cooling system will operate normally if the External Switch signal is ON.
- Once the External Switch turn OFF, System Turn OFF ( Heat pump, water pump, heater etc...)
- Remocon LED remain ON or OFF according to the current operation request.
- Pop up menu at remocon main screen as above screen to inform customer system stop by External Switch.
- It is possible to press cancel and return to main screen to do change of operation setting while waiting the External Switch turn ON back.
- Remocon LED will always follow the latest changes from remocon.
- If no action on remocon for continuous 5 minutes, the pop up screen will show again on the screen.
- But once the External Switch Turn ON back, pop up screen will disappear and system can operate normally according to the latest operation setting and request.

## 14.25 External Compressor Switch (Optional PCB)

External compressor switch port can have two purpose of control as below:

- Heat source ON/OFF function (Dip switch Pin 3 on PCB "OFF")
- Heater ON/OFF function (Dip switch Pin 3 on PCB "ON")
  
- Heat source ON/OFF function

Purpose:

- Heat pump ON/OFF function is use to turn OFF the high power consumption device (Heat pump, & Heater) when there is energy or electric current limitation. Other optional function still can be operate under heat pump and heater OFF condition.

Control Detail:

- This External Compressor Switch is possible to connect to Optional PCB only.
- Once the remocon select External Compressor Switch connection "YES", & Dip Switch on PCB "OFF" This heat pump ON/OFF function will activate
- The ON/OFF signal of this External Compressor Switch is same as External Switch.
- When the External Compressor Switch is ON:
  - Heat pump system operate normally
- When the External Compressor Switch is OFF:
  - Heat pump, Indoor water pump & Heater ( Booster heater & Backup Heater ) need to turn OFF
  - Solar, Boiler and zone control can be operate follow normal control condition.
    - \* pump delay OFF also included in this control

(There is NO pop up screen like External Switch when this External Compressor Switch is OFF.)

- Heater ON/OFF function

Purpose:

- Heater ON/OFF function is use to turn OFF the heater (backup heater & booster heater) when there is energy or electric current limitation. Heat pump and other optional function still can operate.

Control detail:

- This External Compressor Switch is possible to connect to Optional PCB only.
- Once the remocon select External Compressor Switch connection "YES", & Dip Switch on PCB "ON" This heater ON/OFF function will activate
- When the External Compressor Switch is ON:
  - Heat pump and heater operate normally
- When the External Compressor Switch is OFF:
  - Backup heater and booster heater cannot operate even heater request is ON.
  - Heat pump and option function (Solar, Boiler and zone control) can be operate follow normal control condition.

(There is NO pop up screen like External Switch when this External Compressor Switch is OFF.)



## 14.26 Heat/Cool Switch (Optional PCB)

Purpose:

- User can switch the running mode from heat to cool or cool to heat through external installed Heat/Cool switch. This kind of heat / cool switch may be built in inside the field supply room remote control as well.

Control contents:

- Heat/Cool Switch can only be set when Cool Function is "enable" at custom menu setting, & Extension PCB select "YES" & Zone 1 not set "Pool" condition.
- This heat/cool switch control will be activated only when installer sets the Heat/Cool Switch "USE" through remote control.
- Once the Heat/Cool Switch is set "USE", remote control will check indoor send signal to judge the option of mode selection.
  - When Heat/Cool Switch Contact Open : Remote control only can select Heat Mode, or Heat + Tank Mode, or Tank Mode
  - When Heat/Cool Switch Contact Close : Remote control only can select Cool Mode, or Cool + Tank Mode, or Tank Mode
- Operation ON/OFF will depend on remote control request.
- When Heat Mode is running with Contact Open, user changes this setting to contact close, indoor will receive this signal to remote control judge and change mode to cool and send back to indoor. And it is the same as from cool mode change to heat mode.
  - \* This switch has higher priority, remote control follows indoor send signal when control is activated.
  - \* There is no effect to the operation when the mode running is only Tank Mode.

(Weekly Timer are ignored and cannot be set during Heat / Cool Switch is "Enable" Condition.)

## 14.27 SG Ready Control (Optional PCB)

Purpose:

- To set ON/OFF of heat pump and target temperature by digital input of third party device if necessary in field.

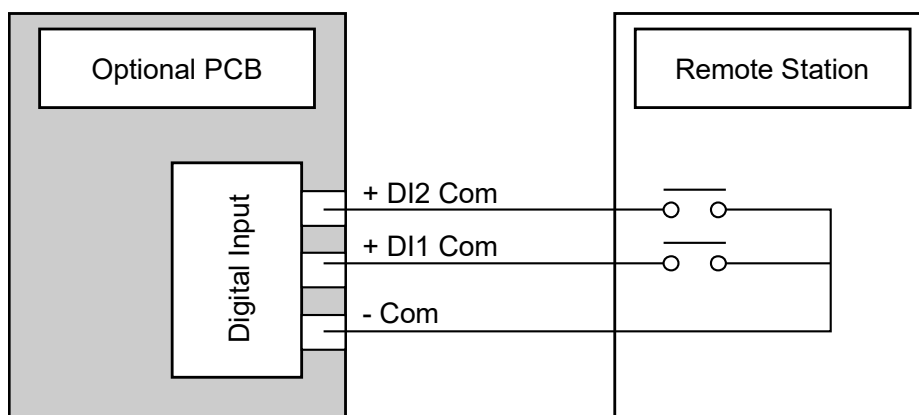

Remote control setting

For this function, following items need to be set on R/C (installer menu) –

- SG control = YES or NO
- Capacity up setting 1
  - Heating capacity [50 ~ 150 %]
  - DHW capacity [50 ~ 150 %]
- Capacity up setting 2
  - Heating capacity [50 ~ 150 %]
  - DHW capacity [50 ~ 150 %]

## Control contents:

If SG control on remote control = "Yes", then following control only activate by digital input.

- **While Digital input is " 00 " (Normal operation)**
  - Normal operation. Once detect '00' system will operate back to normal condition.  
(All the target set temperature for heating side and DHW side will return back to previous set temperature when digital signal change from "10' or"11" back to "00".)
- **While digital input is detected " 01 " (HP stop)**
  - Heat pump & room heater & tank heater cannot operate.  
**(Solar control and Boiler back up and 2 Zone control can activate.)**
- **While digital input is detected " 10 " (Capacity 1)**
  - Target temperature for heating and DHW Tank is changed according to the percentage set by Remote control setting. However, which setting temperature is change depend on system setting.
- **While digital input is detected " 11 " (Capacity 2)**
  - Target temperature for heating and DHW Tank is changed according to the percentage set by Remote control setting. However, which setting temperature is change depend on system setting.
- **While digital input is detected " 10 " (Capacity 1)**
  - Setting temperature for heating and Tank is changed.  
However, which setting temperature is change depend on system setting.

### **If Buffer selection is "YES"**

#### Room side

New Target Buffer tank temperature = Current Target Buffer Tank Temperature \* Remote Control setting (" capacity 1) %

\* Max Min regulation is follow Target Buffer tank temperature control specification

\*\* No change of Target zone water temperature, only set higher buffer tank temperature.

#### DHW Tank side

New Tank Set Temperature = Tank Set Temperature \* Remote Control setting for DHW ("Capacity 1) % \*  
(Max regulation depend on the tank max setting limit)

### **If Buffer selection is "NO"**

#### Room side

New Target Zone Water Temperature = Current Target Zone Water Temperature \* Remote Control Setting (\*Capacity 1) %

(Zone 1 and Zone 2 will change according to its own target zone water temperature.)

(Max regulation depend on the temperature control type select)

#### DHW Tank side

New Tank Set Temperature = Tank Set Temperature \* Remote Control setting for DHW ("Capacity 1) %

\* (Max regulation depends on the tank max setting limit)

Setting temperature for cooling is changed.

New Target Water Temperature = Target Water Temperature + Remote Control setting for cool (\*Capacity 1)

\* (Min/Max regulation of cooling water set apply)

- **While digital input is detected " 11 " (Capacity 2)**
  - Setting temperature for heating and Tank is changed.  
However, which setting temperature is change depend on system setting.

### **If Buffer selection is "YES"**

#### Room side

New Target Buffer tank temperature = Current Target Buffer Tank Temperature \* Remote Control setting (" capacity 2) %

\* Max Min regulation is follow Target Buffer tank temperature control specification

\*\* No change of Target zone water temperature, only set higher buffer tank temperature.

#### DHW Tank side

New Tank Set Temperature = Tank Set Temperature \* Remote Control setting for DHW ("Capacity 2) %

\* (Max regulation depends on the tank max setting limit)

## If Buffer selection is "NO"

### Room side

New Target Zone Water Temperature = Current Target Zone Water Temperature \* Remote Control Setting (\*Capacity 2) %

(Zone 1 and Zone 2 will change according to it's own target zone water temperature.)

(Max regulation depend on the temperature control type select)

### DHW Tank side

New Tank Set Temperature = Tank Set Temperature \* Remote Control setting for DHW ("Capacity 2) %

\* (Max regulation depends on the tank max setting limit)

\*\* This function is not applicable for Cooling mode.

Setting temperature for cooling is changed.

New Target Water Temperature = Target Water Temperature + Remote Control setting for cool (\*Capacity 2)

\* (Min/Max regulation of cooling water set apply)

## **14.28 Demand Control (Optional PCB)**

Remote control setting:

- When Optional PCB connection select "YES", Demand Control function can select "YES" or "NO".

Purpose:

- After the demand control select YES, below control will activated.
  - 0-10V Demand control

### 0-10V Demand control

- Demand control is use to reduce the current usage of heat pump unit by third party device.

### Control start condition:

- Select "YES" at Demand control at installer menu.
- 0-10V input for this electrical current control is detected.

### Control content:

- If start condition is fulfilled, indoor will receive the voltage signal from optional PCB. Indoor will send the rate value to outdoor unit.
- Outdoor will change the current limit according to the percentage receive from indoor unit.

## **14.29 Holiday Mode**

- Purpose:  
Promotes energy saving by allowing the user to stop the system during holiday and enables the system to resume at the preset temperature after holiday.
- Control details:
  - Indoor operate the unit according running mode request. Target temperature will follow holiday setting temperature.
    - If heat mode request is receive, Target Water Out Temperature will change according to holiday shift temperature set.  
[If heat is set OFF at holiday, unit, water pump and zone control will OFF]
    - If tank mode request is receive, Target Tank Set Temperature will change according to the holiday tank shift temperature set.  
[If tank is set OFF at holiday, heat pump and tank heater will OFF]
  - After days of holiday have been set, heat pump will stop and only resume operation at the end of holiday countdown.
- Start condition:
  - Holiday timer set and the holiday timer start
    - \* The day holiday mode was set is counted as day 1.
- Stop condition:
  - OFF/ON button is pressed.
  - Holiday timer is reached.

### 14.30 Dry Concrete

- Purpose:
  - Provide heat to floor heating panel and dry the wet concrete during installation.
- Setting condition:
  - Dry concrete parameter can be set through remote control under system setup.
  - Parameters are possible to set up to 99 days with different target set temperature.
- Control details:
  - Dry concrete mode will be activates when select ON from service setup.
  - Once start dry concrete function, remote control will send step 1 setting temperature to indoor unit.
    - \* This temperature is set at zone temperature. If system is 2 zones, both zone target temperature is set as same temperature.
  - Heat pump will start heat mode operation to room side with received target water outlet temperature.
    - \* Heat pump will operate according to Heat pump Target Water Temperature.
  - After complete day 1 setup operation, day 2 data will be send to indoor at 12.00am on the second day.
  - Each preset data will be send every day until dry concrete mode is complete, unit will turns OFF and exit dry concrete function.
  - 3 ways valve and booster heater will turn OFF and 2 ways valve will turns ON.
- Cancel condition:
  - Dry concrete mode is complete and OFF signal is received.
  - OFF signal is received by pressing OFF/ON button.

### 14.31 Flow Sensor

- The water flow sensor serves as an overload protector that shuts down the unit when the water level is detected to below.
- Abnormal flow detection:

Sequence	Abnormal flow	Normal flow
Normal case	Flow rate < 7 l/min or ≥ 69 l/min	≥ 7 l/min
During status 2~6 on Anti-freeze deice	Flow rate ≥ 7 l/min	< 7 l/min

# 15. Protection Control (WH-MDC05J3E5)

## 15.1 Protection Control for All Operations

### 15.1.1 Time Delay Safety Control

- 1 The compressor will not start for three minutes after stop of operation.

### 15.1.2 30 Seconds Forced Operation

- 1 Once the compressor starts operation, it will not stop its operation for 30 seconds.
- 2 However, it can be stopped using control panel at indoor unit.

### 15.1.3 Total Running Current Control

- 1 When the outdoor running current exceeds X value, the compressor frequency will decrease.
- 2 If the outdoor running current does not exceed X value, the compressor frequency will return to normal operating frequency.
- 3 If the outdoor running current continue to increase till exceed Y value, compressor will stop, and if this occurs 3 times within 20 minutes, system will stop operation and OFF/ON control panel LED will blink (F16 error occurs).

WH-MDC05J3E5		
Operation Mode	X (A)	Y (A)
Heating	11.0	14.0
Cooling	8.3	14.0

#### A. DC Peak Current Control

- 1 When the current to IPM exceeds set value, compressor will stop. Compressor will restart after three minutes.
- 2 If the set value exceeds again for more than 30 seconds after the compressor restarts, operation will restart after two minutes.
- 3 If the set value exceeds again for within 30 seconds after the compressor restarts, operation will restart after one minute. If this condition repeats continuously for seven times, system will stop operation and OFF/ON control panel LED will blink (F23 error occurs).

### 15.1.4 Compressor Overheating Prevention Control

- The compressor operating frequency is regulated in accordance to compressor tank temperature as shown in below figures. When the compressor tank temperature exceeds 112°C, compressor will stop, and if this occurs 4 times within 30 minutes, system will stop operation and OFF/ON control panel LED will blink (F20 error occurs).

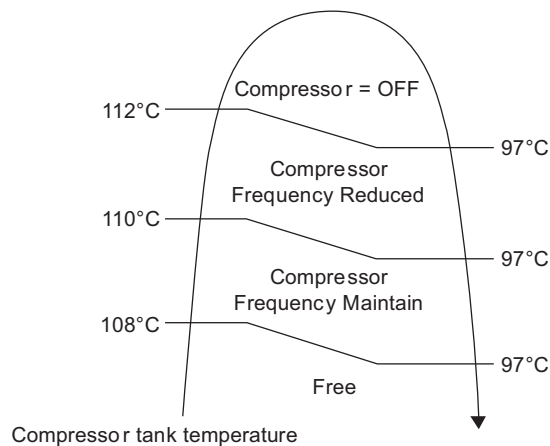

### 15.1.5 High Pressure Sensor Control

- Purpose:
  - To protect the system operation.
- Detection period:
  - After compressor on for 1 minute.
- Detection conditions:
  - When abnormal high voltage detection, 5 V or when open circuit detection 0V for 5 seconds continuously.
- After detection:
  - When abnormality is detected continue 5 seconds, unit stop operation.
  - OFF/ON control panel LED will blink (H64 error occurs).

### 15.1.6 Outside Temperature Current Control

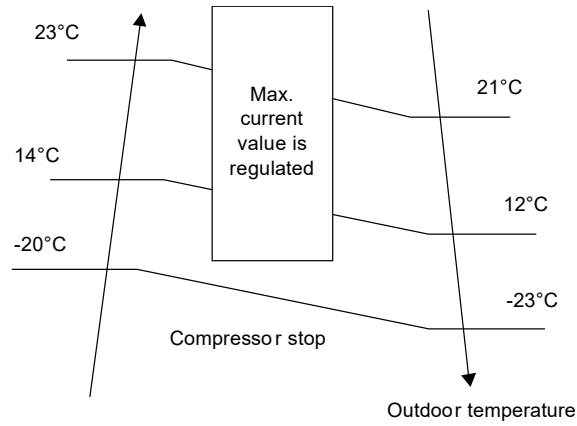

## 15.2 Protection Control for Heating Operation

### 15.2.1 Outdoor Air Temperature Control

The maximum current value is regulated when the outdoor air temperature rises above 14°C in order to avoid compressor overloading.

### 15.2.2 Deice Operation

When outdoor pipe temperature and outdoor air temperature is low, deice operation start where outdoor fan motor stop.

Normally, deice start if pipe sensor temperature fulfil deice condition. If remote controller set to AUTO force defrost setting, unit will start force deice after heat pump operate for 3 hours without deice at below outdoor temperature 5°C.

- Deice judging condition

Outdoor Unit Deice Control

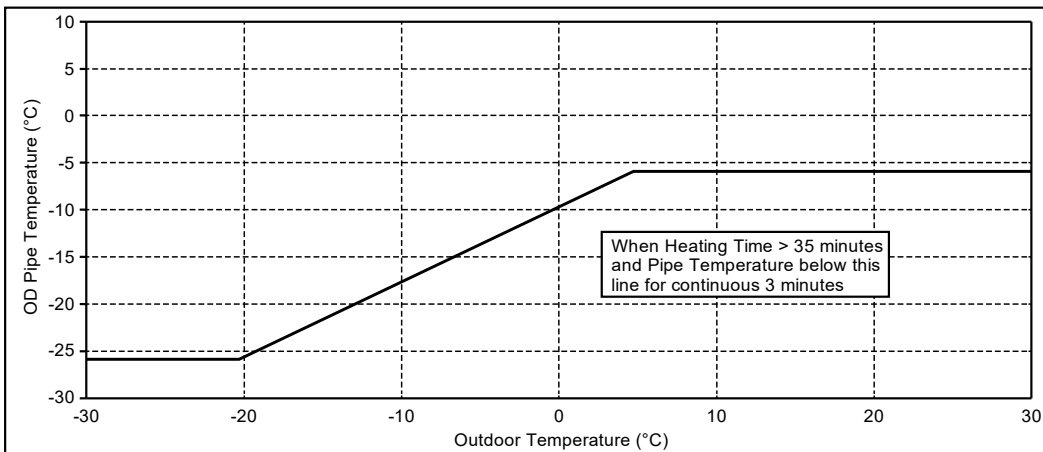

#### Deice start depends:

1. Outdoor air sensor temp.
2. Outdoor pipe sensor temp.
3. Heating accumulation time

Deice operation time diagram

- a. Deice mode 1 control:

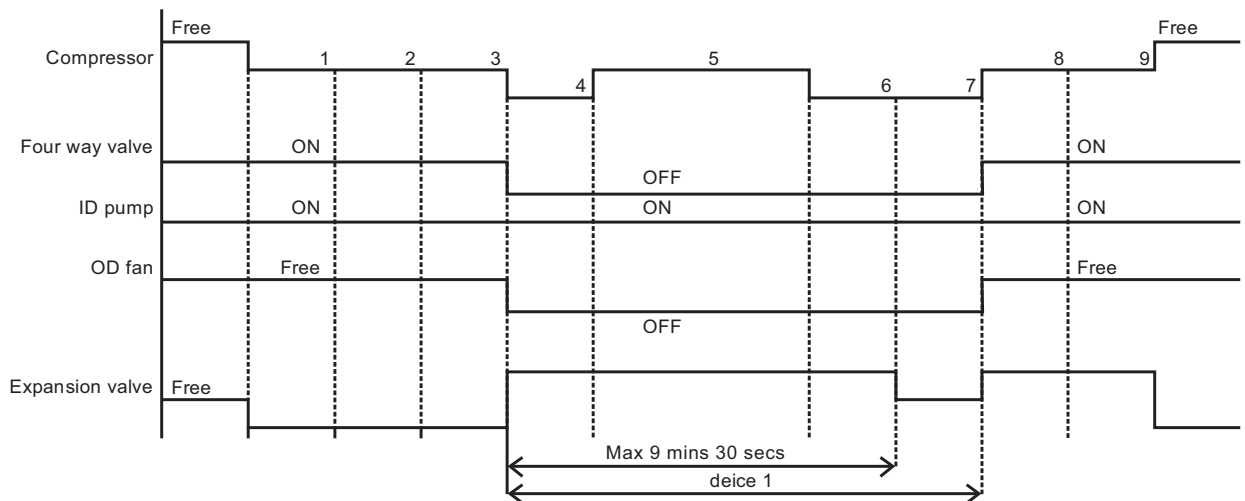

### 15.2.3 Force Defrost Operation

Force defrost can be set through remote control with two selection (Manual OR Auto).

- If Manual defrost set, heat pump only run force defrost at heat mode when force defrost request from quick menu remote control.
- If Auto defrost set, heat pump automatically run force defrost operation after 3 hours heating accumulation time without defrost when ambient below 5°C.

## 15.3 Protection Control for Cooling Operation

### 15.3.1 Outdoor Air Temperature Control

- The Compressor operating frequency is regulated in accordance to the outdoor air temperature as shown in the diagram below.
- This control will begin 1 minute after the compressor starts.
- Compressor frequency will adjust base on outdoor air temperature.

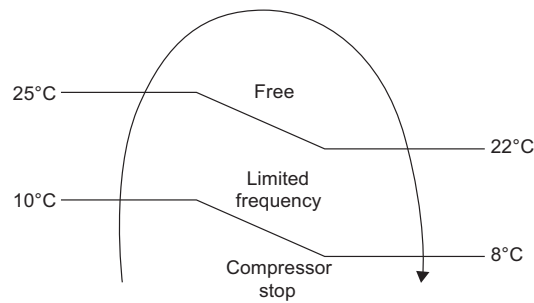

### 15.3.2 Freeze Prevention Control 1

- 1 When indoor heat exchanger temperature is lower than 0°C continuously for 10 seconds, compressor will stop operating.
- 2 Compressor will resume its operation three minutes after the indoor heat exchanger is higher than 1°C.
- 3 Indoor heat exchanger freeze prevention (H99) will memory in error history.



## 16. Protection Control (WH-MDC07J3E5 WH-MDC09J3E5)

### 16.1 Protection Control for All Operations

#### 16.1.1 Time Delay Safety Control

- 1 The compressor will not start for three minutes after stop of operation.

#### 16.1.2 30 Seconds Forced Operation

- 1 Once the compressor starts operation, it will not stop its operation for 30 seconds.
- 2 However, it can be stopped using control panel at indoor unit.

#### 16.1.3 Total Running Current Control

- 1 When the outdoor running current exceeds X value, the compressor frequency will decrease.
- 2 If the outdoor running current does not exceed X value, the compressor frequency will return to normal operating frequency.
- 3 If the outdoor running current continue to increase till exceed Y value, compressor will stop, and if this occurs 3 times within 20 minutes, system will stop operation and OFF/ON control panel LED will blink (F16 error occurs).

Operation Mode	WH-MDC07J3E5		WH-MDC09J3E5	
	X (A)	Y (A)	X (A)	Y (A)
Heating	15.0	17.0	15.0	17.0
Cooling	12.2	17.0	12.2	17.0

#### A. DC Peak Current Control

- 1 When the current to IPM exceeds set value, compressor will stop. Compressor will restart after three minutes.
- 2 If the set value exceeds again for more than 30 seconds after the compressor restarts, operation will restart after two minutes.
- 3 If the set value exceeds again for within 30 seconds after the compressor restarts, operation will restart after one minute. If this condition repeats continuously for seven times, system will stop operation and OFF/ON control panel LED will blink (F23 error occurs).

#### 16.1.4 Compressor Overheating Prevention Control

- The compressor operating frequency is regulated in accordance to compressor tank temperature as shown in below figures. When the compressor tank temperature exceeds 112°C, compressor will stop, and if this occurs 4 times within 30 minutes, system will stop operation and OFF/ON control panel LED will blink (F20 error occurs).

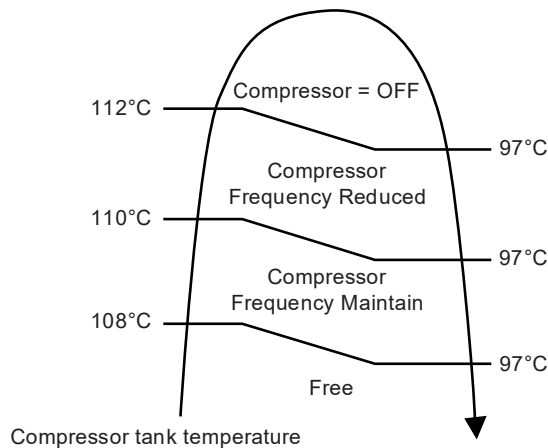

### 16.1.5 High Pressure Sensor Control

- Purpose:
  - To protect the system operation.
- Detection period:
  - After compressor on for 1 minute.
- Detection conditions:
  - When abnormal high voltage detection, 5 V or when open circuit detection 0V for 5 seconds continuously.
- After detection:
  - When abnormality is detected 4 times within 120 minutes, unit stop operation.
  - OFF/ON control panel LED will blink (H64 error occurs).

### 16.1.6 Outside Temperature Current Control

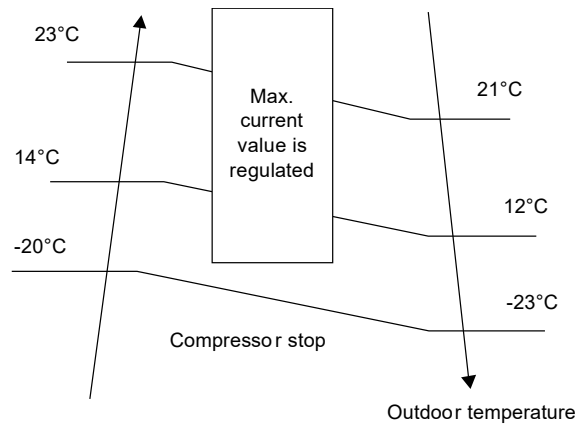

## 16.2 Protection Control for Heating Operation

### 16.2.1 Outdoor Air Temperature Control

The maximum current value is regulated when the outdoor air temperature rises above 14°C in order to avoid compressor overloading.

### 16.2.2 Deice Operation

When outdoor pipe temperature and outdoor air temperature is low, deice operation start where outdoor fan motor stop.

Normally, deice start if pipe sensor temperature fulfil deice condition. If remote controller set to AUTO force defrost setting, unit will start force deice after heat pump operate for 3 hours without deice at below outdoor temperature 5°C.

- Deice judging condition

Outdoor Unit Deice Control

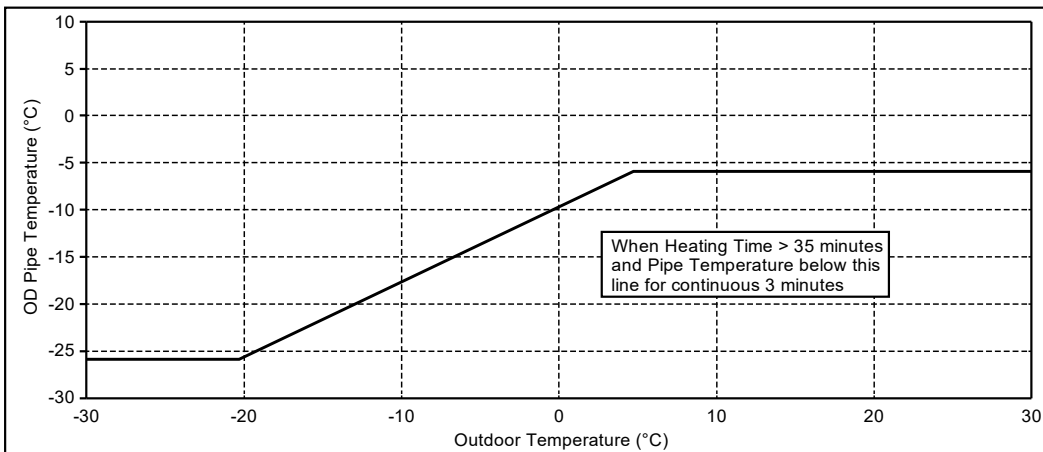

**Deice start depends:**

1. Outdoor air sensor temp.
2. Outdoor pipe sensor temp.
3. Heating accumulation time

Deice operation time diagram

b. Deice mode 1 control:

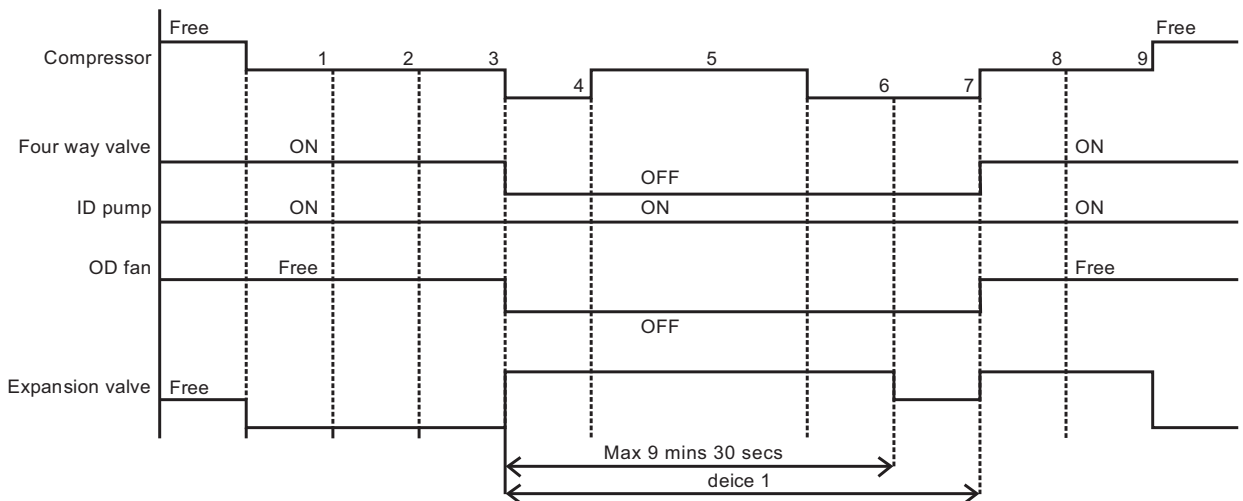

### 16.2.3 Force Defrost Operation

Force defrost can be set through remote control with two selection (Manual OR Auto).

- If Manual defrost set, heat pump only run force defrost at heat mode when force defrost request from quick menu remote control.
- If Auto defrost set, heat pump automatically run force defrost operation after 3 hours heating accumulation time without defrost when ambient below 5°C.

## 16.3 Protection Control for Cooling Operation

### 16.3.1 Outdoor Air Temperature Control

- The Compressor operating frequency is regulated in accordance to the outdoor air temperature as shown in the diagram below.
- This control will begin 1 minute after the compressor starts.
- Compressor frequency will adjust base on outdoor air temperature.

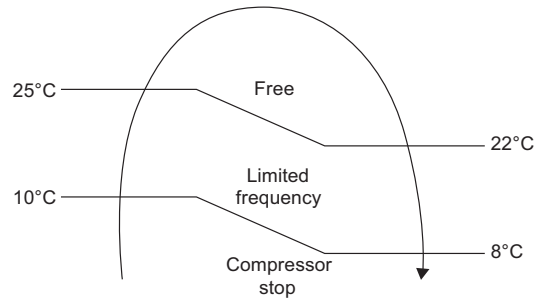

### 16.3.2 Freeze Prevention Control 1

- 1 When indoor heat exchanger temperature is lower than 0°C continuously for 10 seconds, compressor will stop operating.
- 2 Compressor will resume its operation three minutes after the indoor heat exchanger is higher than 1°C.
- 3 Indoor heat exchanger freeze prevention (H99) will memory in error history.

# 17. Servicing Mode

## 17.1 Expansion Vessel Pre Pressure Checking

[Upper limit water volume of the system]

The Mono bloc unit has a build-in Expansion Vessel with 6 L air capacity and initial pressure of 1 bar.

- Without antifreeze agent condition

Total amount of water in the system should be below 150 L.

If the total amount of water is more than 150 L, please add expansion vessel (field supply).

- With antifreeze agent condition

In the case of using antifreeze agent, expansion rate  $\epsilon$  is different depending on its maker.

Please refer to the antifreeze agent maker for the expansion rate  $\epsilon$  before calculate the upper limit water volume of the system.

The expansion vessel capacity required for the system can be calculated from the formula below.

$$V = \frac{\epsilon \times V_0}{1 - \frac{98 + P_1}{98 + P_2}}$$

V : Required gas volume <expansion vessel volume L>

V<sub>0</sub> : System total water volume <L>

$\epsilon$  : Expansion rate 5 → 60°C = (depends on antifreeze agent used)

P<sub>1</sub> : Expansion tank filling pressure = (100) kPa

P<sub>2</sub> : System maximum pressure = 300 kPa

- ( ) Please confirm at actual place

- The gas volume of the sealed type expansion vessel is presented by <V>.

- It's advised to add 10% margin for required gas volume of calculation.

Water expansion rate table

Water temperature (°C)	Water expansion rate $\epsilon$
10	0.0003
20	0.0019
30	0.0044
40	0.0078
50	0.0121
60	0.0171
70	0.0228
80	0.0291
90	0.0360

[Adjustment of the initial pressure of the expansion vessel when there is a difference in installation height]

If the height difference between the Mono bloc unit and the highest point of the system water circuit (H) is more than 7m, please adjust the initial pressure of the expansion vessel (Pg) according to the following formula.

$$P_g = (H \times 10 + 30) \text{ kPa}$$

## 17.2 Maintenance

- In order to ensure optimal performance of the unit, seasonal inspections on the unit, functional check of RCCB, field wiring and piping have to be carried out at regular intervals. This maintenance should be carried out by authorized dealer.

### 17.2.1 Maintenance for Water Filter Set

1. Remove the Cover by loosening the mounting screws to access to the Water Filter Set.
2. Turn OFF power supply.
3. Set the two valves for the Water Filter Set to "CLOSE".
4. Take off the clip, then gently pull out the mesh. Beware of small amount water drain out from it.
5. Clean the mesh with warm water to remove all the stain. Use soft brush if necessary.

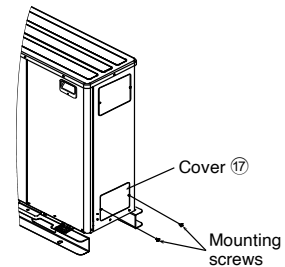

6. Reinstall the mesh to the Water Filter Set and set back the clip on it.
7. Set the two valves for the Water Filter Set to "OPEN".
8. Turn ON power supply.
9. After cleaning, reinstall the Cover by tightening the mounting screws properly.

#### WARNING

Do not add or replace other than R410A type. It may cause product damage, burst, injury and etc. Use compatible R410A tools for refrigerant piping work and refrigerant charging during installation or servicing.

### 17.3 Pump Down Procedures

Refer below steps for proper pump down procedure.

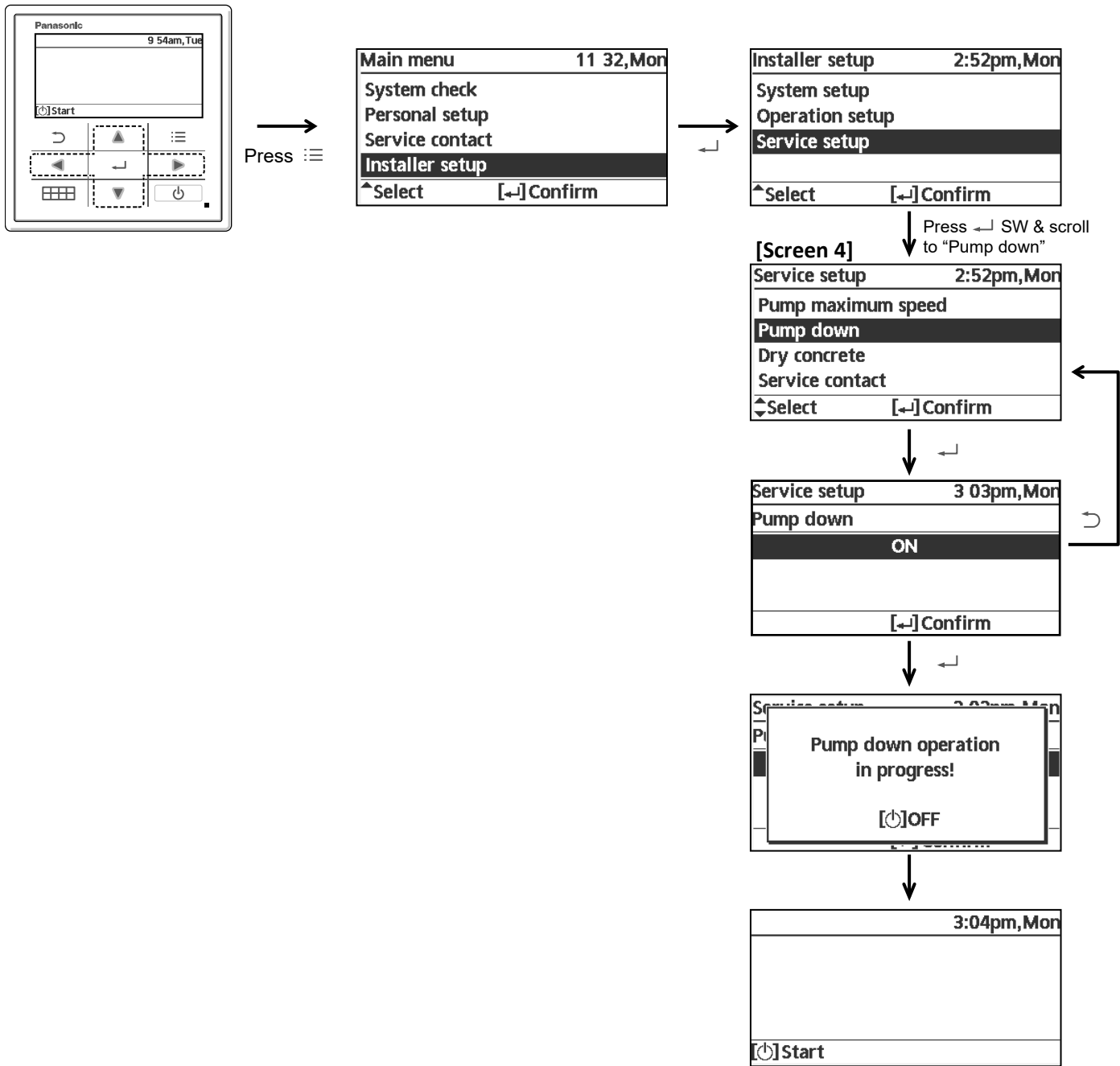

## 17.4 How To Adjust Pump Speed

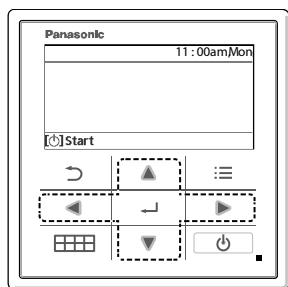

Press & scroll to "Installer setup"

Main menu		11 32, Mon
System check		
Personal setup		
Service contact		
<b>Installer setup</b>		
▲ Select		[←] Confirm

Installer setup		2:52pm, Mon
System setup		
Operation setup		
<b>Service setup</b>		
▲ Select		[←] Confirm

[Screen 4] Service setup		2:53pm, Mon
<b>Pump maximum speed</b>		
Pump down		
Dry concrete		
Service contact		
▼ Select		[←] Confirm

- Press ▲ or ▼ SW to select & confirm maximum duty. (Range: 0x40~0xFF)

[Screen 5]

Service setup		12:16pm, Mon
Flow rate	Max. Duty	Operation
88.8 L/min	<b>0x40</b>	OFF
▲ Select		

Service setup		12:09pm, Mon
Flow rate	Max. Duty	Operation
88.8 L/min	<b>0xCE</b>	OFF
↕ Select		

Service setup		12 10pm, Mon
Flow rate	Max. Duty	Operation
88.8 L/min	<b>0xFE</b>	OFF
▼ Select		

- Range (0.1~99.9)L/min

[Screen 6]

Service setup		12 15pm, Mon
Flow rate	Max. Duty	Operation
88.8 L/min	0xCE	<b>OFF</b>
↙ Select		

Service setup		12 11pm, Mon
Flow rate	Max. Duty	Operation
88.8 L/min	0xCE	<b>ON</b>
↙ Select		

Service setup		12:15pm, Mon
Flow rate	Max. Duty	Operation
88.8 L/min	0xCE	<b>Air Purge</b>
↙ Select		

Press ▲ or ▼ SW to select & confirm operation

## 17.5 How To Adjust Pump Speed

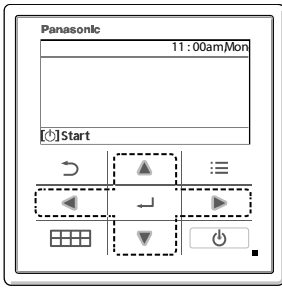

Press & scroll to "Installer setup"

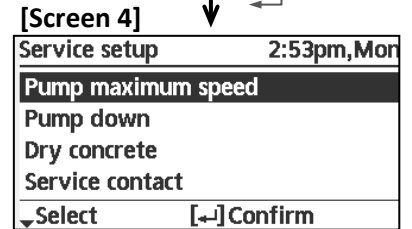
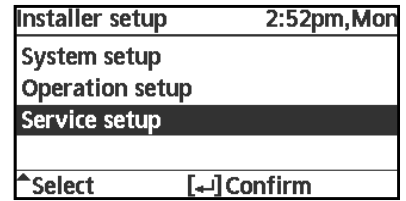
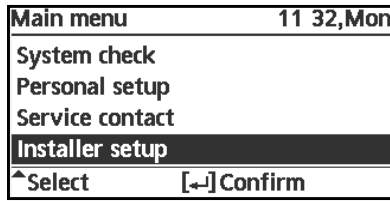

- Press or SW to select & confirm maximum duty. (Range: 0x40~0xFF)

[Screen 5]

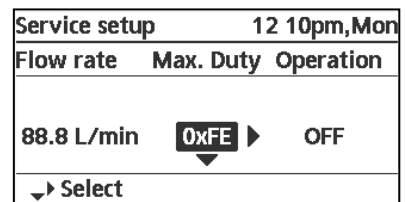
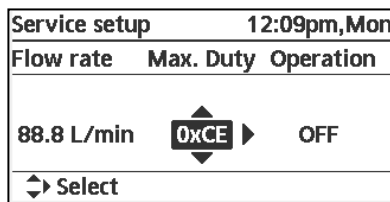
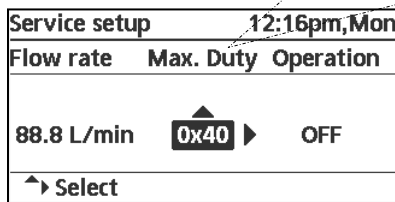

- Range (0.1~99.9)L/min

[Screen 6]

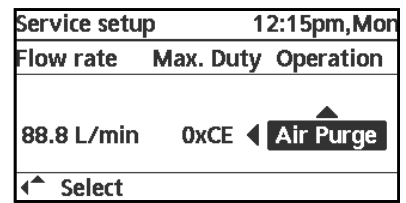
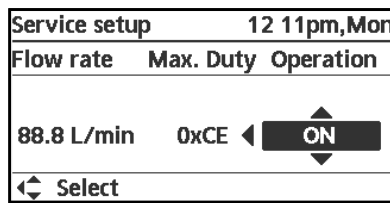
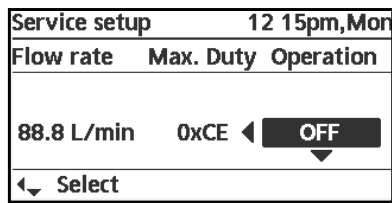

Press or SW to select & confirm operation

### NOTE:

1. Whenever at [Screen 5], if press SW to OFF, pump operation should be turned OFF.
2. Whenever at [Screen 6], if press SW to OFF, pump operation should be turned OFF.



## 17.6 How To Unlock Cool Mode

Operation must be OFF

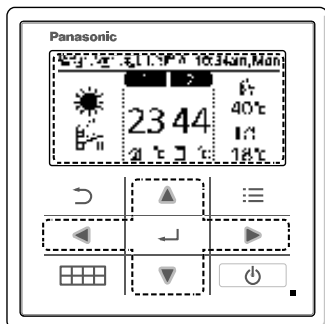

Press (☰ + ▼ + ◀) SW's continuously for 5secs

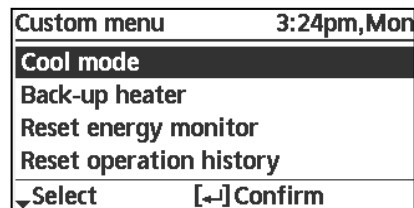
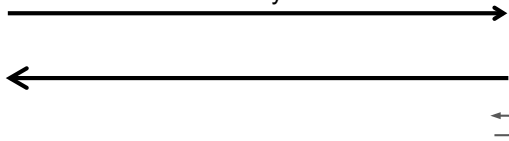

Display latest status retrieved from EEPROM

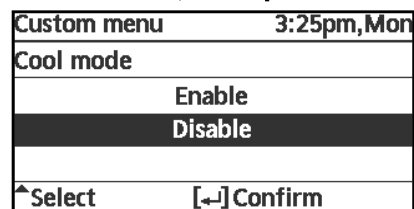
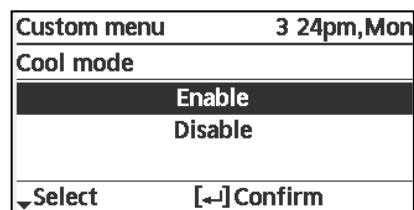

## 17.7 EEPROM Factory Default Data Setup Procedure

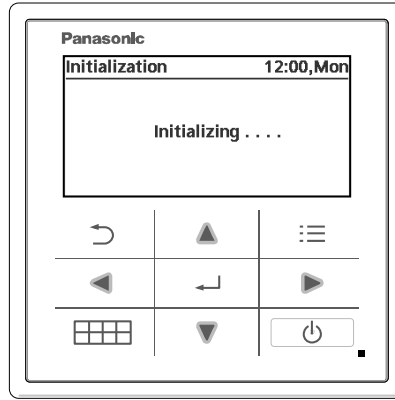

- EEPROM default data setup is only possible during initialization process.
- Press ( ▲ , ▼ , ◀ , ▶ )simultaneously for 5secs continuously, initialization process will stop & EEPROM default data setup process will start.

During EEPROM default data setup process, display should be as shown below.

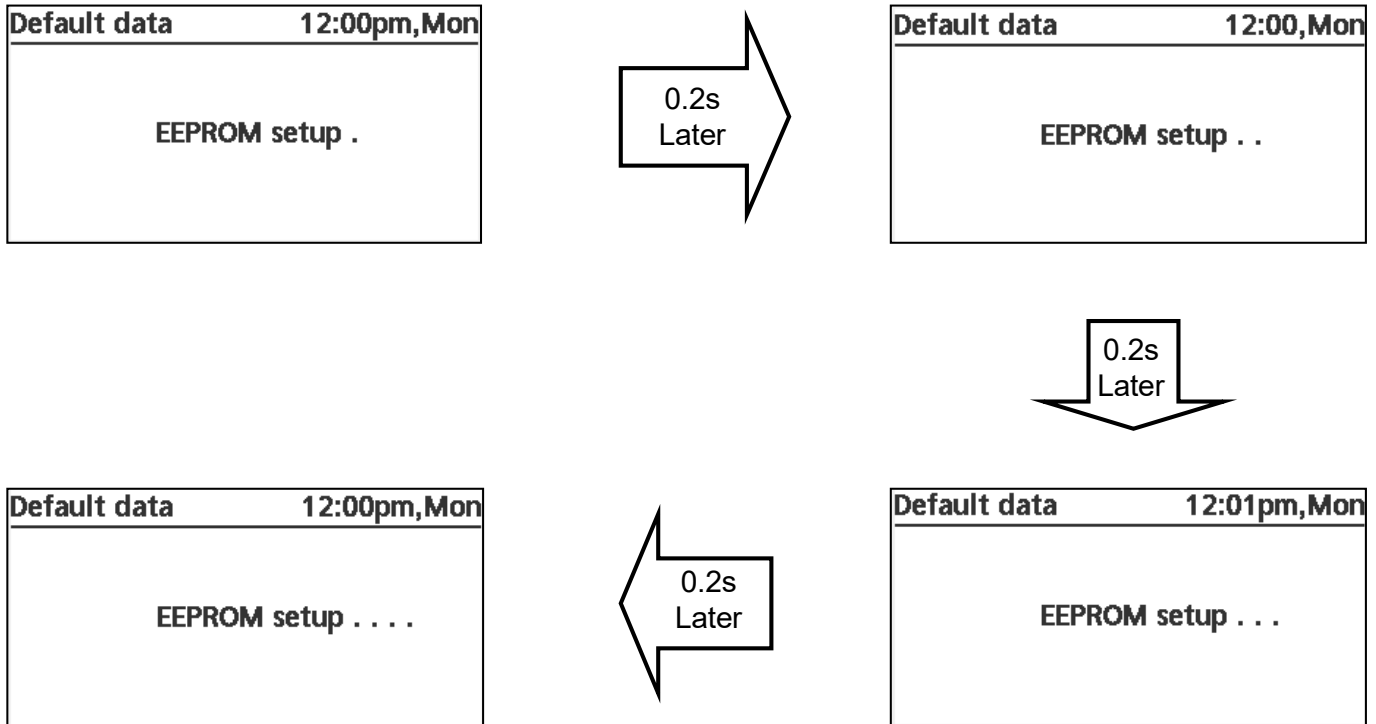

- Once EEPROM default data setup process is complete, initialization process will re-start from beginning.

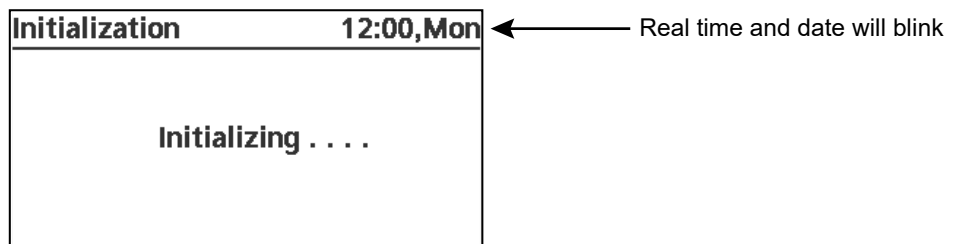

# 17.8 Dry Concrete Setup

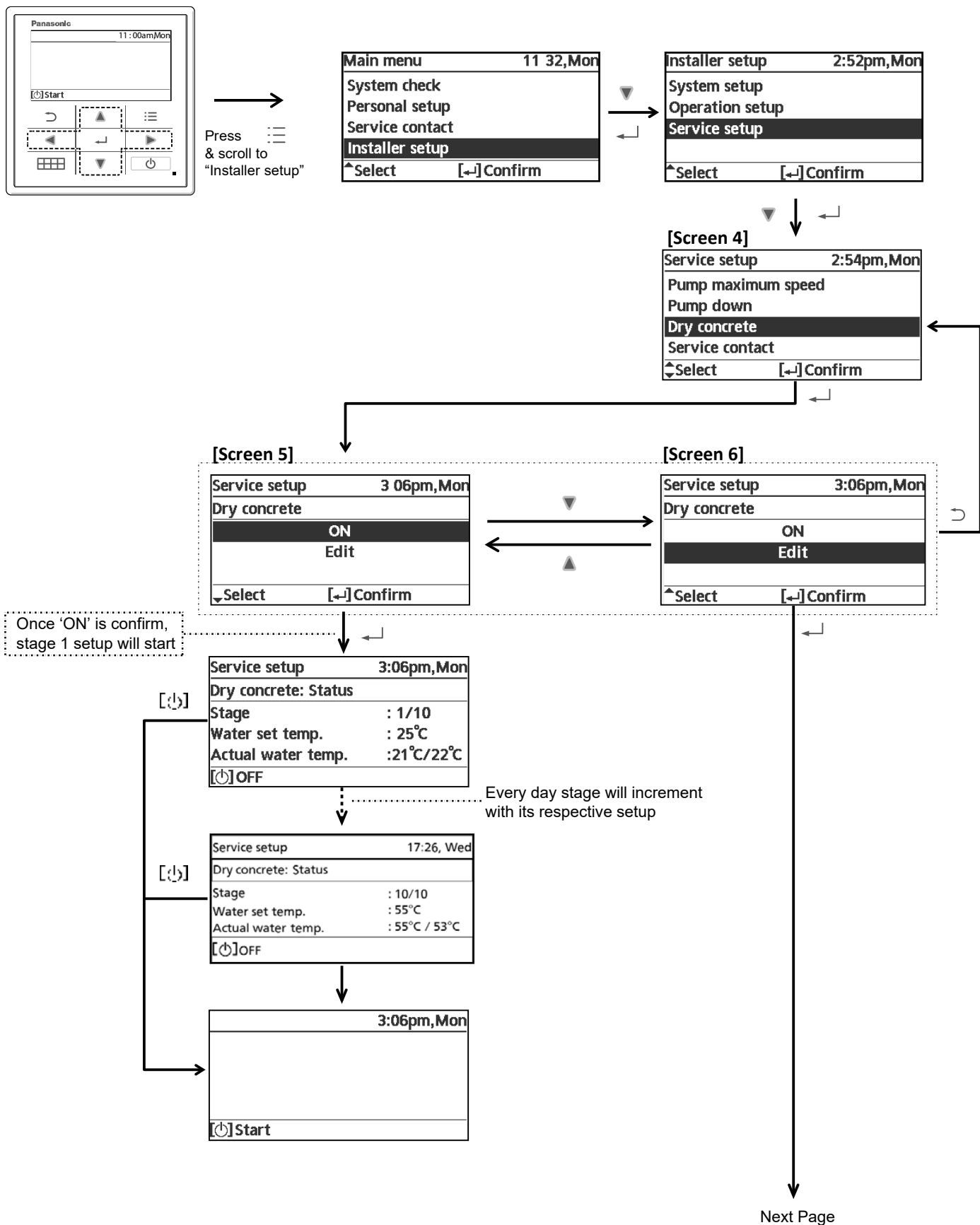

- Press ▲ or ▼ button to select no. of stages.  
 - Press ↵ to store latest status.  
 - Press ↶ button, display will return to [Screen 6].

- If suppose to select 10 stages, then setup will start from stage 1/10.  
 - Press ▲ or ▼ button to select set temperature.  
 - Press ↵ button to store latest status.

- Move to next stage 2/10  
 - Repeat the same procedure

- Move to next stage 10/10  
 - Repeat the same procedure.  
 - Press ↵ to store latest status the the display will return to [Screen 4]  
 - Press ↶ button to return to stage 9/10.

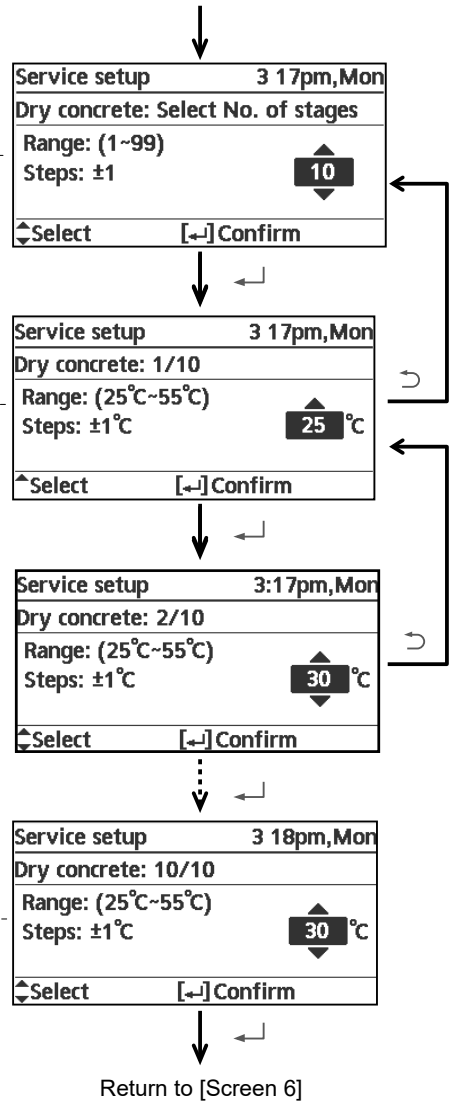

## 18. Maintenance Guide

In order to ensure safety and optimal performance of the unit, seasonal inspections on the unit, functional check of RCCB/ELCB, field wiring and piping have to be carried out at regular intervals. This maintenance should be carried out by authorized dealer. Contact dealer for scheduled inspection.

### 1 Water pressure

Water pressure should not lower than 0.05 MPa (with inspects the Water Pressure Gauge). If necessary add tap water into Tank Unit. Refer to Tank unit installation instruction for details on how to add water.

### 2 Pressure relief valve

- Check for correct operation of Pressure Relief Valve by turning on the lever to become horizontal.
- If you do not hear a clacking sound (due to water drainage), contact your local authorized dealer.
- Push down the lever after finish checking.
- In case the water keeps drained out from the unit, switch off the system, and then contact your local authorized dealer.

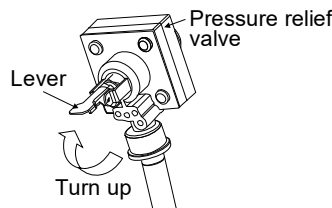

Pressure relief valve

### 3 Air purge valve

Air purge valve must be installed at all high points in a closed water circuit system.

An automatic air purge valve is provided inside the indoor unit. To automatically purge the air from the system, turn the plug on the air outlet anticlockwise by one complete turn from fully closed position. Excessive air is automatically purged if the plug is kept in this position.

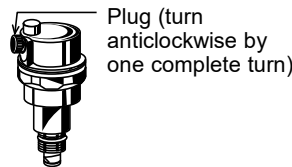

Air purge valve

### 4 Indoor unit control board area

Thorough visual inspection of the control board and look for defects, i.e. loose connection, melting of wire insulator and etc.

### 5 RCCB/ELCB

Ensure the RCCB/ELCB set to "ON" condition before check RCCB/ELCB.

Turn on the power supply to the Indoor Unit.

This testing could only be done when power is supplied to the Indoor Unit.



#### WARNING

Be careful not to touch parts other than RCCB/ELCB test button when the power is supplied to Indoor Unit. Else, electrical shock may happen.

- Push the "TEST" button on the RCCB/ELCB. The lever would turn down and indicate "0", if it functions normal.
- Contact authorized dealer if the RCCB/ELCB malfunction.
- Turn off the power supply to the Indoor Unit.
- If RCCB/ELCB functions normal, set the lever to "ON" again after testing finish.

## 6 Reset overload protector

Overload Protector serves the safety purpose to prevent the water over heating. When the Overload Protector trips at high water temperature, take below steps to reset it.

- a. Take out the cover.
- b. Use a test pen to push the centre button gently in order to reset the Overload Protector.
- c. Fix the cover to the original fixing condition.

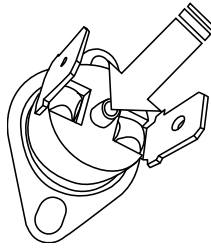

Use test pen to push this button for reset Overload protector.

## 18.1 Maintenance Menu

### 18.1.1 Service and maintenance

#### When connect CN-CNT connector with computer

Please use optional USB cable to connect with CN-CNT connector.  
After connected, it requests for driver. If PC is under Windows Vista or later version, it automatically installs the driver under internet environment.

If PC uses Windows XP or earlier version and there is no internet access, please get FTDI Ltd's USB - RS232C conversion IC driver (VCP driver) and install.  
<http://www.ftdichip.com/Drivers/VCP.htm>

#### If forget Password and cannot operate remote controller

Press  $\leftarrow + \leftarrow + \rightarrow$  for 5 sec.  
Password unlock screen appears, press Confirm and it shall reset.  
Password will become 0000. Please reset it again.  
(CAUTION) Only display when it is locked by password.

### 18.1.2 Maintenance menu

#### Setting method of Maintenance menu

Maintenance menu	17:26, Wed
<b>Actuator check</b>	
Test mode	
Sensor setup	
Reset password	
▼ Select	[↵] Confirm

Press  $\leftarrow + \leftarrow + \rightarrow$  for 5 sec.

Items that can be set

- ① Actuator check (Manual ON/OFF all functional parts)  
(CAUTION) As there is no protection action, please be careful not to cause any error when operating each part (do not turn on pump when there is no water etc.)
- ② Test mode (Test run)  
Normally it is not used.
- ③ Sensor setup (offset gap of detected temp of each sensor within  $-2\sim 2^{\circ}\text{C}$  range)  
(CAUTION) Please use only when sensor is deviated.  
It affects temperature control.
- ④ Reset password (Reset password)

### 18.1.3 Custom menu

**Setting method of Custom menu**

Custom menu 17:26, Wed  
**Cool mode**  
 Back-up heater  
 Reset energy monitor

▼ Select      [↵] Confirm

Please press  + ▼ + ◀ for 10 sec.

Items that can be set

① Cool mode (Set With/Without Cooling function) Default is without  
 (CAUTION) As with/without Cool mode may affect electricity application, please be careful and do not simply change it.  
 In Cool mode, please be careful if piping is not insulated properly, dew may form on pipe and water may drip on the floor and damage the floor.

② Backup heater (Use/Do not use Backup heater)  
 (CAUTION) It is different from to use/not to use backup heater set by client. When this setting is used, heater power on due to protection against frost will be disabled. (Please use this setting when it is required by utility company.)  
 By using this setting, it cannot defrost due to low Heating's setting temp and operation may stop (H75)  
 Please set under the responsibility of installer.  
 When it stops frequently, it may be due to insufficient circulation flow rate, setting temp of heating is too low etc.

③ Reset energy monitor (delete memory of Energy monitor)  
 Please use when moving house and handover the unit.

### 18.1.4 Specifications

#### 18.1.4.1 Specifications of fresh water as heat transfer medium in brazed heat exchanger

Parameter	Quality Limits for Tap Water on the Secondary Side
Temperature	Below 60°C
pH	7 to 9
Alkalinity	60mg/l <HCO <sub>3</sub> <300mg/l
Conductivity	< 500µS/cm
Hardness	[Ca <sup>+</sup> , Mg <sup>+</sup> ] / [HCO <sub>3</sub> ] > 5
Chloride	< 200mg/l at 60°C
Sulphate	[SO <sub>4</sub> <sup>2-</sup> ] > 100mg/l and [HCO <sub>3</sub> ] / [SO <sub>4</sub> <sup>2-</sup> ] > 1
Nitrate	NO <sub>3</sub> < 100mg/l
Chlorine	< 0.5mg/l

#### 18.1.4.2 External filter

Solids in the water must be filtered.

Minimum filter mesh size required for the field supply external filter in the water inlet is 20 mesh.

# 19. Troubleshooting Guide

## 19.1 Refrigeration Cycle System

In order to diagnose malfunctions, make sure that there are no electrical problems before inspecting the refrigeration cycle.

Such problems include insufficient insulation, problem with the power source, malfunction of a compressor and a fan.

The normal pressure of the refrigeration cycle depends on various conditions, the standard values for them are shown in the table on the right.

Normal Pressure (Standard)

	Gas pressure MPa (kg/cm <sup>2</sup> G)
Heating Mode	2.3 ~ 2.9 (23 ~ 29)
Cooling Mode	0.9 ~ 1.2 (9 ~ 12)

- ★ Condition:
- Outdoor temperature 7°C at heating mode and 35°C at cooling mode.
  - Compressor operates at rated frequency.

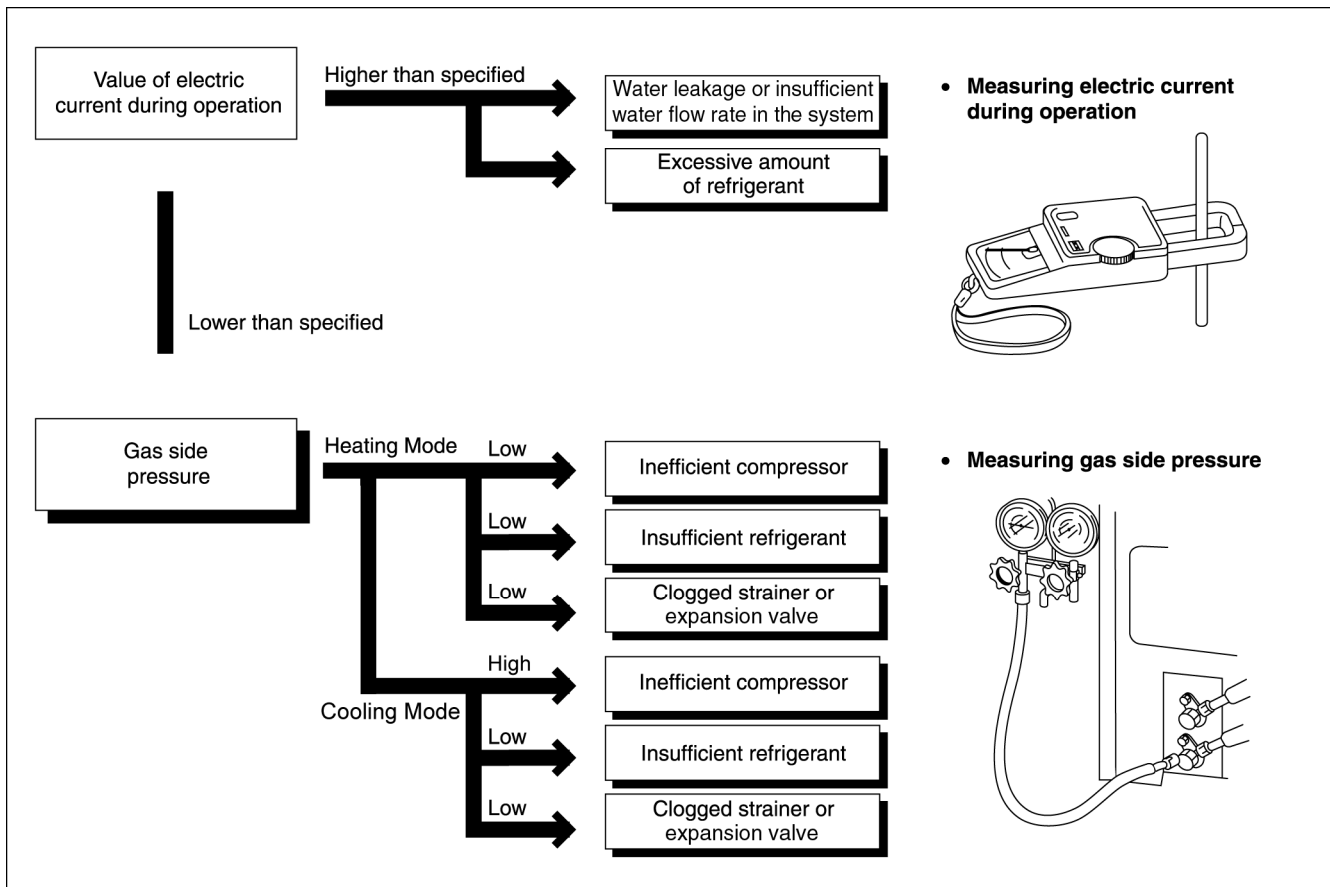



## 19.2 Relationship between the Condition of the Air-to-Water Heatpump Indoor and Outdoor Units and Pressure and Electric Current

Condition of the Air-to-Water Heatpump indoor and outdoor units	Heating Mode			Cooling Mode		
	Low Pressure	High Pressure	Electric current during operation	Low Pressure	High Pressure	Electric current during operation
Water leakage or insufficient water flow rate in the system						
Excessive amount of refrigerant						
Inefficient compression						
Insufficient refrigerant (gas leakage)						
Outdoor heat exchange deficiency						
Clogged expansion valve or Strainer						

- Carry out the measurements of pressure, electric current, and temperature fifteen minutes after an operation is started.

## 19.3 Breakdown Self Diagnosis Function

### 19.3.1 Self Diagnosis Function (Three Digits Alphanumeric Code)

- When abnormality occur during operation, the system will stop operation, and OFF/ON control panel LED will blink and error code will display on the control panel.
- Even error code is reset by turning OFF power supply or by selecting ERROR RESET, if the system abnormality is still unrepaired, system will again stop operation, and OFF/ON control panel LED will again blinks and error code will be display.
- The error code will store in IC memory.
- **To check the error code**
  - When an abnormality occurs, system will stop operation and OFF/ON control panel LED will blink.
  - Error code of the abnormality will be display on the control panel.
  - To determine the abnormality description, the error code table needs to be referred.

eg:

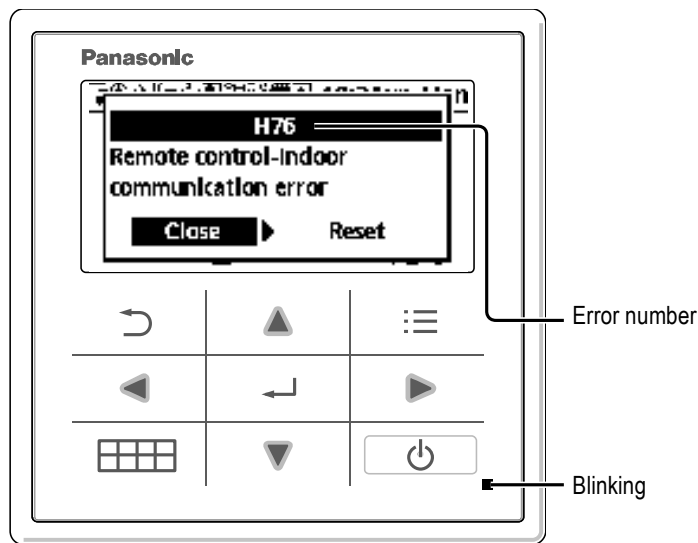

Press ◀▶ to select Close / Reset then press ↵

- **To display past/last error code**
  - Turn ON power supply.
  - Refer below procedure to retrieve the error code history.
- **To permanently delete error code from IC memory**
  - Turn ON power supply.
  - Refer below procedure to clear error history.

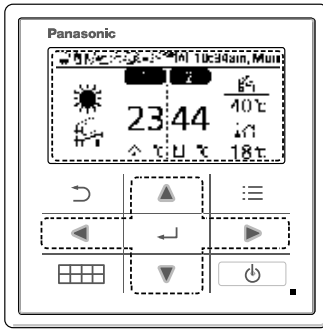

Main menu 9:17am, Mon	
Function setup	
<b>System check</b>	
Personal setup	
Service contact	
↔Select	[←] Confirm

System check 9:34am, Mon	
<b>Energy monitor</b>	
Water temperatures	
Error history	
Compressor	
↔Select	[←] Confirm

Press SW to select "Error history"

[Screen 4] System check 9 43am, Mon	
Energy monitor	
Water temperatures	
<b>Error history</b>	
Compressor	
↔Select	[←] Confirm

Display last 4 error retrieved from EEPROM

Error history 8 23am, Mon	
1. H76 (2015/05/18)	
2. H15 (2015/05/18)	
3. H70 (2015/05/18)	
4. H76 (2015/05/18)	
[←] Clear history	

Do you want to clear error history?	
1	
2	
3	
4	
Yes	<b>No</b>

Do you want to clear error history?	
1	
2	
3	
4	
<b>Yes</b>	No

Error history 9 41am, Mon	
1. --	
2. --	
3. --	
4. --	
[←] Clear history	

## 19.4 Error Codes Table

Diagnosis display	Abnormality/Protection control	Abnormality judgement	Primary location to verify
H00	No abnormality detected	—	—
H12	Indoor/Outdoor capacity unmatched	90s after power supply	<ul style="list-style-type: none"> <li>Indoor/outdoor connection wire</li> <li>Indoor/outdoor PCB</li> <li>Specification and combination table in catalogue</li> </ul>
H15	Outdoor compressor temperature sensor abnormality	Continue for 5 sec.	<ul style="list-style-type: none"> <li>Compressor temperature sensor (defective or disconnected)</li> </ul>
H20	Water pump abnormality	Continue for 10 sec.	<ul style="list-style-type: none"> <li>Indoor PCB</li> <li>Water pump (malfunction)</li> </ul>
H23	Indoor refrigerant liquid temperature sensor abnormality	Continue for 5 sec.	<ul style="list-style-type: none"> <li>Refrigerant liquid temperature sensor (defective or disconnected)</li> </ul>
H27	Service valve error	Continue for 5 minutes	<ul style="list-style-type: none"> <li>High pressure sensor (defective or disconnected)</li> </ul>
H28	Abnormal solar sensor	Continue for 5 sec.	<ul style="list-style-type: none"> <li>Solar temperature sensor (defective or disconnected)</li> </ul>
H31	Abnormal swimming pool sensor	Continue for 5 sec.	<ul style="list-style-type: none"> <li>Pool temperature sensor (defective or disconnected)</li> </ul>
H36	Abnormal buffer tank sensor	Continue for 5 sec.	<ul style="list-style-type: none"> <li>Buffer tank sensor (defective or disconnected)</li> </ul>
H38	Brand code not match	When indoor and outdoor brand code not same	—
H42	Compressor low pressure abnormality	—	<ul style="list-style-type: none"> <li>Outdoor pipe temperature sensor</li> <li>Clogged expansion valve or strainer</li> <li>Insufficient refrigerant</li> <li>Outdoor PCB</li> <li>Compressor</li> </ul>
H43	Abnormal Zone 1 sensor	Continue for 5 sec.	<ul style="list-style-type: none"> <li>Water temperature Zone 1 sensor</li> </ul>
H44	Abnormal Zone 2 sensor	Continue for 5 sec.	<ul style="list-style-type: none"> <li>Water temperature Zone 2 sensor</li> </ul>
H62	Water flow switch abnormality	Continue for 1 min.	<ul style="list-style-type: none"> <li>Water flow switch</li> </ul>
H63	Abnormal low pressure sensor	4 times in 20 minutes	<ul style="list-style-type: none"> <li>Low pressure sensor (defective or disconnect)</li> </ul>
H64	Refrigerant high pressure abnormality	Continue for 5 sec.	<ul style="list-style-type: none"> <li>Outdoor high pressure sensor (defective or disconnected)</li> </ul>
H65	Abnormal deice water circulation	water flow > 7 l/min continuously for 20 second during anti freeze deice	<ul style="list-style-type: none"> <li>Water pump</li> </ul>
H67	Abnormal External Thermistor 1	Continue for 5 sec.	<ul style="list-style-type: none"> <li>Room temperature Zone 1 sensor</li> </ul>
H68	Abnormal External Thermistor 2	Continue for 5 sec.	<ul style="list-style-type: none"> <li>Room temperature Zone 2 sensor</li> </ul>
H70	Back-up heater OLP abnormality	Continue for 60 sec.	<ul style="list-style-type: none"> <li>Back-up heater OLP (Disconnection or activated)</li> </ul>
H72	Tank sensor abnormal	Continue for 5 sec.	<ul style="list-style-type: none"> <li>Tank sensor</li> </ul>
H74	PCB communication error	Communication or transfer error	<ul style="list-style-type: none"> <li>Indoor main PCB and Sub PCB</li> </ul>
H75	Low water temperature control	Room heater disable and deice request to operate under low water temperature	<ul style="list-style-type: none"> <li>Heater operation must enable to increase water temperature</li> </ul>
H76	Indoor - control panel communication abnormality	—	<ul style="list-style-type: none"> <li>Indoor - control panel (defective or disconnected)</li> </ul>
H90	Indoor/outdoor abnormal communication	> 1 min after starting operation	<ul style="list-style-type: none"> <li>Internal/external cable connections</li> <li>Indoor/Outdoor PCB</li> </ul>
H91	Tank heater OLP abnormality	Continue for 60 sec.	<ul style="list-style-type: none"> <li>Tank heater OLP (Disconnection or activated)</li> </ul>
H95	Indoor/Outdoor wrong connection	—	<ul style="list-style-type: none"> <li>Indoor/Outdoor supply voltage</li> </ul>
H98	Outdoor high pressure overload protection	—	<ul style="list-style-type: none"> <li>Outdoor high pressure sensor</li> <li>Water pump or water leakage</li> <li>Clogged expansion valve or strainer</li> <li>Excess refrigerant</li> <li>Outdoor PCB</li> </ul>
H99	Indoor heat exchanger freeze prevention	—	<ul style="list-style-type: none"> <li>Indoor heat exchanger</li> <li>Refrigerant shortage</li> </ul>
F12	Pressure switch activate	4 times occurrence within 20 minutes	<ul style="list-style-type: none"> <li>Pressure switch</li> </ul>
F14	Outdoor compressor abnormal revolution	4 times occurrence within 20 minutes	<ul style="list-style-type: none"> <li>Outdoor compressor</li> </ul>
F15	Outdoor fan motor lock abnormality	2 times occurrence within 30 minutes	<ul style="list-style-type: none"> <li>Outdoor PCB</li> <li>Outdoor fan motor</li> </ul>
F16	Total running current protection	3 times occurrence within 20 minutes	<ul style="list-style-type: none"> <li>Excess refrigerant</li> <li>Outdoor PCB</li> </ul>

Diagnosis display	Abnormality/Protection control	Abnormality judgement	Primary location to verify
F20	Outdoor compressor overheating protection	4 times occurrence within 30 minutes	<ul style="list-style-type: none"> <li>Compressor tank temperature sensor</li> <li>Clogged expansion valve or strainer</li> <li>Insufficient refrigerant</li> <li>Outdoor PCB</li> <li>Compressor</li> </ul>
F22	IPM (power transistor) overheating protection	3 times occurrence within 30 minutes	<ul style="list-style-type: none"> <li>Improper heat exchange</li> <li>IPM (Power transistor)</li> </ul>
F23	Outdoor Direct Current (DC) peak detection	7 times occurrence continuously	<ul style="list-style-type: none"> <li>Outdoor PCB</li> <li>Compressor</li> </ul>
F24	Refrigeration cycle abnormality	2 times occurrence within 20 minutes	<ul style="list-style-type: none"> <li>Insufficient refrigerant</li> <li>Outdoor PCB</li> <li>Compressor low compression</li> </ul>
F25	Cooling/Heating cycle changeover abnormality	4 times occurrence within 30 minutes	<ul style="list-style-type: none"> <li>4-way valve</li> <li>V-coil</li> </ul>
F27	Pressure switch abnormality	Continue for 1 min.	<ul style="list-style-type: none"> <li>Pressure switch</li> </ul>
F29	Low Discharge Superheat	1 times occurrence within 2550 minutes	<ul style="list-style-type: none"> <li>Discharge Temperature sensor</li> <li>Discharge Pressure Sensor</li> <li>Pressure Switch</li> <li>Outdoor PCB</li> </ul>
F30	Water outlet sensor 2 abnormality	Continue for 5 sec.	<ul style="list-style-type: none"> <li>Water outlet sensor 2 (defective or disconnected)</li> </ul>
F32	Abnormal Internal Thermostat	Continue for 5 sec.	<ul style="list-style-type: none"> <li>Control panel PCB thermostat</li> </ul>
F36	Outdoor air temperature sensor abnormality	Continue for 5 sec.	<ul style="list-style-type: none"> <li>Outdoor air temperature sensor (defective or disconnected)</li> </ul>
F37	Indoor water inlet temperature sensor abnormality	Continue for 5 sec.	<ul style="list-style-type: none"> <li>Water inlet temperature sensor (defective or disconnected)</li> </ul>
F40	Outdoor discharge pipe temperature sensor abnormality	Continue for 5 sec.	<ul style="list-style-type: none"> <li>Outdoor discharge pipe temperature sensor (defective or disconnected)</li> </ul>
F41	PFC control	4 times occurrence within 10 minutes	<ul style="list-style-type: none"> <li>Voltage at PFC</li> </ul>
F42	Outdoor heat exchanger temperature sensor abnormality	Continue for 5 sec.	<ul style="list-style-type: none"> <li>Outdoor heat exchanger temperature sensor (defective or disconnected)</li> </ul>
F43	Outdoor defrost sensor abnormality	Continue for 5 sec.	<ul style="list-style-type: none"> <li>Outdoor defrost sensor (defective or disconnected)</li> </ul>
F45	Indoor water outlet temperature sensor abnormality	Continue for 5 sec.	<ul style="list-style-type: none"> <li>Water outlet temperature sensor (defective or disconnected)</li> </ul>
F46	Outdoor Current Transformer open circuit	—	<ul style="list-style-type: none"> <li>Insufficient refrigerant</li> <li>Outdoor PCB</li> <li>Compressor low</li> </ul>
F48	Outdoor EVA outlet temperature sensor abnormality	Continue for 5 sec.	<ul style="list-style-type: none"> <li>Outdoor EVA outlet temperature sensor (defective or disconnected)</li> </ul>
F49	Outdoor bypass outlet temperature sensor abnormality	Continue for 5 sec.	<ul style="list-style-type: none"> <li>Outdoor bypass outlet temperature sensor (defective or disconnected)</li> </ul>
F95	Cooling high pressure overload protection	—	<ul style="list-style-type: none"> <li>Outdoor high pressure sensor</li> <li>Water pump or water leakage</li> <li>Clogged expansion valve or strainer</li> <li>Excess refrigerant</li> <li>Outdoor PCB</li> </ul>

## 19.5 Self-diagnosis Method

### 19.5.1 Connection Capability Rank Abnormality (H12)

#### Malfunction Decision Conditions:

During startup operation of cooling and heating, the capability rank of indoor checked by the outdoor is used to determine connection capability rank abnormality.

#### Malfunction Caused:

- 1 Wrong model interconnected.
- 2 Wrong indoor unit or outdoor unit PCB (main) used.
- 3 Faulty indoor unit or outdoor unit PCB (main).

#### Abnormality Judgment:

Continue for 90 seconds.

### Troubleshooting:

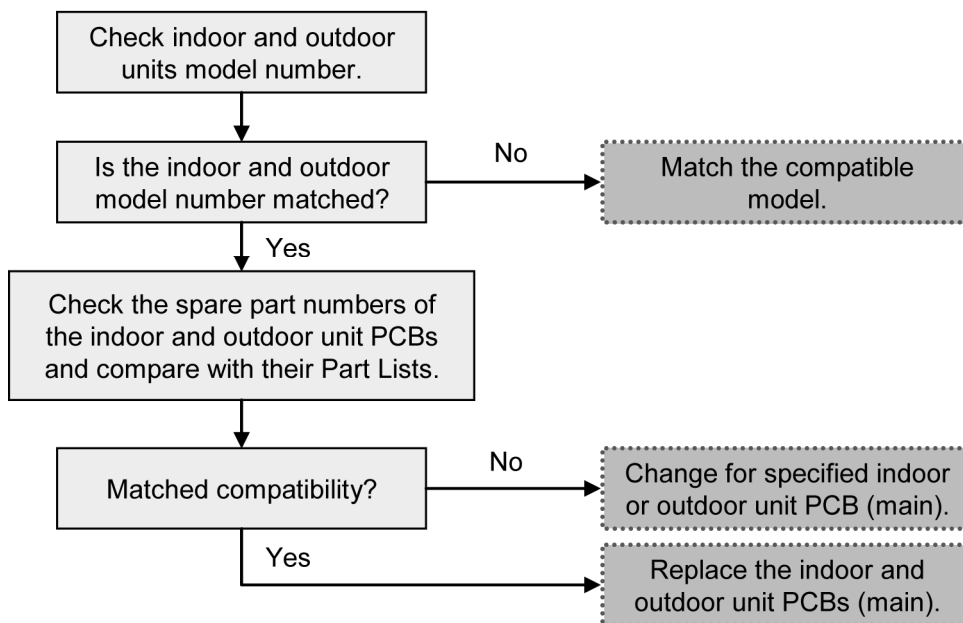

## 19.5.2 Compressor Tank Temperature Sensor Abnormality (H15)

### Malfunction Decision Conditions:

During startup and operation of cooling and heating, the temperatures detected by the compressor tank temperature sensor are used to determine sensor error.

### Malfunction Caused:

- 1 Faulty connector connection.
- 2 Faulty sensor.
- 3 Faulty outdoor unit PCB (main).

### Abnormality Judgment:

Continue for 5 seconds.

### Troubleshooting:

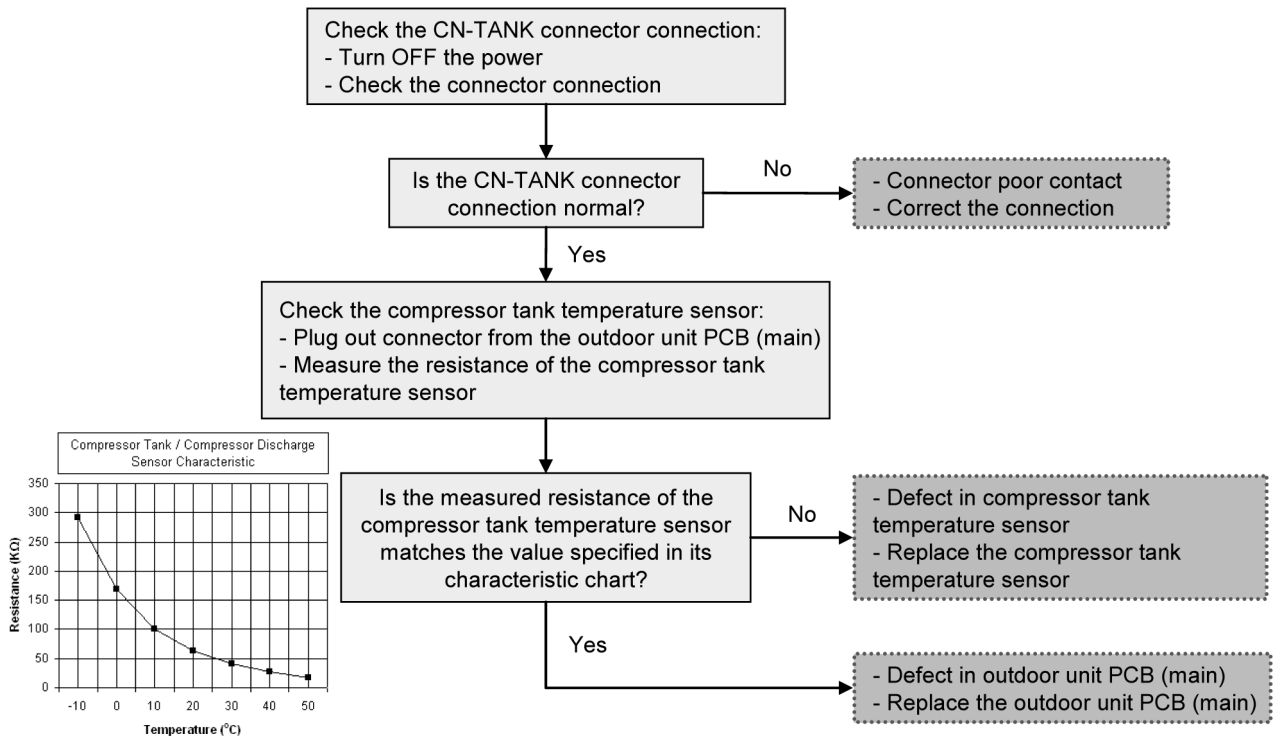

### 19.5.3 Water Pump Abnormality (H20)

#### Malfunction Decision Conditions:

During startup and operation of cooling and heating, the rotation speed detected by the IPM of water pump motor during water pump operation is used to determine abnormal water pump (feedback of rotation > 6,000rpm or < 1,000rpm).

#### Malfunction Caused:

- 1 Operation stop due to short circuit inside the water pump motor winding.
- 2 Operation stop due to breaking of wire inside the water pump motor.
- 3 Operation stop due to breaking of water pump lead wires.
- 4 Operation stop due to water pump motor IPM malfunction.
- 5 Operation error due to faulty indoor unit PCB.

#### Abnormality Judgment:

Continue for 5 seconds.

#### Troubleshooting:



**Caution**

For safety reason and to prevent component breakdown, always switch off the power before remove and connect the component.

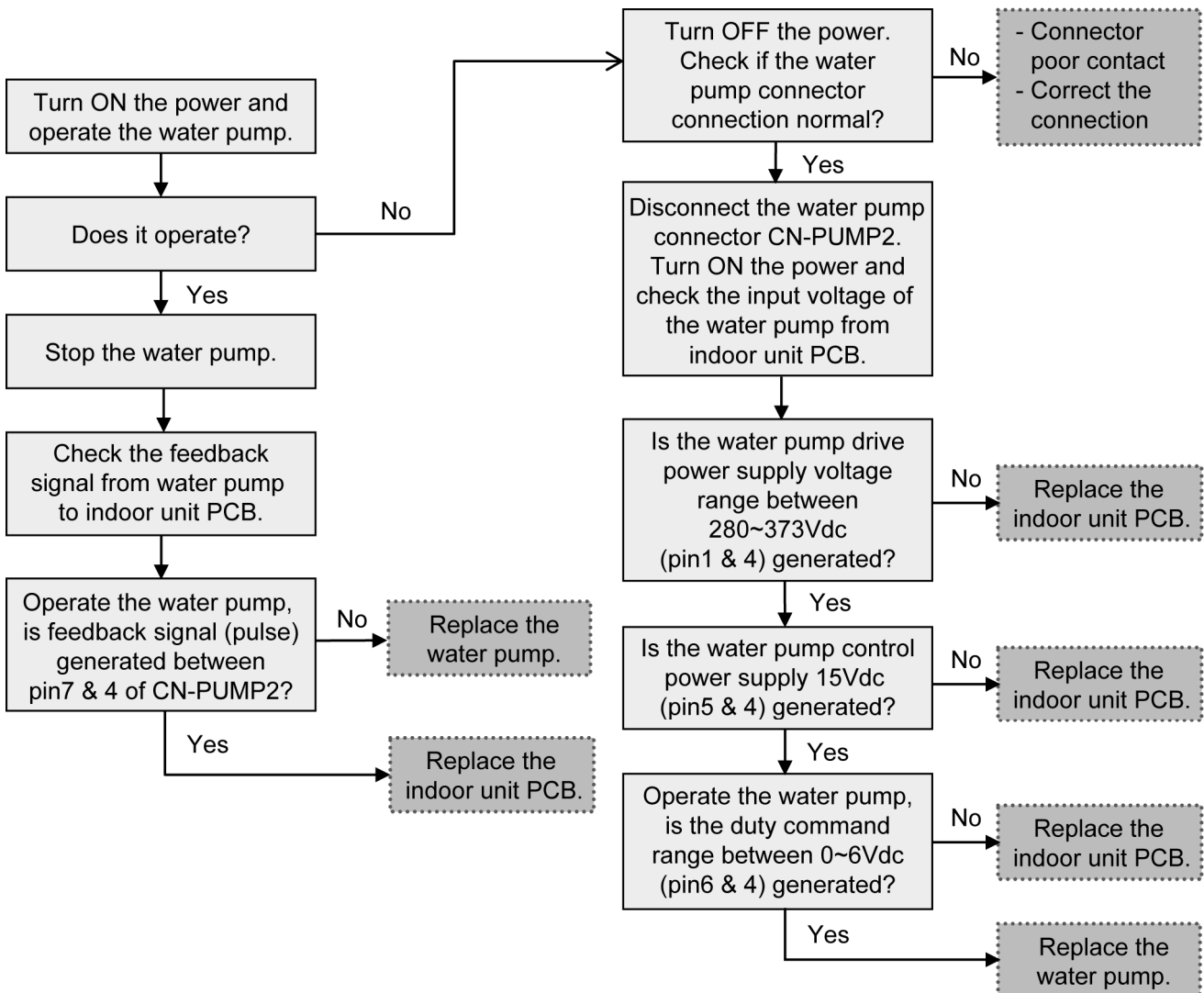



## 19.5.4 Indoor Refrigerant Liquid Temperature Sensor Abnormality (H23)

### Malfunction Decision Conditions:

During startup and operation of cooling and heating, the temperatures detected by the indoor refrigerant liquid temperature sensor are used to determine sensor error.

### Malfunction Caused:

- 1 Faulty connector connection.
- 2 Faulty sensor.
- 3 Faulty indoor unit PCB (main).

### Abnormality Judgment:

Continue for 5 seconds.

### Troubleshooting:



**Caution**

For safety reason and to prevent component breakdown, always switch off the power before remove and connect the component.

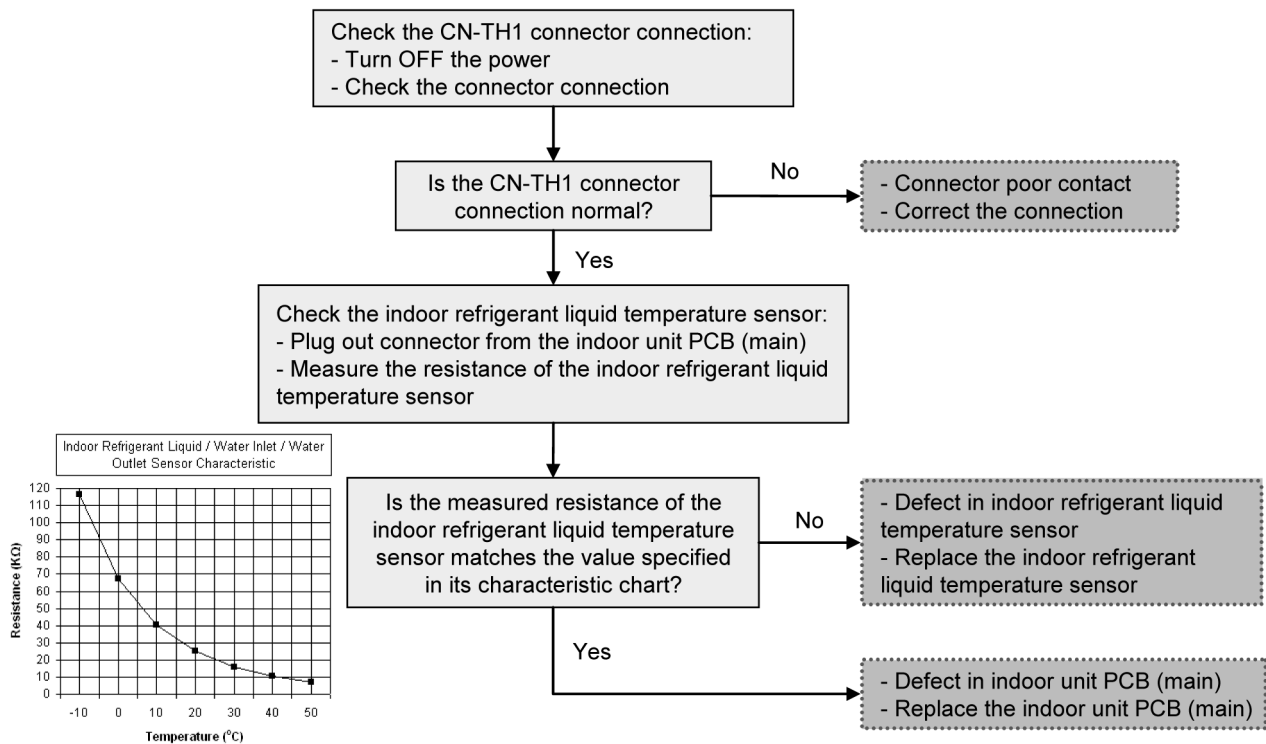

## 19.5.5 Service Valve Error (H27)

### Malfunction Decision Conditions:

During cooling operation, when:-

[a] Indoor refrigerant pipe temperature at compressor startup - present indoor refrigerant pipe temperature  $< 2^{\circ}\text{C}$

[b] Present high pressure - high pressure at compressor startup  $< 5\text{kg}/\text{cm}^2$

\*\*Judgment only for first time cooling operation and not during pump down operation.

### Malfunction Caused:

- 1 3 way valves closed.
- 2 Faulty high pressure sensor.
- 3 Faulty indoor refrigerant pipe temperature sensor
- 4 Faulty outdoor unit PCB (main).

### Abnormality Judgment:

Continue for 5 minutes.

### Troubleshooting:



**Caution**

For safety reason and to prevent component breakdown, always switch off the power before remove and connect the component.

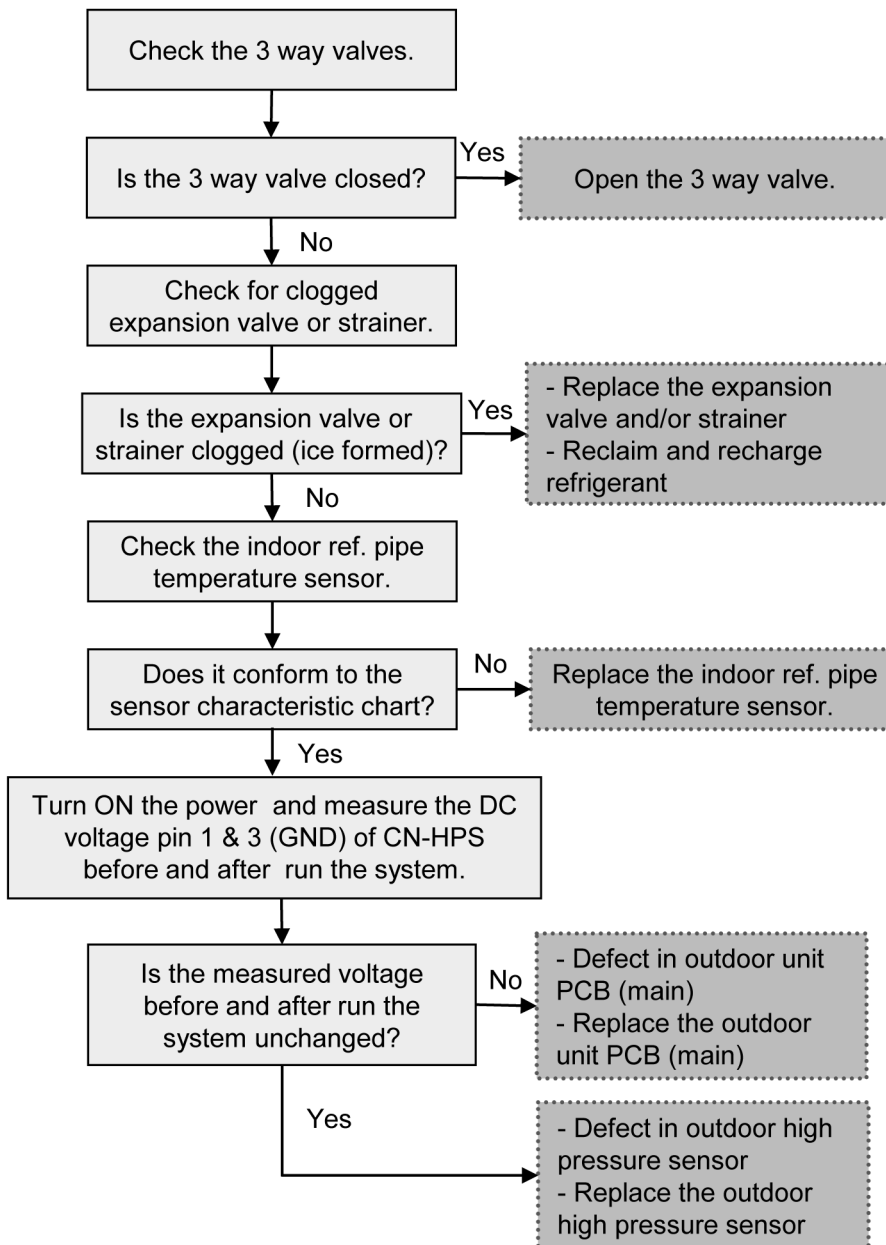

## 19.5.6 Abnormal Solar Sensor (H28)

### Malfunction Caused:

- 1 Faulty connector connection.
- 2 Faulty solar sensor.
- 3 Faulty indoor sub PCB.

### Abnormality Judgment:

Continue for 5 seconds.

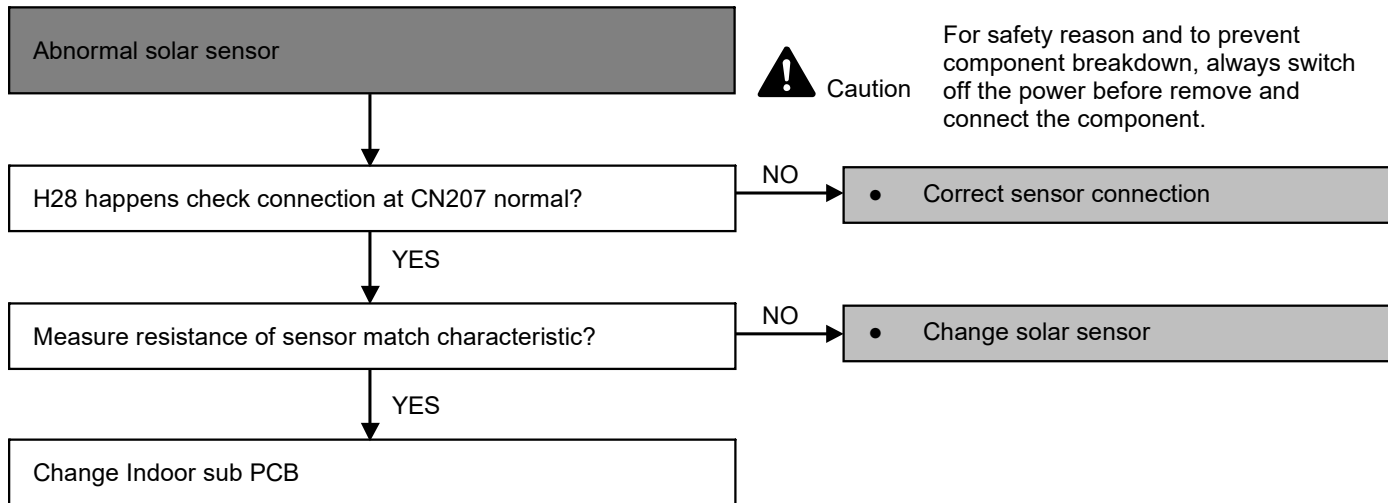

## 19.5.7 Abnormal Swimming Pool Sensor (H31)

### Malfunction Caused:

- 1 Faulty connector connection.
- 2 Faulty swimming pool sensor.
- 3 Faulty indoor sub PCB.

### Abnormality Judgment:

Continue for 5 seconds.

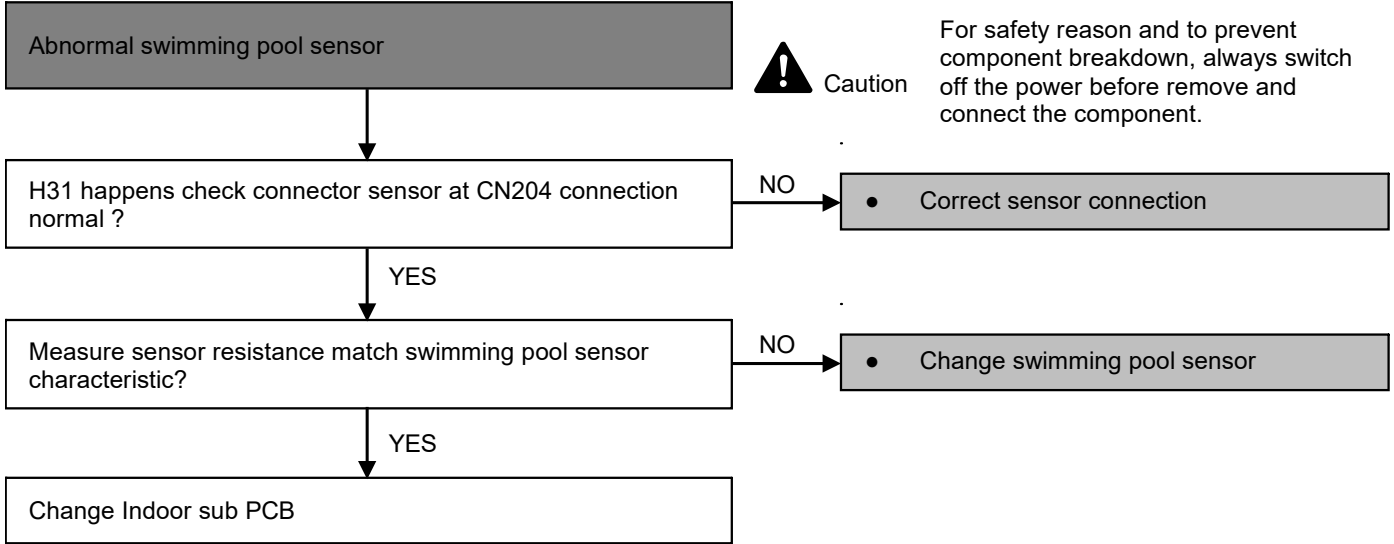

### 19.5.8 Abnormal Buffer Tank Sensor (H36)

**Malfunction Caused:**

- 1 Faulty connector connection.
- 2 Faulty buffer tank sensor.
- 3 Faulty indoor sub PCB.

**Abnormality Judgment:**

Continue for 5 seconds.

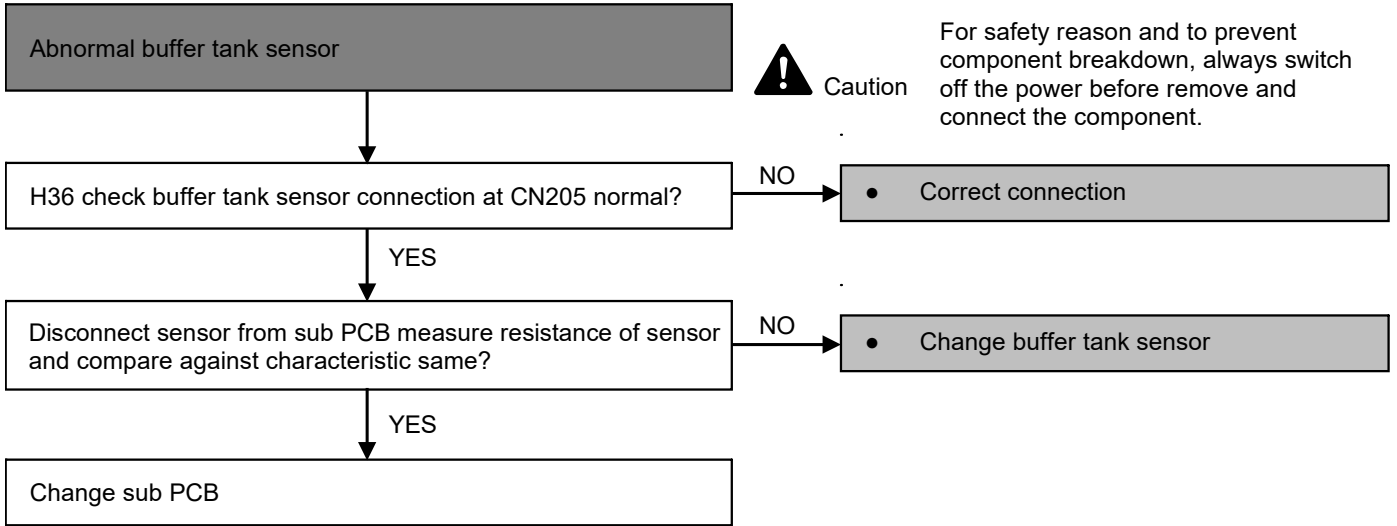

## 19.5.9 Brand Code Not Matching (H38)

### Malfunction Caused:

- 1 Indoor and outdoor brand code not match.

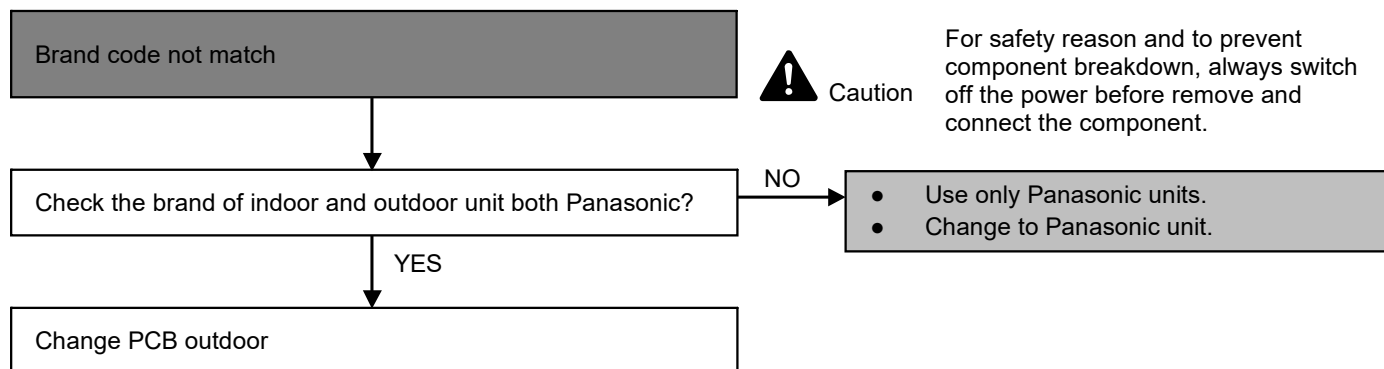

### 19.5.10 Compressor Low Pressure Protection (H42)

**Malfunction Decision Conditions:**

During operation of heating and after 5 minutes compressor ON, when outdoor pipe temperature below -29°C or above 26°C is detected by the outdoor pipe temperature sensor.

**Malfunction Caused:**

- 1 Dust accumulation on the outdoor unit heat exchanger.
- 2 Air short circuit at outdoor unit.
- 3 2 way valve partially closed.
- 4 Faulty outdoor unit fan motor.
- 5 Refrigerant shortage (refrigerant leakage).
- 6 Clogged expansion valve or strainer.
- 7 Faulty outdoor pipe temperature sensor.
- 8 Faulty outdoor unit main PCB (main).

**Troubleshooting:**



For safety reason and to prevent component breakdown, always switch off the power before remove and connect the component.

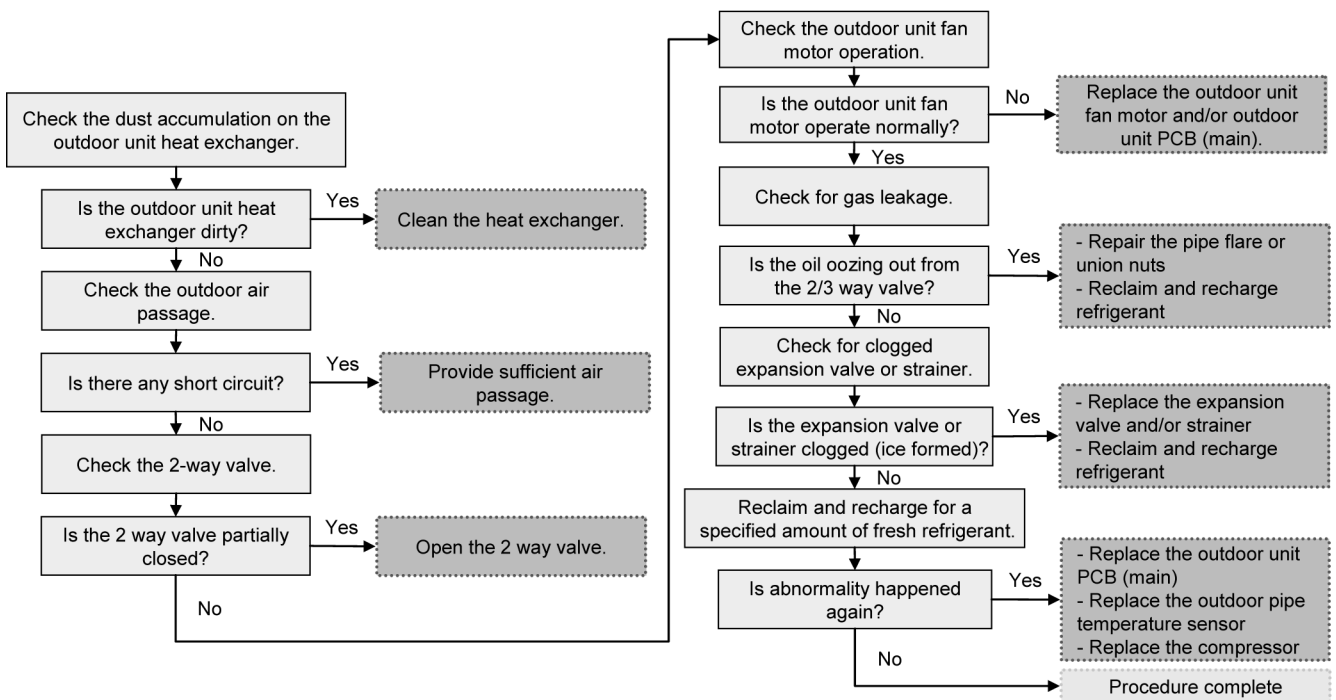

### 19.5.11 Abnormal Zone 1 Sensor (H43)

**Malfunction Caused:**

- 1 Faulty connector connection.
- 2 Faulty buffer tank sensor.
- 3 Faulty indoor sub PCB.

**Abnormality Judgment:**

Continue for 5 seconds.

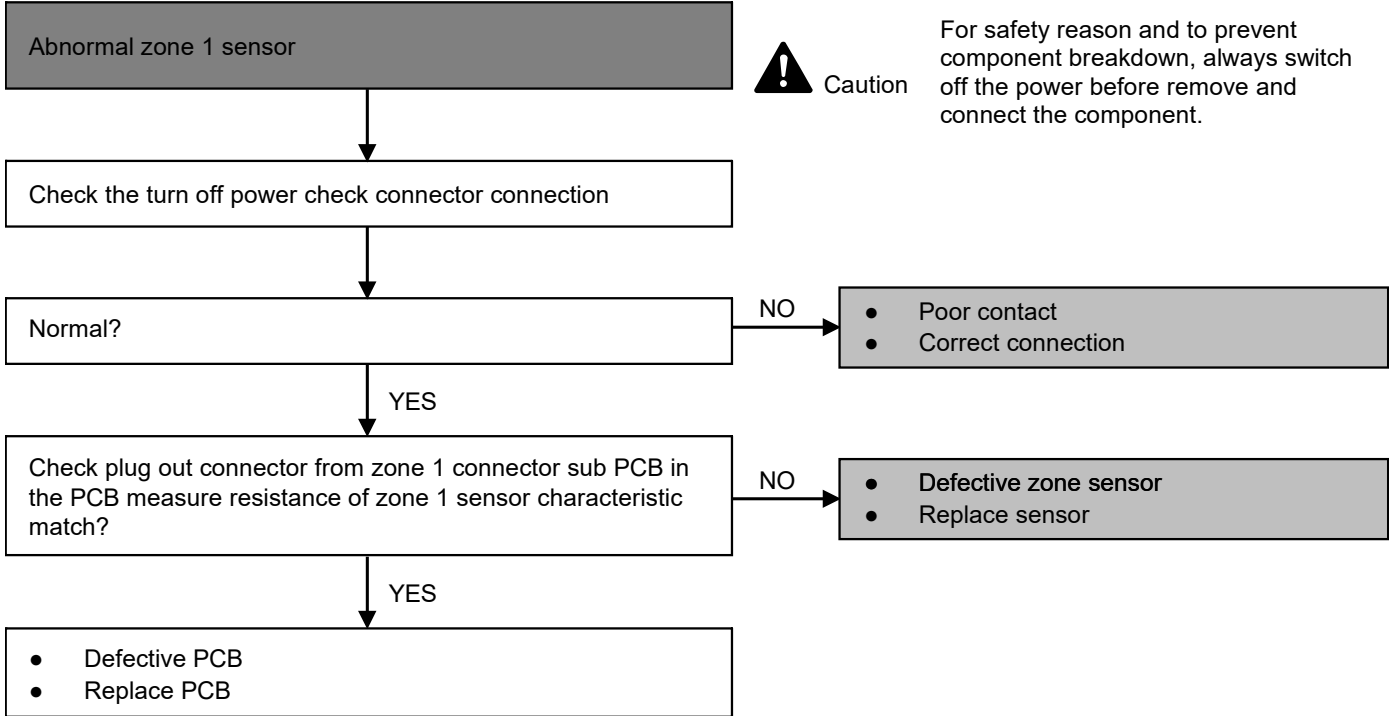



### 19.5.12 Abnormal Zone 2 Sensor (H44)

**Malfunction Caused:**

- 1 Faulty connector connection.
- 2 Faulty buffer tank sensor.
- 3 Faulty indoor sub PCB.

**Abnormality Judgment:**

Continue for 5 seconds.

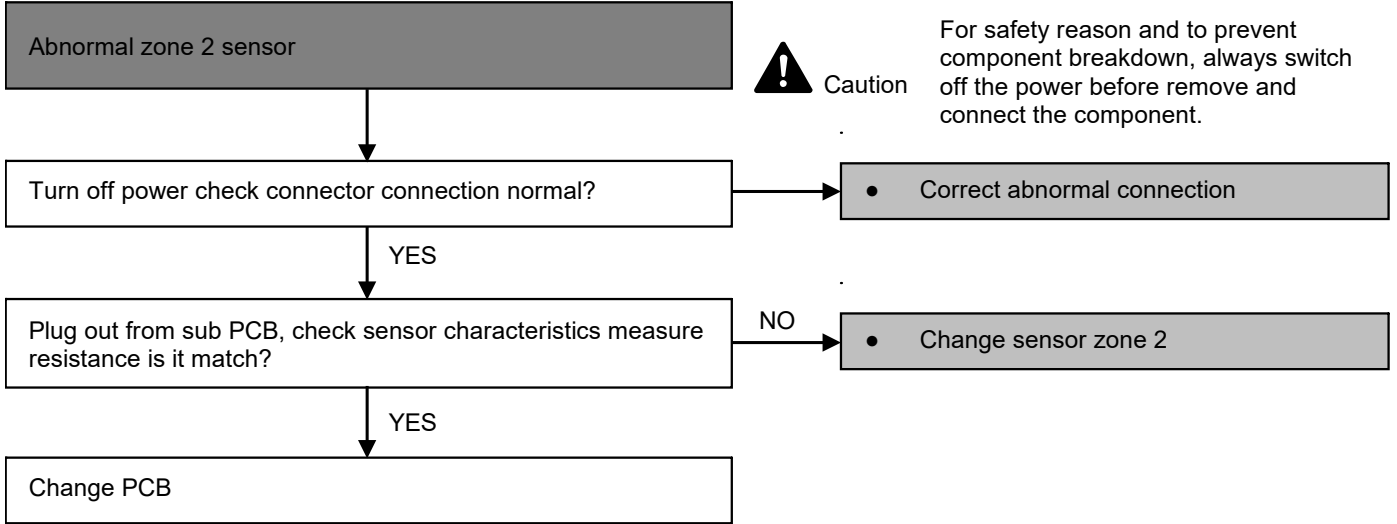

## 19.5.13 Water Flow Switch Abnormality (H62)

### Malfunction Decision Conditions:

During operation of cooling and heating, the water flow detected by the indoor water flow switch is used to determine water flow error.

### Malfunction Caused:

- 1 Faulty water pump.
- 2 Water leak in system.
- 3 Faulty connector connection.
- 4 Faulty water flow switch.
- 5 Faulty indoor unit PCB (main).

### Abnormality Judgment:

Continue for 10 seconds (but no judgment for 9 minutes after compressor startup/restart).

### Troubleshooting:



**Caution**

For safety reason and to prevent component breakdown, always switch off the power before remove and connect the component.

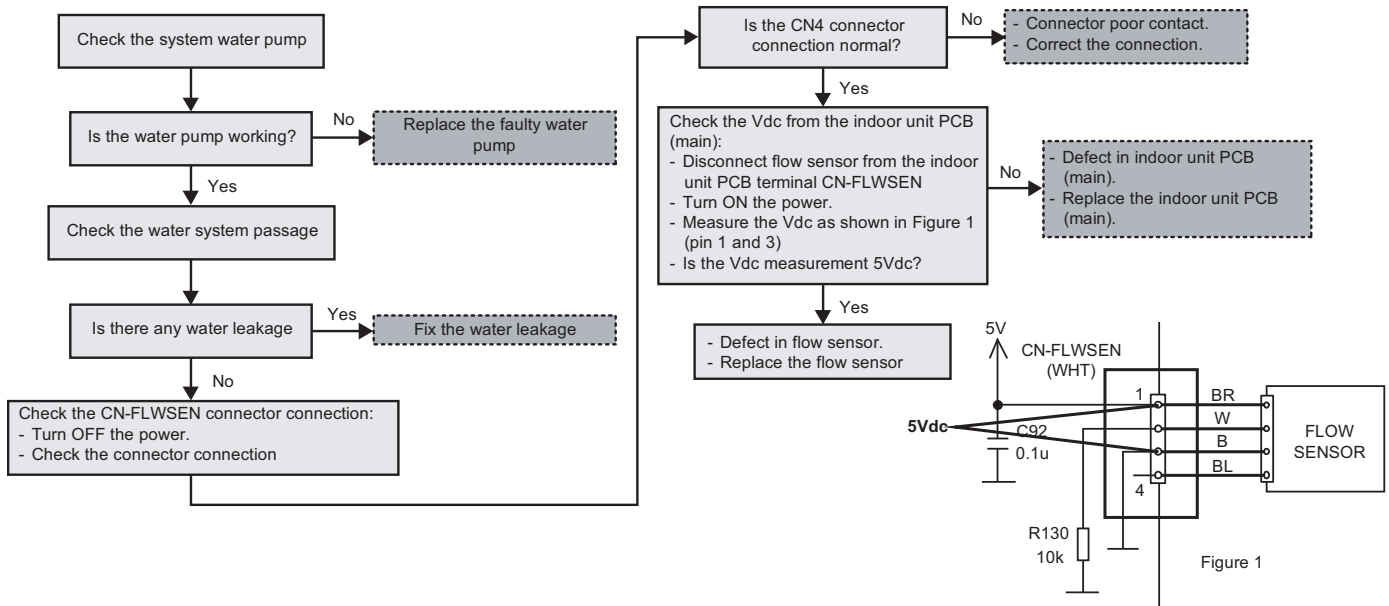

### 19.5.14 Outdoor High Pressure Abnormality (H64)

**Malfunction Decision Conditions:**

During operation of cooling and heating, when the outdoor high pressure sensor output signal is 0 Vdc or 5 Vdc.

**Malfunction Caused:**

- 1 Faulty connector connection.
- 2 Faulty sensor.
- 3 Faulty outdoor unit PCB (main).

**Abnormality Judgment:**

Continue 4 times in 20 minutes.

**Troubleshooting:**



**Caution**

For safety reason and to prevent component breakdown, always switch off the power before remove and connect the component.

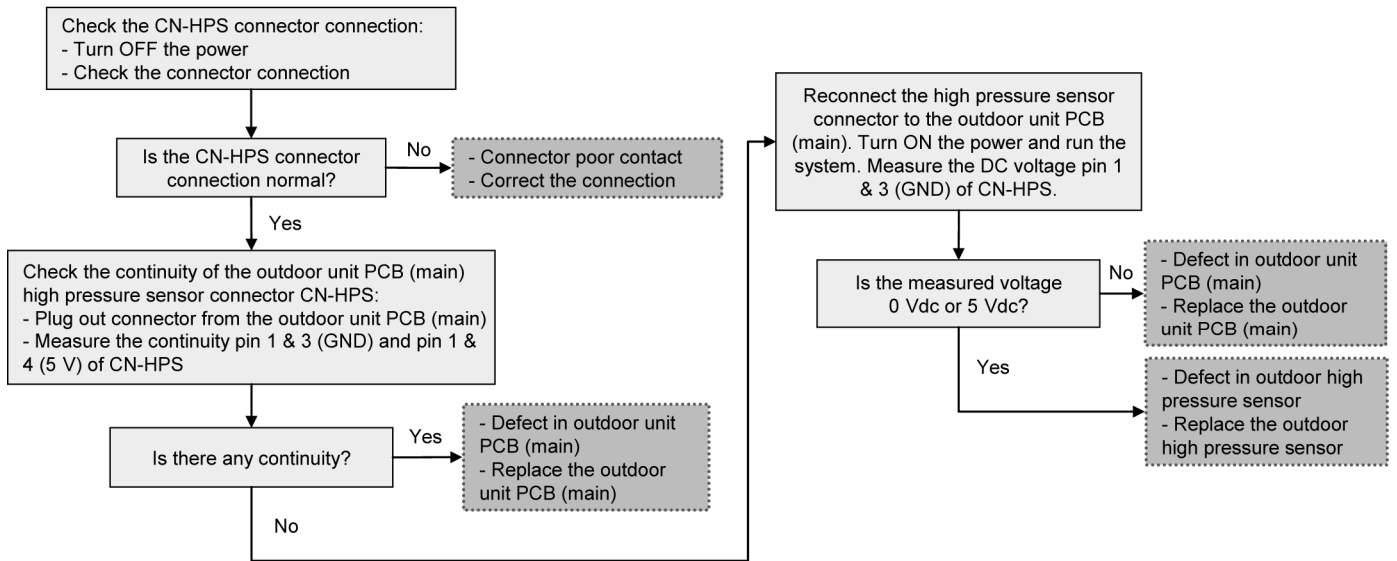

## 19.5.15 Deice Circulation Error (H65)

### Malfunction Decision Conditions:

During startup and operation of deice (mode 2), the water flow (> 10l/min) detected by the water flow switch is used to determine deice circulation error.

### Malfunction Caused:

- 1 Water flow in air-to-water heatpump indoor unit circuitry.
- 2 Faulty indoor unit water flow switch.
- 3 Faulty indoor unit water pump.
- 4 Faulty indoor unit PCB.

### Abnormality Judgment:

Continue for 10 seconds.

## Troubleshooting:



For safety reason and to prevent component breakdown, always switch off the power before remove and connect the component.

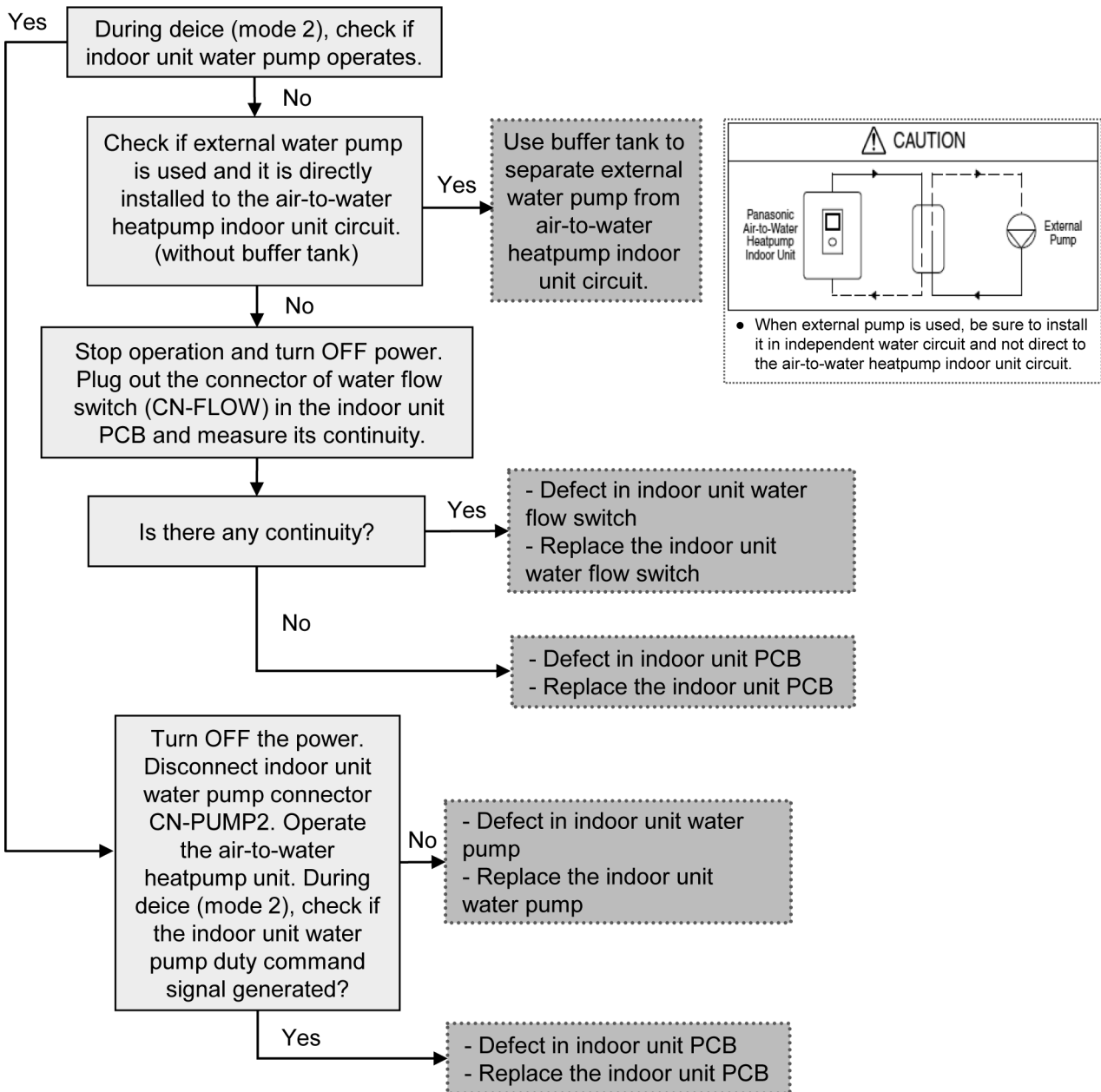

### 19.5.16 Abnormal External Thermistor 1 (H67)

**Malfunction Caused:**

- 1 Faulty connector connection.
- 2 Faulty room temperature zone 1 sensor.
- 3 Faulty indoor sub PCB.

**Abnormality Judgment:**

Continue for 5 seconds.

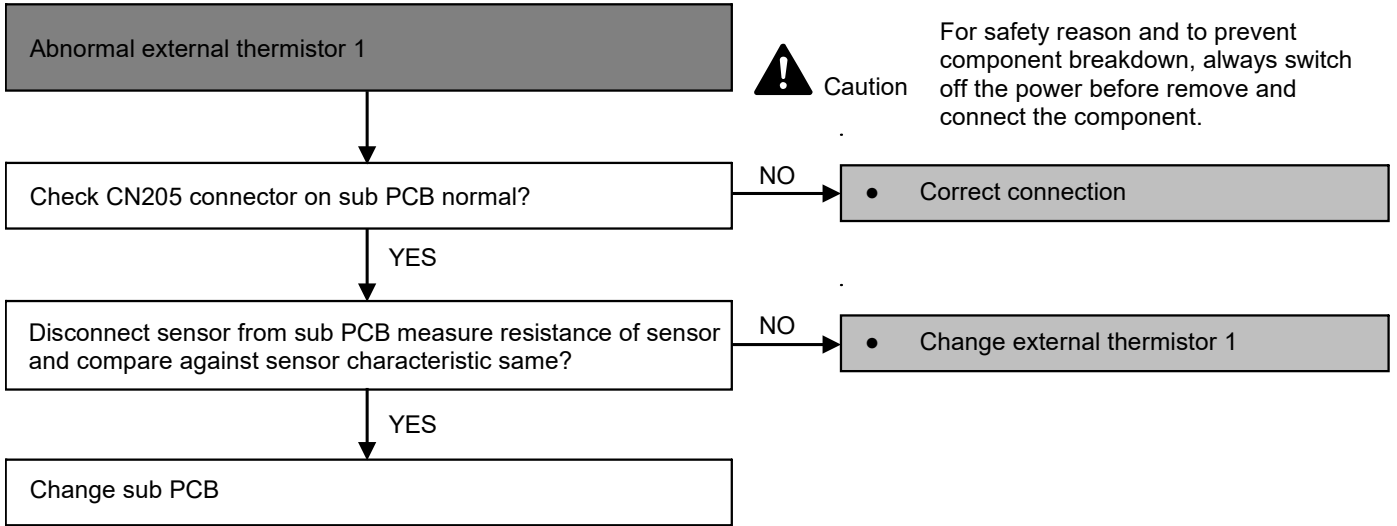

### 19.5.17 Abnormal External Thermistor 2 (H68)

**Malfunction Caused:**

- 1 Faulty connector connection.
- 2 Faulty room temperature zone 2 sensor.
- 3 Faulty indoor sub PCB.

**Abnormality Judgment:**

Continue for 5 seconds.

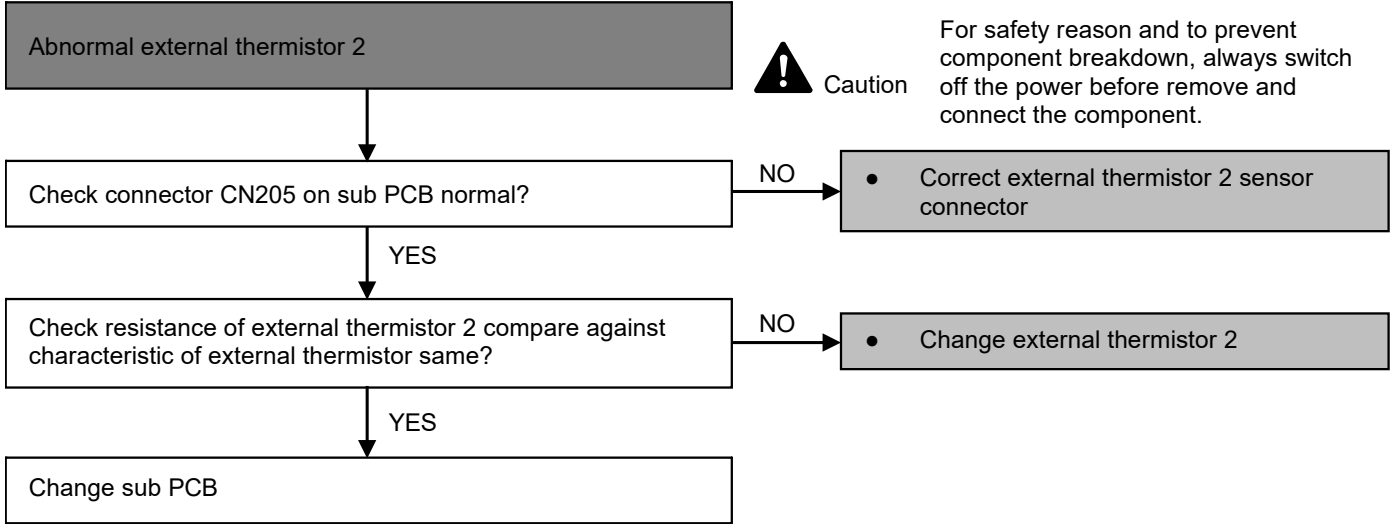

### 19.5.18 Indoor Backup Heater OLP Abnormality (H70)

**Malfunction Decision Conditions:**

During operation of indoor backup heater, when no power supplies to indoor backup heater or OLP open circuit.

**Malfunction Caused:**

- 1 Faulty power supply connector connection.
- 2 Faulty connector connection.
- 3 Faulty indoor backup heater overload protector (OLP).
- 4 Faulty indoor unit PCB (main).

**Abnormality Judgment:**

Continue for 60 seconds.

**Troubleshooting:**



**Caution**

For safety reason and to prevent component breakdown, always switch off the power before remove and connect the component.

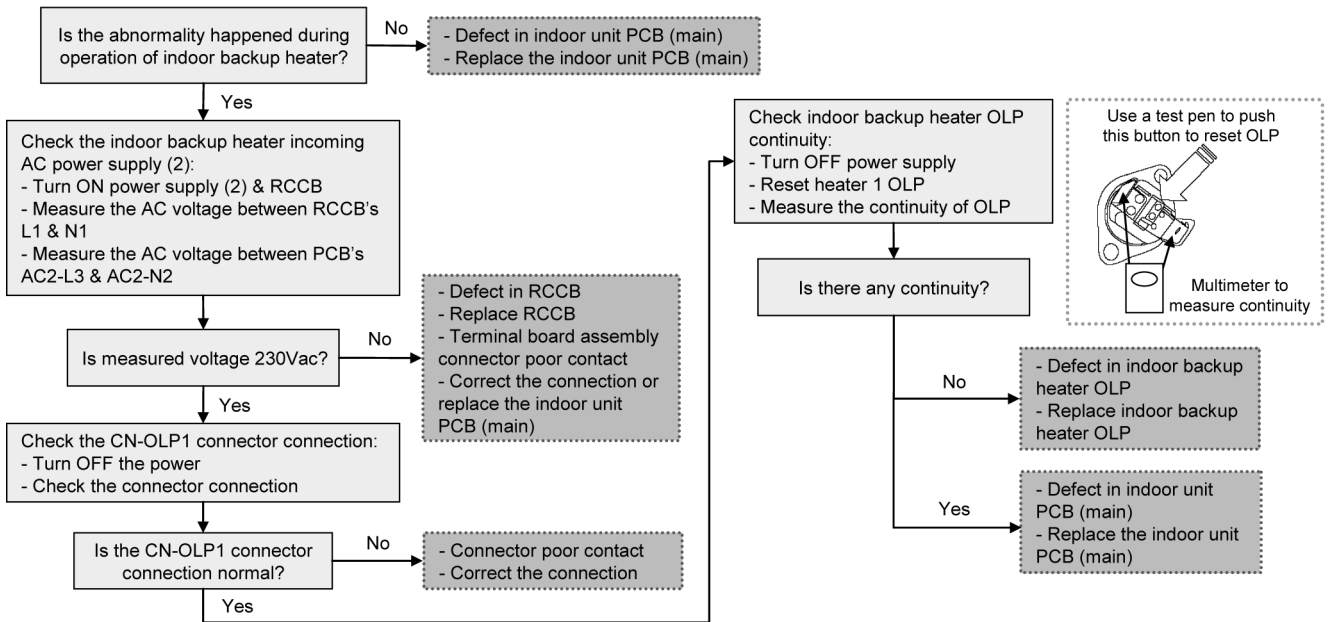

## 19.5.19 Tank Temperature Sensor Abnormality (H72)

### Malfunction Decision Conditions:

When tank connection is set to ON, the temperatures detected by the tank temperature sensor are used to determine sensor error.

### Malfunction Caused:

- 1 Faulty connector connection.
- 2 Faulty sensor.
- 3 Faulty indoor unit PCB (main).

### Abnormality Judgment:

Continue for 5 seconds.

### Troubleshooting:



**Caution**

For safety reason and to prevent component breakdown, always switch off the power before remove and connect the component.

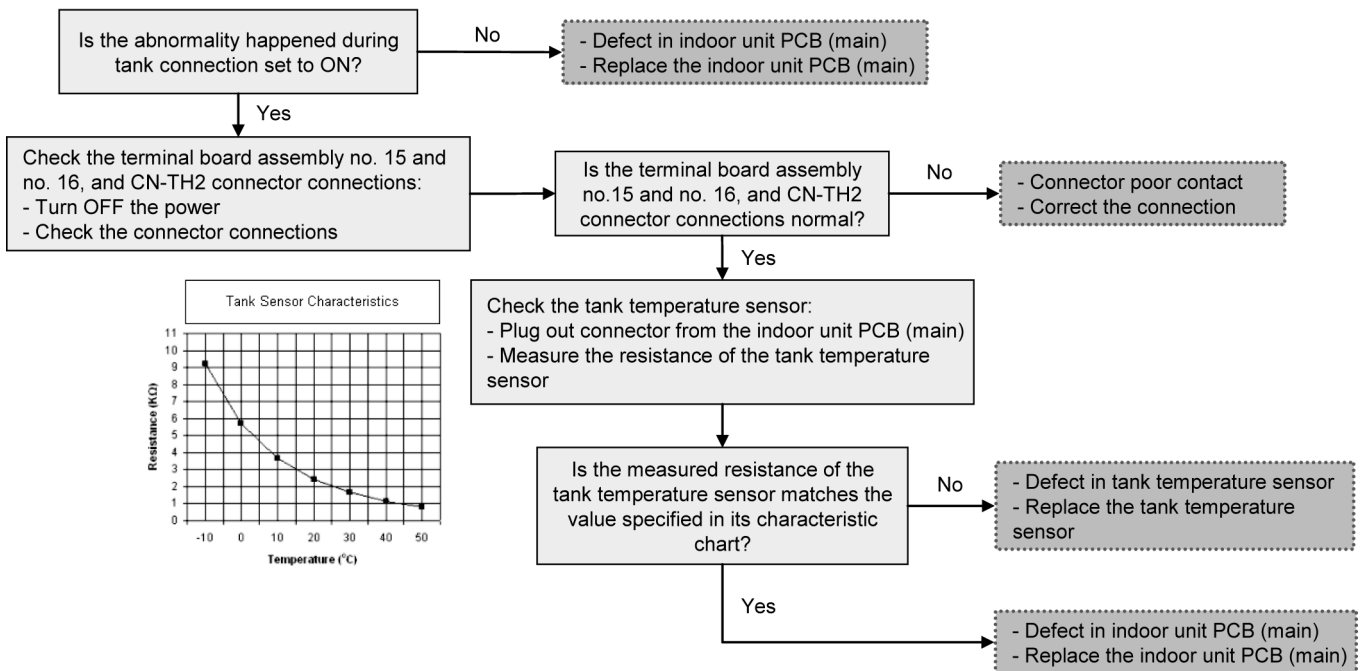



### 19.5.20 PCB Communication Error (H74)

#### Malfunction Decision Conditions:

When External PCB connection is select "YES" and no communication with External PCB micon for 10 seconds and above.

#### Malfunction Caused:

- 1 Faulty connector connection.
- 2 Faulty indoor PCB.
- 3 Faulty indoor sub PCB.

#### Abnormality Judgment:

After 1 minute operation started.

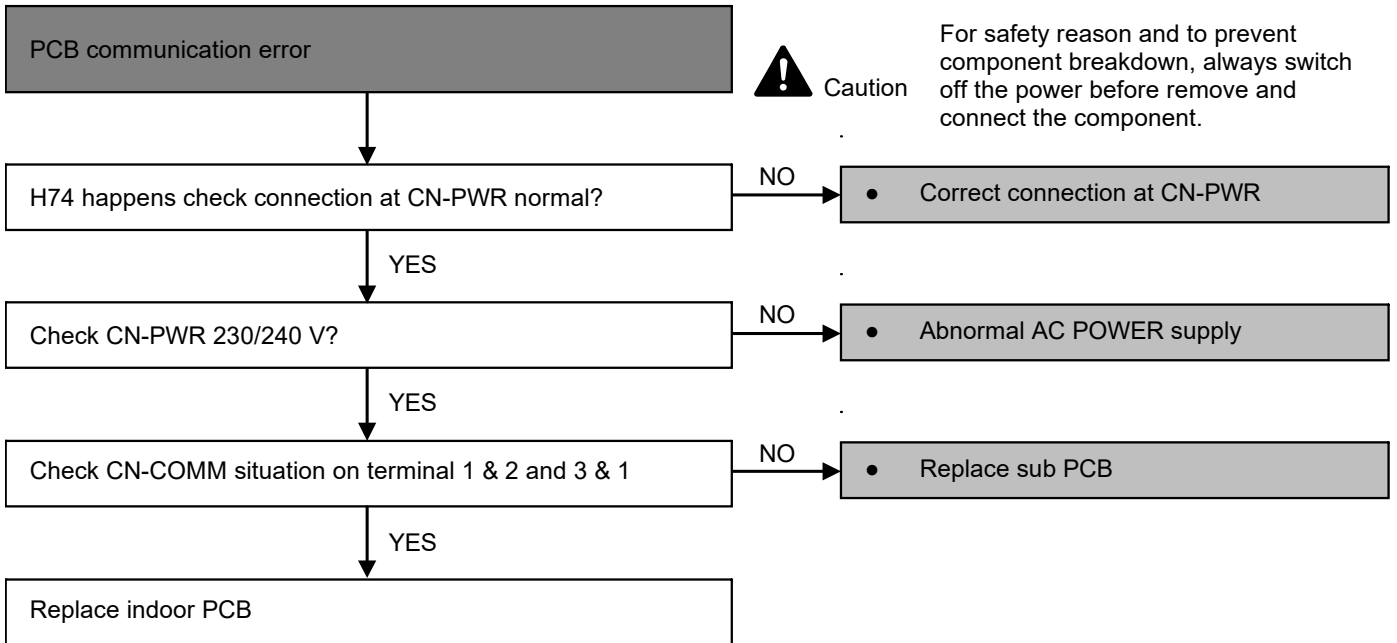

## 19.5.21 Indoor-Control Panel Communication Abnormality (H76)

### Malfunction Decision Conditions:

During standby and operation of cooling and heating, indoor-control panel error occur.

### Malfunction Caused:

- 1 Faulty connector connection.
- 2 Faulty control panel.
- 3 Faulty indoor unit PCB (main).

### Troubleshooting: **Caution**

For safety reason and to prevent component breakdown, always switch off the power before remove and connect the component.

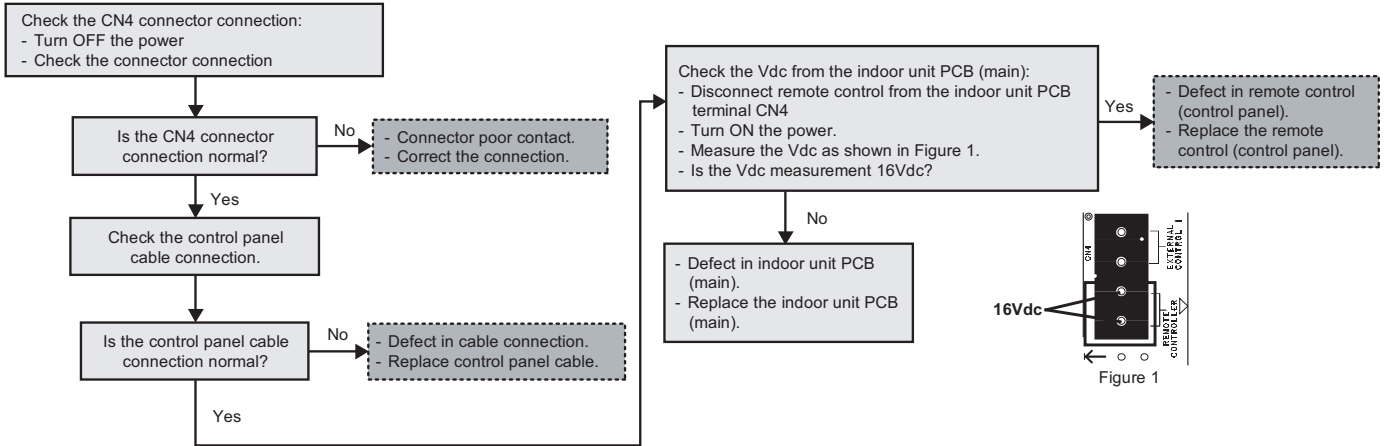

## 19.5.22 Indoor/Outdoor Abnormal Communication (H90)

### Malfunction Decision Conditions:

During operation of cooling and heating, the data received from outdoor unit in indoor unit signal transmission is checked whether it is normal.

### Malfunction Caused:

- 1 Faulty outdoor unit PCB (main).
- 2 Faulty indoor unit PCB (main).
- 3 Indoor-outdoor signal transmission error due to wrong wiring.
- 4 Indoor-outdoor signal transmission error due to breaking of wire in the connection wires between the indoor and outdoor units.
- 5 Indoor-outdoor signal transmission error due to disturbed power supply waveform.

### Abnormality Judgment:

Continue for 1 minute after operation.

### Troubleshooting:



For safety reason and to prevent component breakdown, always switch off the power before remove and connect the component.

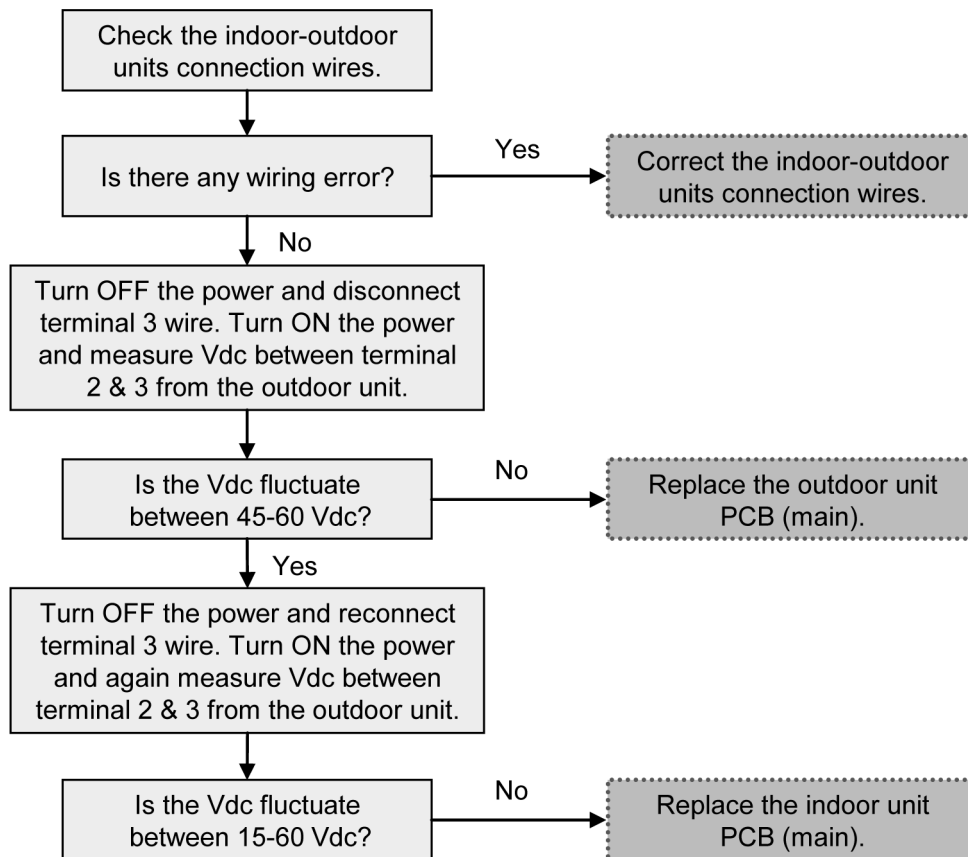

### 19.5.23 Tank Booster Heater OLP Abnormality (H91)

#### Malfunction Decision Conditions:

During operation of tank booster heater, and tank booster heater OLP open circuit.

#### Malfunction Caused:

- 1 Faulty connector connection.
- 2 Faulty tank booster heater overload protector (OLP).
- 3 Faulty indoor unit PCB (main).

#### Abnormality Judgment:

Continue for 60 seconds.

#### Troubleshooting:



For safety reason and to prevent component breakdown, always switch off the power before remove and connect the component.

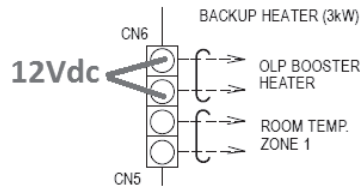
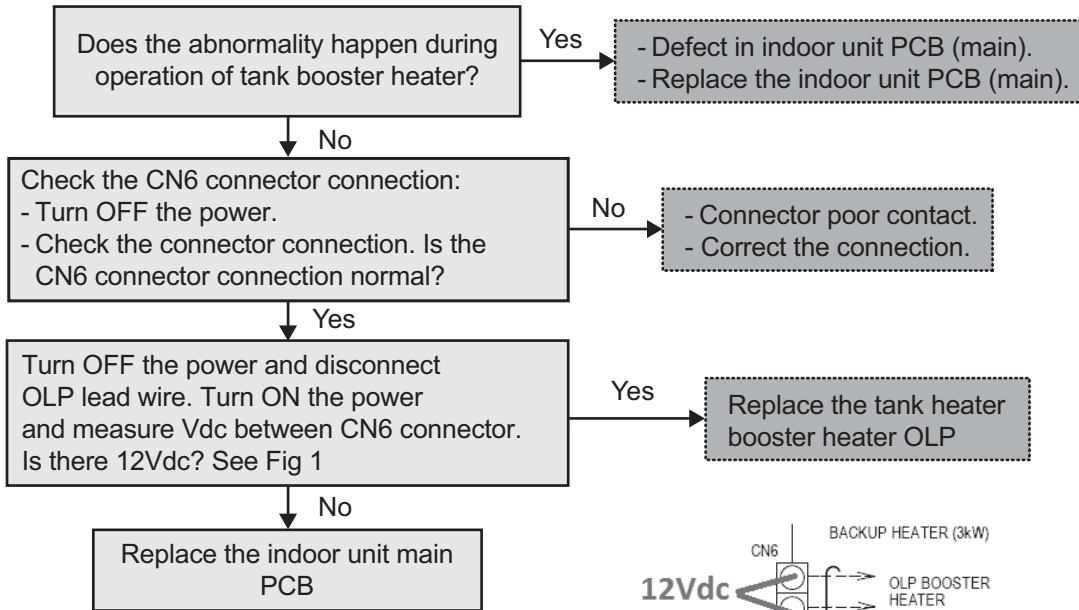

Fig 1

## 19.5.24 Unspecified Voltage between Indoor and Outdoor (H95)

### Malfunction Decision Conditions:

The supply power is detected for its requirement by the indoor/outdoor transmission.

### Malfunction Caused:

- 1 Insufficient power supply.
- 2 Faulty outdoor unit PCB (noise filter/main).

### Troubleshooting:



**Caution**

For safety reason and to prevent component breakdown, always switch off the power before remove and connect the component.

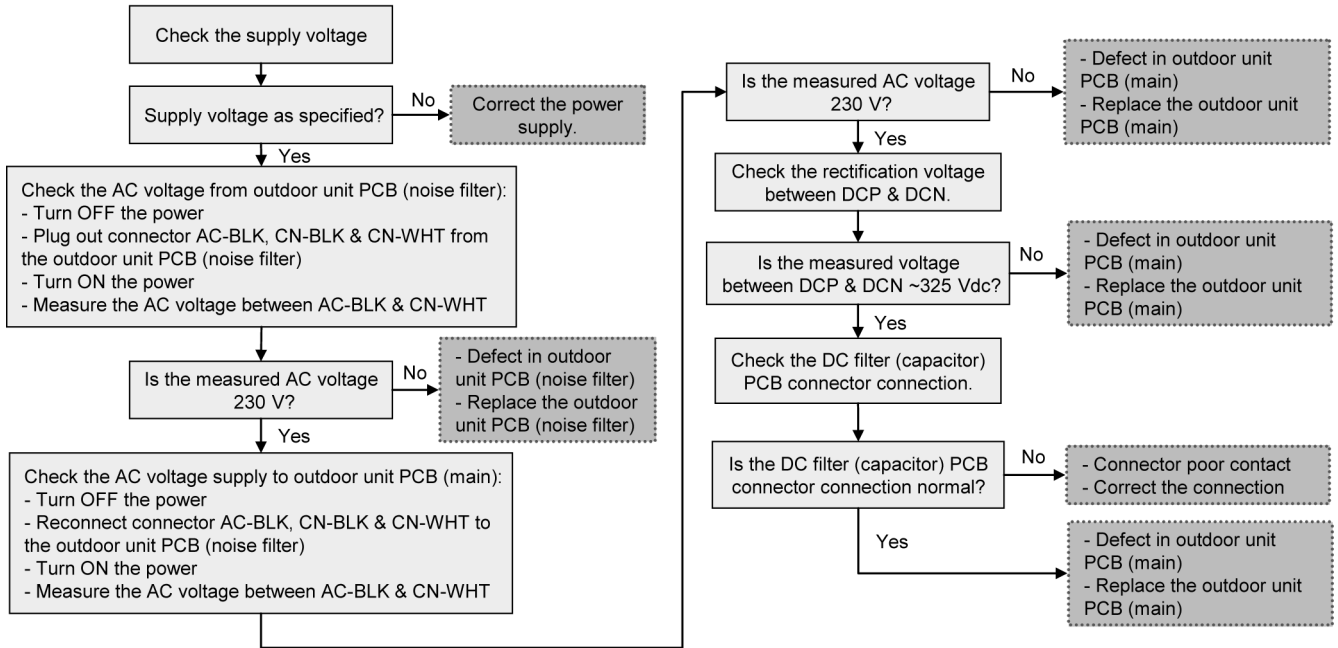

## 19.5.25 Outdoor High Pressure Protection (H98)

### Malfunction Decision Conditions:

During operation of heating, when pressure 4.0 MPa and above is detected by outdoor high pressure sensor.

### Malfunction Caused:

- 1 Faulty water pump.
- 2 Insufficient water flow rate in system.
- 3 Water leak in system.
- 4 2/3 way closed.
- 5 Clogged expansion valve or strainer.
- 6 Excessive refrigerant.
- 7 Faulty outdoor high pressure sensor.
- 8 Faulty outdoor unit PCB (main).

### Troubleshooting:



**Caution**

For safety reason and to prevent component breakdown, always switch off the power before remove and connect the component.

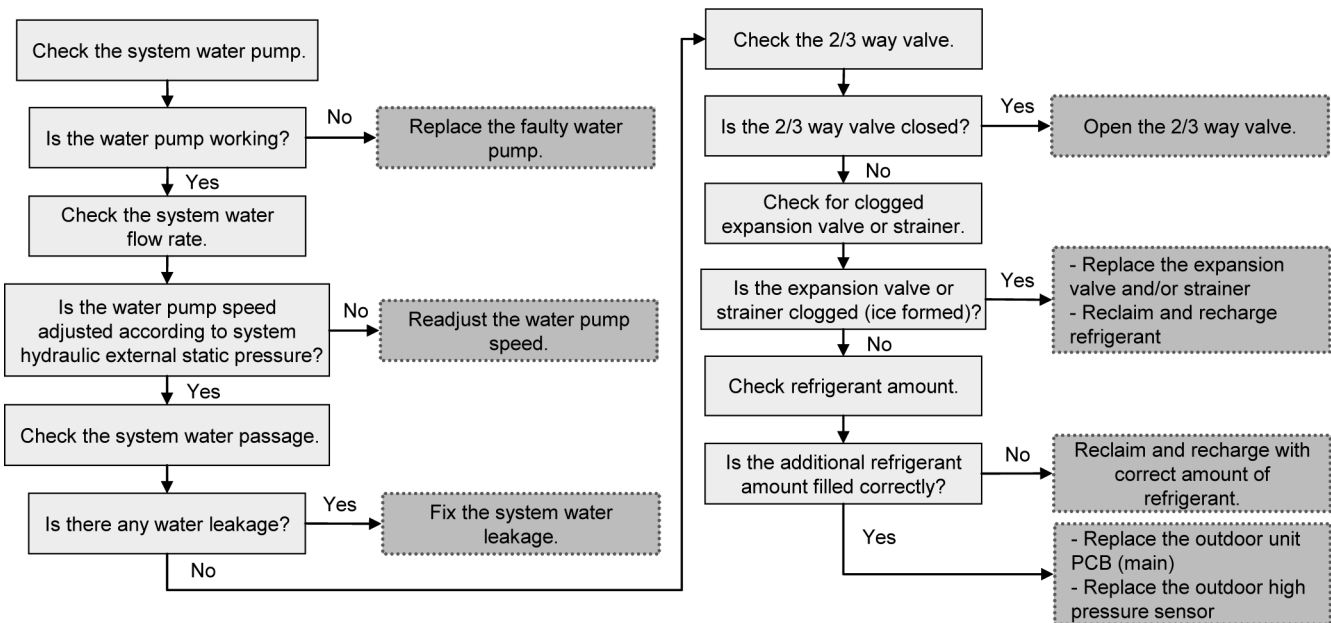

## 19.5.26 Indoor Freeze-up Protection (H99)

### Malfunction Decision Conditions:

During anti-freezing control in cooling operation, when the indoor refrigerant liquid temperature  $< 0^{\circ}\text{C}$ .

### Malfunction Caused:

- 1 Faulty water pump.
- 2 Insufficient water flow rate in system.
- 3 Water leak in system.
- 4 2 way valve partially closed.
- 5 Clogged expansion valve or strainer.
- 6 Refrigerant shortage (refrigerant leakage).
- 7 Faulty indoor refrigerant liquid temperature sensor.
- 8 Faulty indoor unit PCB (main).

### Troubleshooting:



**Caution**

For safety reason and to prevent component breakdown, always switch off the power before remove and connect the component.

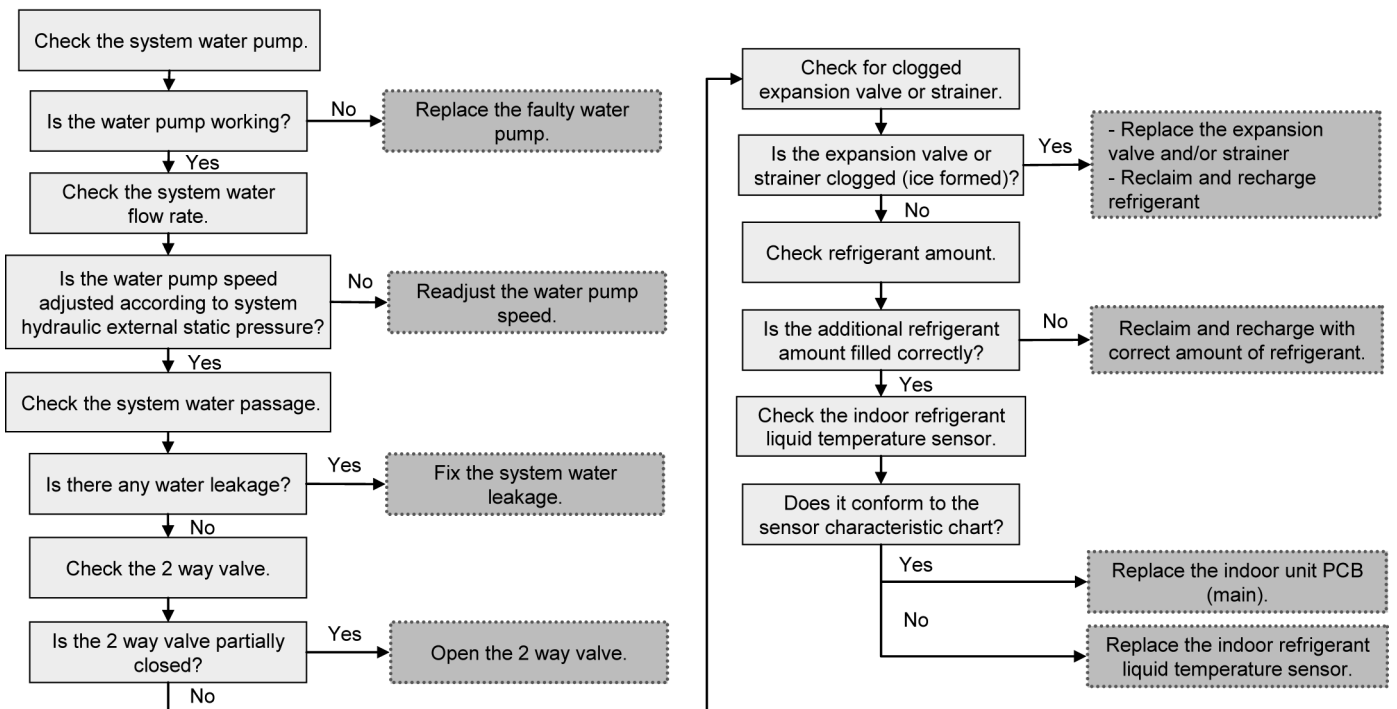

## 19.5.27 Outdoor High Pressure Switch Activate (F12)

### Malfunction Decision Conditions:

During operation of cooling and heating, when pressure 4.5 MPa and above is detected by outdoor high pressure switch.

### Malfunction Caused:

- 1 Dust accumulation on the outdoor unit heat exchanger.
- 2 Air short circuit at outdoor unit.
- 3 Faulty water pump.
- 4 Insufficient water flow rate in system.
- 5 Water leak in system.
- 6 2/3 way valve closed.
- 7 Clogged expansion valve or strainer.
- 8 Excessive refrigerant.
- 9 Faulty outdoor high pressure sensor and switch.
- 10 Faulty outdoor unit PCB.

### Abnormality Judgment:

Continue 4 times in 20 minutes.

### Troubleshooting:



For safety reason and to prevent component breakdown, always switch off the power before remove and connect the component.

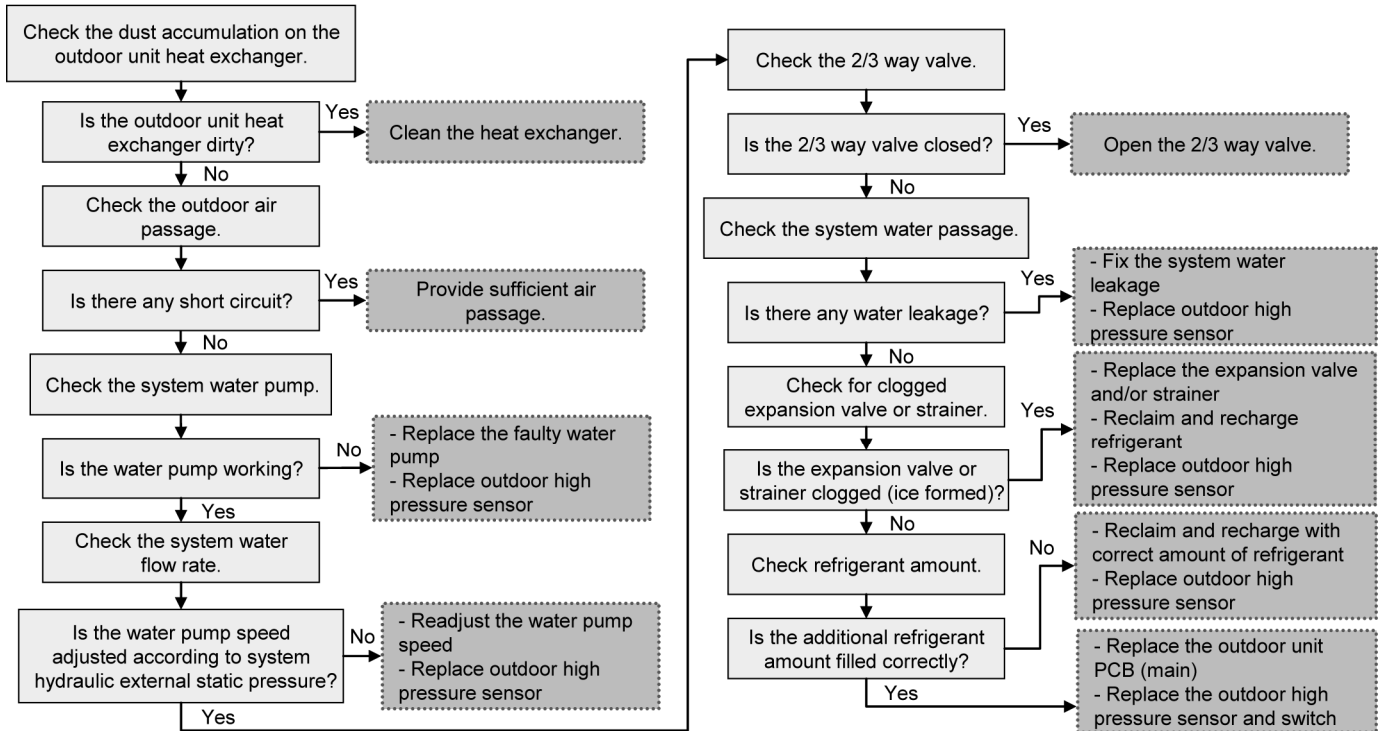



## 19.5.28 Compressor Rotation Failure (F14)

### Malfunction Decision Conditions:

A compressor rotation failure is detected by checking the compressor running condition through the position detection circuit.

### Malfunction Caused:

- 1 Compressor terminal disconnect.
- 2 Faulty outdoor unit PCB (main).
- 3 Faulty compressor.

### Abnormality Judgment:

Continue 4 times in 20 minutes.

## Troubleshooting:



**Caution**

For safety reason and to prevent component breakdown, always switch off the power before remove and connect the component.

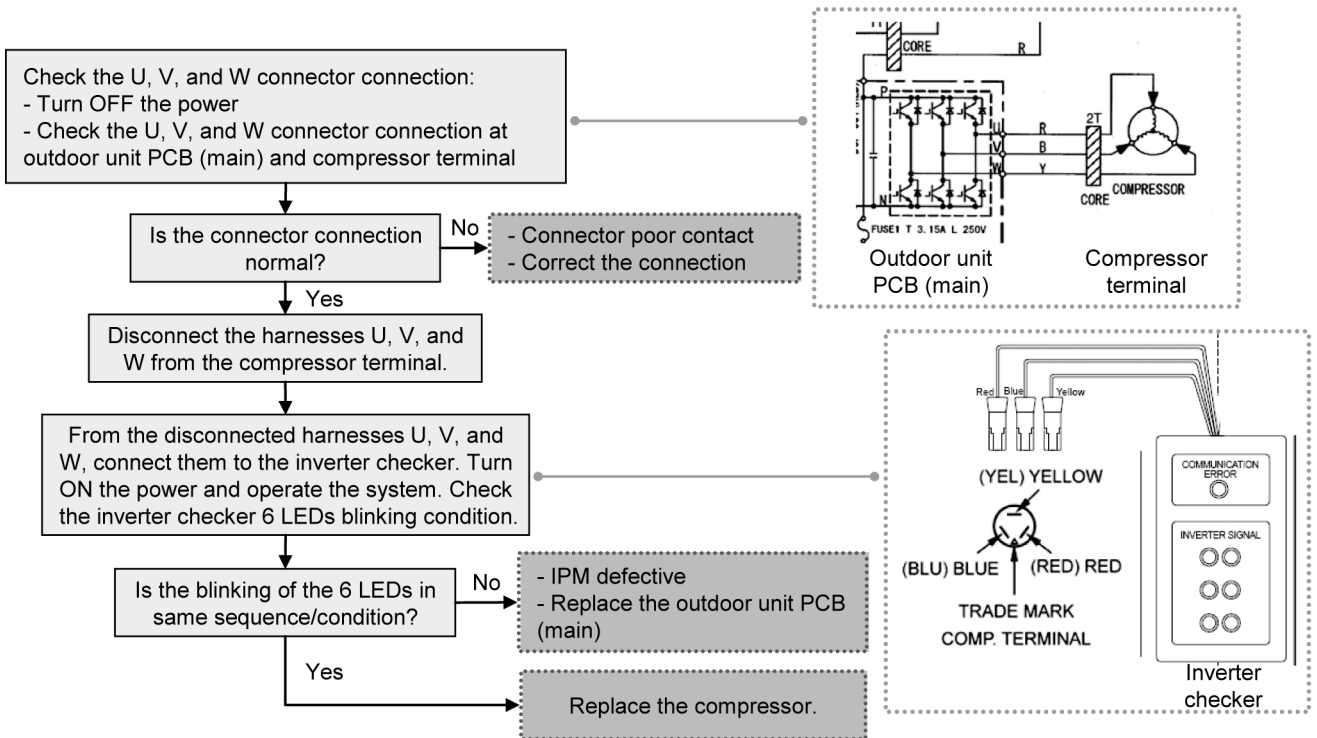

## 19.5.29 Outdoor Fan Motor (DC Motor) Mechanism Locked (F15)

### Malfunction Decision Conditions:

The rotation speed detected by the Hall IC of the fan motor during fan motor operation is used to determine abnormal fan motor (feedback of rotation > 2550 rpm or < 50 rpm).

### Malfunction Caused:

- 1 Operation stop due to short circuit inside the fan motor winding.
- 2 Operation stop due to breaking of wire inside the fan motor.
- 3 Operation stop due to breaking of fan motor lead wires.
- 4 Operation stop due to fan motor Hall IC malfunction.
- 5 Operation error due to faulty outdoor unit PCB.

### Abnormality Judgment:

Continue 2 times in 30 minutes.

### Troubleshooting:



For safety reason and to prevent component breakdown, always switch off the power before remove and connect the component.

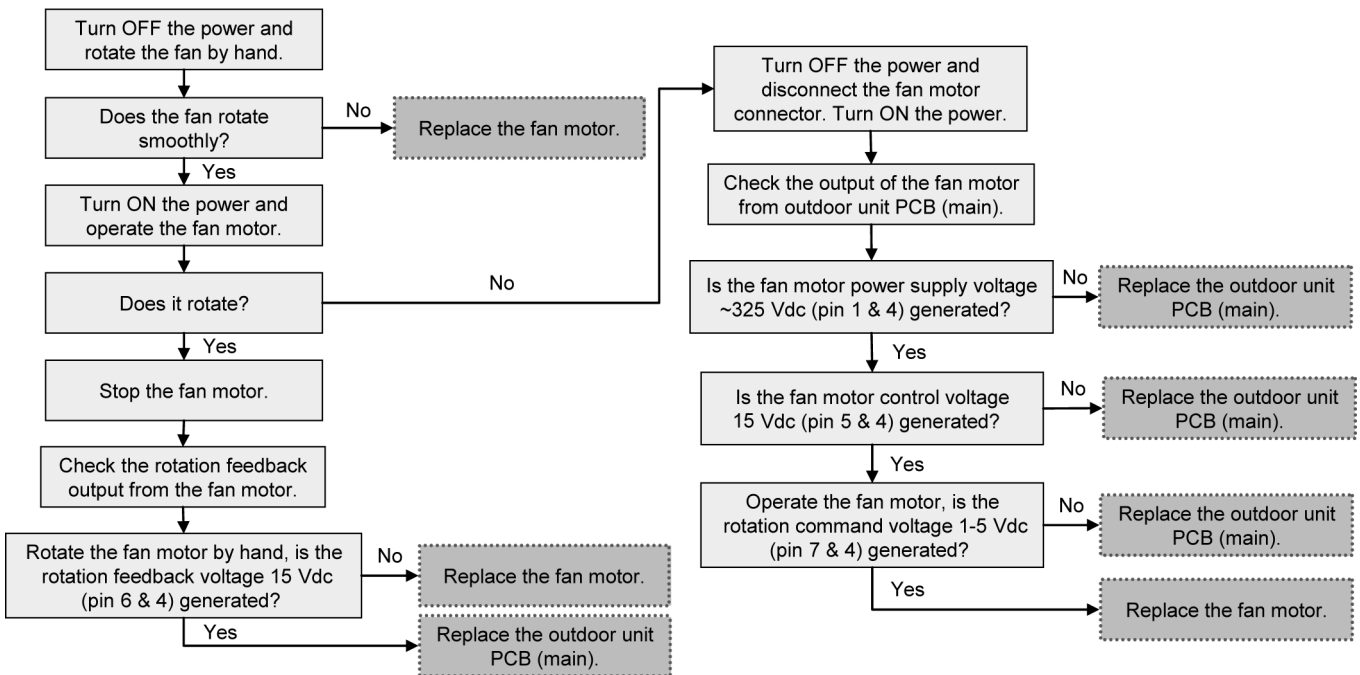

### 19.5.30 Input Over Current Detection (F16)

#### Malfunction Decision Conditions:

During operation of cooling and heating, when outdoor current above 14.8 A (MDC05J3E5), 27.9 A (MDC07J3E5, MDC09J3E5) is detected by the current transformer (CT) in the outdoor unit PCB.

#### Malfunction Caused:

- 1 Excessive refrigerant.
- 2 Faulty outdoor unit PCB (main).

#### Abnormality Judgment:

Continue 3 times in 20 minutes.

#### Troubleshooting: Caution

For safety reason and to prevent component breakdown, always switch off the power before remove and connect the component.

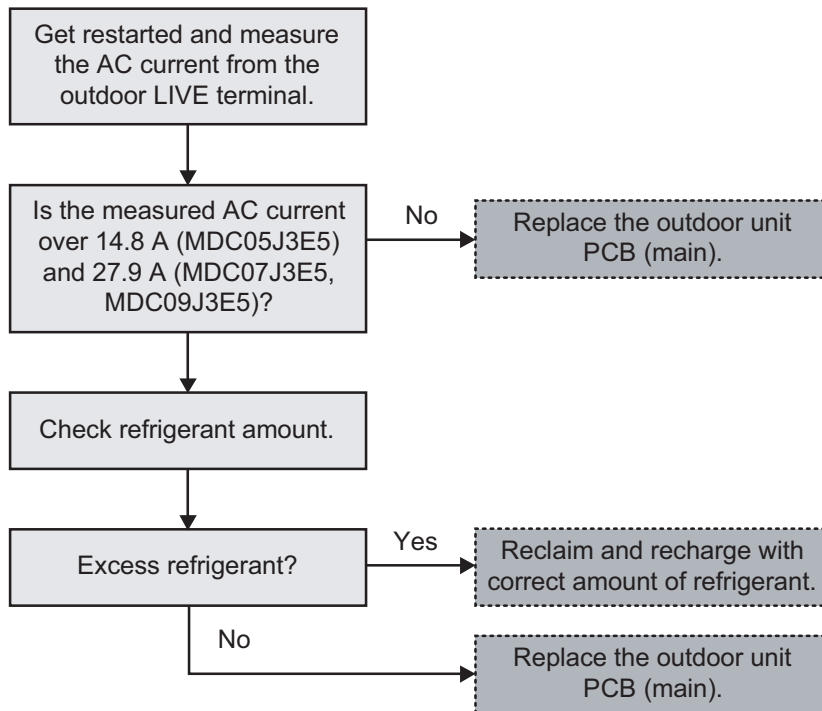

## 19.5.31 Compressor Overheating (F20)

### Malfunction Decision Conditions:

During operation of cooling and heating, when temperature above 112°C is detected by the compressor tank temperature sensor.

### Malfunction Caused:

- 1 Faulty compressor tank temperature sensor.
- 2 2/3 way valve closed.
- 3 Refrigerant shortage (refrigerant leakage).
- 4 Clogged expansion valve or strainer.
- 5 Faulty outdoor unit PCB (main).
- 6 Faulty compressor.

### Abnormality Judgment:

Continue 4 times in 30 minutes.

## Troubleshooting:



**Caution**

For safety reason and to prevent component breakdown, always switch off the power before remove and connect the component.

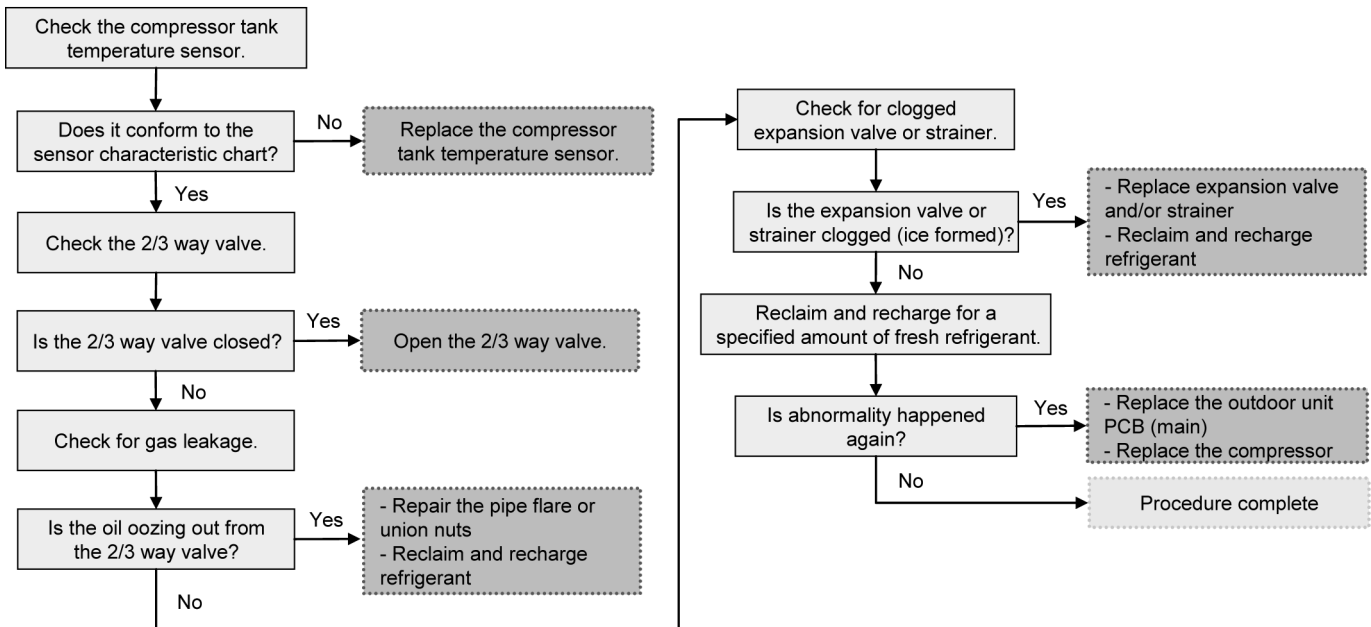

### 19.5.32 IPM Overheating (F22)

#### Malfunction Decision Conditions:

During operation of cooling and heating, when temperature 95°C is detected by the outdoor IPM temperature sensor.

#### Malfunction Caused:

- 1 Faulty outdoor unit fan motor.
- 2 Faulty outdoor unit PCB (main).

#### Abnormality Judgment:

Continue 3 times in 30 minutes.

### Troubleshooting:



For safety reason and to prevent component breakdown, always switch off the power before remove and connect the component.

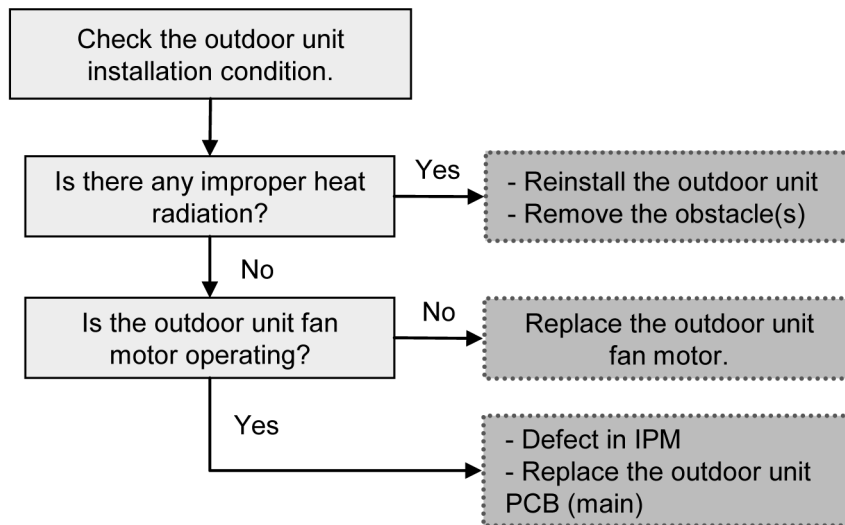

### 19.5.33 Output Over Current Detection (F23)

#### Malfunction Decision Conditions:

During operation of cooling and heating, when outdoor DC current is above 34 A is detected by the IPM DC Peak sensing circuitry in the outdoor unit PCB (main).

#### Malfunction Caused:

- 1 Faulty outdoor unit PCB (main).
- 2 Faulty compressor.

#### Abnormality Judgment:

Continue for 7 times.

### Troubleshooting:



**Caution**

For safety reason and to prevent component breakdown, always switch off the power before remove and connect the component.

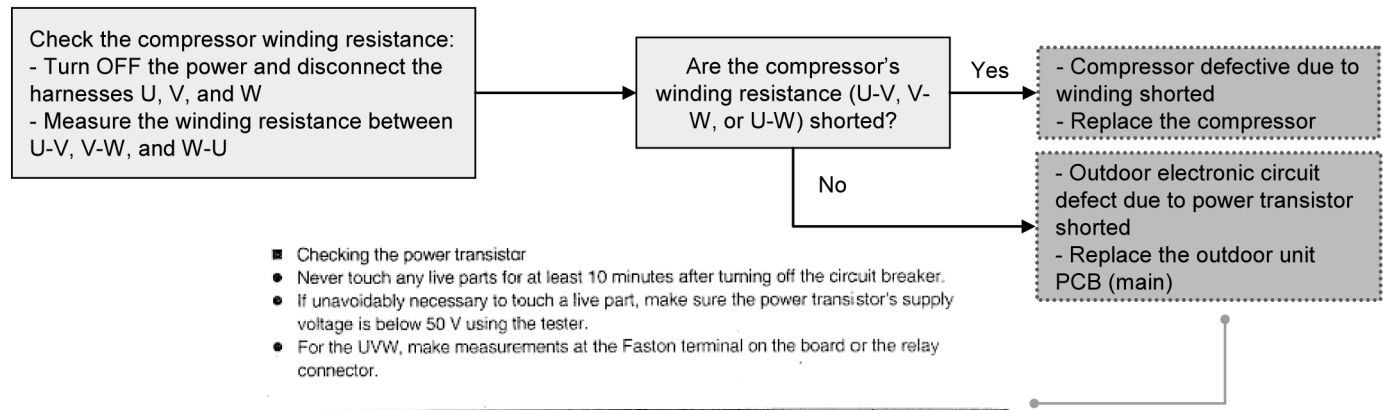

- Checking the power transistor
- Never touch any live parts for at least 10 minutes after turning off the circuit breaker.
- If unavoidably necessary to touch a live part, make sure the power transistor's supply voltage is below 50 V using the tester.
- For the UVW, make measurements at the Faston terminal on the board or the relay connector.

Tester's negative terminal	Power transistor (+)	UVW	Power transistor (-)	UVW
Tester's positive terminal	UVW	Power transistor (+)	UVW	Power transistor (-)
Normal resistance	Several kohms to several Mohms			
Abnormal resistance	0 or ∞			

### 19.5.34 Refrigeration Cycle Abnormality (F24) (WH-MDC05J3E5)

**Malfunction Decision Conditions:**

- 1 During operation of cooling and heating, compressor frequency > Frated.
- 2 During operation of cooling and heating, running current: 0.65 A < I < 1.65 A.
- 3 During operation of cooling, water inlet temperature - indoor refrigerant liquid temperature < 5°C.
- 4 During operation of heating, indoor refrigerant liquid temperature - water inlet temperature < 5°C.

**Malfunction Caused:**

- 1 Faulty water inlet or indoor refrigerant liquid temperature sensors.
- 2 2/3 way valve closed.
- 3 Refrigerant shortage (refrigerant leakage).
- 4 Clogged expansion valve or strainer.
- 5 Faulty outdoor unit PCB (main).
- 6 Poor compression of compressor.

**Abnormality Judgment:**

Continue 2 times in 20 minutes.

**Troubleshooting:**



For safety reason and to prevent component breakdown, always switch off the power before remove and connect the component.

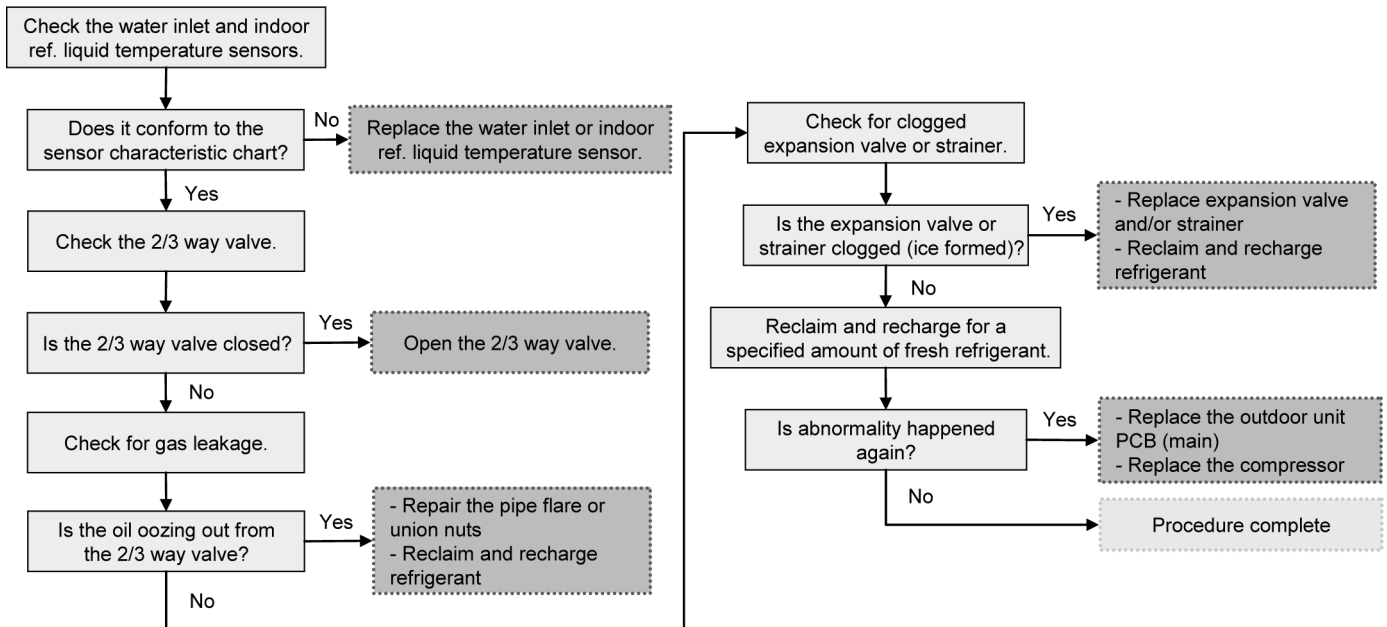

### 19.5.35 Refrigeration Cycle Abnormality (F24) (WH-MDC07J3E5 and WH-MDC09J3E5)

#### Malfunction Decision Conditions:

- 1 During operation running (heating / cooling) for more than 10 minutes expect deice, pumpdown and test mode.
- 2 During heating / cooling, water outlet and water inlet difference is less than 1°C.
- 3 During heating / cooling, high pressure < 1MPa (143 Psi) for more than 10 minutes or < 0.2 MPa (28 Psi) for more than 5 minutes.
- 4 During heating / cooling, discharge temperature - saturation temperature of high pressure  $\geq 60^{\circ}\text{C}$ .

#### Malfunction Caused:

- 1 Refrigerant shortage (refrigerant leakage).
- 2 Faulty indoor water inlet, indoor water outlet, compressor discharge temp sensor or high pressure sensor.
- 3 2/3 way valve closed.
- 4 Clogged expansion valve or strainer.
- 5 Faulty outdoor unit PCB (main).

#### Abnormality Judgment:

Continue 2 times in 20 minutes.

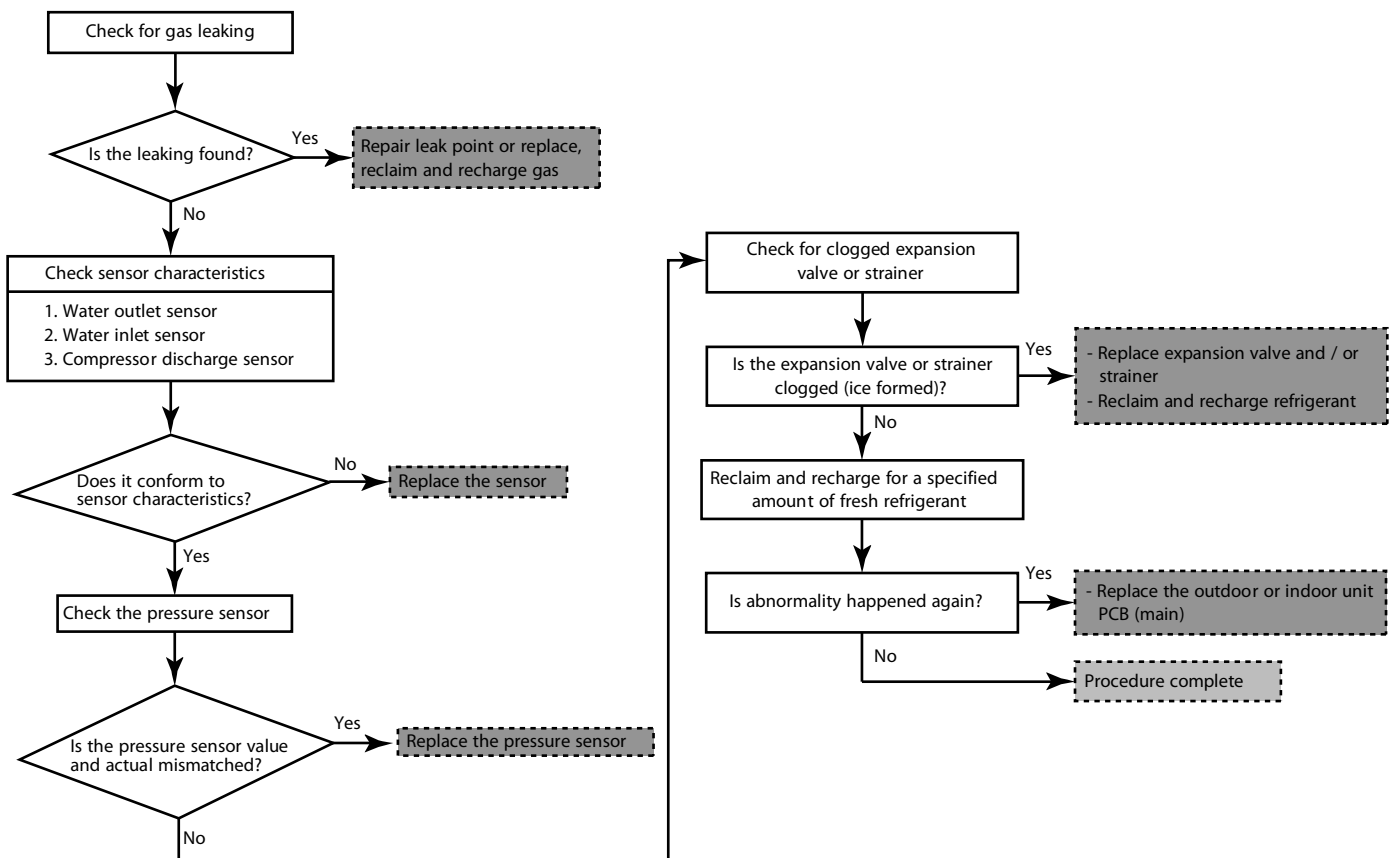



### 19.5.36 Four Way Valve Abnormality (F25)

**Malfunction Decision Conditions:**

- 1 During heating operation, when the indoor pipe temperature of thermostat ON indoor unit < 0°C.
- 2 During cooling operation, when the indoor pipe temperature of thermostat ON indoor unit > 45°C.

**Malfunction Caused:**

- 1 Faulty sensor.
- 2 Faulty connector connection.
- 3 Faulty outdoor unit PCB (noise filter/main).
- 4 Faulty four way valve.

**Abnormality Judgment:**

Continue 4 times in 30 minutes.

**Troubleshooting:**



**Caution**

For safety reason and to prevent component breakdown, always switch off the power before remove and connect the component.

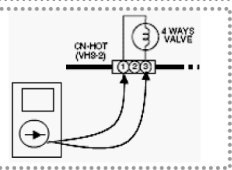
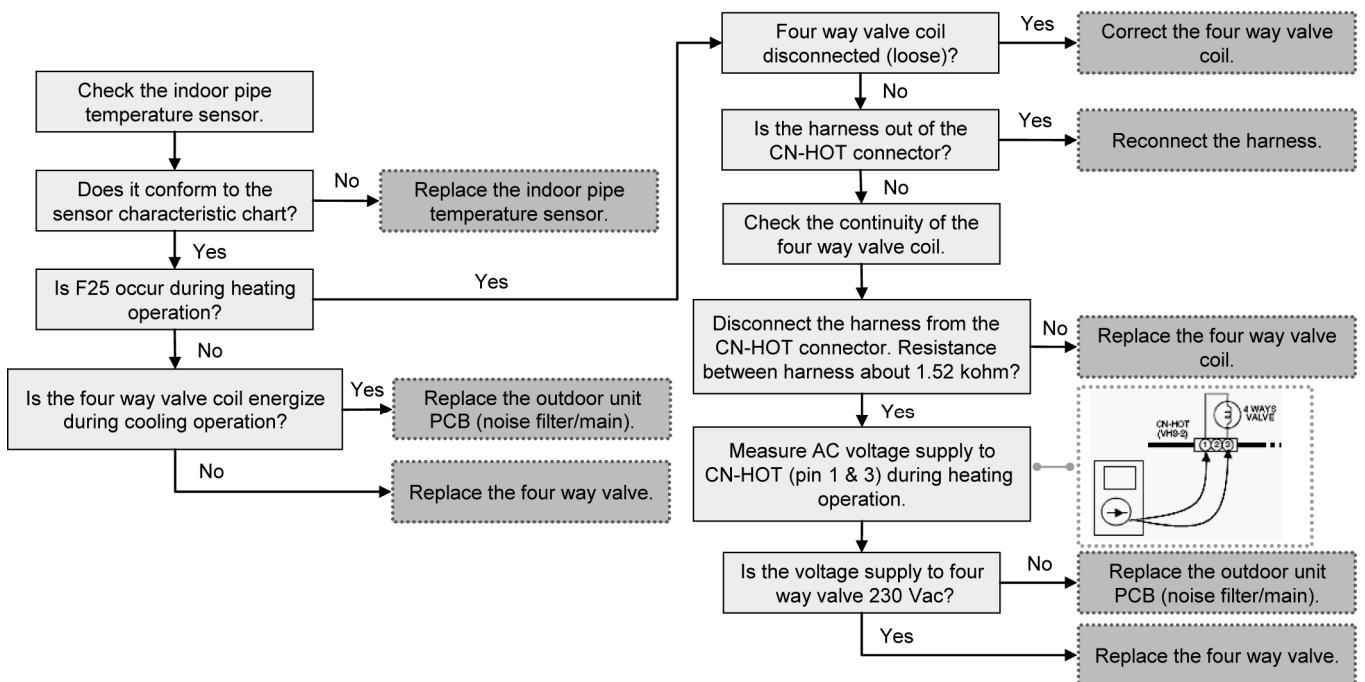

## 19.5.37 Outdoor High Pressure Switch Abnormal (F27)

### Malfunction Decision Conditions:

During compressor stop, and outdoor high pressure switch is remain opened.

### Malfunction Caused:

- 1 Faulty connector connection.
- 2 Faulty switch.
- 3 Faulty outdoor unit PCB (main).

### Abnormality Judgment:

Continue for 1 minute.

## Troubleshooting:



**Caution**

For safety reason and to prevent component breakdown, always switch off the power before remove and connect the component.

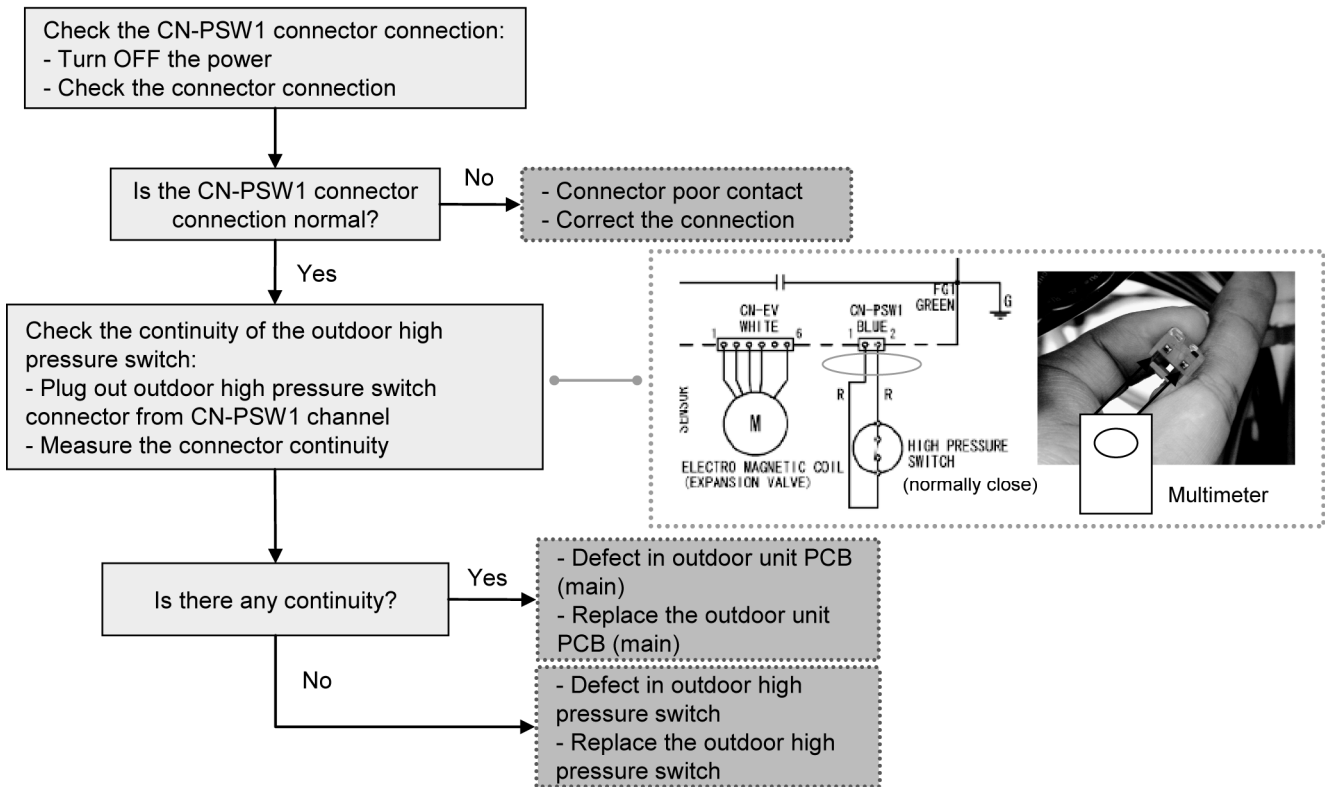

### 19.5.38 Low Discharge Superheat (F29)

**Malfunction Decision Conditions:**

During startup and operation of cooling and heating, the temperatures detected by the outdoor pipe temperature sensor are used to determine sensor error.

**Malfunction Caused:**

- 1 Faulty connector connection.
- 2 Faulty sensor.
- 3 Faulty outdoor unit PCB (main).
- 4 Faulty High Pressure Switch
- 5 Refrigerant shortage (refrigerant leakage).

**Abnormality Judgment:**

1 times occurrence within 2550 minutes.

**Troubleshooting:**



For safety reason and to prevent component breakdown, always switch off the power before remove and connect the component.

Check the CN-DIS & CN-TH1 connection:  
 - Turn OFF the power.  
 - Check the connector connection.

- Is the CN-DIS & CN-TH1 connector normal?  
 - Measured the resistance of the sensor, is the measured resistance matches the value specified in its characteristic chart?

No

- Replace the temperature Sensor.

Yes

Check Refrigeration Cycle Pressure.

Is the refrigerant cycle pressure normal?

No

- Recharge Gas.

Yes

- Defect in Outdoor Unit PCB.  
 - Replace the Outdoor Unit PCB.

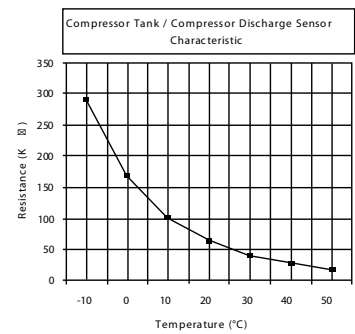
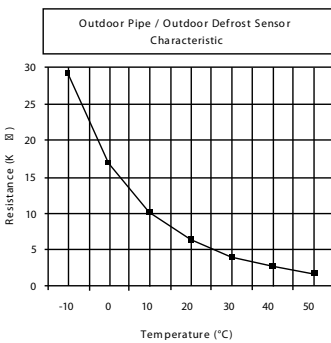

## 19.5.39 Indoor Water Outlet Temperature Sensor 2 Abnormality (F30)

### Malfunction Decision Conditions:

During startup and operation of cooling and heating, the temperatures detected by the indoor water outlet temperature sensor 2 are used to determine sensor error.

### Malfunction Caused:

- 6 Faulty connector connection.
- 7 Faulty sensor.
- 8 Faulty indoor unit PCB.

### Abnormality Judgment:

Continue for 5 seconds.

### Troubleshooting:



**Caution**

For safety reason and to prevent component breakdown, always switch off the power before remove and connect the component.

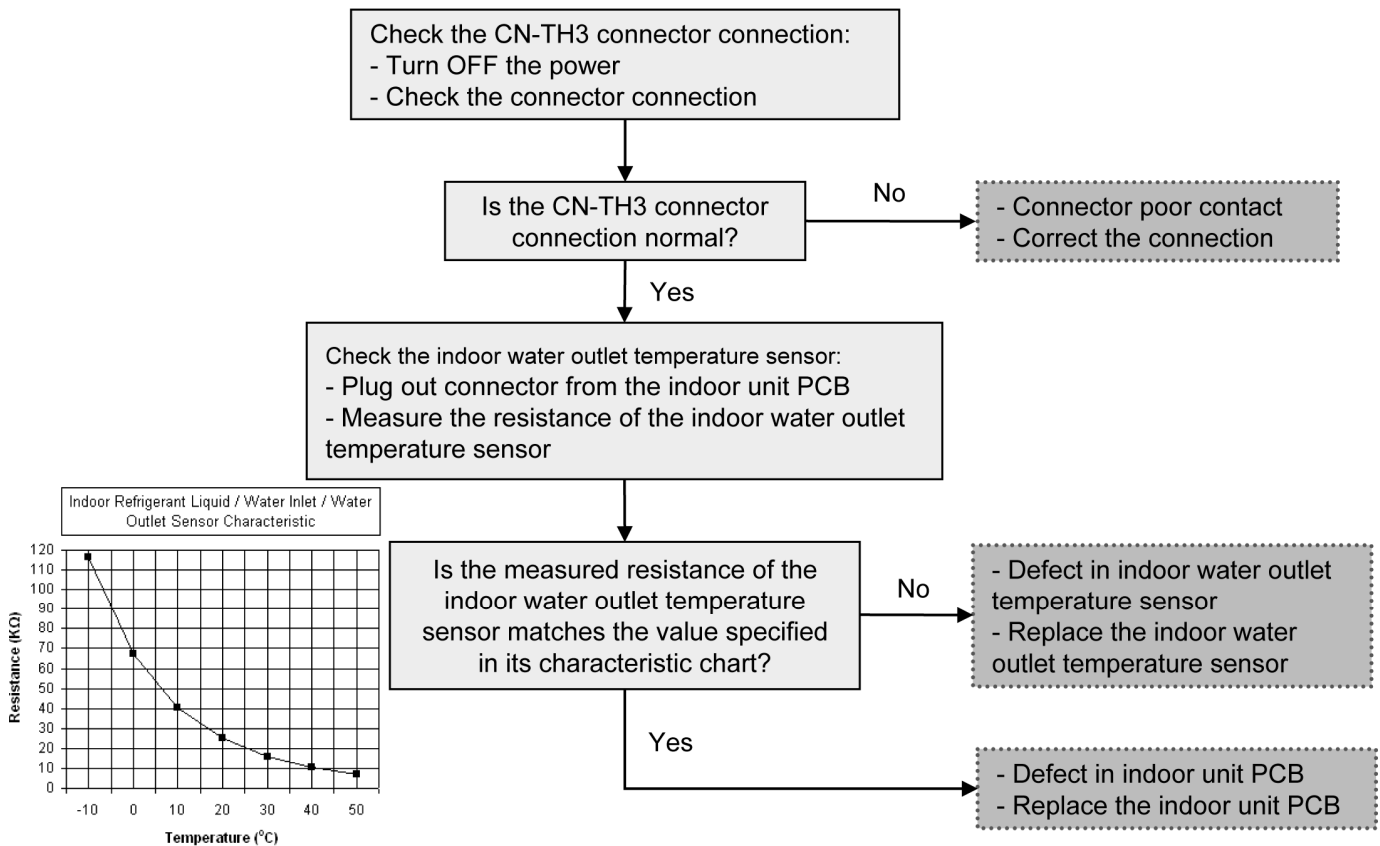

## 19.5.40 Outdoor Air Temperature Sensor Abnormality (F36)

### Malfunction Decision Conditions:

During startup and operation of cooling and heating, the temperatures detected by the outdoor air temperature sensor are used to determine sensor error.

### Malfunction Caused:

- 1 Faulty connector connection.
- 2 Faulty sensor.
- 3 Faulty outdoor unit PCB (main).

### Abnormality Judgment:

Continue for 5 seconds.

### Troubleshooting:



**Caution**

For safety reason and to prevent component breakdown, always switch off the power before remove and connect the component.

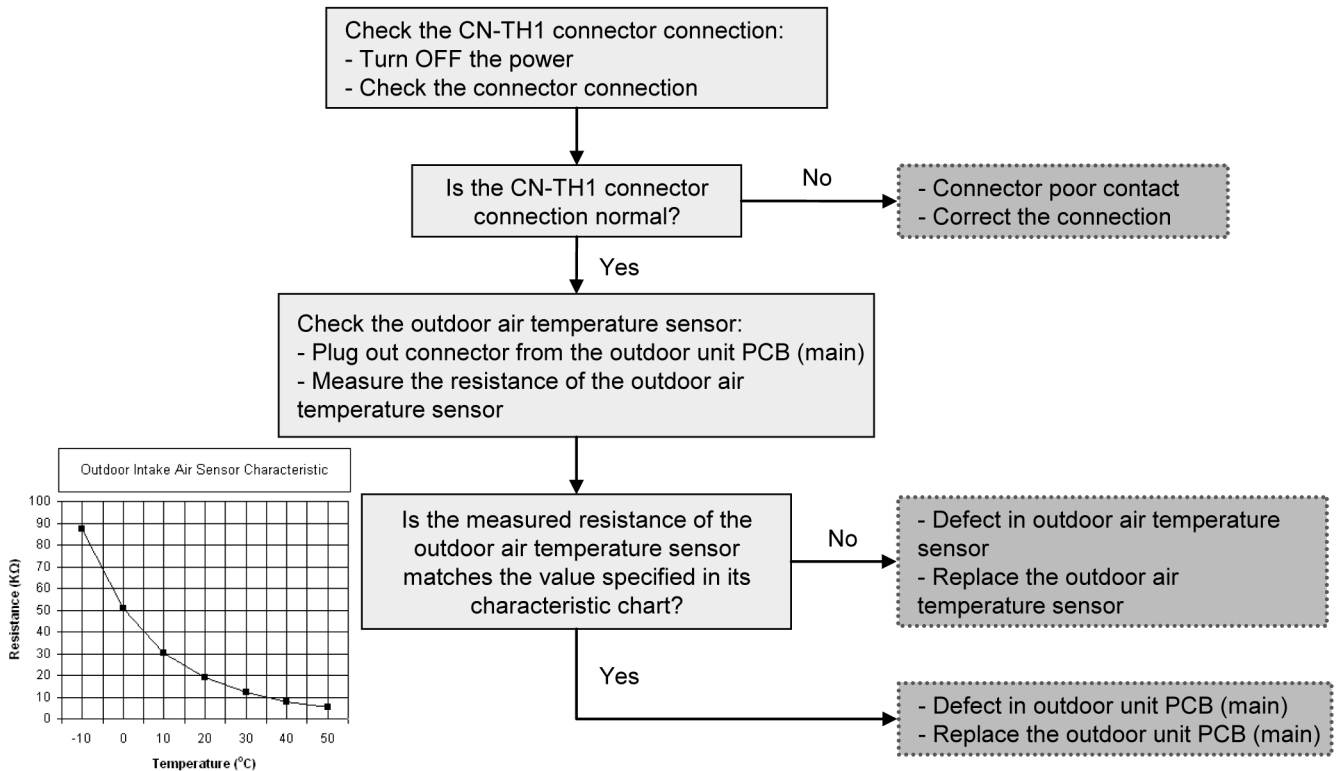

## 19.5.41 Indoor Water Inlet Temperature Sensor Abnormality (F37)

### Malfunction Decision Conditions:

During startup and operation of cooling and heating, the temperatures detected by the indoor water inlet temperature sensor are used to determine sensor error.

### Malfunction Caused:

- 1 Faulty connector connection.
- 2 Faulty sensor.
- 3 Faulty indoor unit PCB (main).

### Abnormality Judgment:

Continue for 5 seconds.

## Troubleshooting:



**Caution**

For safety reason and to prevent component breakdown, always switch off the power before remove and connect the component.

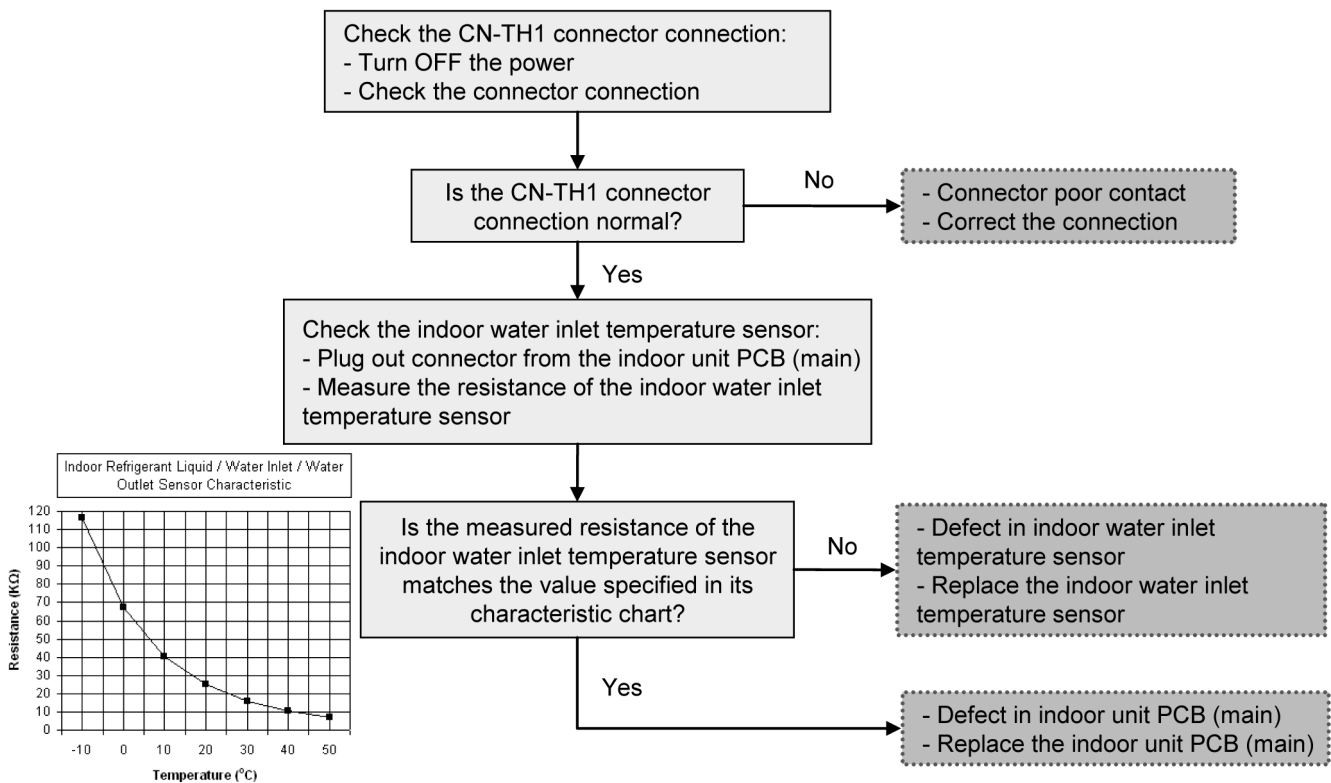

## 19.5.42 Outdoor Discharge Pipe Temperature Sensor Abnormality (F40)

### Malfunction Decision Conditions:

During startup and operation of cooling and heating, the temperatures detected by the outdoor discharge pipe temperature sensor are used to determine sensor error.

### Malfunction Caused:

- 1 Faulty connector connection.
- 2 Faulty sensor.
- 3 Faulty outdoor unit PCB (main).

### Abnormality Judgment:

Continue for 5 seconds.

### Troubleshooting:



**Caution**

For safety reason and to prevent component breakdown, always switch off the power before remove and connect the component.

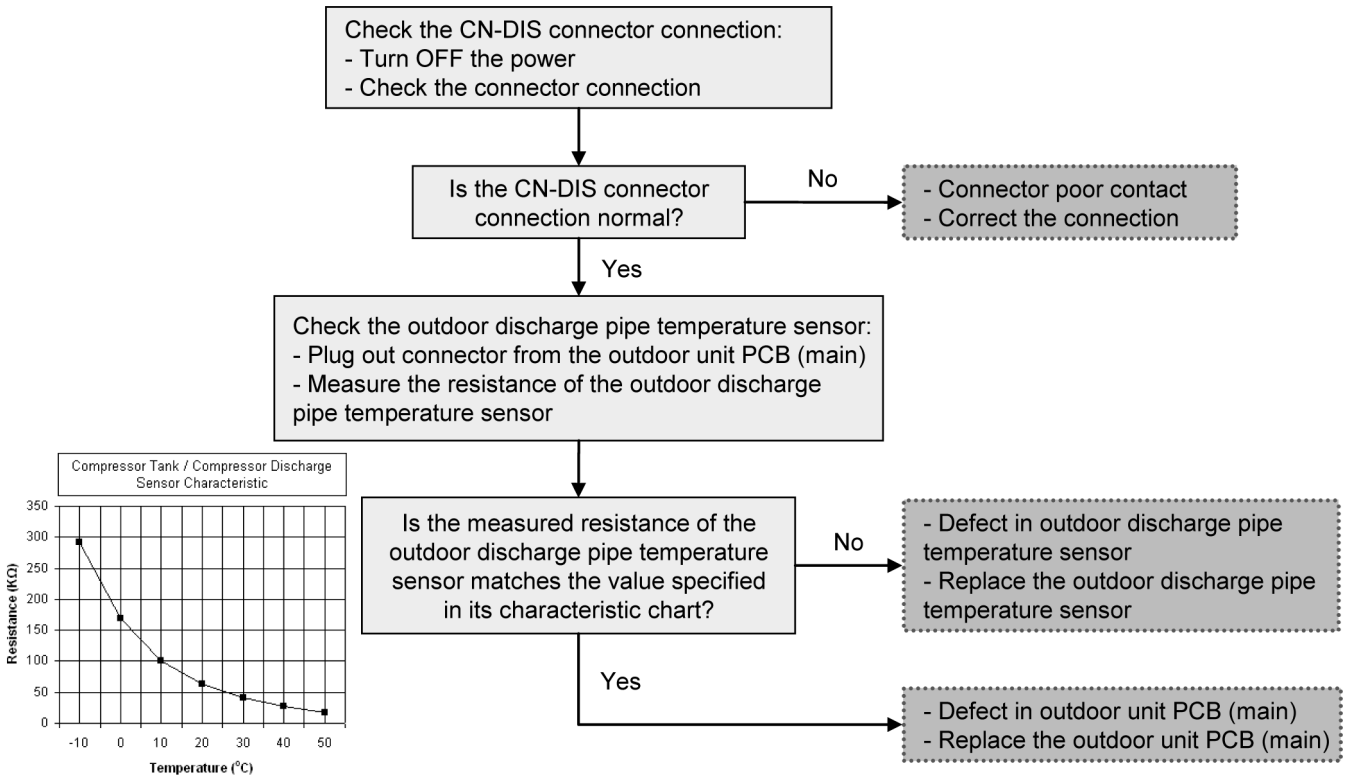

### 19.5.43 Power Factor Correction (PFC) Abnormality (F41)

**Malfunction Decision Conditions:**

During operation of cooling and heating, when the PFC protection circuitry in the outdoor unit PCB (main) senses abnormal high DC voltage level.

**Malfunction Caused:**

- 1 Power supply surge.
- 2 Compressor windings not uniform.
- 3 Faulty outdoor unit PCB (main).

**Abnormality Judgment:**

Continue 4 times in 10 minutes.

**Troubleshooting:**



**Caution**

For safety reason and to prevent component breakdown, always switch off the power before remove and connect the component.

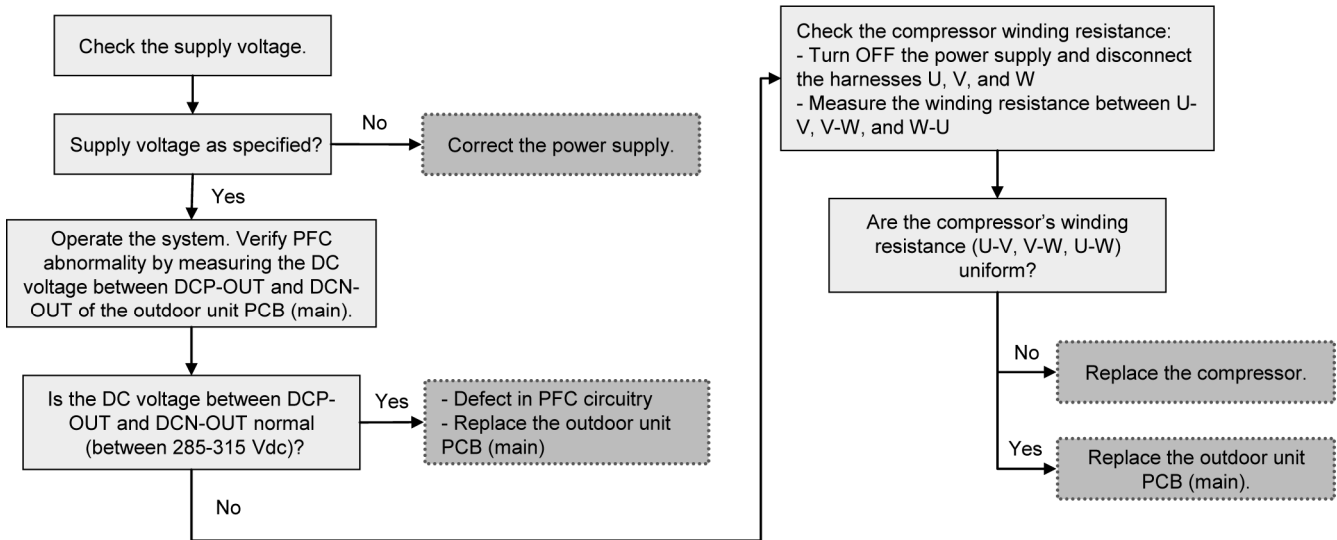



## 19.5.44 Outdoor Pipe Temperature Sensor Abnormality (F42)

### Malfunction Decision Conditions:

During startup and operation of cooling and heating, the temperatures detected by the outdoor pipe temperature sensor are used to determine sensor error.

### Malfunction Caused:

- 1 Faulty connector connection.
- 2 Faulty sensor.
- 3 Faulty outdoor unit PCB (main).

### Abnormality Judgment:

Continue for 5 seconds.

### Troubleshooting:



**Caution**

For safety reason and to prevent component breakdown, always switch off the power before remove and connect the component.

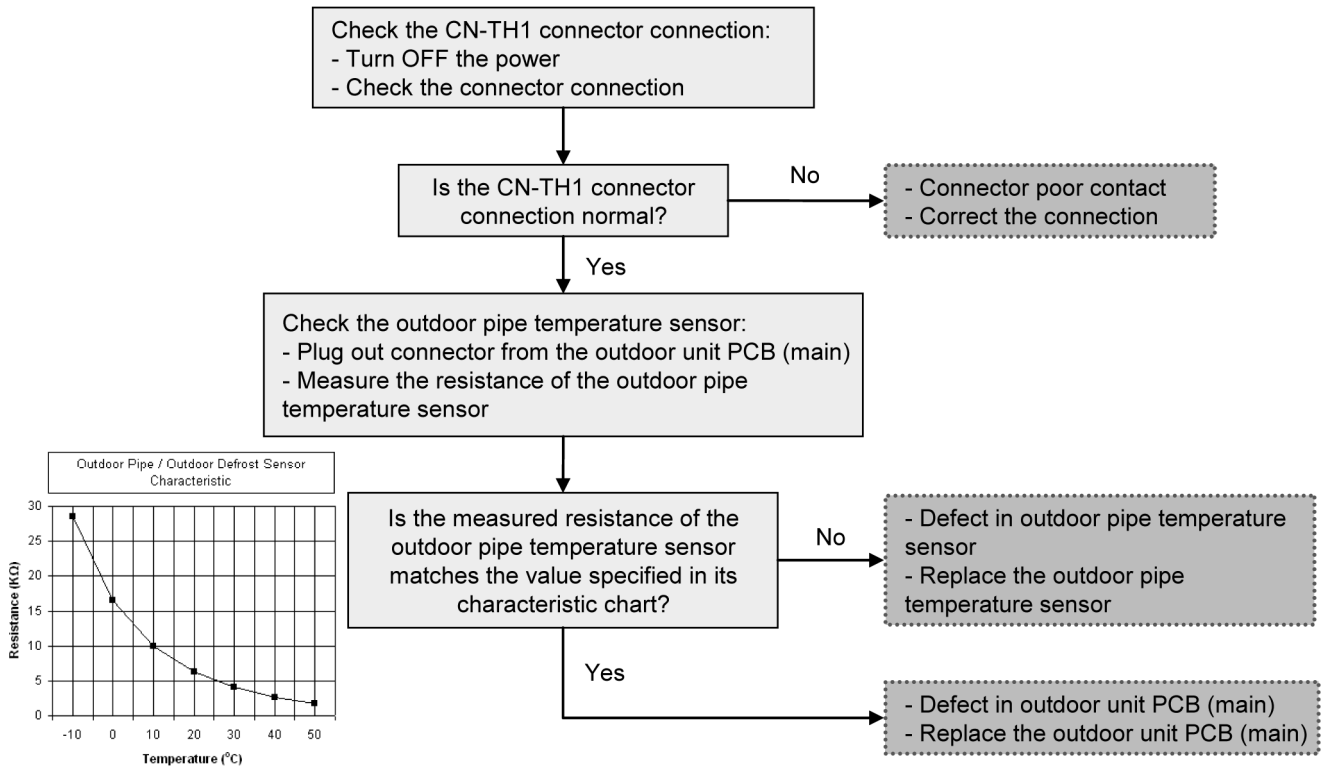

## 19.5.45 Outdoor Defrost Temperature Sensor Abnormality (F43)

### Malfunction Decision Conditions:

During startup and operation of cooling and heating, the temperatures detected by the outdoor defrost temperature sensor are used to determine sensor error.

### Malfunction Caused:

- 1 Faulty connector connection.
- 2 Faulty sensor.
- 3 Faulty outdoor unit PCB (main).

### Abnormality Judgment:

Continue for 5 seconds.

### Troubleshooting:



**Caution**

For safety reason and to prevent component breakdown, always switch off the power before remove and connect the component.

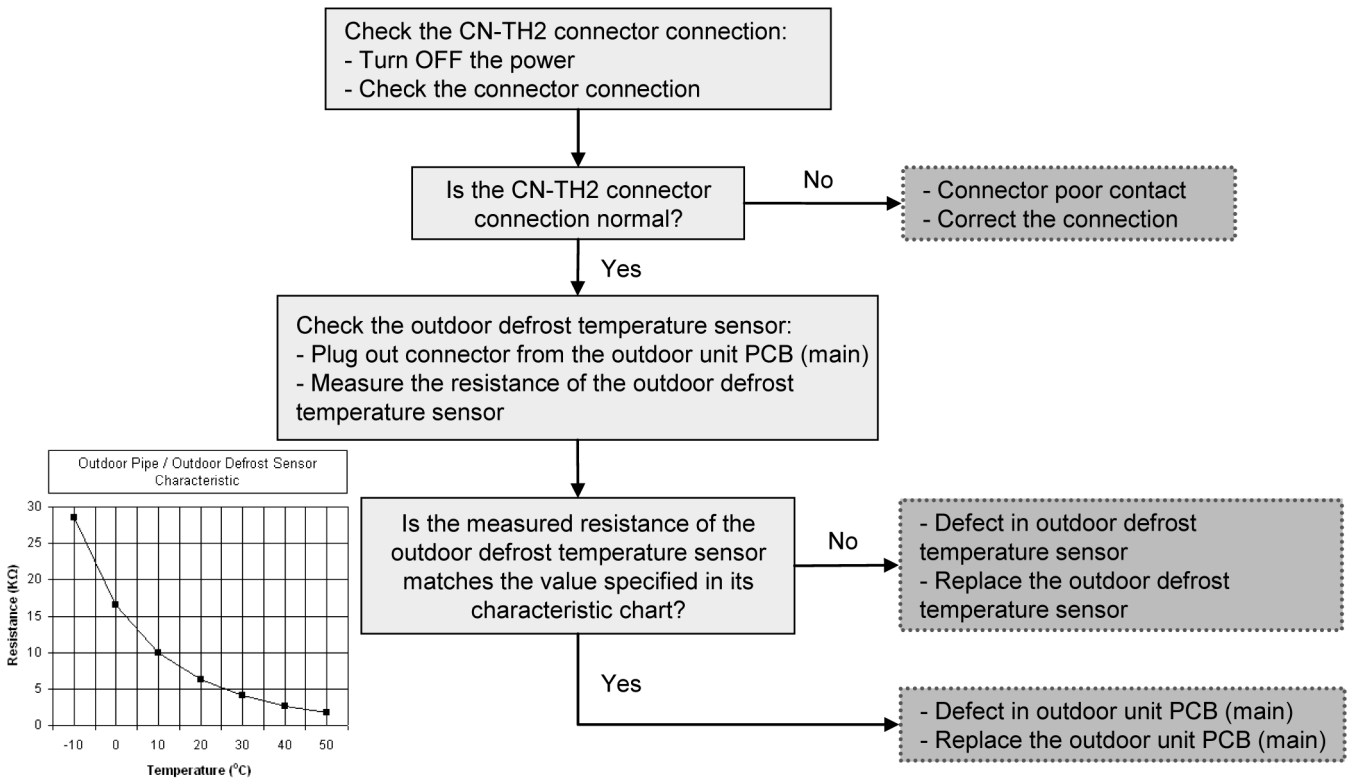

## 19.5.46 Indoor Water Outlet Temperature Sensor Abnormality (F45)

### Malfunction Decision Conditions:

During startup and operation of cooling and heating, the temperatures detected by the indoor water outlet temperature sensor are used to determine sensor errors.

### Malfunction Caused:

- 1 Faulty connector connection.
- 2 Faulty sensor.
- 3 Faulty indoor unit PCB (main).

### Abnormality Judgment:

Continue for 5 seconds.

### Troubleshooting:



**Caution**

For safety reason and to prevent component breakdown, always switch off the power before remove and connect the component.

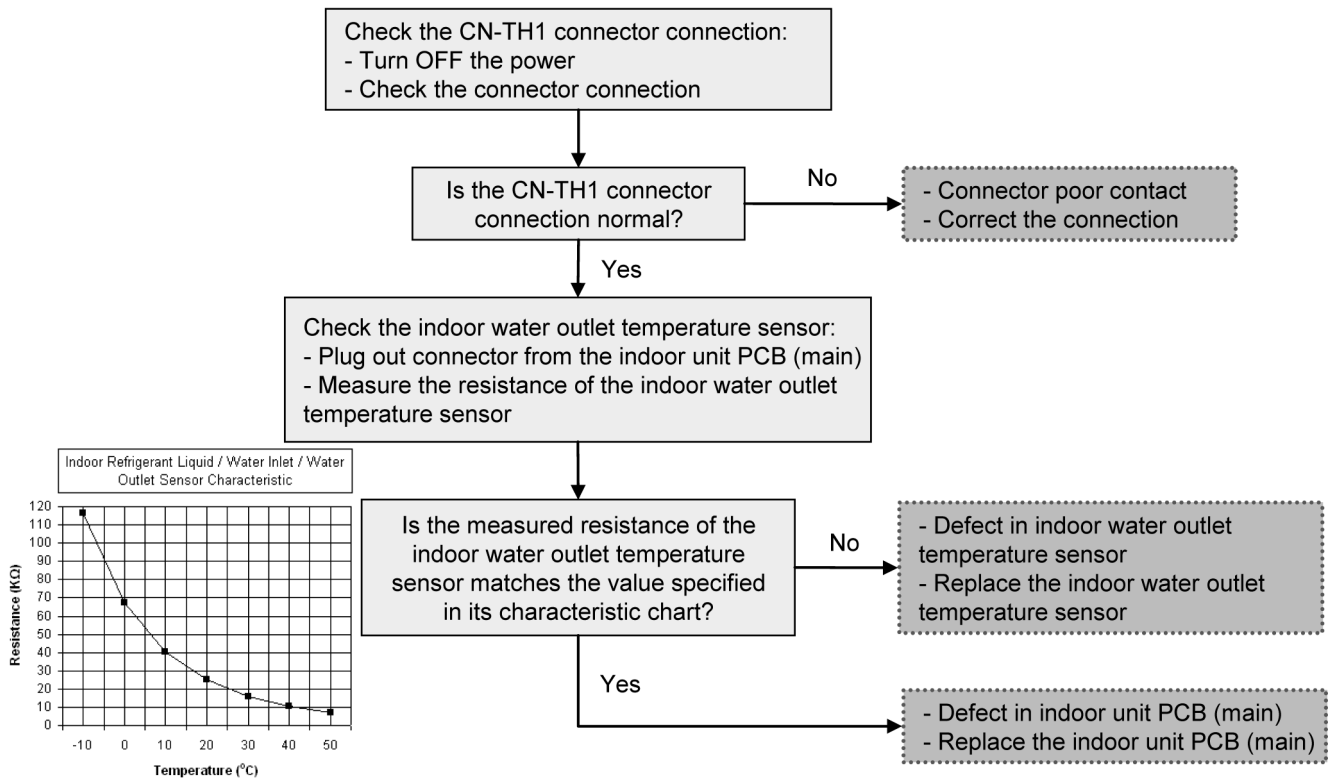

## 19.5.47 Outdoor Current Transformer Open Circuit (F46)

### Malfunction Decision Conditions:

A current transformer (CT) open circuit is detected by checking the compressor running frequency ( $\geq$  rated frequency) and CT detected input current ( $< 0.65$  A) for continuously 20 seconds.

### Malfunction Caused:

- 1 CT defective.
- 2 Faulty outdoor unit PCB (main).
- 3 Compressor defective (low compression).

### Abnormality Judgment:

Continue 3 times in 20 minutes.

## Troubleshooting:



For safety reason and to prevent component breakdown, always switch off the power before remove and connect the component.

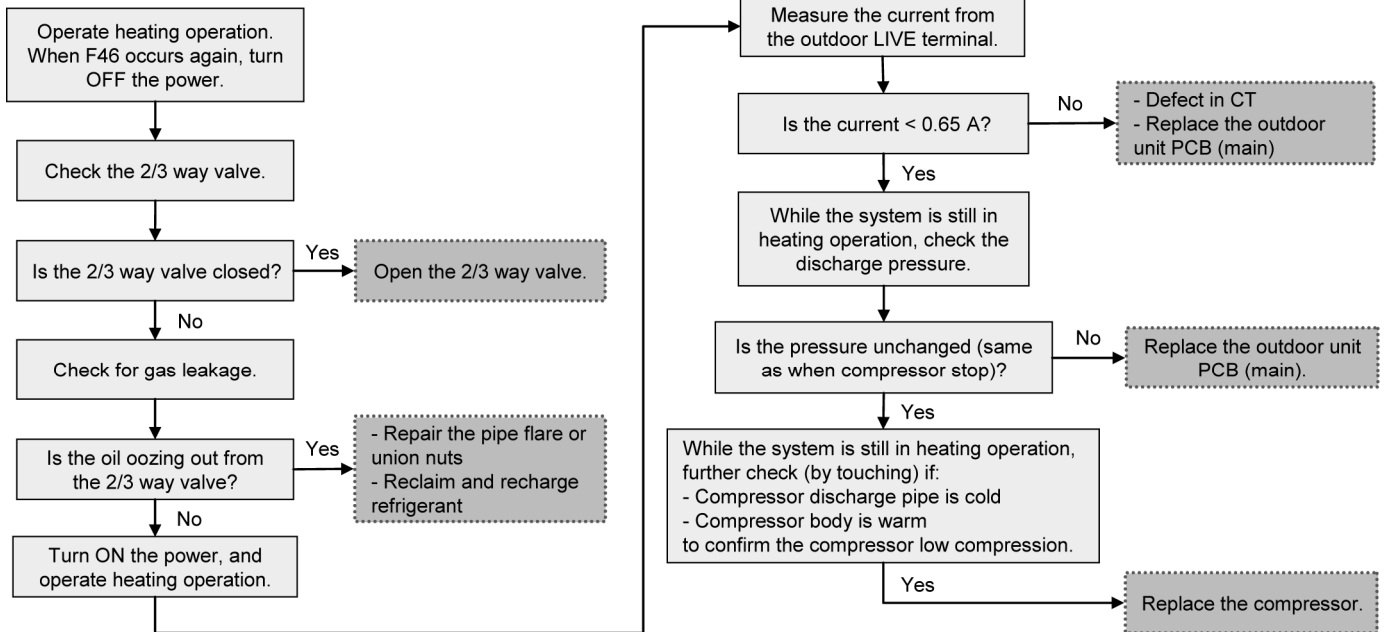

## 19.5.48 Cooling High Pressure Overload Protection (F95)

### Malfunction Decision Conditions:

During operation of cooling, when pressure 4.0 MPa and above is detected by outdoor high pressure sensor.

### Malfunction Caused:

- 1 Dust accumulation in the outdoor unit heat exchanger.
- 2 Air short circuit at outdoor unit.
- 3 2 way valve closed.
- 4 Faulty outdoor unit fan motor.
- 5 Clogged expansion valve or strainer.
- 6 Excessive refrigerant.
- 7 Faulty outdoor high pressure sensor.
- 8 Faulty outdoor unit PCB (main).

### Troubleshooting:



**Caution**

For safety reason and to prevent component breakdown, always switch off the power before remove and connect the component.

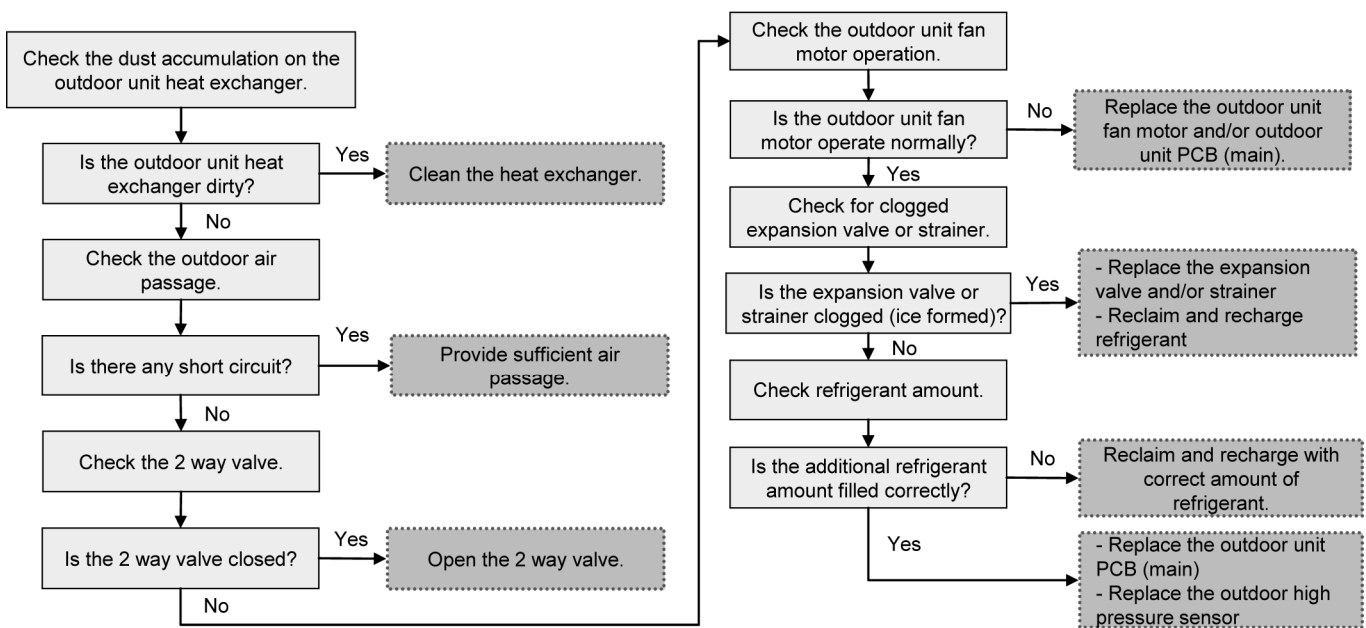

## 20. Disassembly and Assembly Instructions

 **WARNING**

High Voltage are generated in the electrical parts area by the capacitor. Ensure that the capacitor has discharged sufficiently before proceeding with repair work. Failure to heed this caution may result in electric shocks.

 **WARNING**

Be sure to switch off all the power supply before performing each of the below action.

### 20.1 To Remove The Cabinet Front Plate

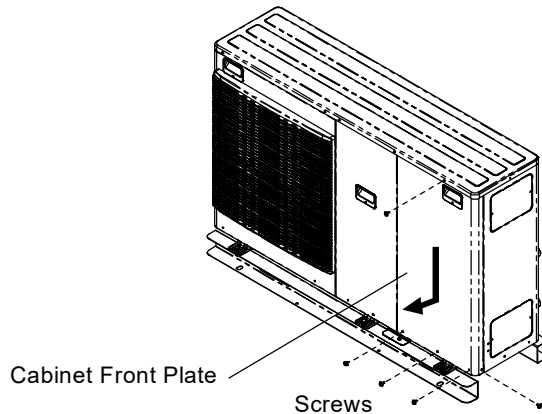

1. Remove 5 mounting screws.
2. Slide the cabinet front plate downward to release the pawls. Then, pull it toward front to remove it.

### 20.2 To Remove The Cabinet Top Plate

1. Remove the 12 mounting screws
2. Lift the cabinet top plate upward to remove it.

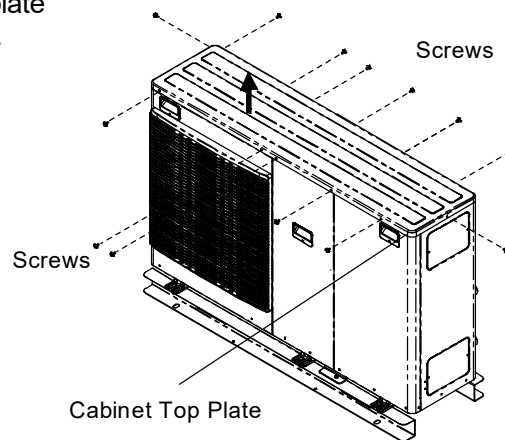

### 20.3 To Remove The Cabinet Rear Plate

4. Slide the cabinet rear plate downward to release the pawls. Then pull it out to remove it.
3. Remove 3 mounting screws.

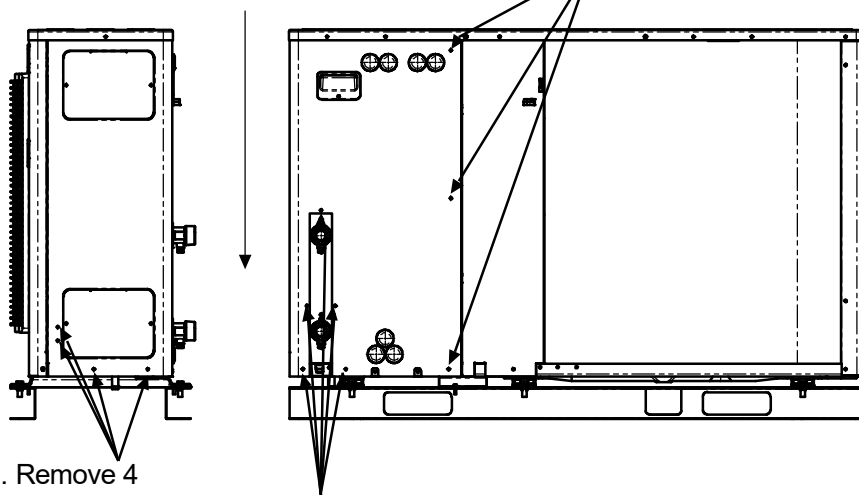

1. Remove 4 mounting screws.
2. Remove 5 mounting screws.

### 20.4 To Remove Pressure Gauge

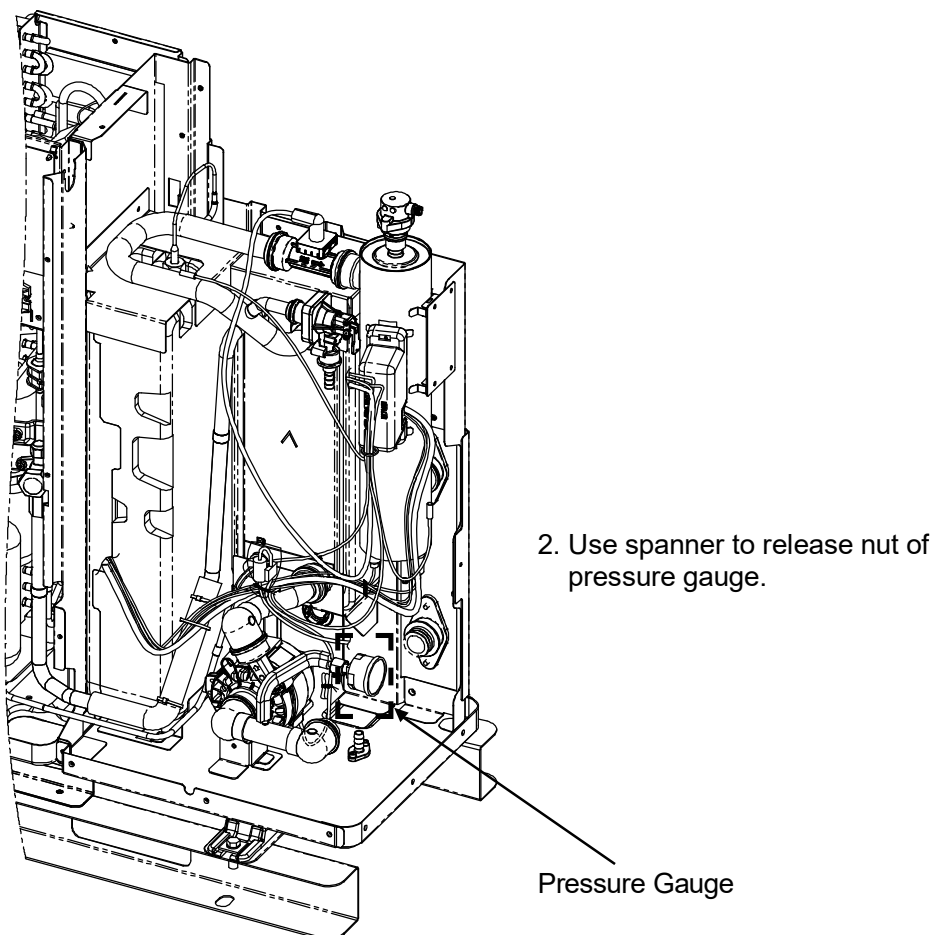

## 20.5 To Remove RCCB

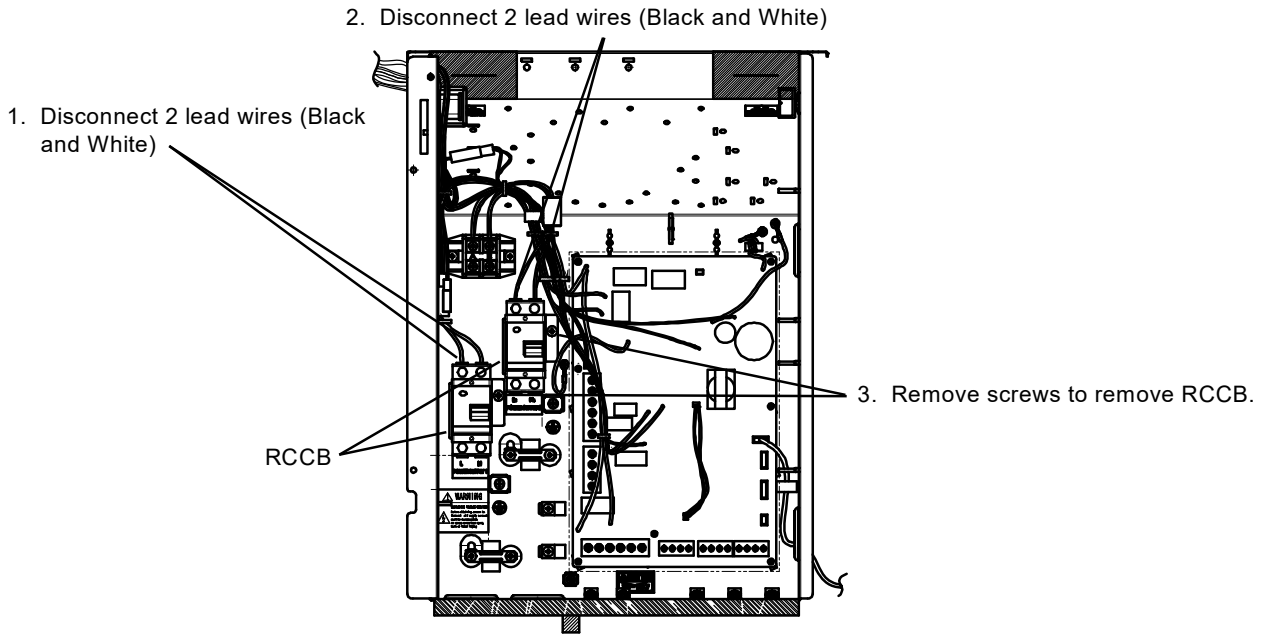

## 20.6 To Remove Reactor

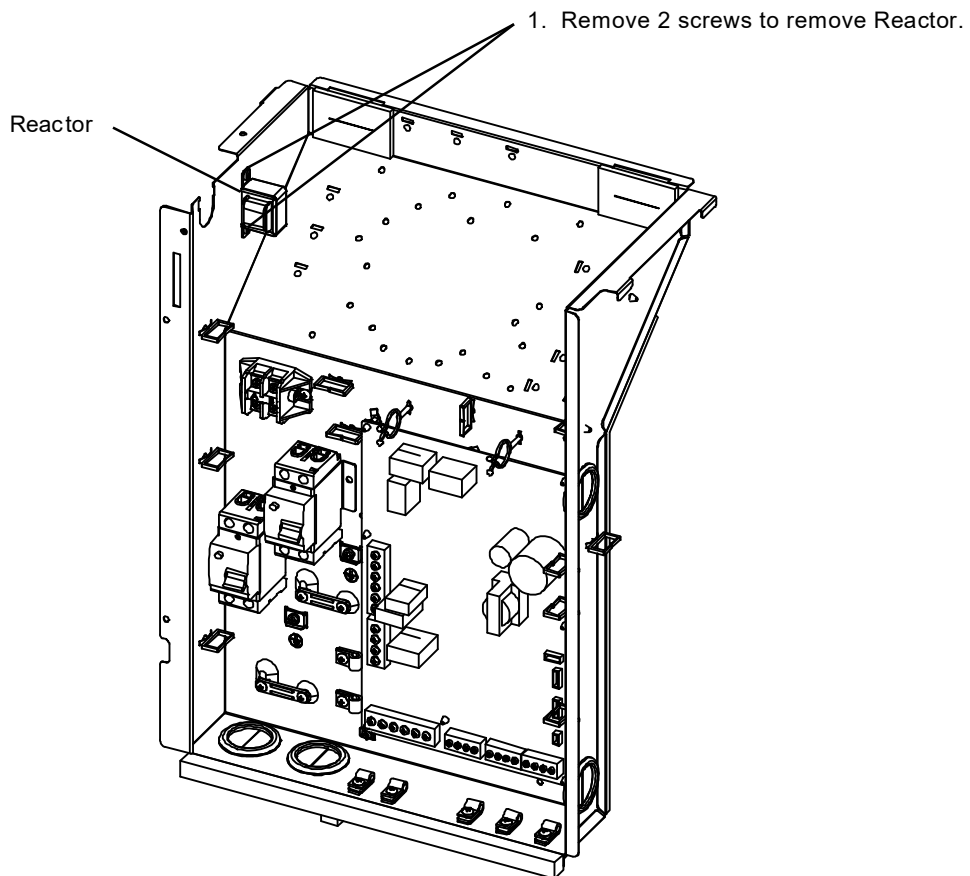



## 20.7 To Remove Water System Electronic Controller Board

1. Remove all the connectors from the Electronic Controller.

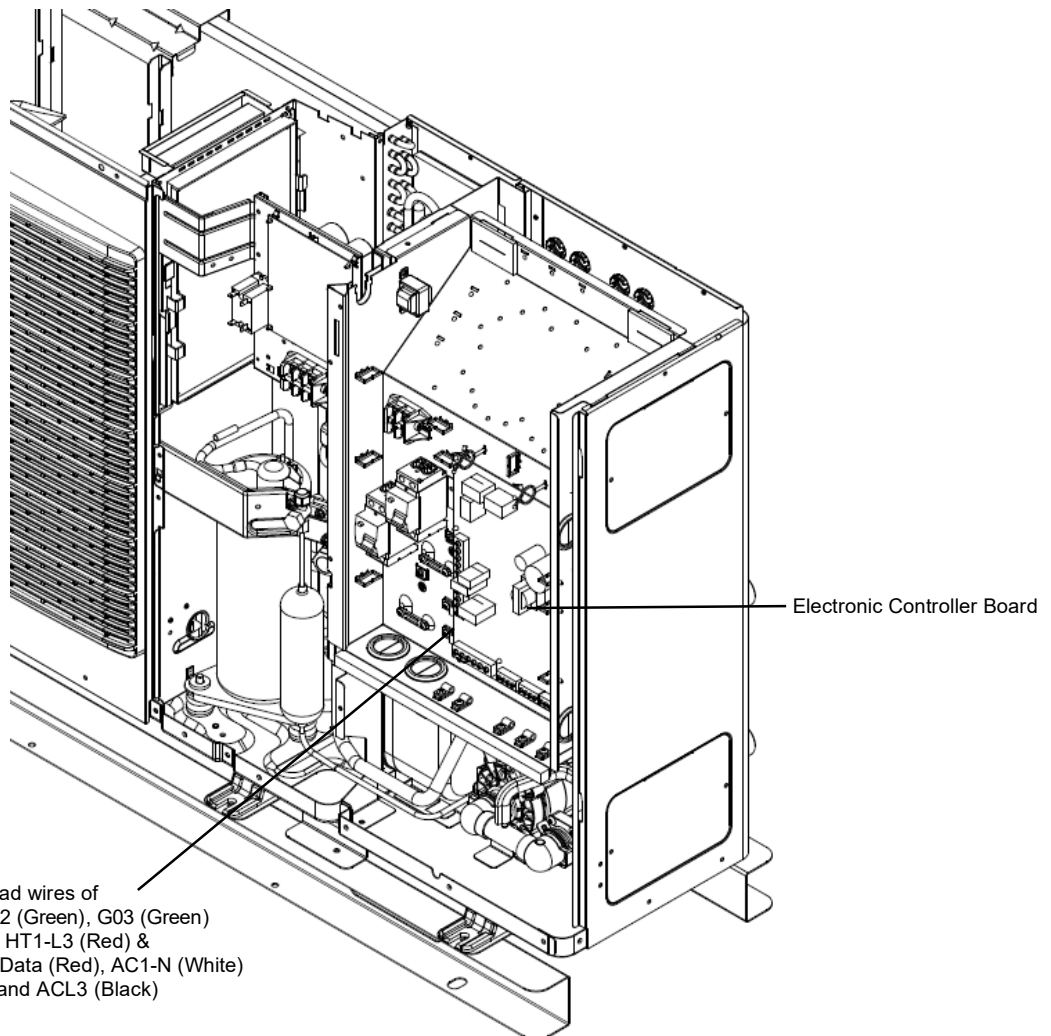
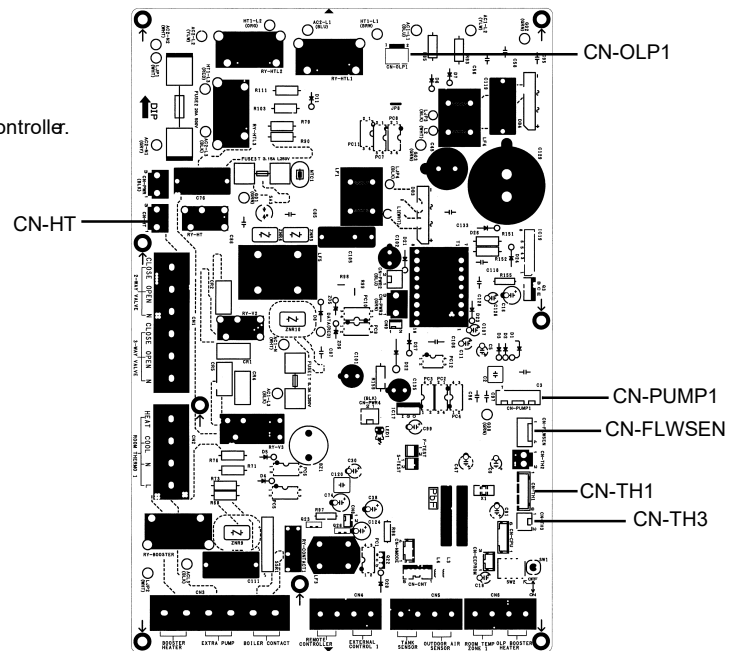

2. Disconnect all lead wires of  
G01 (Green), G02 (Green), G03 (Green)  
AC2-N2 (White), HT1-L3 (Red) &  
AC2-L3 (Black), Data (Red), AC1-N (White)  
AC1-L3 (Black) and ACL3 (Black)

## 20.8 To Remove Refrigerant Side Control Board Complete

3. Remove 2 screws to remove the Control Board Complete

1. Remove all lead wire FG1 (Green)  
AC-L (Grey), DCP (Red), DCN2 (Black),  
DCN (Black), AC-C (Blue), AC-BLK01 (Black),  
AC-BLK02 (Black), COM3 (Red), AC-WHT02 (White)  
and U (Red) V (Blue) W (Yellow) connector.

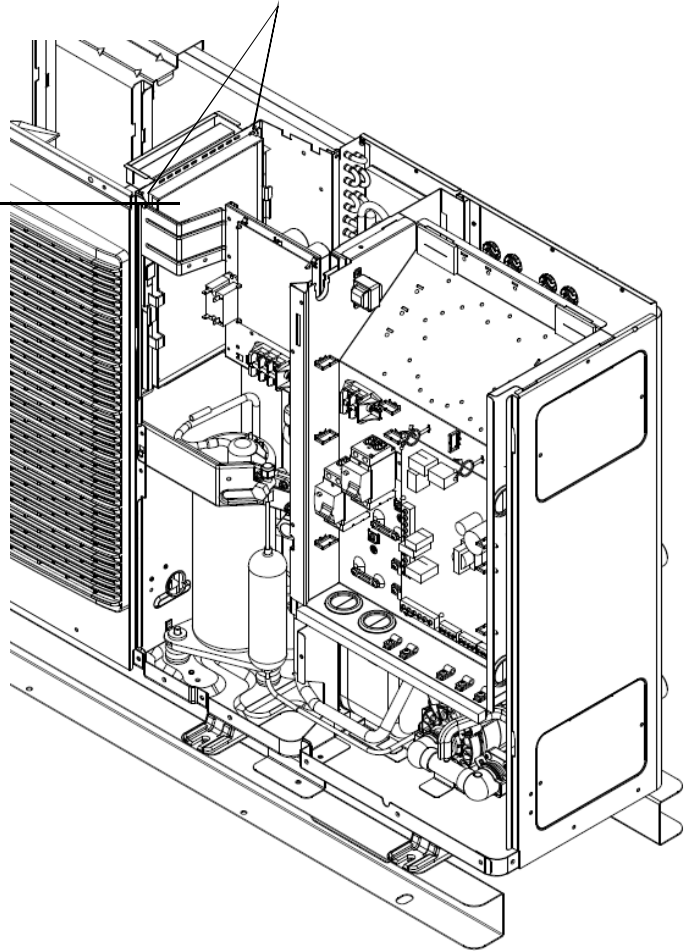

2. Disconnect all the connectors  
from the electronic control board.

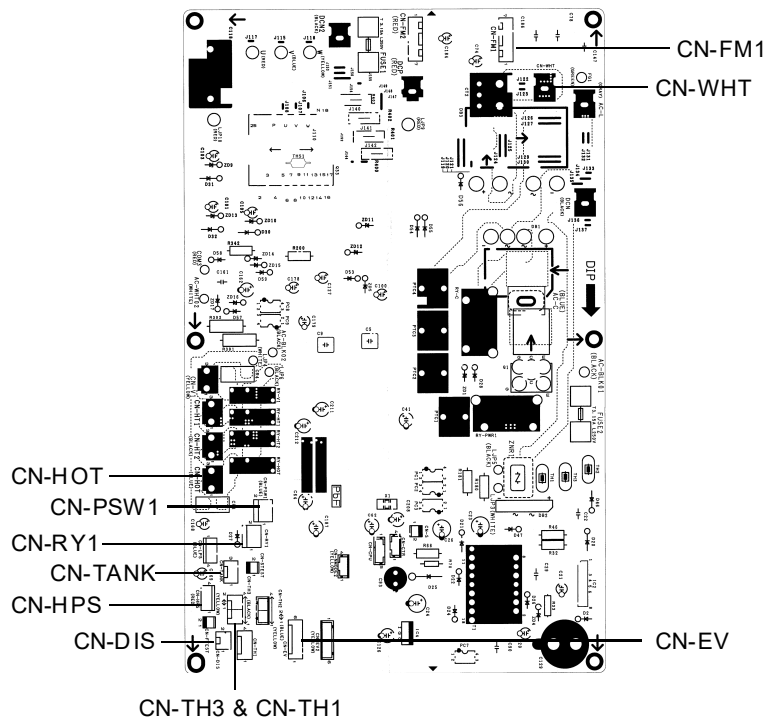

## 20.9 To Remove Pressure Relief Valve and Air Purge Valve

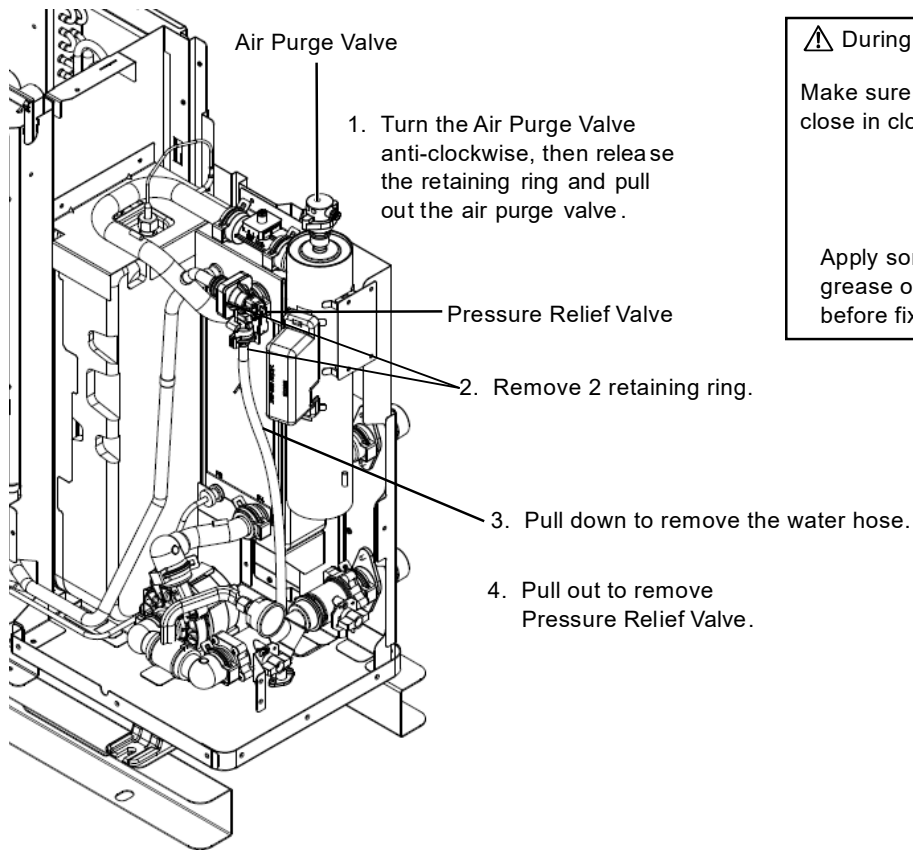

⚠ During reinstall Air Purge Valve.

Make sure plug is fully close in clockwise direction.

Packing

Apply some water based grease on packing surface before fix with shut off valve.

## 20.10 To Remove Flow Sensor

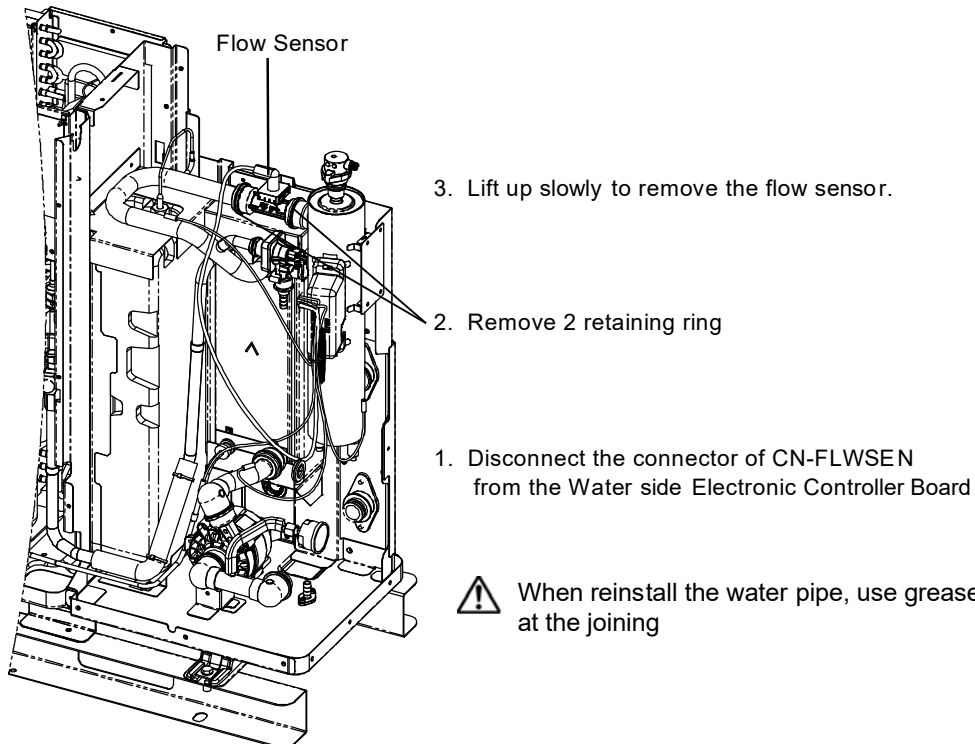

## 20.11 To Remove Water Pump

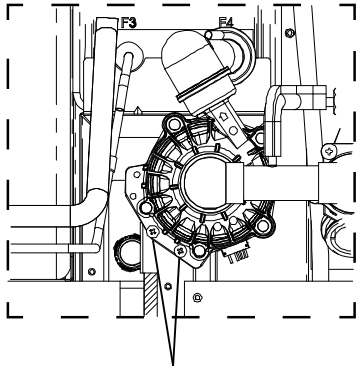

2. Remove 2 screw from Pump Bracket.

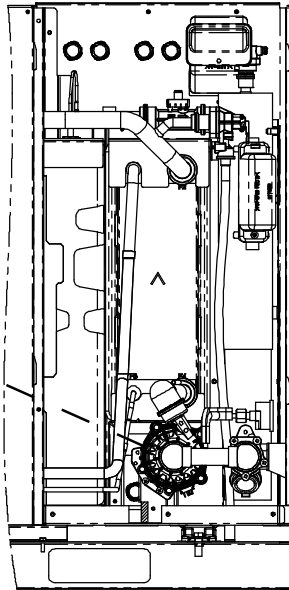

1. Disconnect CN-PUMP1 connector from Electronic Controller Board.

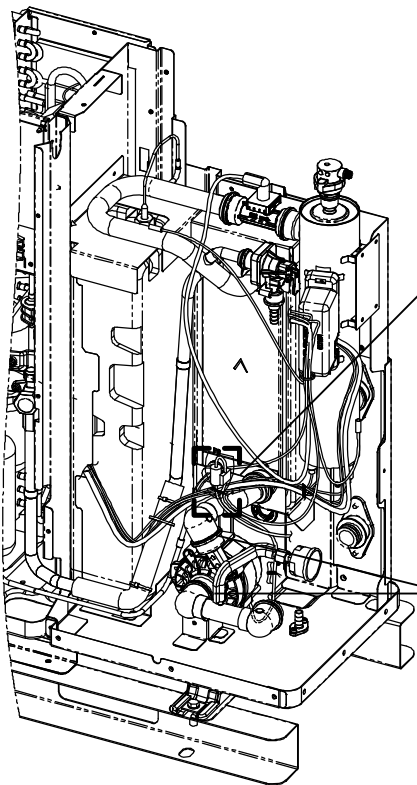

3. Remove 2 retaining ring, then slowly pull out the water pump.



If pump is replace, please follow below instruction.

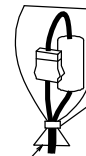

Hose Band

Make sure bag opening facing down (To prevent water accumulate)

1. Please fix bag around the connector as shown, and seal it with a band.



When reinstall the water pipe, use grease or water at the joining.

## 20.12 To Remove Heater

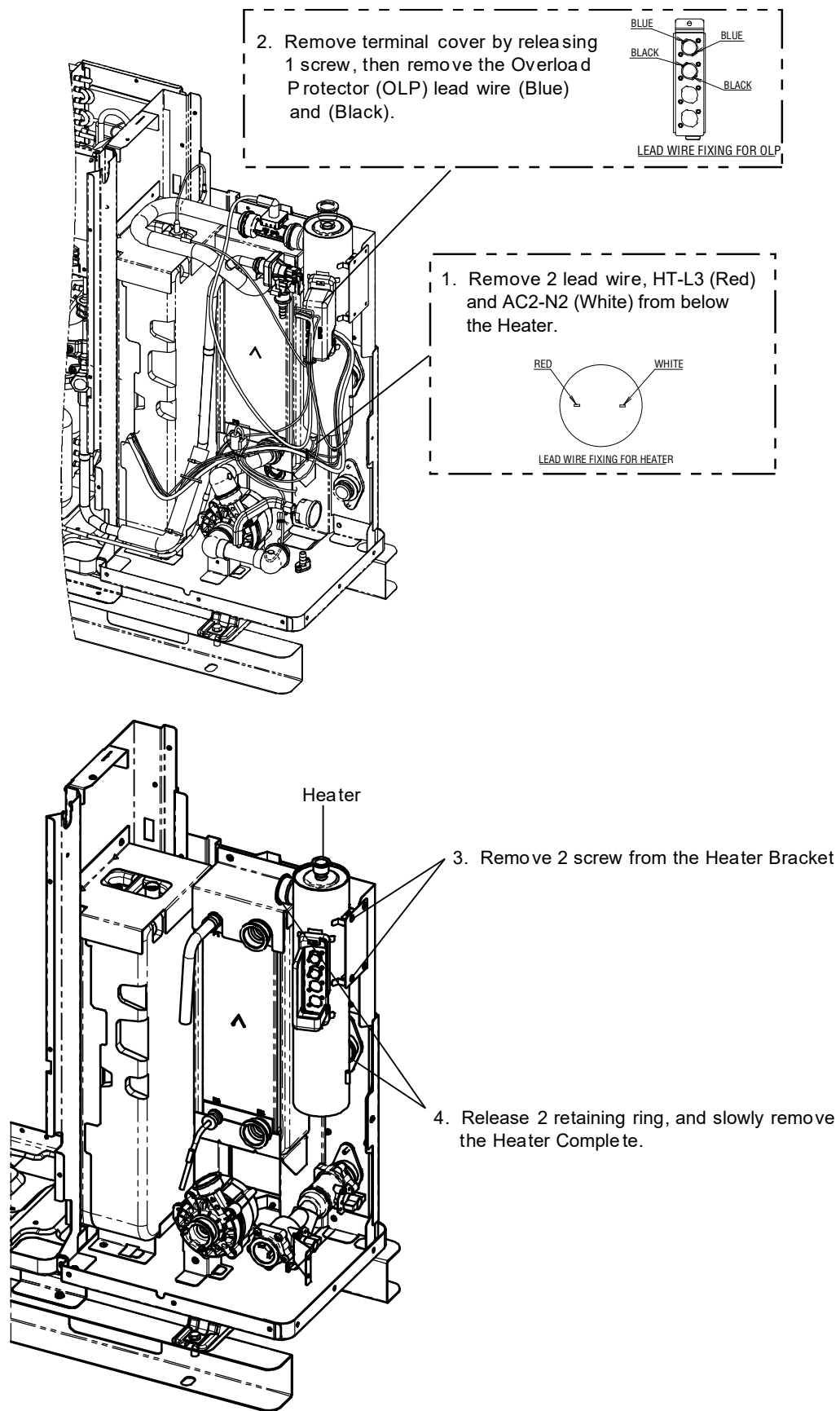

## 20.13 To Remove Filter

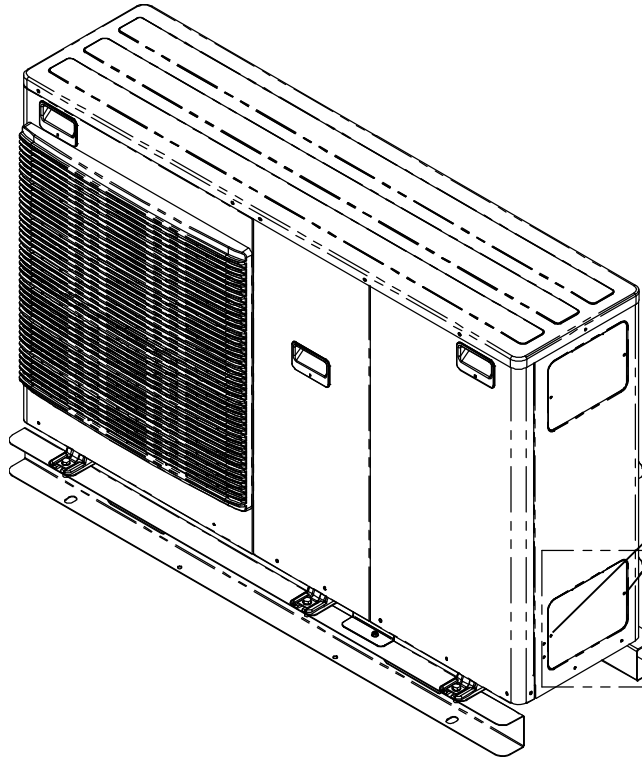

1. Remove the access cover by removing 2 screws.

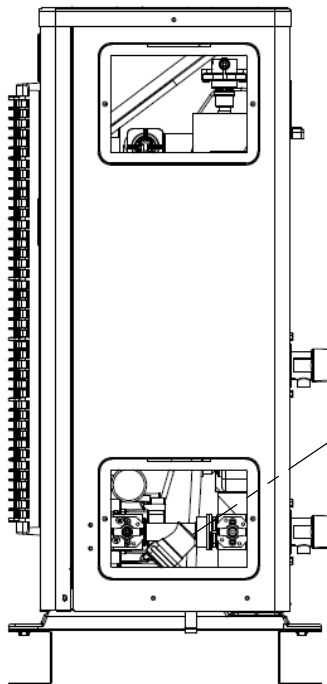

1. Set 2 valve for the Water Filter Set to "CLOSE".

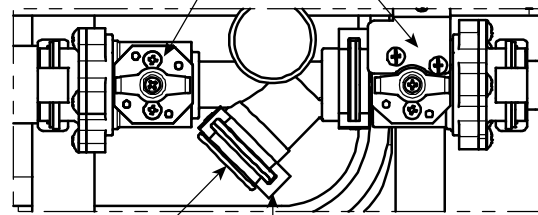

Water Filter

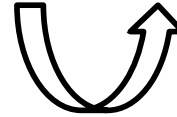

2. Pull up the Water Filter set.

3. Remove the retaining ring, then remove the the Water Filter.

# 21. Technical Data

## 21.1 Operation Characteristics

### 21.1.1 WH-MDC05J3E5

#### Heating Characteristics at Different Outdoor Air Temperature

Condition

Outdoor air temperature : 7°C (DBT), 6°C (WBT)

Indoor water inlet temperature : 30°C

Indoor water outlet temperature : 35°C

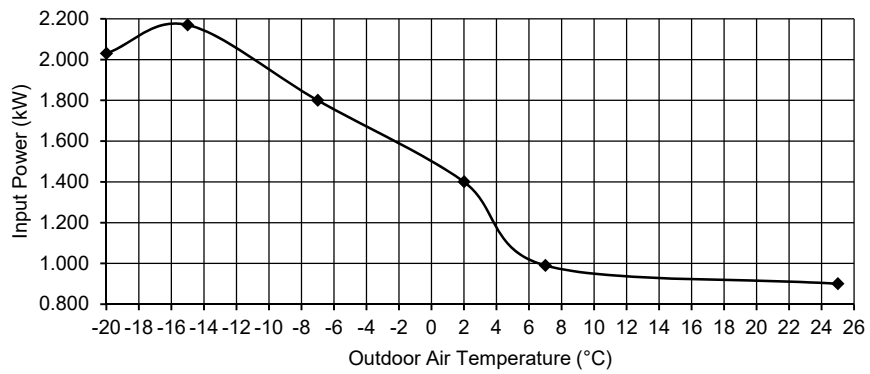
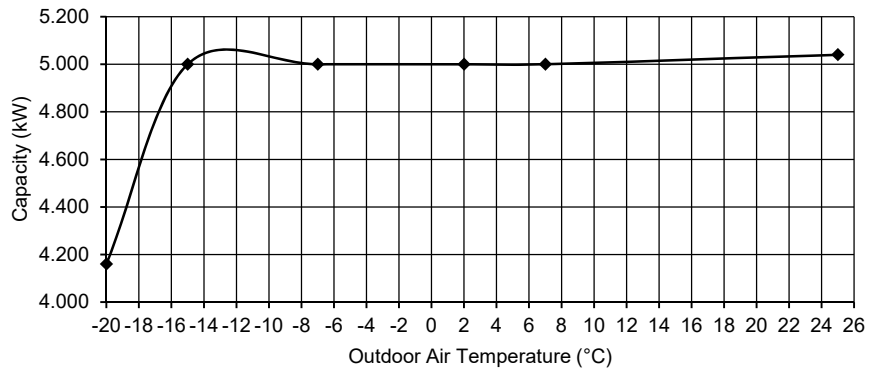

## Cooling Characteristics at Different Outdoor Air Temperature

Condition

Outdoor air temperature : 35°C (DBT), -°C (WBT)

Indoor water inlet temperature : 12°C

Indoor water outlet temperature : 7°C

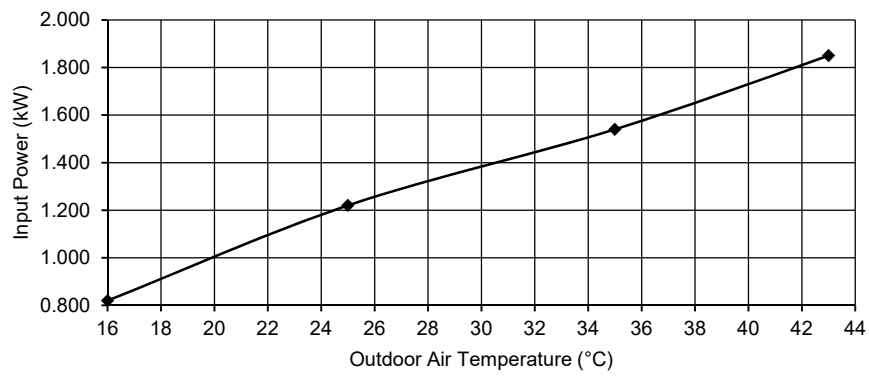
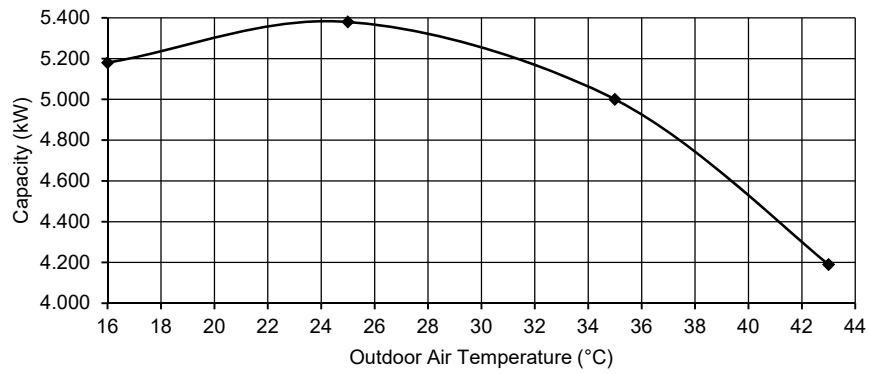



## Cooling Characteristics at Different Outdoor Air Temperature

Condition

Outdoor air temperature : 35°C (DBT), -°C (WBT)

Indoor water inlet temperature : 19°C

Indoor water outlet temperature : 14°C

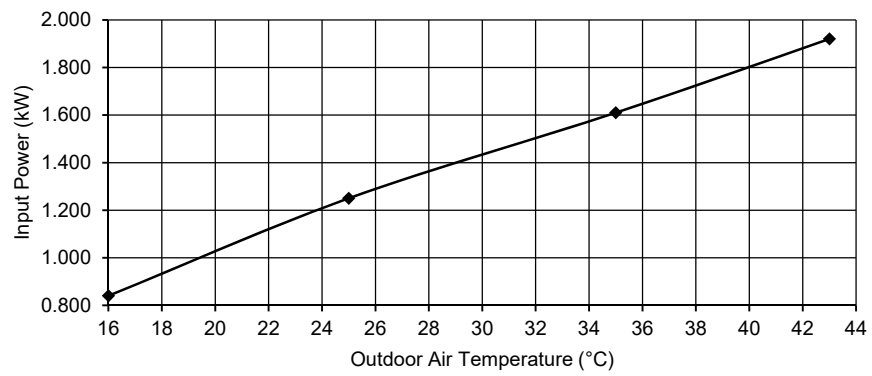
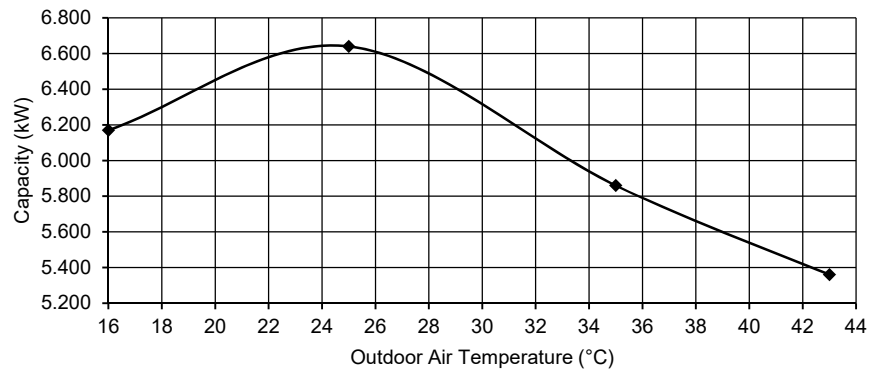

## Cooling Characteristics at Different Outdoor Air Temperature

Condition

Outdoor air temperature : 35°C (DBT), -°C (WBT)

Indoor water inlet temperature : 23°C

Indoor water outlet temperature : 18°C

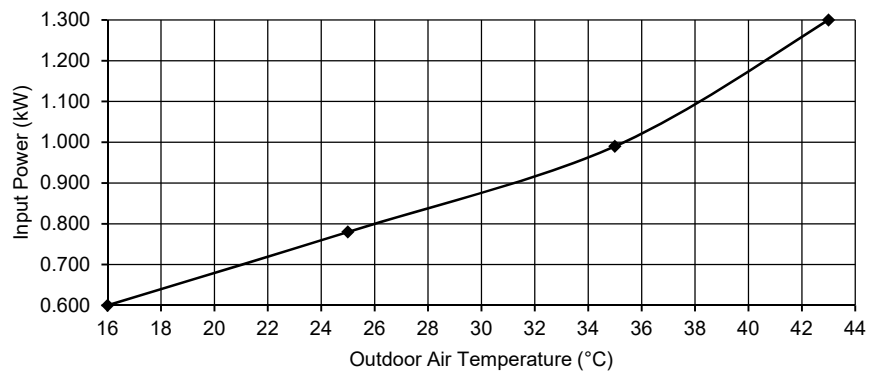
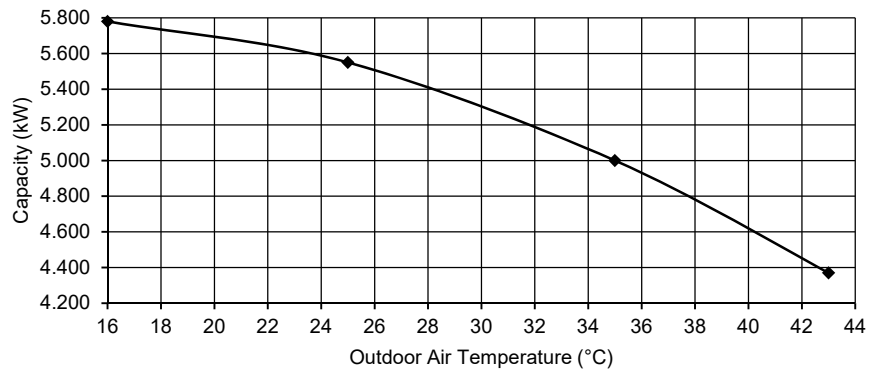

### 21.1.2 WH-MDC07J3E5

#### Heating Characteristics at Different Outdoor Air Temperature

Condition

Outdoor air temperature : 7°C (DBT), 6°C (WBT)

Indoor water inlet temperature : 30°C

Indoor water outlet temperature : 35°C

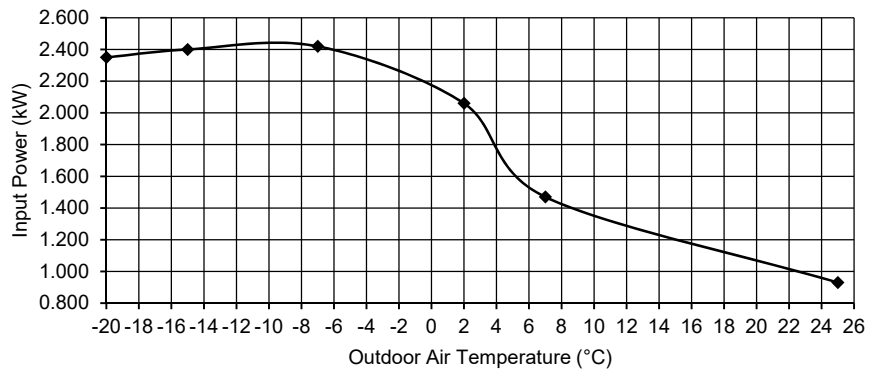
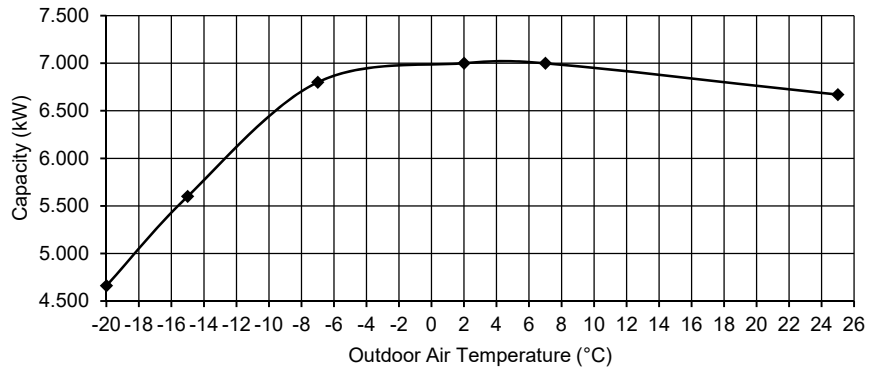

## Cooling Characteristics at Different Outdoor Air Temperature

Condition

Outdoor air temperature : 35°C (DBT), -°C (WBT)

Indoor water inlet temperature : 12°C

Indoor water outlet temperature : 7°C

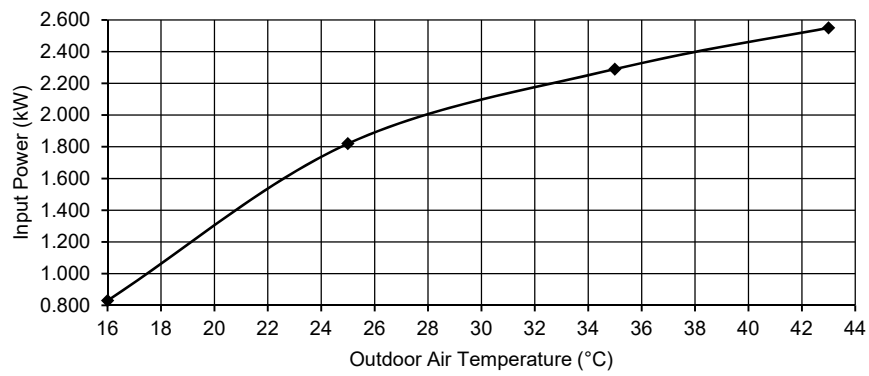
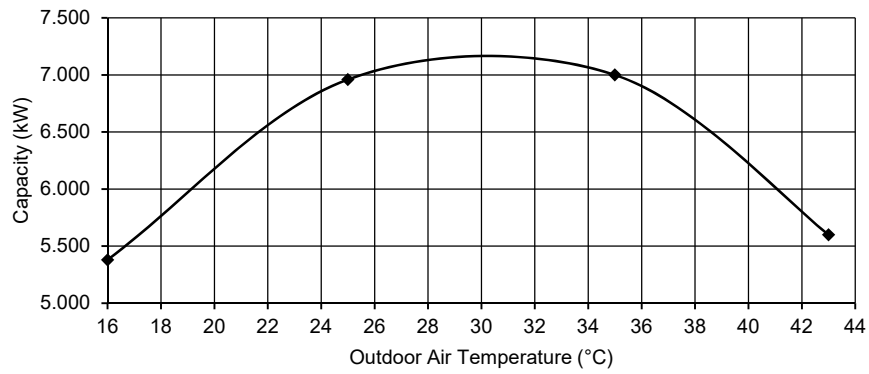

## Cooling Characteristics at Different Outdoor Air Temperature

Condition

Outdoor air temperature : 35°C (DBT), -°C (WBT)

Indoor water inlet temperature : 19°C

Indoor water outlet temperature : 14°C

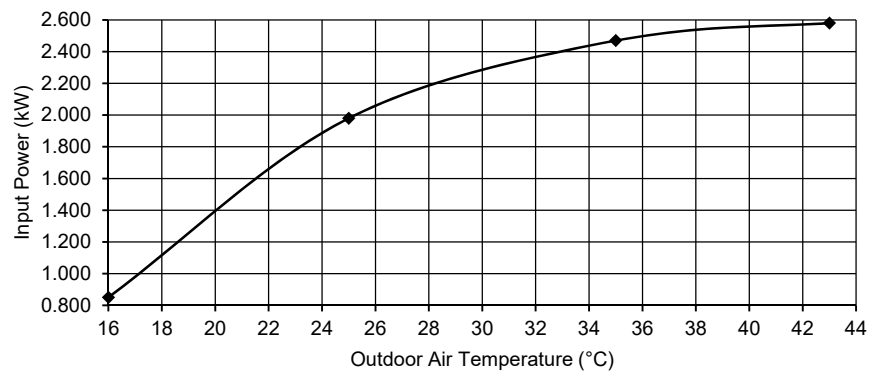
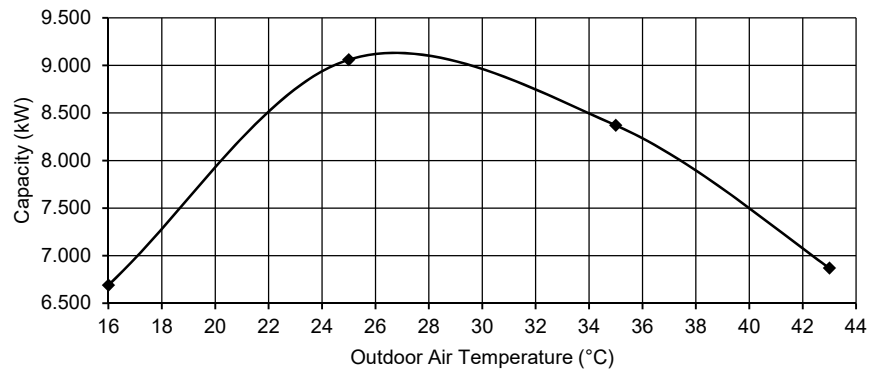

## Cooling Characteristics at Different Outdoor Air Temperature

Condition

Outdoor air temperature : 35°C (DBT), -°C (WBT)

Indoor water inlet temperature : 23°C

Indoor water outlet temperature : 18°C

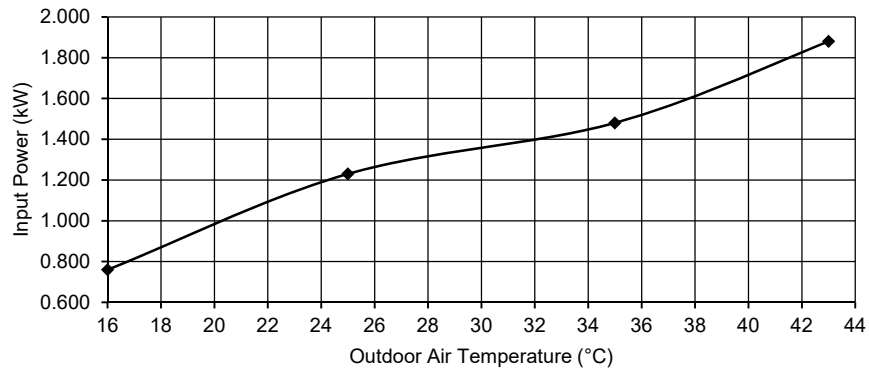
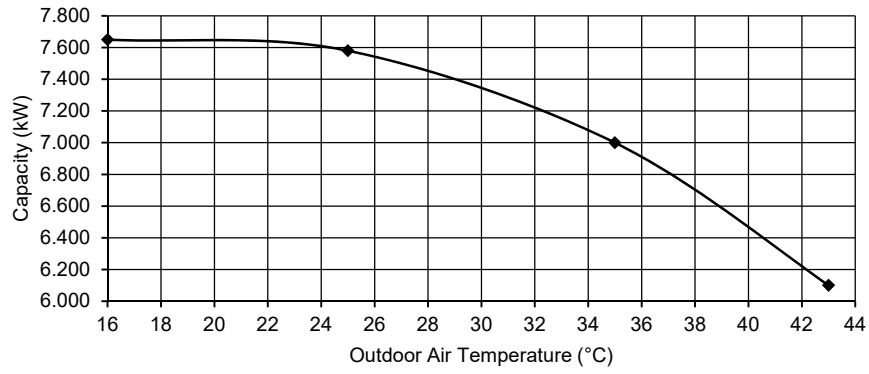

### 21.1.3 WH-MDC09J3E5

#### Heating Characteristics at Different Outdoor Air Temperature

Condition

Outdoor air temperature : 7°C (DBT), 6°C (WBT)

Indoor water inlet temperature : 30°C

Indoor water outlet temperature : 35°C

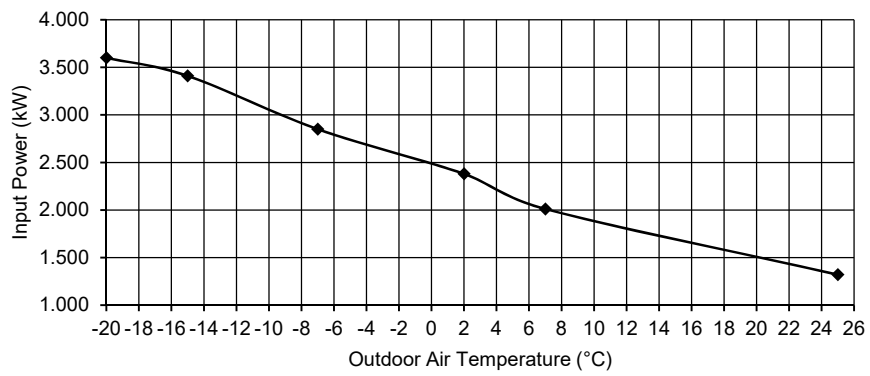
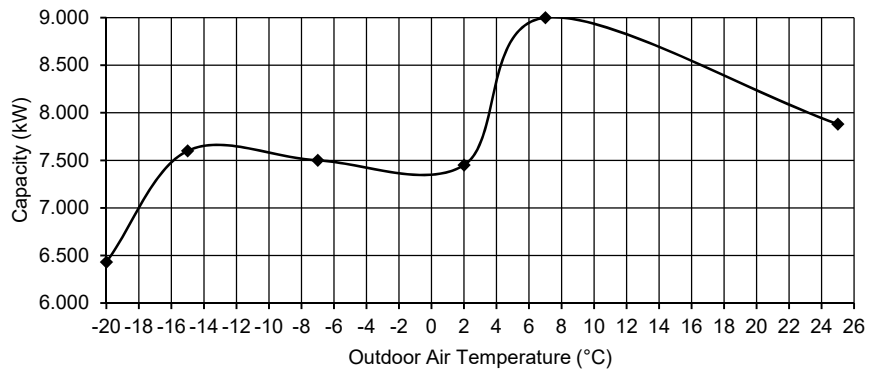

## Cooling Characteristics at Different Outdoor Air Temperature

Condition

Outdoor air temperature : 35°C (DBT), -°C (WBT)

Indoor water inlet temperature : 12°C

Indoor water outlet temperature : 7°C

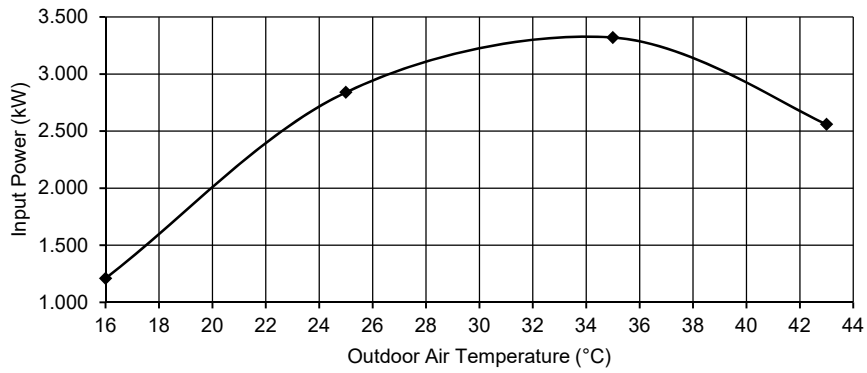
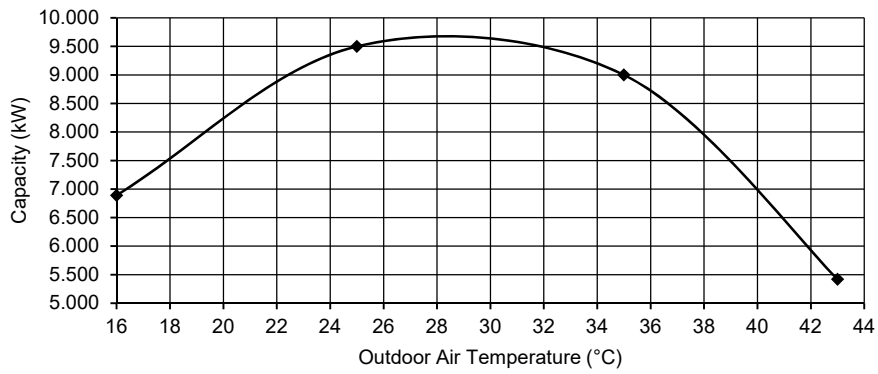



## Cooling Characteristics at Different Outdoor Air Temperature

Condition

Outdoor air temperature : 35°C (DBT), -°C (WBT)

Indoor water inlet temperature : 19°C

Indoor water outlet temperature : 14°C

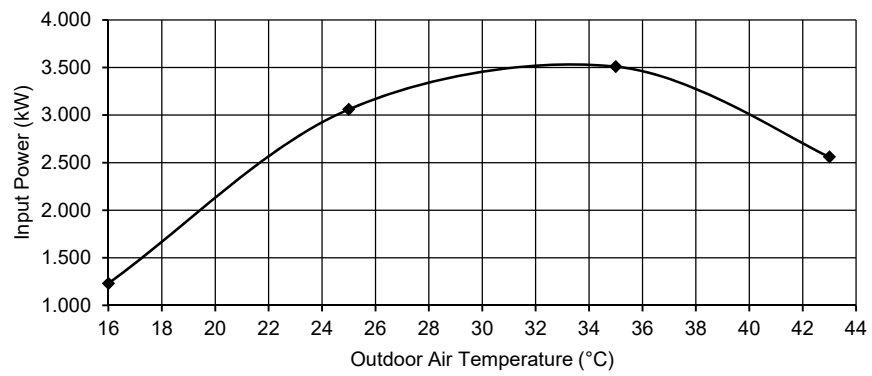
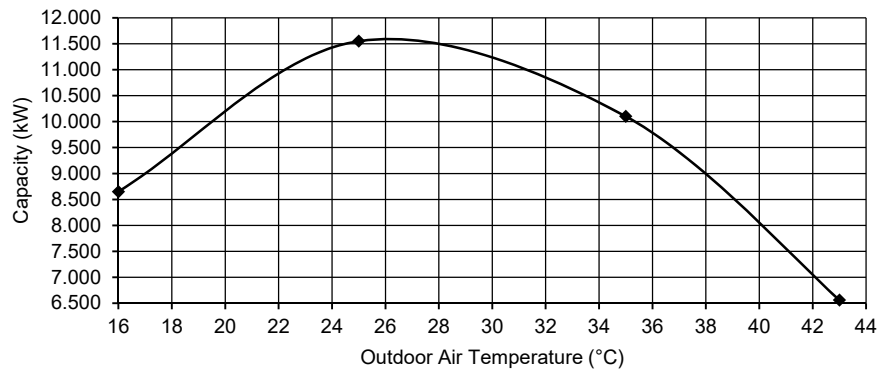

## Cooling Characteristics at Different Outdoor Air Temperature

Condition

Outdoor air temperature : 35°C (DBT), -°C (WBT)

Indoor water inlet temperature : 23°C

Indoor water outlet temperature : 18°C

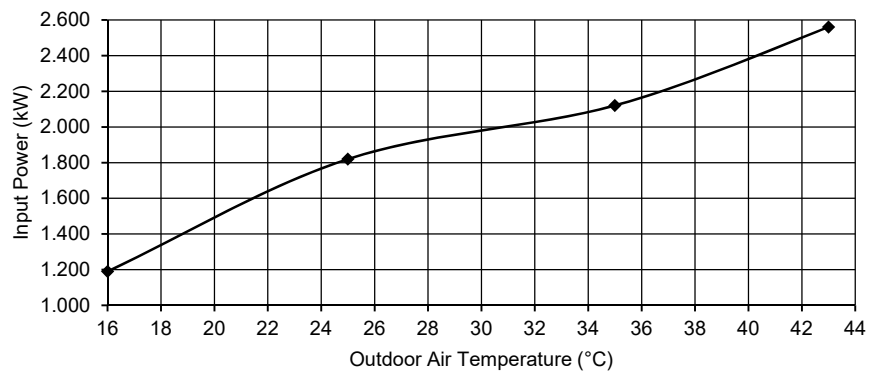
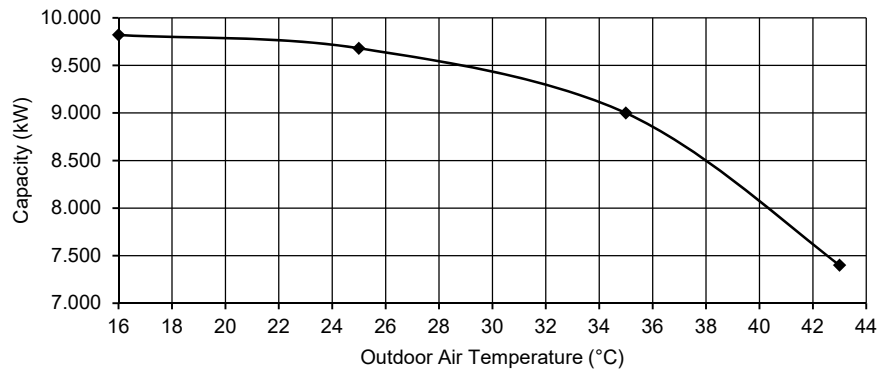

## 21.2 Heating Capacity Table

### 21.2.1 WH-MDC05J3E5

Water Out	25°C		35°C		45°C		55°C		60°C	
Outdoor Air (°C)	Capacity (W)	Input Power (W)	Capacity (W)	Input Power (W)	Capacity (W)	Input Power (W)	Capacity (W)	Input Power (W)	Capacity (W)	Input Power (W)
-20	4370	1730	4160	2030	3840	2370	3430	2640		
-15	5130	1780	5000	2170	4750	2510	3700	2450		
-7	5170	1490	5000	1800	4800	2160	5000	2700	4680	2710
2	5000	1110	5000	1400	5000	1810	5000	2200	4800	2400
7	5090	780	5000	990	5000	1310	5000	1660	4580	1900
25	4960	770	5040	900	5310	1160	5610	1340	5150	1330

### 21.2.2 WH-MDC07J3E5

Water Out	25°C		35°C		45°C		55°C		60°C	
Outdoor Air (°C)	Capacity (W)	Input Power (W)	Capacity (W)	Input Power (W)	Capacity (W)	Input Power (W)	Capacity (W)	Input Power (W)	Capacity (W)	Input Power (W)
-20	4860	2030	4660	2350	4440	2750	4230	3130		
-15	5800	2110	5600	2400	5300	2840	5000	3320		
-7	6760	2070	6800	2420	6300	2820	6300	3390	4740	2760
2	6830	1660	7000	2060	6850	2500	6300	2920	4800	2400
7	7320	1190	7000	1470	7000	1960	7000	2480	6180	2440
25	6800	640	6670	930	6790	1380	6700	1800	6220	1780

### 21.2.3 WH-MDC09J3E5

Water Out	25°C		35°C		45°C		55°C		60°C	
Outdoor Air (°C)	Capacity (W)	Input Power (W)	Capacity (W)	Input Power (W)	Capacity (W)	Input Power (W)	Capacity (W)	Input Power (W)	Capacity (W)	Input Power (W)
-20	5330	2360	6430	3600	5780	3830	4830	3640		
-15	7760	3200	7600	3410	7000	3710	5600	3800		
-7	7390	2450	7500	2850	7300	3370	7000	3890	6440	3670
2	7380	1890	7450	2380	7000	2850	7000	3300	5460	2720
7	9150	1590	9000	2010	9000	2610	8950	3220	7250	2870
25	8020	980	7880	1320	8460	1860	7600	2030	6300	1870

## 21.3 Cooling Capacity Table

### 21.3.1 WH-MDC05J3E5

OD	Water Out 7°C		Water Out 14°C		Water Out 18°C	
	IQ	IP	IQ	IP	IQ	IP
16	5180	820	6170	840	5780	600
25	5380	1220	6640	1250	5550	780
35	5000	1540	5860	1610	5000	990
43	4190	1850	5360	1920	4370	1300

### 21.3.2 WH-MDC07J3E5

OD	Water Out 7°C		Water Out 14°C		Water Out 18°C	
	IQ	IP	IQ	IP	IQ	IP
16	5380	830	6690	850	7650	760
25	6960	1820	9060	1980	7580	1230
35	7000	2290	8370	2470	7000	1480
43	5600	2550	6870	2580	6100	1880

### 21.3.3 WH-MDC09J3E5

OD	Water Out 7°C		Water Out 14°C		Water Out 18°C	
	IQ	IP	IQ	IP	IQ	IP
16	6890	1210	8650	1230	9820	1190
25	9500	2840	11550	3060	9680	1820
35	9000	3320	10100	3510	9000	2120
43	5420	2560	6560	2560	7400	2560

IQ = Capacity (W)  
IP = Input Power (W)

## 22. Exploded View and Replacement Parts List

### 22.1 Water System

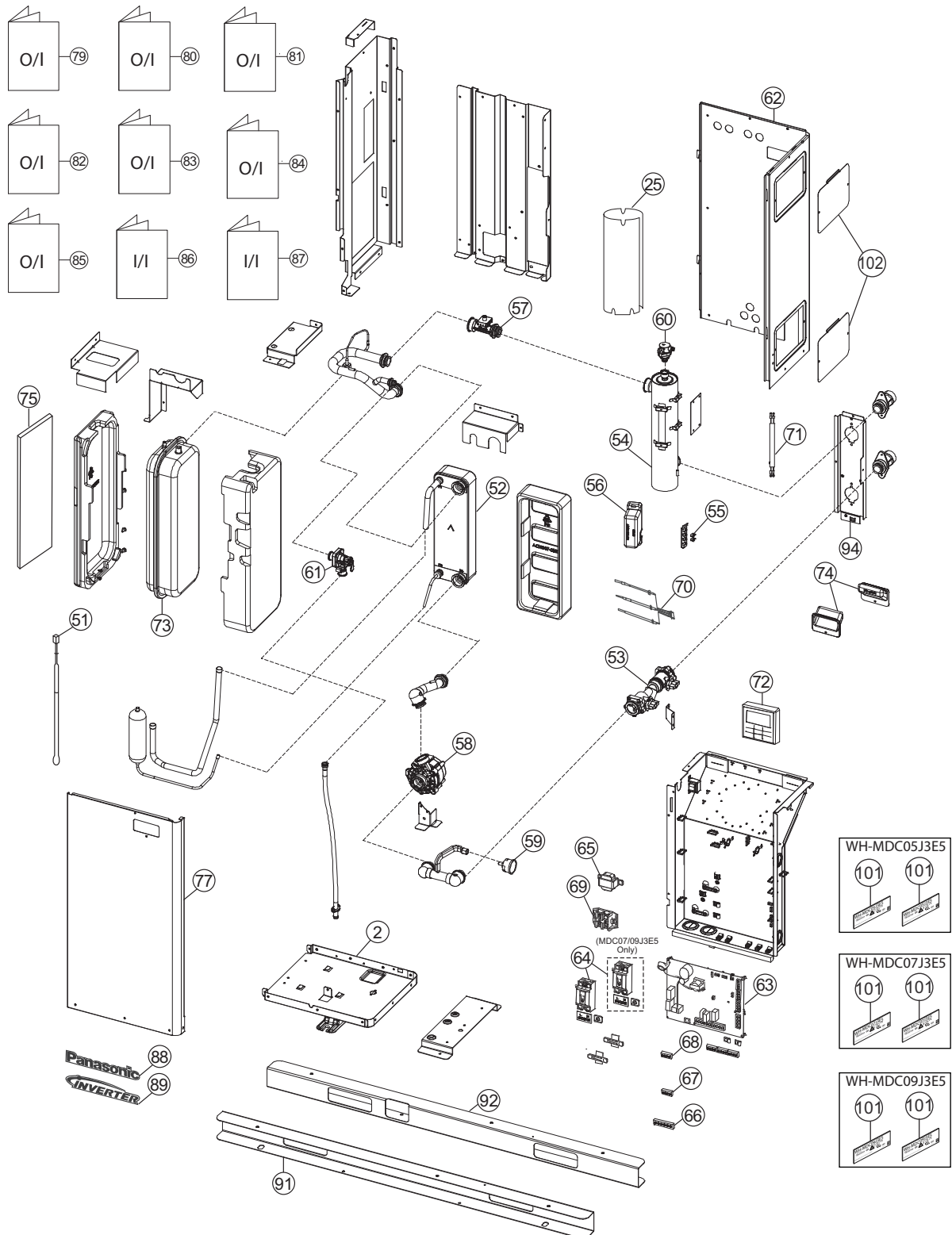

**Note:**

The above exploded view is for the purpose of parts disassembly and replacement.  
The non-numbered parts are not kept as standard service parts.

## 22.2 Refrigerant System

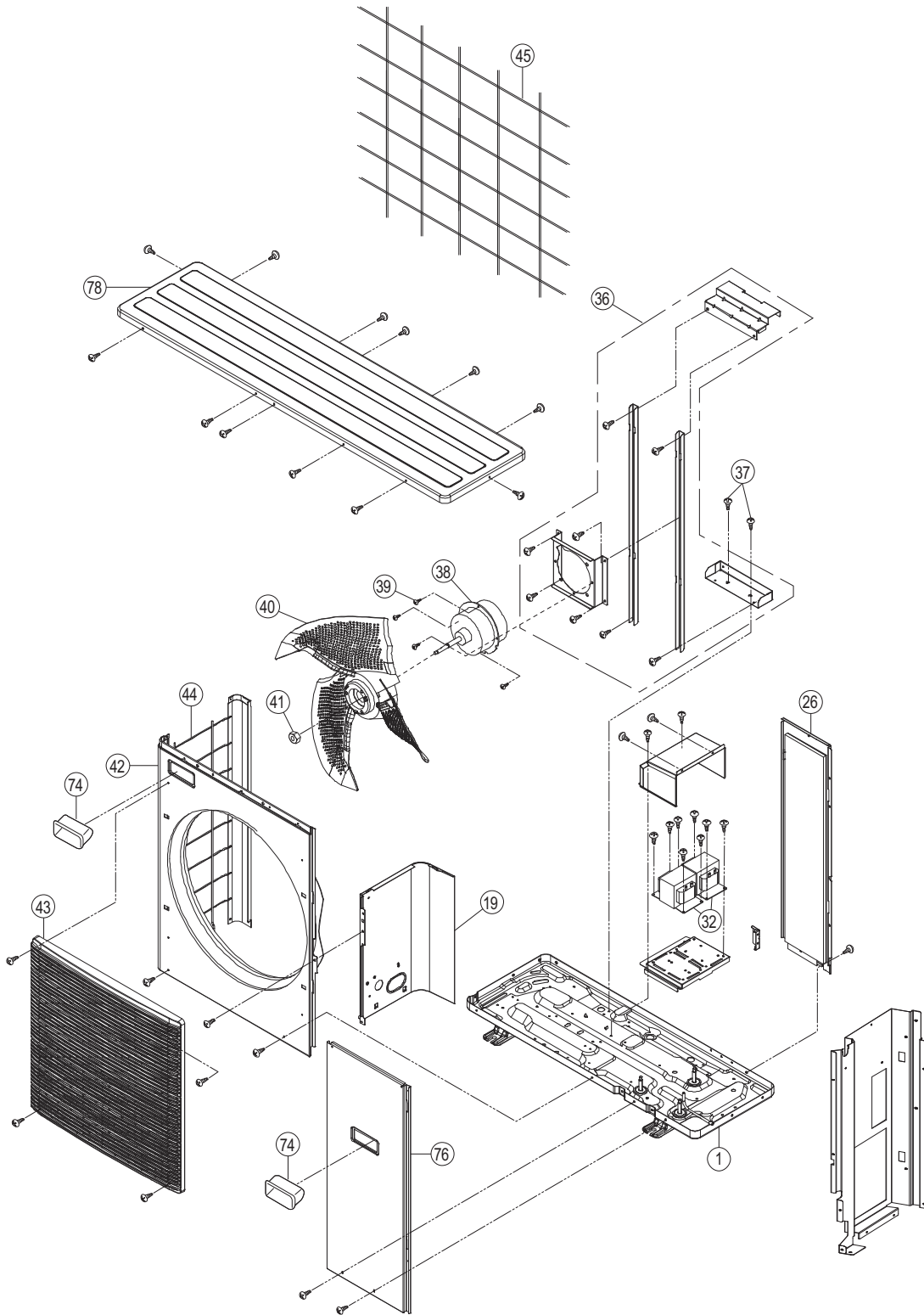

Note:  
The above exploded view is for the purpose of parts disassembly and replacement.  
The non-numbered parts are not kept as standard service parts.

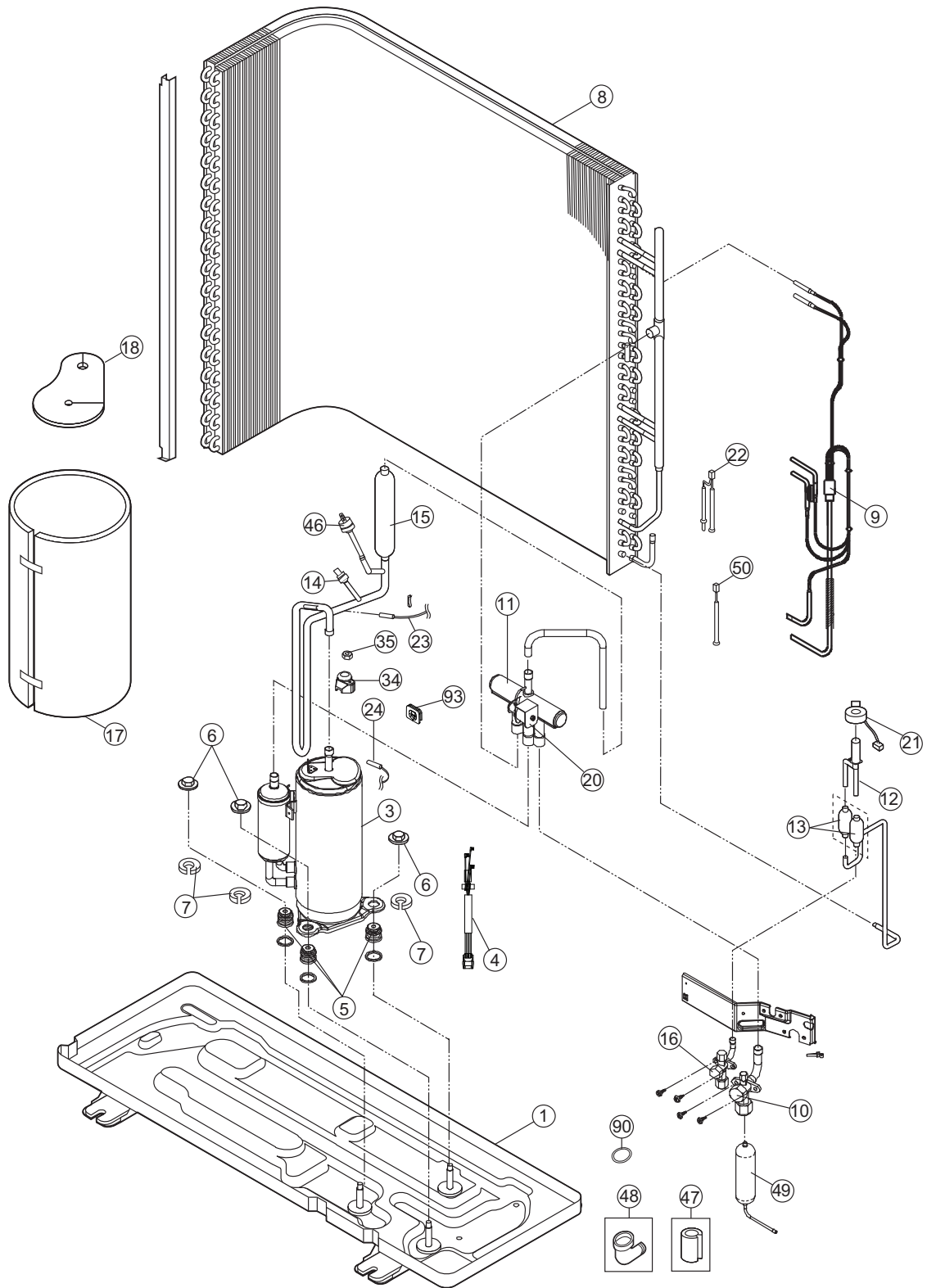

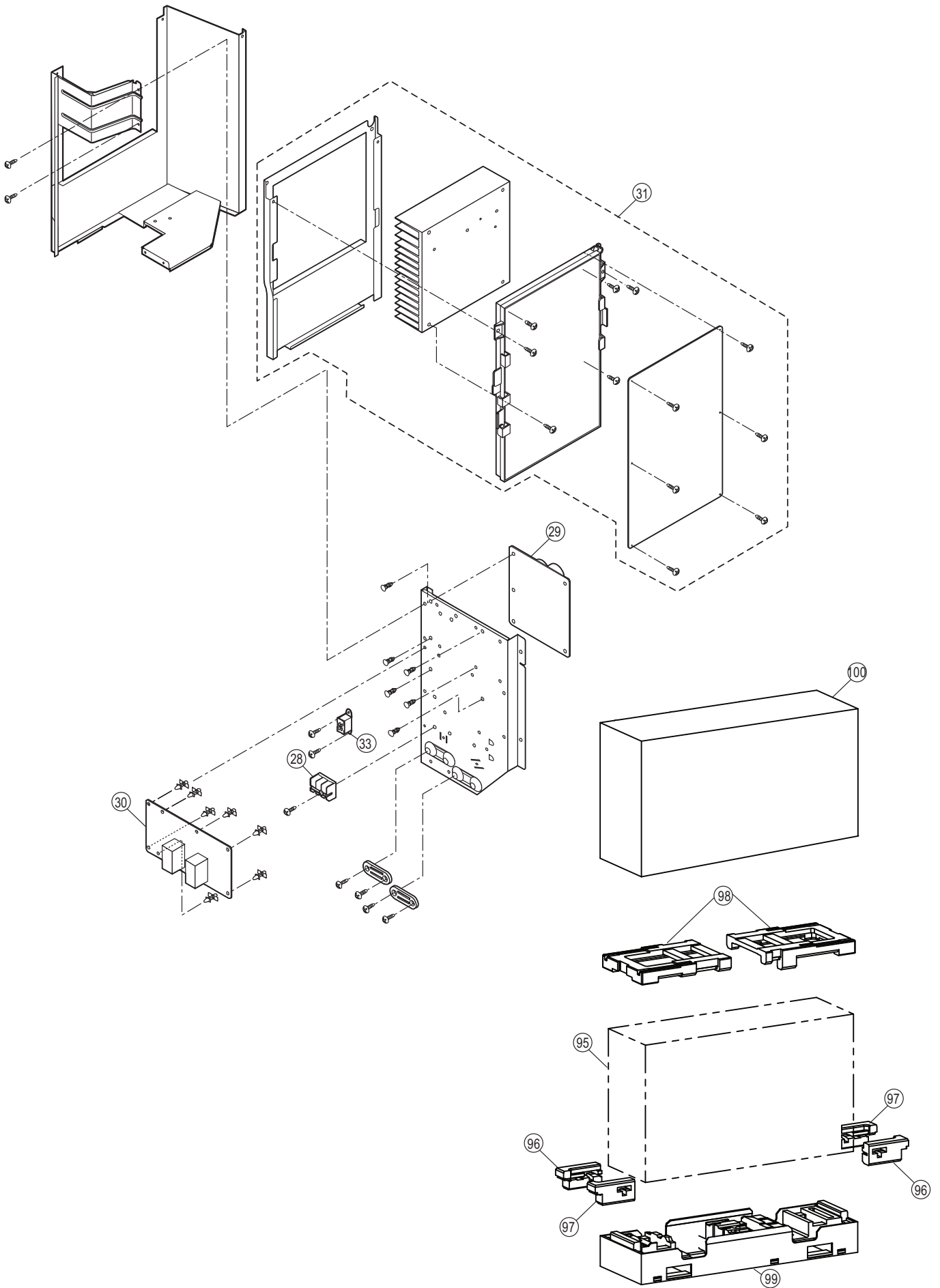

Note:  
 The above exploded view is for the purpose of parts disassembly and replacement.  
 The non-numbered parts are not kept as standard service parts.



Note:  
 The above exploded view is for the purpose of parts disassembly and replacement.  
 The non-numbered parts are not kept as standard service parts.



<Model: WH-MDC05J3E5>

SAFETY	REF. NO.	DESCRIPTION & NAME	QTY.	WH-MDC05J3E5	REMARK
	1	BASE PAN ASS'Y (1)	1	CWD52K1282	
	2	BASE PAN ASS'Y (2)	1	ACXD52K03580	
	3	COMPRESSOR	1	9KD240XBD21	O
	4	LEADWIRE COMPRESSOR	1	CWA68C1810	O
	5	BUSHING - COMPRESSOR MOUNT	3	CWH50055	
	6	NUT-COMPRESSOR MOUNT	3	CWH561049	
	7	GASKET FOR TERMINAL COVER	3	CWB811017	
	8	CONDENSER CO.	1	ACXB32C09150	
	9	TUBE ASSY (CAP.TUBE)	1	CWT07K1547	
	10	3-WAYS VALVE (GAS)	1	CWB011700	
	11	4-WAYS VALVE	1	CWB001026J	
	12	EXPANSION VALVE	1	CWB051029	
	13	STRAINER	2	CWB111024	
	14	HIGH PRESSURE SENSOR CN-HPS	1	CWA501463	
	15	DISCHARGE MUFFLER	1	CWB121013	
	16	3-WAYS VALVE(LIQUID)	1	CWB011698	
	17	SOUND PROOF MATERIAL - COMP. BODY	1	ACXG30-10121	
	18	SOUND PROOF MATERIAL - COMP. TOP	1	CWG302246	
	19	SOUND PROOF BOARD	1	CWH151429	
	20	V-COIL COMPLETE(4 WAY VALVE)	1	CWA43C2169J	O
	21	V-COIL COMPLETE(MAIN EXPANSION VALVE)	1	CWA43C2342	O
	22	SENSOR-COMP.(OUTDOOR AIR,PIPE TEMP)	1	CWA50C2652	O
	23	SENSOR-COMP.(DISCHARGE TEMP)	1	CWA50C2528	O
	24	SENSOR-COMP.(DEFROST TEMP)	1	CWA50C2665	O
	25	SOUND PROOF MATERIAL	1	ACXG30-10190	
	26	CABINET REAR PLATE-COMPLETE	1	ACXE02C01210	
	28	TERMINAL BOARD ASS'Y(1,2,3,4,5)	1	CWA28K1251	O
	29	ELECTRONIC CO.(CAPACITOR)	1	CWA746184	O
	30	ELECTRONIC CO.(NOISE FILTER)	1	ACXA73-34930	O
	31	ELECTRONIC CONTROLLER (MAIN) - REFRIGERANT	1	ACXA73C58260R	O
	32	REACTOR	1	G0C193J00021	O
	33	ELECTRO MAGNETIC SWITCH	-	-	O
	34	TERMINAL COVER	1	CWH171039A	
	35	NUT - TERMINAL COVER	1	CWH7080300J	
	36	FAN MOTOR BRACKET	1	ACXD54K02150	
	37	SCREW-FAN MOTOR BRACKET	4	CWH551040J	
	38	FAN MOTOR	1	EHDS80C60AC	O
	39	SCREW-FAN MOTOR MOUNT	4	CWH551323	
	40	PROPELLER FAN ASSY	1	CWH00K1006	
	41	NUT	1	CWH561092	
	42	CABINET FRONT PLATE	1	ACXE06-03400A	
	43	DISCHARGE GRILLE	1	CWE201154	
	44	CABINET SIDE PLATE ASSY	1	CWE04K1019A	
	45	WIRE NET	1	CWD041059	
	46	HIGH PRESSURE SWITCH	1	CWA101013	











SAFETY	REF. NO.	DESCRIPTION & NAME	QTY.	WH-MDC05J3E5	REMARK
	47	ACCESSORY CO.(RUBBER CAP)	1	CWH82C1839	
	48	ACCESSORY CO.(DRAIN ELBOW)	1	CWG87C900	
	49	RECEIVER	1	ACXB14-00670	
⚠	50	SENSOR-COMPLETE	1	CWA50C3379	O
⚠	51	BASE PAN HEATER	1	CWA341071	O
	52	HOT WATER COIL-COMPLETE	1	ACXB90C00960	
	53	FILTER COMPLETE	1	ACXB51C00100	
⚠	54	HEATER ASS'Y	1	ACXA34K00240	O
⚠	55	THERMOSTAT	2	CWA151074	O
	56	TERMINAL COVER	1	CWH171051	
	57	FLOW SENSOR	1	ACXB62-00911	
⚠	58	PUMP	1	ACXB53-00390	O
	59	PRESSURE GAUGE	1	CWB070003	
	60	AIR PURGE VALVE	1	ACXB62-00130	
	61	PRESSURE RELIEF VALVE	1	ACXB62-00740	
	62	CABINET SIDE PLATE	1	ACXE04-11720A	
⚠	63	ELECTRONIC CONTROLLER (MAIN) - WATER	1	ACXA73C58300R	O
	64	CIRCUIT BREAKER	1	CWA181005	O
⚠	65	REACTOR	1	G0C103Z00003	O
⚠	66	TERMINAL BOARD ASS'Y(1,2,3,4,5,6)	1	CWA28K1341	O
⚠	67	TERMINAL BOARD ASS'Y(7,8,9,10,11,12)	2	CWA28K1340	O
⚠	68	TERMINAL BOARD ASS'Y(13,14,15,16,17,18)	3	CWA28K1343	O
⚠	69	TERMINAL BOARD ASS'Y(A,B)	1	CWA28K1238	O
⚠	70	SENSOR-COMPLETE(WATER IN,OUT, REF TEMP)	1	ACXA50C06750	O
⚠	71	SENSOR-COMPLETE(HEX WATER OUTLET)	1	ACXA50C06660	O
⚠	72	REMOTE CONTROL COMPLETE	1	ACXA75C15750	O
	73	RECEIVER	1	CWB141066	
	74	HANDLE	4	CWE161021	
	75	SOUND PROOF MATERIAL	1	ACXG30-10210	
	76	CABINET FRONT PLATE CO.	1	ACXE06C03790	
	77	CABINET FRONT PLATE	1	ACXE06-04500A	
	78	CABINET TOP PLATE CO.	1	ACXE03C01980	
	79	OPERATING INSTRUCTION	1	ACXF55-26660	
	80	OPERATING INSTRUCTION	1	ACXF55-26670	
	81	OPERATING INSTRUCTION	1	ACXF55-26680	
	82	OPERATING INSTRUCTION	1	ACXF55-26690	
	83	OPERATING INSTRUCTION	1	ACXF55-26700	
	84	OPERATING INSTRUCTION	1	ACXF55-26710	
	85	OPERATING INSTRUCTION	1	ACXF55-27620	
	86	INSTALLATION INSTRUCTION	1	ACXF60-38370	
	87	INSTALLATION INSTRUCTION	1	ACXF60-38380	
	88	PANASONIC BADGE	1	CWE373439	
	89	INVERTER BADGE	1	CWE373441	
	90	PACKING-L.TUBE	1	CWB81012	
	91	CONNECTING BAR	1	CWE261213A	
	92	CONNECTING BAR	1	CWE261214A	
	93	GASKET FOR TERMINAL COVER	1	CWB811177	

SAFETY	REF. NO.	DESCRIPTION & NAME	QTY.	WH-MDC05J3E5	REMARK
	94	HOLDER COUPLING	1	ACXH35-01880A	
	95	BAG	1	CWG861483	
	96	SHOCK ABSORBER	2	CWG713660	
	97	SHOCK ABSORBER	2	CWG713661	
	98	SHOCK ABSORBER	2	CWG713662	
	99	BASE BOARD-COMPLETE	1	ACXG62C02080	
	100	C.C.CASE	1	ACXG50-55100	
	101	MODEL LABEL	2	ACXF85-31560	
	102	FLAT PLATE	2	ACXD64-00400A	

**Note:**

- All parts are supplied from PAPAMY, Malaysia (Vendor Code: 00029488).
- "O" marked parts are recommended to be kept in stock.

<Model: WH-MDC07J3E5 WH-MDC09J3E5>

SAFETY	REF. NO.	DESCRIPTION & NAME	QTY.	WH-MDC07J3E5	WH-MDC09J3E5	REMARK
	1	BASE PAN ASS'Y (1)	1	CWD52K1282	←	
	2	BASE PAN ASS'Y (2)	1	ACXD52K03580	←	
	3	COMPRESSOR	1	9KD240XBD21	←	O
	4	LEADWIRE COMPRESSOR	1	CWA68C1810	←	O
	5	BUSHING - COMPRESSOR MOUNT	3	CWH50055	←	
	6	NUT-COMPRESSOR MOUNT	3	CWH561049	←	
	7	GASKET FOR TERMINAL COVER	3	CWB811017	←	
	8	CONDENSER CO.	1	ACXB32C09150	←	
	9	TUBE ASSY (CAP.TUBE)	1	CWT07K1547	←	
	10	3-WAYS VALVE (GAS)	1	CWB011700	←	
	11	4-WAYS VALVE	1	CWB001026J	←	
	12	EXPANSION VALVE	1	CWB051029	←	
	13	STRAINER	2	CWB111024	←	
	14	HIGH PRESSURE SENSOR CN-HPS	1	CWA501463	←	
	15	DISCHARGE MUFFLER	1	CWB121013	←	
	16	3-WAYS VALVE(LIQUID)	1	CWB011698	←	
	17	SOUND PROOF MATERIAL - COMP. BODY	1	ACXG30-10121	←	
	18	SOUND PROOF MATERIAL - COMP. TOP	1	CWG302246	←	
	19	SOUND PROOF BOARD	1	CWH151429	←	
	20	V-COIL COMPLETE(4 WAY VALVE)	1	CWA43C2169J	←	O
	21	V-COIL COMPLETE(MAIN EXPANSION VALVE)	1	CWA43C2342	←	O
	22	SENSOR-COMP.(OUTDOOR AIR,PIPE TEMP)	1	CWA50C2652	←	O
	23	SENSOR-COMP.(DISCHARGE TEMP)	1	CWA50C2528	←	O
	24	SENSOR-COMP.(DEFROST TEMP)	1	CWA50C2665	←	O
	25	SOUND PROOF MATERIAL	1	ACXG30-10190	←	
	26	CABINET REAR PLATE-COMPLETE	1	ACXE02C01210	←	
	28	TERMINAL BOARD ASS'Y(1,2,3,4,5)	1	CWA28K1251	←	O
	29	ELECTRONIC CO.(CAPACITOR)	1	CWA746184	←	O
	30	ELECTRONIC CO.(NOISE FILTER)	1	ACXA73-34920	←	O
	31	ELECTRONIC CONTROLLER (MAIN) - REFRIGERANT	1	ACXA73C58270R	ACXA73C58280R	O
	32	REACTOR	1	G0C592J00005	←	O
	33	ELECTRO MAGNETIC SWITCH	1	CWA001023	←	O
	34	TERMINAL COVER	1	CWH171039A	←	
	35	NUT - TERMINAL COVER	1	CWH7080300J	←	
	36	FAN MOTOR BRACKET	1	ACXD54K02150	←	
	37	SCREW-FAN MOTOR BRACKET	4	CWH551040J	←	
	38	FAN MOTOR	1	EHDS80C60AC	←	O
	39	SCREW-FAN MOTOR MOUNT	4	CWH551323	←	
	40	PROPELLER FAN ASSY	1	CWH00K1006	←	
	41	NUT	1	CWH561092	←	
	42	CABINET FRONT PLATE	1	ACXE06-03400A	←	
	43	DISCHARGE GRILLE	1	CWE201154	←	
	44	CABINET SIDE PLATE ASSY	1	CWE04K1019A	←	
	45	WIRE NET	1	CWD041059	←	
	46	HIGH PRESSURE SWITCH	1	CWA101013	←	
	47	ACCESSORY CO.(RUBBER CAP)	1	CWH82C1839	←	

SAFETY	REF. NO.	DESCRIPTION & NAME	QTY.	WH-MDC07J3E5	WH-MDC09J3E5	REMARK
	48	ACCESSORY CO.(DRAIN ELBOW)	1	CWG87C900	←	
	49	RECEIVER	1	ACXB14-00670	←	
⚠	50	SENSOR-COMPLETE	1	CWA50C3379	←	O
⚠	51	BASE PAN HEATER	1	CWA341071	←	O
	52	HOT WATER COIL-COMPLETE	1	ACXB90C00960	←	
	53	FILTER COMPLETE	1	ACXB51C00100	←	
⚠	54	HEATER ASS'Y	1	ACXA34K00240	←	O
⚠	55	THERMOSTAT	2	CWA151074	←	O
	56	TERMINAL COVER	1	CWH171051	←	
	57	FLOW SENSOR	1	ACXB62-00911	←	
⚠	58	PUMP	1	ACXB53-00390	←	O
	59	PRESSURE GAUGE	1	CWB070003	←	
	60	AIR PURGE VALVE	1	ACXB62-00130	←	
	61	PRESSURE RELIEF VALVE	1	ACXB62-00740	←	
	62	CABINET SIDE PLATE	1	ACXE04-11720A	←	
⚠	63	ELECTRONIC CONTROLLER (MAIN) - WATER	1	ACXA73C58310R	ACXA73C58320R	O
	64	CIRCUIT BREAKER	2	CWA181005	←	O
⚠	65	REACTOR	1	G0C103Z00003	←	O
⚠	66	TERMINAL BOARD ASS'Y(1,2,3,4,5,6)	1	CWA28K1341	←	O
⚠	67	TERMINAL BOARD ASS'Y(7,8,9,10,11,12)	2	CWA28K1340	←	O
⚠	68	TERMINAL BOARD ASS'Y(13,14,15,16,17,18)	3	CWA28K1343	←	O
⚠	69	TERMINAL BOARD ASS'Y(A,B)	1	CWA28K1238	←	O
⚠	70	SENSOR-COMPLETE(WATER IN,OUT, REF TEMP)	1	ACXA50C06750	←	O
⚠	71	SENSOR-COMPLETE(HEX WATER OUTLET)	1	ACXA50C06660	←	O
⚠	72	REMOTE CONTROL COMPLETE	1	ACXA75C15750	←	O
	73	RECEIVER	1	CWB141066	←	
	74	HANDLE	4	CWE161021	←	
	75	SOUND PROOF MATERIAL	1	ACXG30-10210	←	
	76	CABINET FRONT PLATE CO.	1	ACXE06C03790	←	
	77	CABINET FRONT PLATE	1	ACXE06-04500A	←	
	78	CABINET TOP PLATE CO.	1	ACXE03C01980	←	
	79	OPERATING INSTRUCTION	1	ACXF55-26660	←	
	80	OPERATING INSTRUCTION	1	ACXF55-26670	←	
	81	OPERATING INSTRUCTION	1	ACXF55-26680	←	
	82	OPERATING INSTRUCTION	1	ACXF55-26690	←	
	83	OPERATING INSTRUCTION	1	ACXF55-26700	←	
	84	OPERATING INSTRUCTION	1	ACXF55-26710	←	
	85	OPERATING INSTRUCTION	1	ACXF55-27620	←	
	86	INSTALLATION INSTRUCTION	1	ACXF60-38370	←	
	87	INSTALLATION INSTRUCTION	1	ACXF60-38380	←	
	88	PANASONIC BADGE	1	CWE373439	←	
	89	INVERTER BADGE	1	CWE373441	←	
	90	PACKING-L.TUBE	1	CWB81012	←	
	91	CONNECTING BAR	1	CWE261213A	←	
	92	CONNECTING BAR	1	CWE261214A	←	
	93	GASKET FOR TERMINAL COVER	1	CWB811177	←	
	94	HOLDER COUPLING	1	ACXH35-01880A	←	

SAFETY	REF. NO.	DESCRIPTION & NAME	QTY.	WH-MDC07J3E5	WH-MDC09J3E5	REMARK
	95	BAG	1	CWG861483	←	
	96	SHOCK ABSORBER	2	CWG713660	←	
	97	SHOCK ABSORBER	2	CWG713661	←	
	98	SHOCK ABSORBER	2	CWG713662	←	
	99	BASE BOARD-COMPLETE	1	ACXG62C02080	←	
	100	C.C.CASE	1	ACXG50-55100	←	
	101	MODEL LABEL	2	ACXF85-31570	ACXF85-31580	
	102	FLAT PLATE	2	ACXD64-00400A	←	

**Note:**

- All parts are supplied from PAPAMY, Malaysia (Vendor Code: 00029488).
- "O" marked parts are recommended to be kept in stock.