



# Safety Instructions



0,1,4,6,7,8,9,11,15,  
17,19,20,22,25



Info Hotline  **+49 (0) 5041 998 389**  
Mon. - Do. 7<sup>00</sup> - 20<sup>00</sup>  
Fr. 7<sup>00</sup> - 17<sup>00</sup>

Paulmann Licht GmbH  
31832 Springe / Germany  
www.paulmann.com

Art.-Nr.:  
**926.19**  
**926.23**

(+MA 173)

PEV 05/13 

926.19

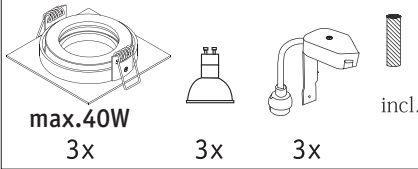

926.23

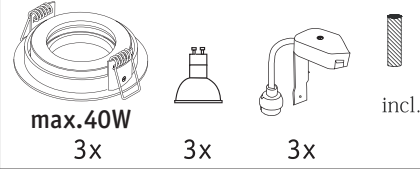

incl.  
3x4W  
GU10



Paulmann  
Art.-Nr.281.44

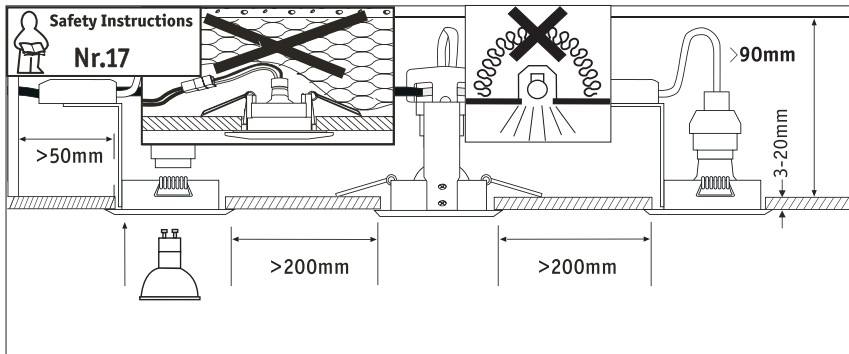
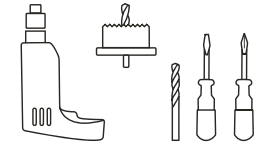

Safety Instructions  
Nr. 25

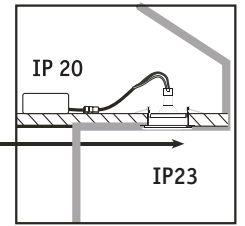
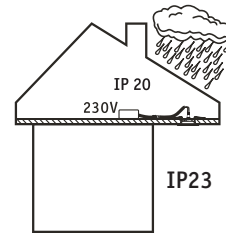

A Safety Instructions  
Nr. 0, 1



(Ø 82mm)

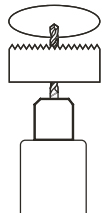

B Safety Instructions  
Nr.0,4

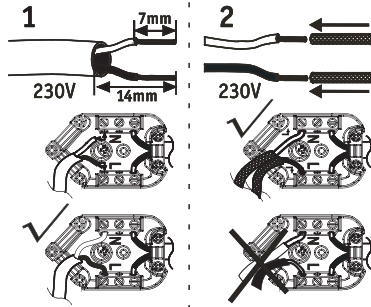

C

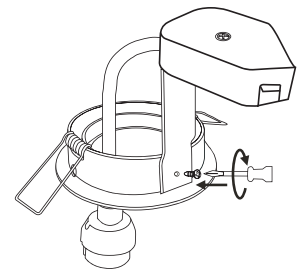

D

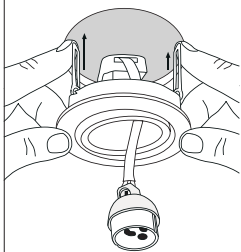

E



F



G



H

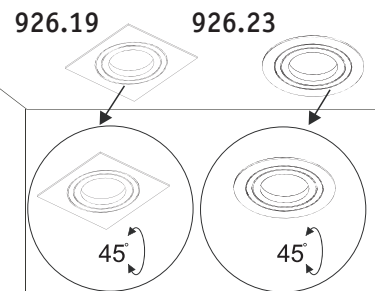

I

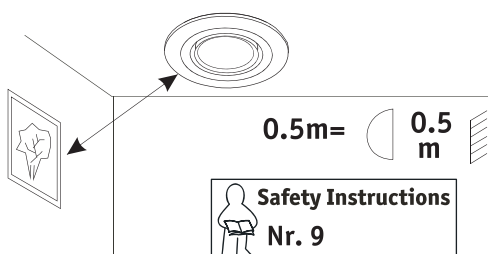

A, B, C, D, E,  
F, G, H, I

max.40W

