

Safety Instructions



0,1,2,4,5b,7,8,9,11,
12,15,16,17,19,20,21,
22,23,29



Info Hotline

+49 (0) 5041 998 389

Mon. - Do. 7⁰⁰ - 20⁰⁰

Fr. 7⁰⁰ - 17⁰⁰

Paulmann Licht GmbH
31832 Springe / Germany
www.paulmann.com

Art.-Nr.:
507000319

(+MA 173)

PBO 08 / 09

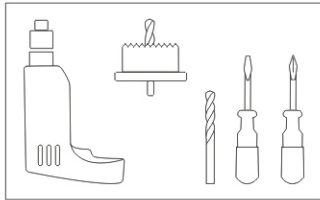

B



C

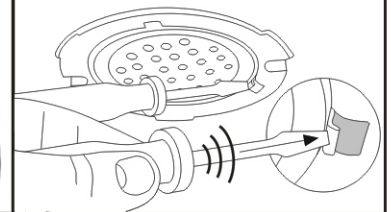
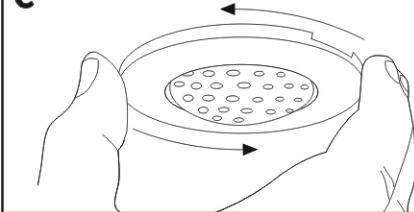

A

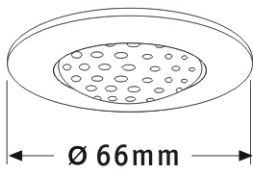

B

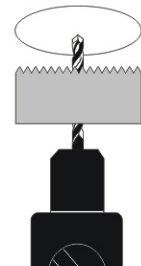

C

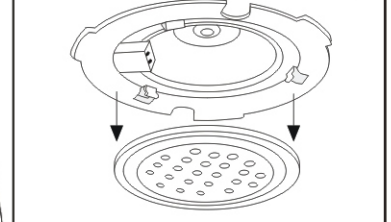
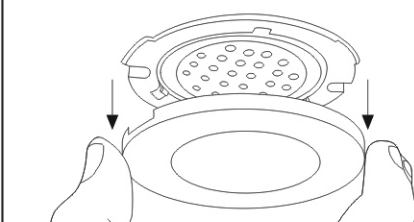

D

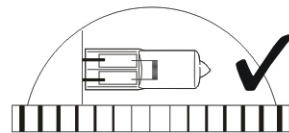
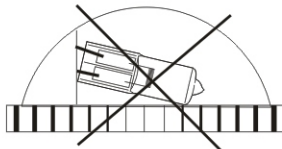
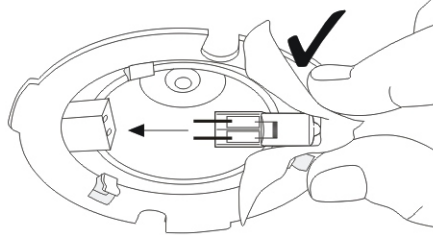
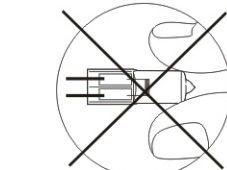

E

„CLICK“

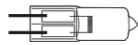
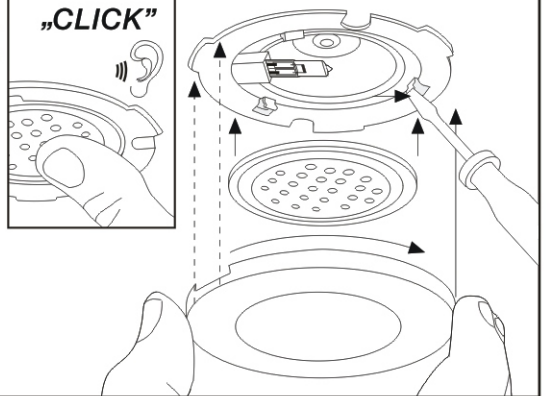

10W G4 831.109
20W G4 831.209

F

12V

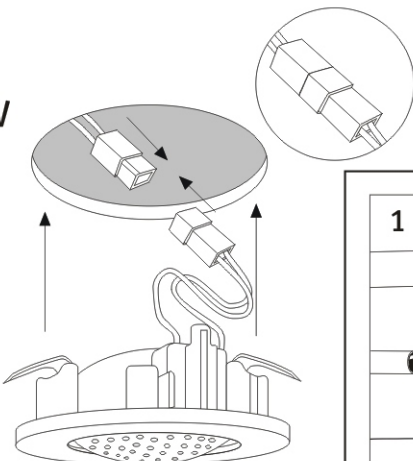

1

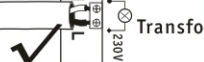
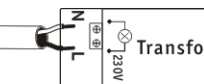
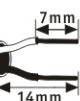

2

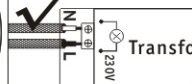
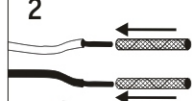

G

