

Lekstuga Lido
Art.Nr. 284799
1/10



8.03.2018

Art.Nr. 284799

1:100

Fasader och grundplan - Visningar og grunnplan - Tegninger og grundplan - Julkisivut ja pohjapiirustus

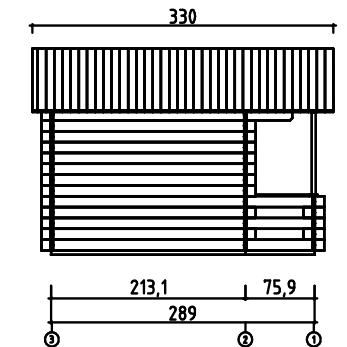
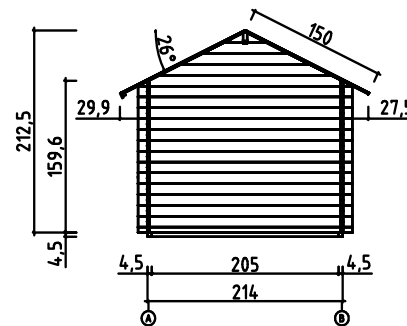
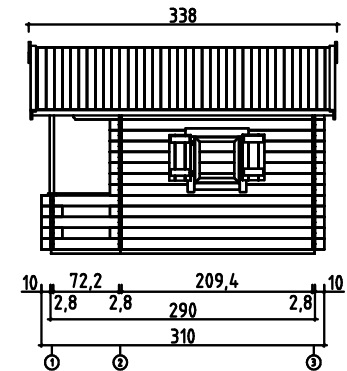
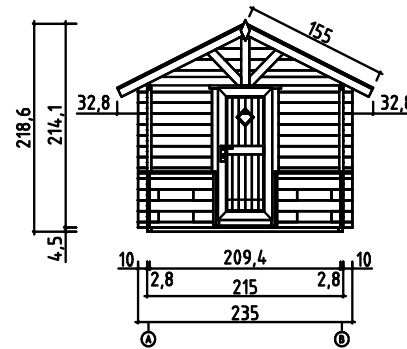
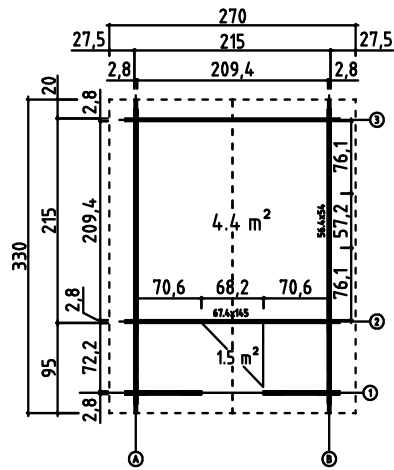

Art.Nr. 284799

Planritning - Grunnplan - Grundplan - Pohjapiirustus

Tåkasar - Takbjelke - Tagbjælke - Katto-orret

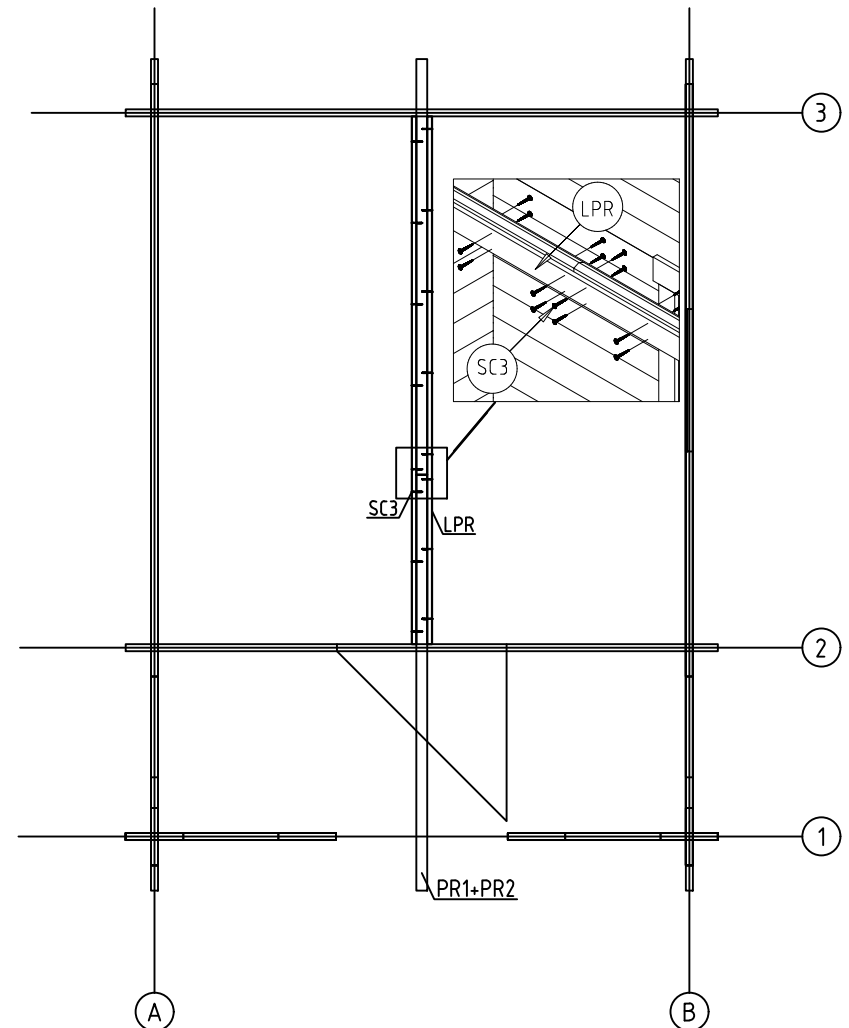
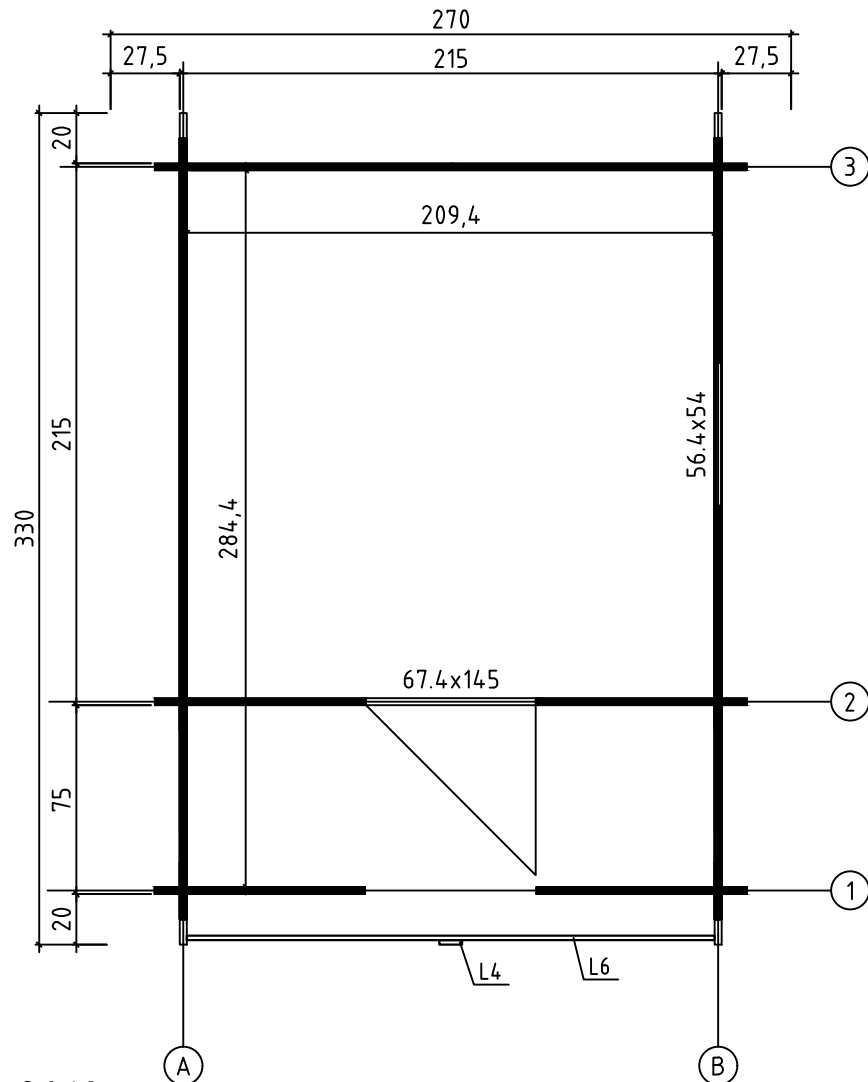

08.03.2018

3/10

Art.Nr. 284799

Grund - Grunnmur - Fundament - Perustus

Golvbrädor - Gulvbord - Gulvbrædder - Lattialaudat

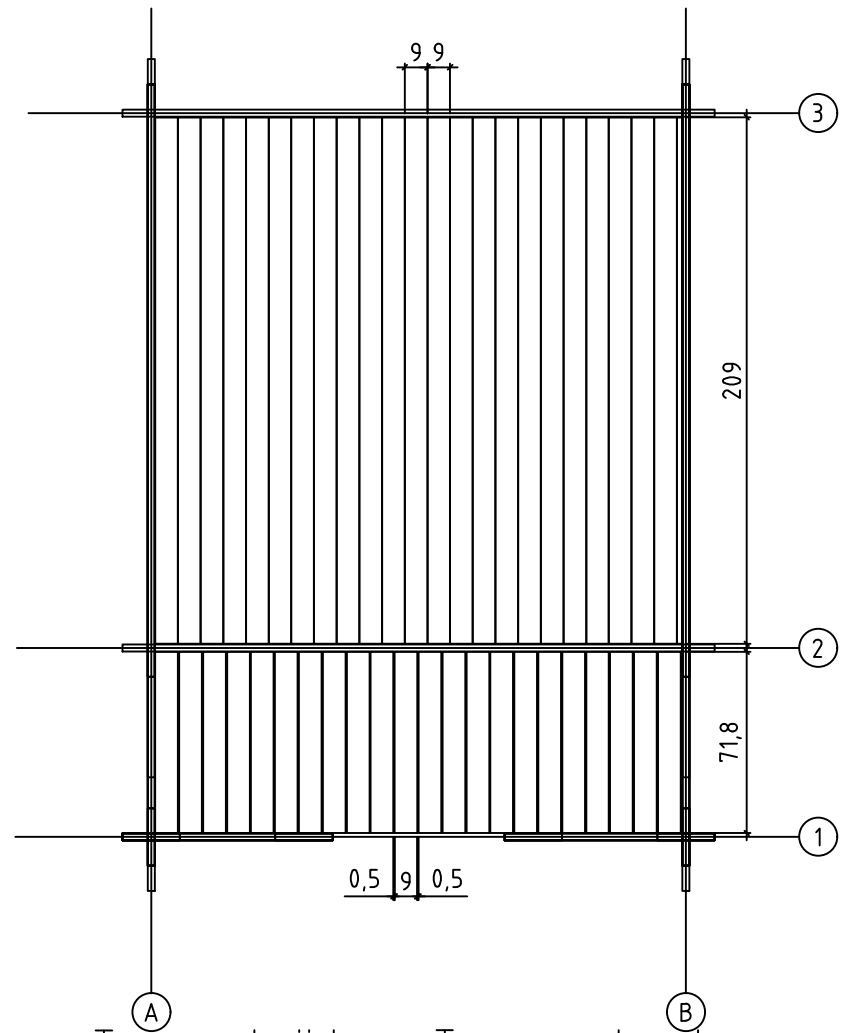
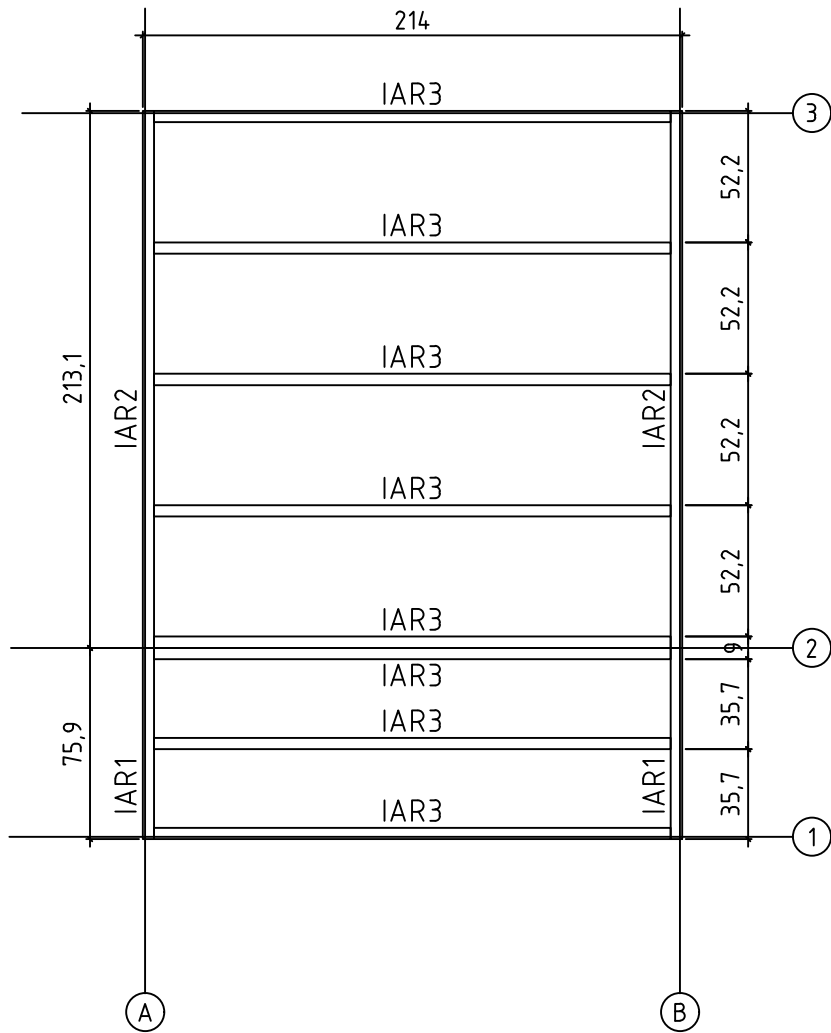

08.03.2018





Terrassbrädor - Terrassebord -
Terrassebrædder - Terassilauta

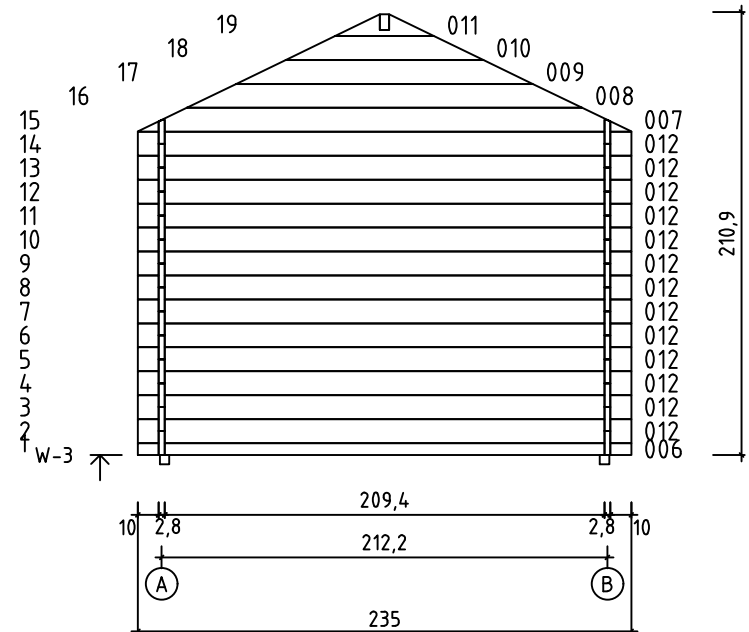
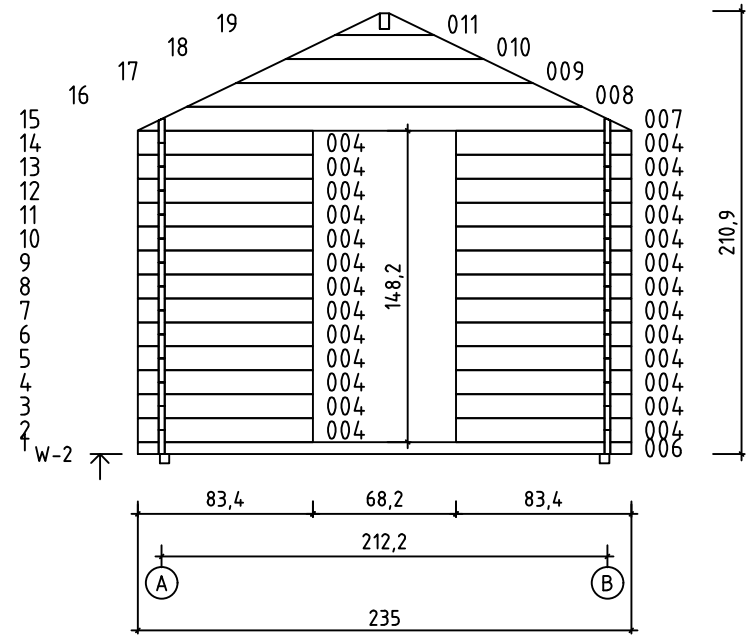
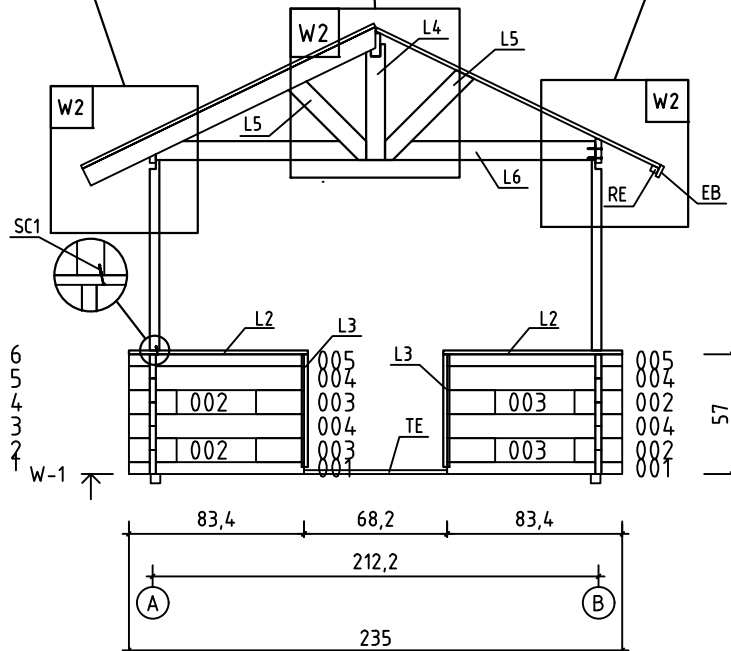
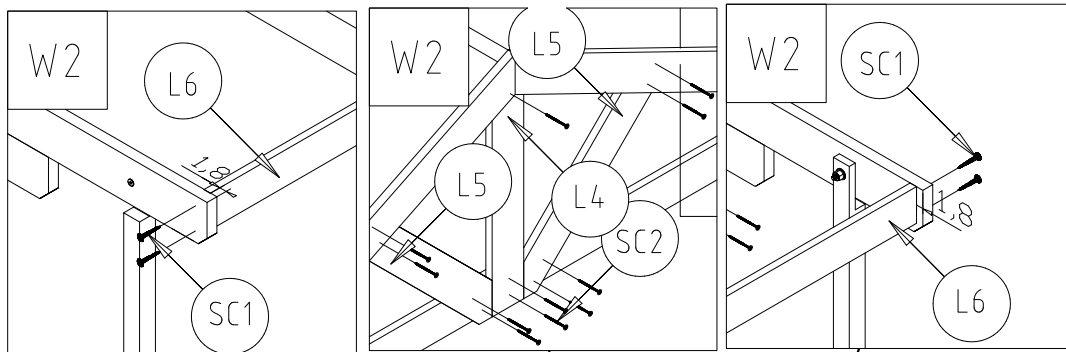

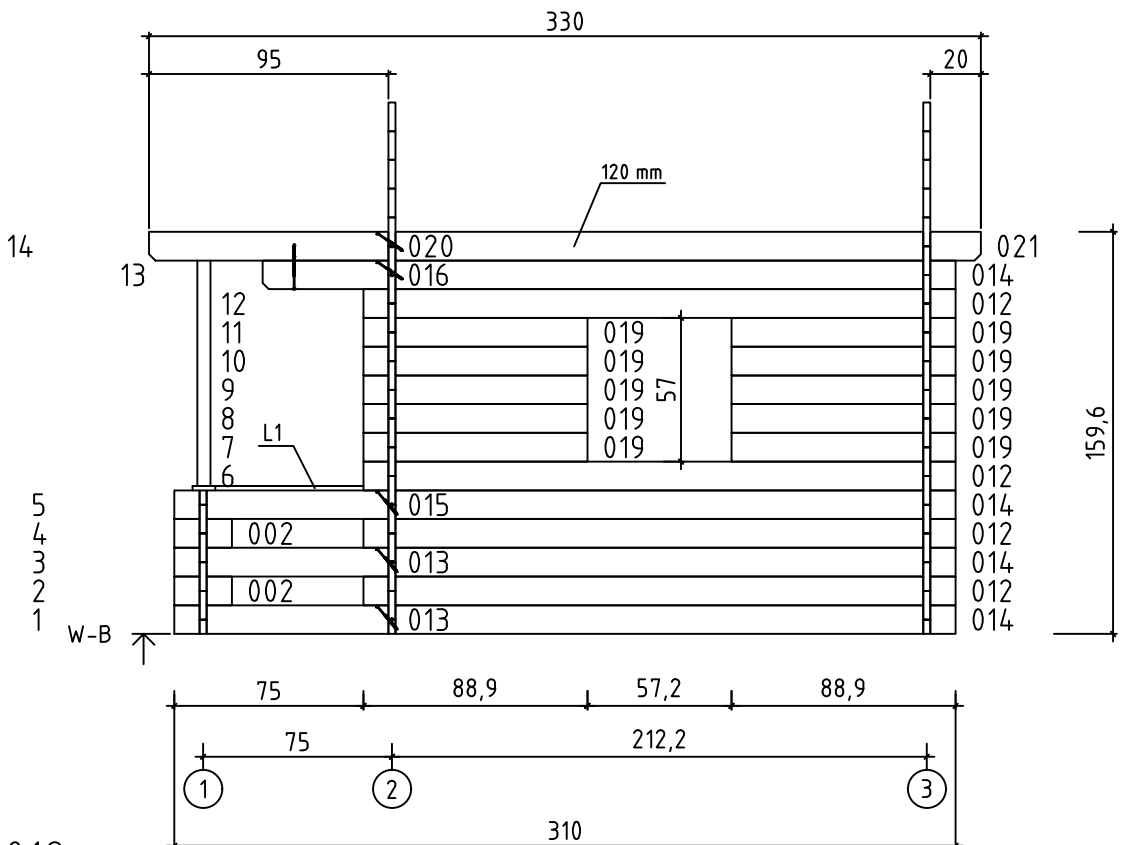
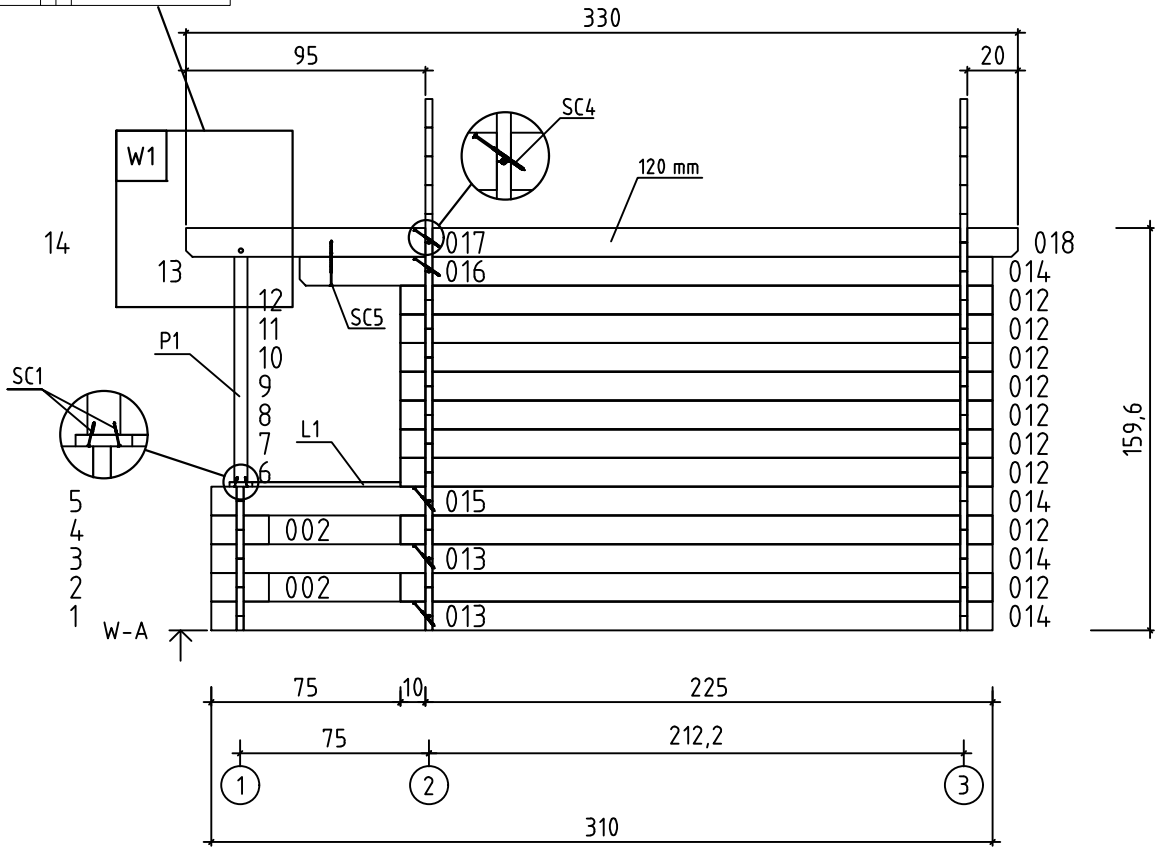
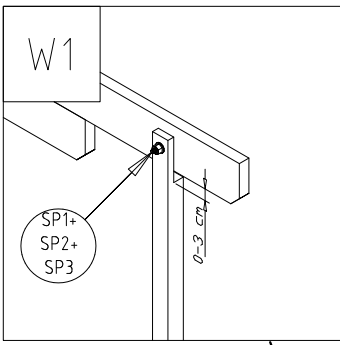

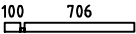

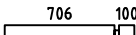
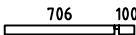
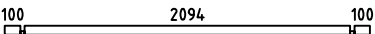
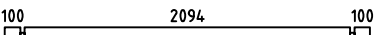
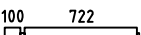
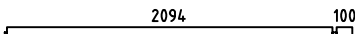
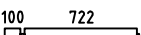

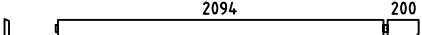
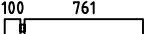
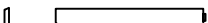
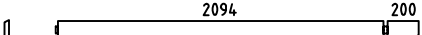
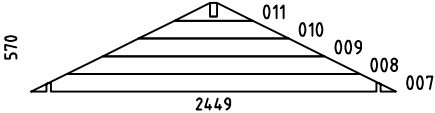
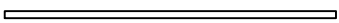
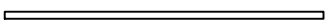
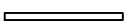
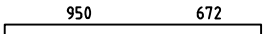
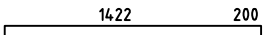





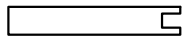
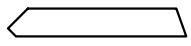
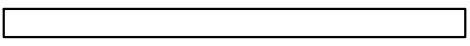
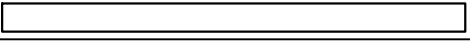
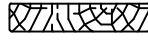

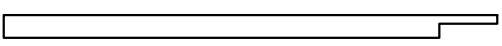
4 / 10

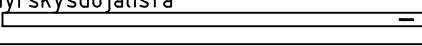

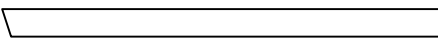







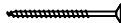
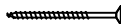
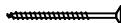
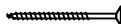
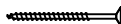
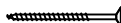





Art.Nr. 284799







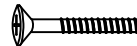

Pos	08.03.2018 Delförteckning - Liste over deler - Stykliste - Osaluettelo Art.Nr. 284799	7/10	Q	P (mm)	L (mm)
001			2	28x57	834
002			8	28x114	228
003			4	28x114	228
004			30	28x114	834
005			2	28x57	834
006			2	28x57	2350
012			26	28x114	2350
013			4	28x114	864
014			8	28x114	2236
015			2	28x114	864
016			2	28x114	514
017			1	28x120	964
018			1	28x120	2336
019			10	28x114	889
020			1	28x120	964
021			1	28x120	2336
W2-1 W3-1			1 1		
IAR2	Grund - Grunnmur - Fundament - Perustus 		2	45x45	2131
IAR3	Grund - Grunnmur - Fundament - Perustus 		8	45x45	2050
IAR1	Grund - Grunnmur - Fundament - Perustus 		2	45x45	759
A-PR1	Tåkasar - Takbjelke - Tagbjælke - Katto-orret 		1	44x120	1650
A-PR2	Tåkasar - Takbjelke - Tagbjælke - Katto-orret 		1	44x120	1650

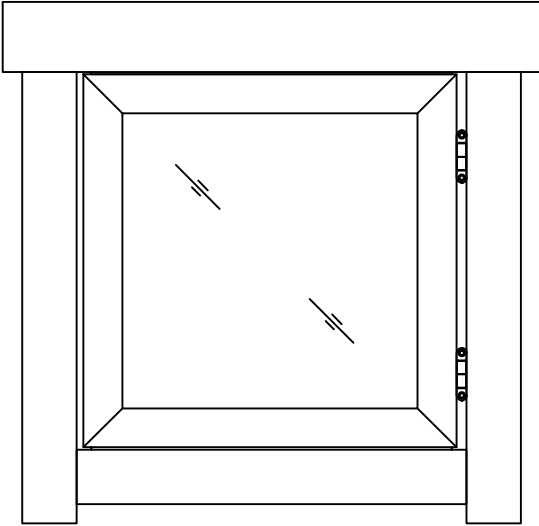
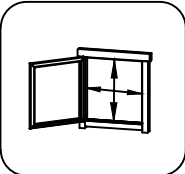
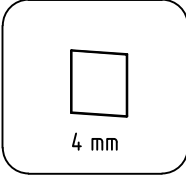
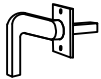
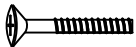

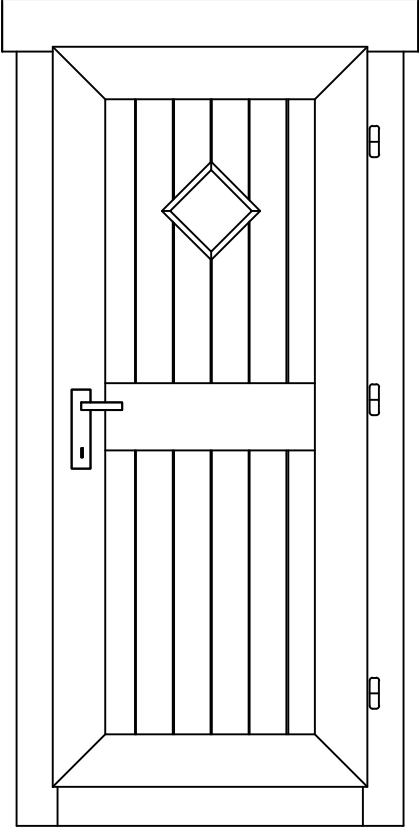
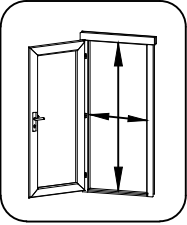
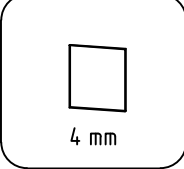
Pos	08.03.2018 Delförteckning - Liste over deler - Stykliste - Osaluettelo Art.Nr. 284799	8/10	Q	P (mm)	L (mm)
	Golvbrädor - Gulvbord - Gulvbrædder - Lattialaudat		24	90x18	2090
	Terrassbrädor - Terrassebord - Terrassebrædder - Terrasilauta		22	90x19	718
	Takbräde - Takbord - Tagbrædder - Kattolauta		74	90x18	1500
	Golvläkt - Gulvlist - Gulvliste - Jalkalista			18x18	8.36
	Takläkt - List for takpapp - Tagpapliste - Kattohuopalista		4	18x58	1550
L4	Takstötta - Takbjelke - Tagstøtte - Kattotuki		1	18x90	552
L5	Takstötta - Takbjelke - Tagstøtte - Kattotuki		2	18x90	574
L6	Takstötta - Takbjelke - Tagstøtte - Kattotuki		1	18x90	2094
LPR	Stötta för takbjälke - Understøttelse for takbjelke - Tagbjælkestøtte - Kattopalkin tuki		2	18x90	2094
EB	Takfotsinklädnad - Speilbord - Sternbræt - Rästäslista		4	18x58	3300
RE	Takfot - Forsterkning av takforkant - Tagkantsforsterkning - Rästäslista		4	28x34	3300
TE	Terrassbrädor - Terrassebord - Terrassebrædder - Terrasilauta		1	19x28	680
P1	Stolpe - Søyle - Stolpe - Pilari		2	44x44	980
L1	Skyddsräcke för terrass - Terrasserekverk - Gelænder til terrasse - Terassin kaide		2	18x90	588
L2	Skyddsräcke för terrass - Terrasserekverk - Gelænder til terrasse - Terassin kaide		2	18x90	853
KFS-1	Storm säkring - Vindavstivningslist - Stormliste - Myrskysuojalista		4	22x45	2050
L3	U-profil - U-profil - U-profil - U-profiili		2	28x58	537
GL	Vindbräde - Vindski - Vindskede - Kaapelilauta		4	18x90	1550
HS8	Skruv för gavelsegment - Skrue for gavledel - Skrue til gavlsegment - Koristepalan ruuvi		4	3.5x35	
HS9	Skruv för gavelläkt - Skrue for vindski - Skrue til vindskede - Harjalistan ruuvi		16	3.5x50	
SC2	Skruv för stolpe - Skrue for søyle - Skrue til stolpe - Pilarin ruuvi		12	3x35	
HS14	Skruv för u-profil - Skrue for u-profil - Skrue til u-profil - U-profiilin ruuvi		4	4.5x80	
SC3	Skruv till stötta till takbjälke - Skrue for festing av understøttelse for takbjelke - Skrue til at fastgøre tagbjælkestøtte - Kattopalkin tuen ruuvi		32	4x40	

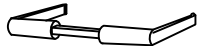
Pos	08.03.2018 Delförteckning - Liste over deler - Stykliste - Osaluettelo Art.Nr. 284799	9/10	Q	P (mm)	L (mm)
HS12	Skruv för takfotsinklädning - Skruer for speilbord - Skruer til sternbrædder - Rästälslaudan ruuvi		16	4x40	
HS12	Skruv för förstärkningsreglar till takfot - Skruer for forsterkning av takforkant - Skruer til tagkantsforsterkning - Kafon reunan vahvistusruuvi		16	4x40	
HS12	Skruv för kantbräda till terrass - Skruer for terrassens kantbord - Skruer til kantbræt til terrassen - Terassin reunalaudan ruuvi		3	4x40	
HS12	Skruv för terrassräcken - Skruer for terrassebord - Skruer til terrassens bagerste brædder - Terassin kaiteen laudan ruuvi		10	4x40	
SC1	Skruv för stolpe - Skruer for søyle - Skruer til stolpe - Pilarin ruuvi		12	4x60	
HS18	Skruv för takbjälkar - Skruer for takbjelker - Skruer til tagbjælker - Kattopalkin ruuvi		6	5x120	
SC4	Skruv för väggdetaljer - Skruer for veggmontasje - Skruer til vægrejsning - Seinäosien ruuvi		10	5x120	
HS16	Skruv för 1. väggregel - Skruer for første stokklag - Skruer til første vægbjælke - 1. seinäpalkin ruuvi		8	5x90	
HS16	Skruv för grund - Skruer for grunnmur - Skruer til fundament - Perustuksen ruuvi		16	5x90	
HS16	Skruv för grund - Skruer for grunnmur - Skruer til fundament - Perustuksen ruuvi		2	5x90	
SC5	Skruv för väggdetaljer - Skruer for veggmontasje - Skruer til vægrejsning - Seinäosien ruuvi		2	6x180	
NF2	Zn spik för golvläkt - Sinkstift for gulvlist - Zn søm til gulvliste - Sinkitty naula jalkalistan asennukseen		17	1.4x40	
SP3	Bricka för strömsäkring - Skive for vindavstivningslist - Skive til stormliste - Myrskysuojalistan aluslaatta		10	D6	
	Hammarkloss - Hoggestabbe - Træklods til hamring - Naulauskappale		1		
SP1	Mutter för strömsäkring - Mutter for vindavstivningslist - Møtrik til stormliste - Myrskysuojalistan mutteri		10	D6	
NF3	Förzinkad spik till terrass - Sinkspiker for terrasse - Zn søm til terrasse - Sinkitty terassinaula		132	2.1x50	
NF4	Förzinkad takspik - Sinkspiker for tak - Zn søm til tag - Sinkitty kattonaula		156	2x50	
NF4	Förzinkad golvspik - Sinkspiker for gulv - Zn søm til loft - Sinkitty lattianaula		125	2x50	
NF5	Förzinkad spik för takläkt - Sinkspiker for takpappliste - Zn søm til tagpapliste - Kattohuopalistin sinkitty naula		16	2x40	
SP2	Bult för strömsäkring - Bolt for vindavstivningslist - Bolt til stormliste - Myrskysuojalistan pultti		10	6x60	
GS	Gavelsegment - Gavledel - Gavlsegment - Koristepala		2		
	Fönster- Vindu - Vindue - Ikkuna			564x540 AK.1.100.SVP.l SGC	1
	Dörr- Dør-Dør-Ovi			674x1450 UK.2.020.SVP.b SGC	1

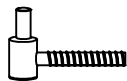
Pos	08.06.2015 Delförteckning - Liste over deler - Stykliste - Osaluettelo 564x540 AK.1.100.SVP.I SGC	1/1	Q	P (mm)	L (mm)
			 <p data-bbox="1369 353 1497 383">464x464 mm</p>  <p data-bbox="1410 517 1458 546">4 mm</p> <p data-bbox="1378 577 1497 607">396x396 mm</p>		
FS	Handtagsbeslag för fönster - Vridere til vinduer - Vindueshåndtag - Ikkunanpainikkeet			1	
FSP	Bult för handtagsbeslag till fönster - Bolt for vindusvridere - Bolt til vindueshåndtag - Ikkunanpainikkeen pultti			2	

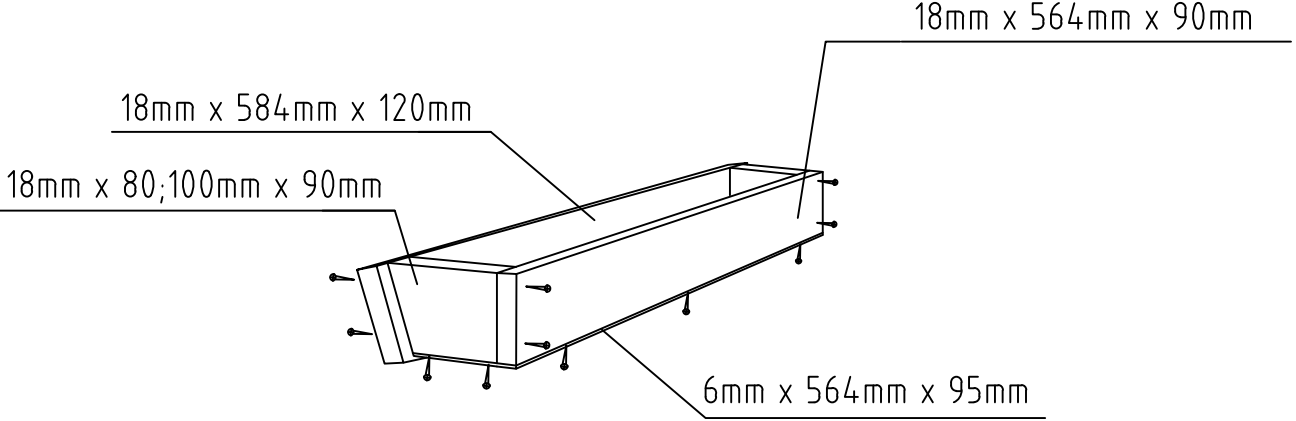
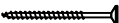
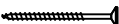
Pos	04.08.2014	Delförteckning - Liste over deler - Stykliste - Osaluettelo 674x1450 UK.2.020.SVP.b. SGC	1/1	Q	P (mm)	L (mm)
					 <p>574x1350 mm</p>	 <p>4 mm</p> <p>160x160 mm</p>
HS16	Skruv för dörrträskel - Skruer for terskel - Skruer til dørtrin - Kynnyksen ruuvi		4	5x90		
HS25	Skruv för dörrkarm - Skruer for dørstolpe - Skruer til dørkarm - Oven karmin ruuvi		2	5x90		
TL4	Handtag för dörr - Dørbeslag - Dørhåndtag - Ovenpainike		1			
TL5	Sats med täckbrickor för dörrlås - Et sett av dørbeslag - Sæt af låsedækler - Lukkokilpissarja		1			
	Cylinder - Sylindertilås - Cylinderlås - Sylinterilukko		1	30x35		
	Gångjärn för dörr - Bolt for dørhængsel - Hanskrue til dørhængsel - Oven sarana		3			

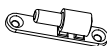
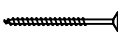
Pos	06.05.2013 Delförteckning - Liste over deler - Stykliste - Osaluettelo Art.Nr. 991200	1/1	Q	P (mm)	L (mm)
	<p data-bbox="263 129 917 161">Blomlåda - Blomsterkasse - Blomsterkasse - Kukkalaatikko</p>  <p data-bbox="370 645 726 683">18mm x 584mm x 120mm</p> <p data-bbox="258 721 635 759">18mm x 80;100mm x 90mm</p> <p data-bbox="1168 555 1513 593">18mm x 564mm x 90mm</p> <p data-bbox="957 922 1284 960">6mm x 564mm x 95mm</p>				
HS9	Skruv för blomlåda - Skruer for blomsterkasse - Skruer til blomsterkasse - Kukkalaatikon ruuvi		18	3.5x50	
HS12	Skruv för att fästa blomlådor mot väggarna - Skruer for festing blomsterkasse til veggen - Skruer til at fastgøre blomsterkasse til væggene - Kukkalaatikon seinäkiinnitysruuvi		2	4x40	

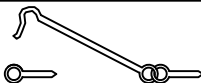
Pos	15.11.2012 Delförteckning - Liste over deler - Stykliste - Osaluettelo Art.Nr. 995100	1/1	Q	P (mm)	L (mm)
<p>Fönsterluckor 564x540 - Vinduslemmer 564x540 - Skodder 564x540 - Ikkunaluukut 564x540</p> <div data-bbox="619 371 1161 896" data-label="Image"> </div>					
1	Fönster - Hengsler til vindusskodder - Hængsel til skodder - Ikkunaluukun sarana 	4	D13x68		
2	Gångjärn för fönsterluckor - Hengsler til vindusskodder - Hængsel til skodder - Ikkunaluukun sarana 	4	D13x68		
3	Skruv för gångjärn till fönsterluckor - Skruer for vindushengsel - Skruer til skoddehængsel - Ikkunaluukun saranan ruuvi 	8	4x40		
4	Skrue til liste - Skruer for list - Skrev för läkt - Liston asennusruuvi 	2	3x30		
5	Bult till portgångjärn - Vinduskrok - Skoddekrog - Portin saranaan pultti 	3	60		