

Brighton 44
Art. Nr. 4416902
1/11



9.03.2018

Art.Nr. 4416902

1:100

Fasader och grundplan - Visningar og grunnplan - Tegninger og grundplan - Julkisivut ja pohjapiirustus

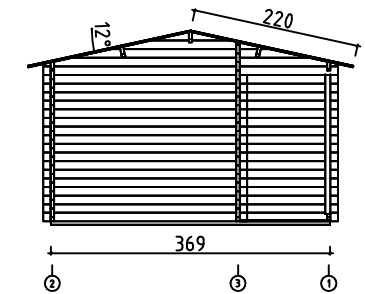
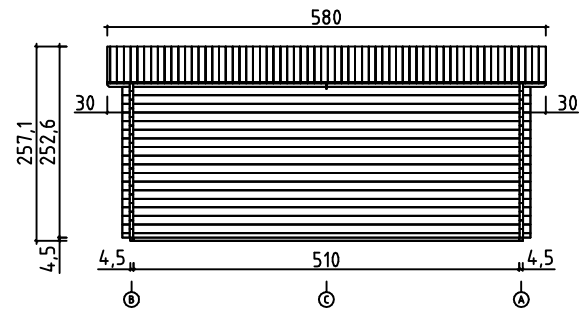
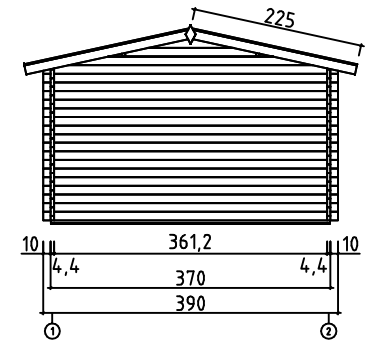
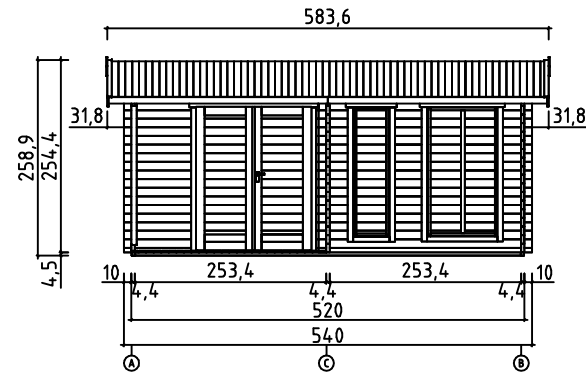
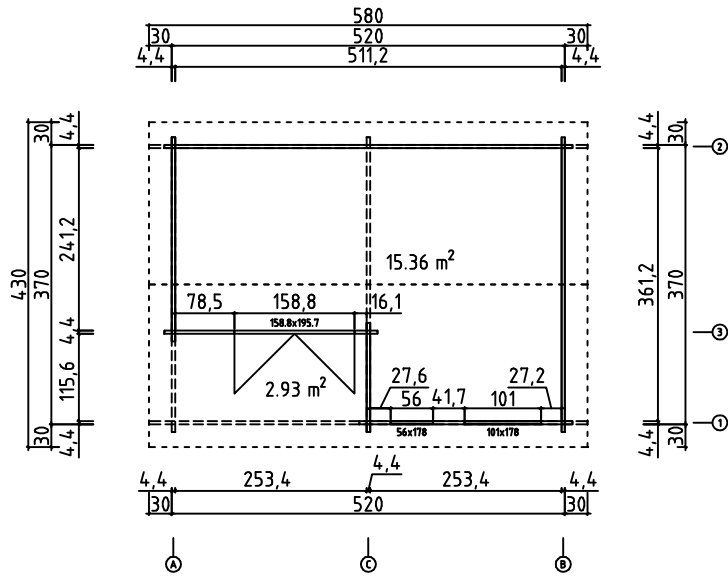

Art.Nr. 4416902

Planritning - Grunnplan - Grundplan - Pohjapiirustus

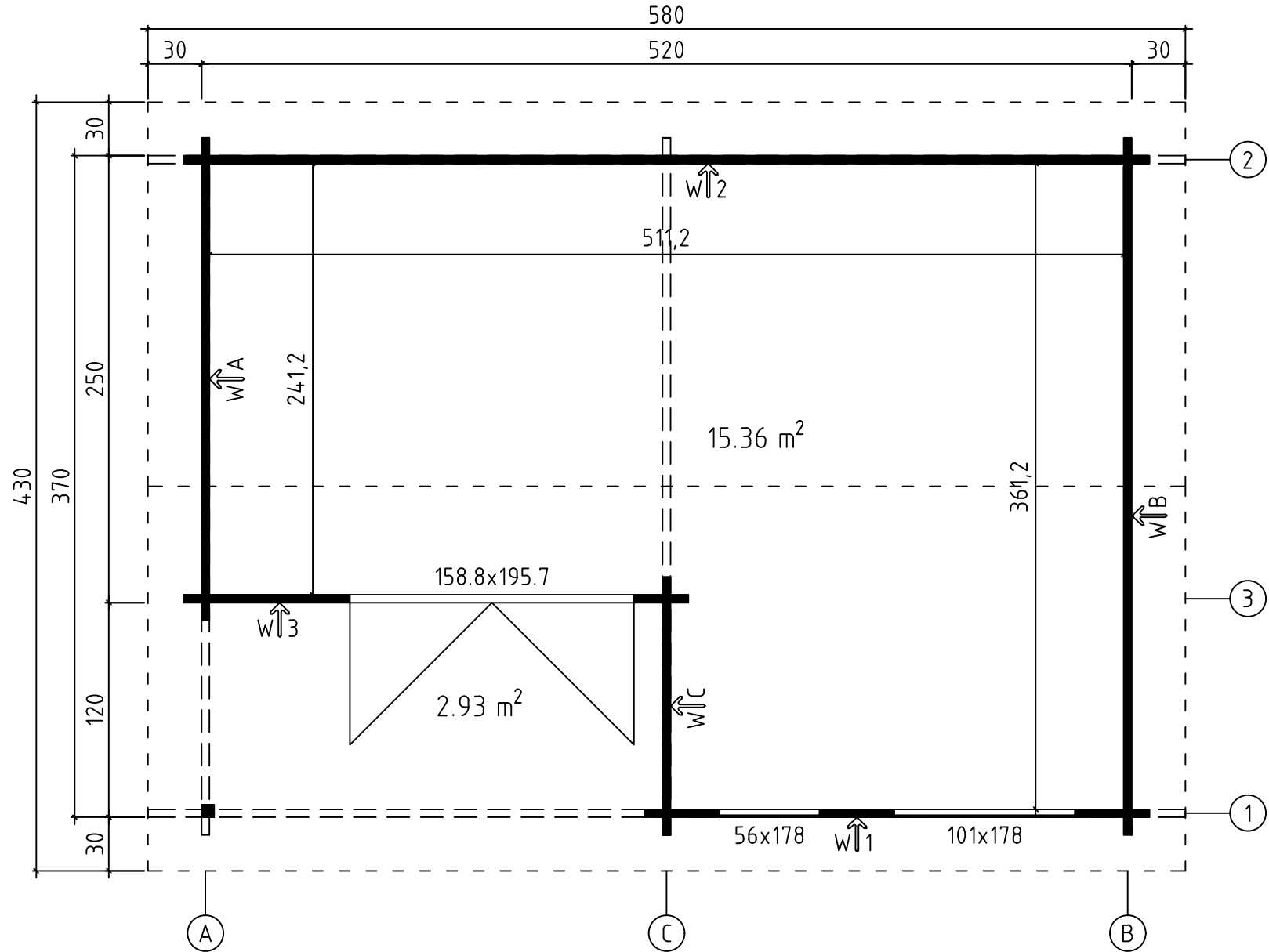

Art.Nr. 4416902

Grund - Grunnmur - Fundament - Perustus

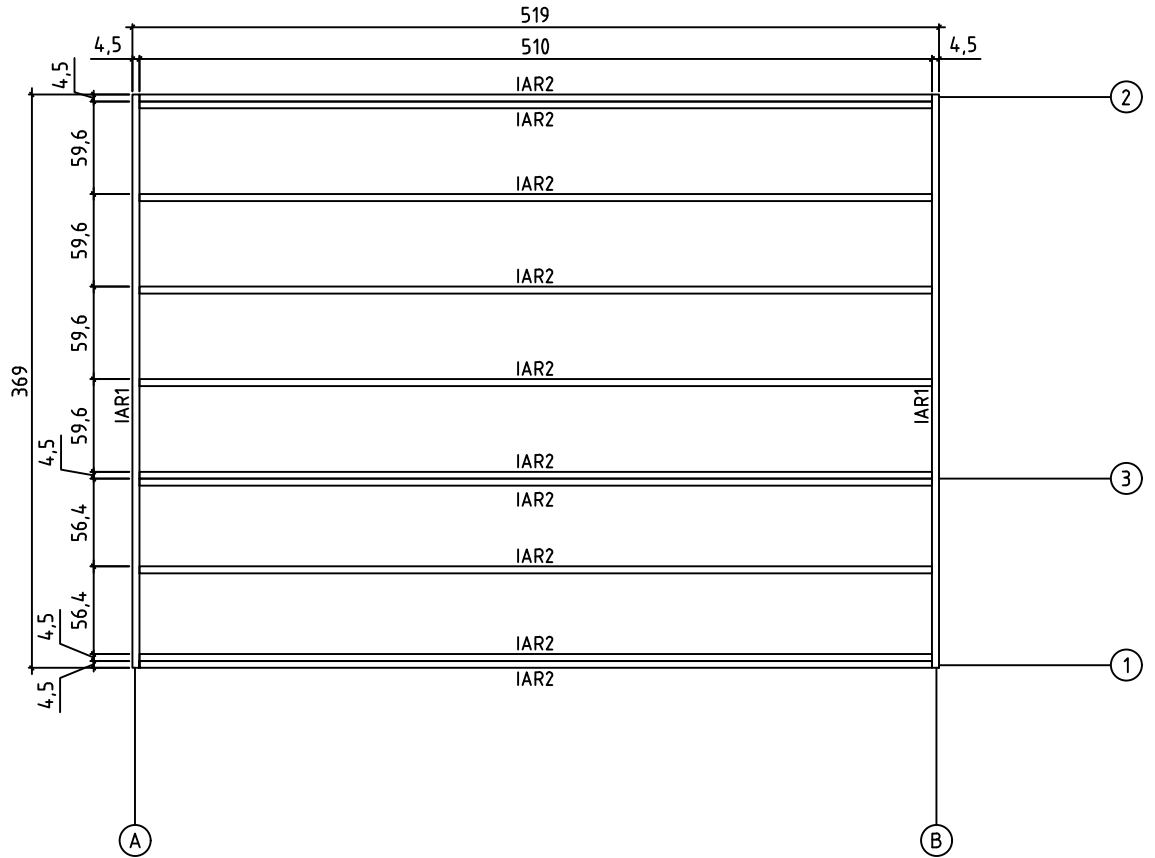

Golvbrädor - Gulvbord - Gulvbrædder - Lattialaudat

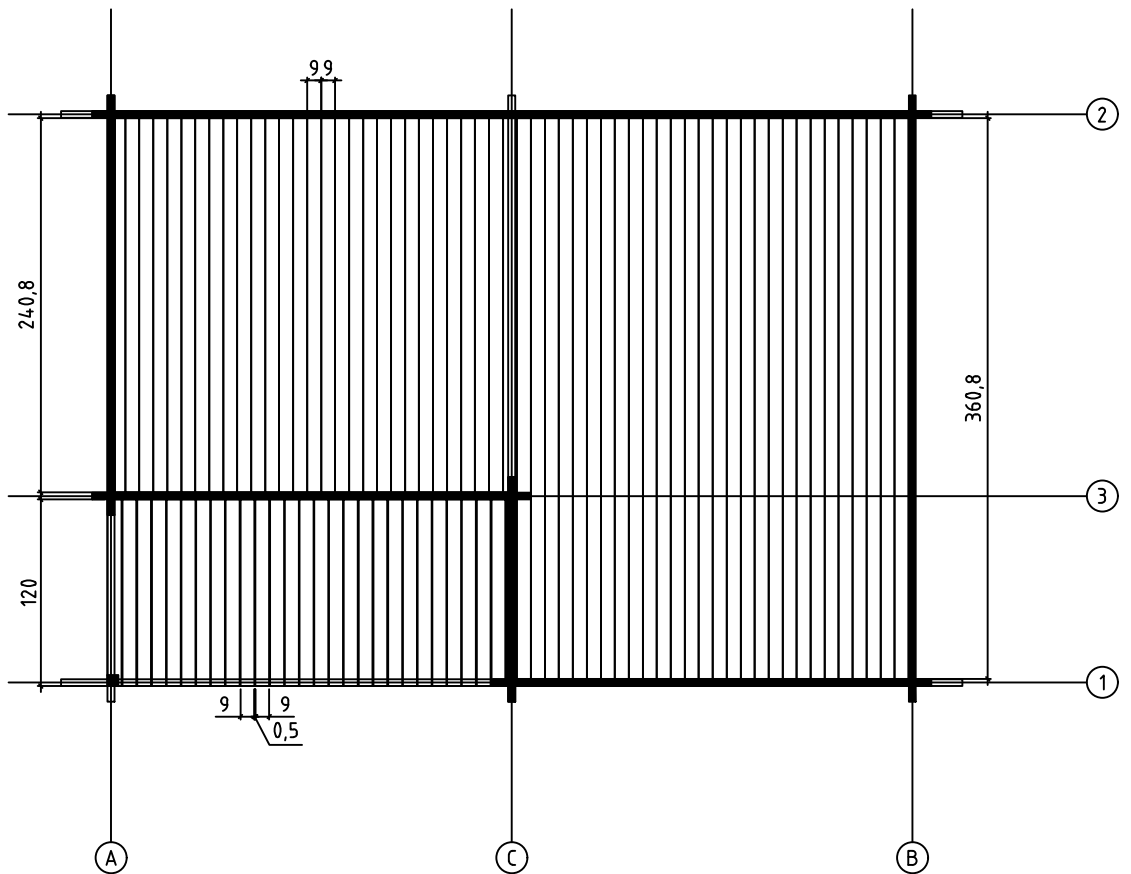

Terrassbrädor - Terrassebord - Terrassebrædder - Terrasilauta

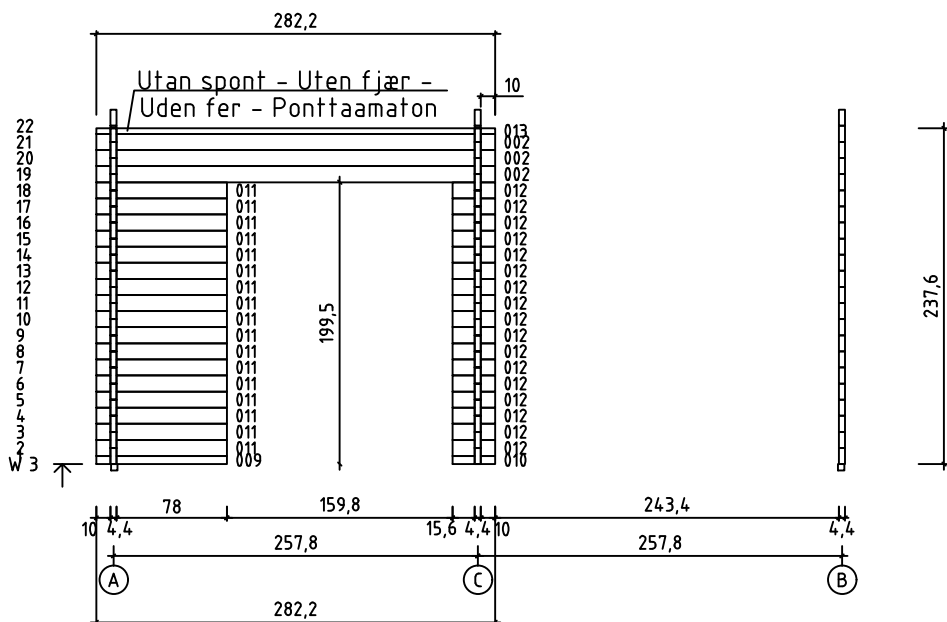
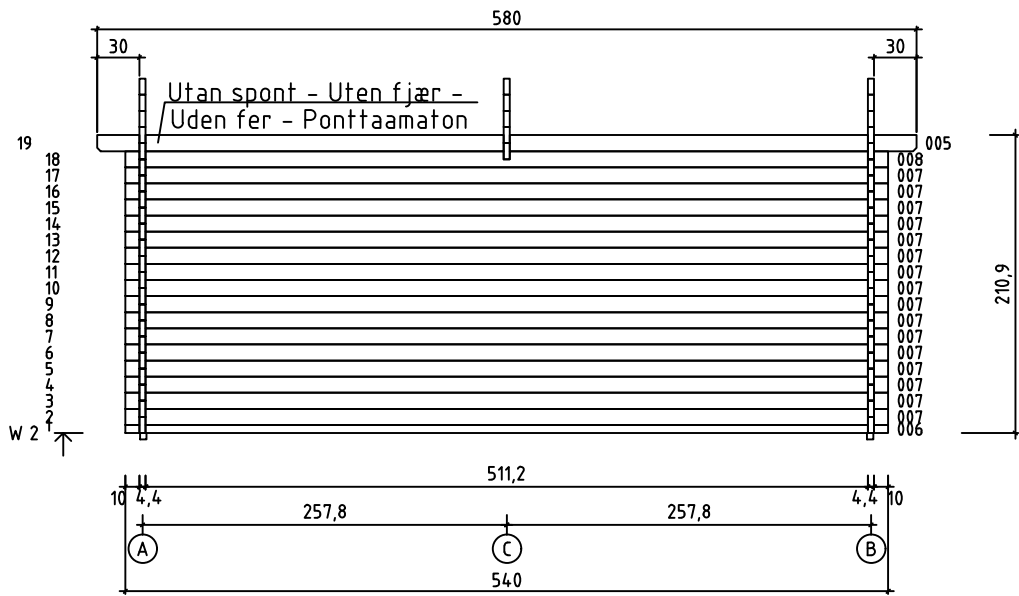
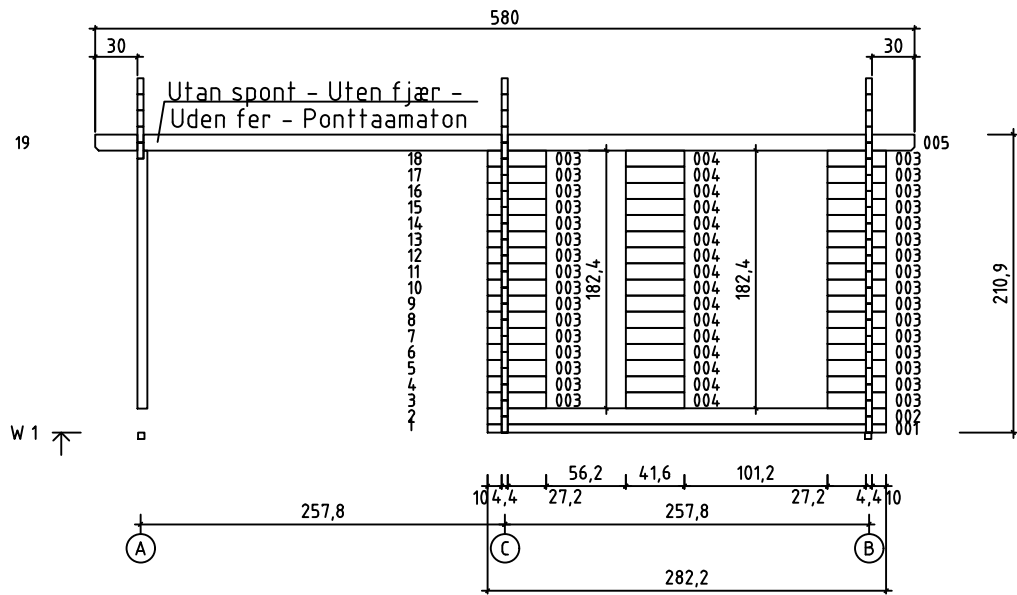

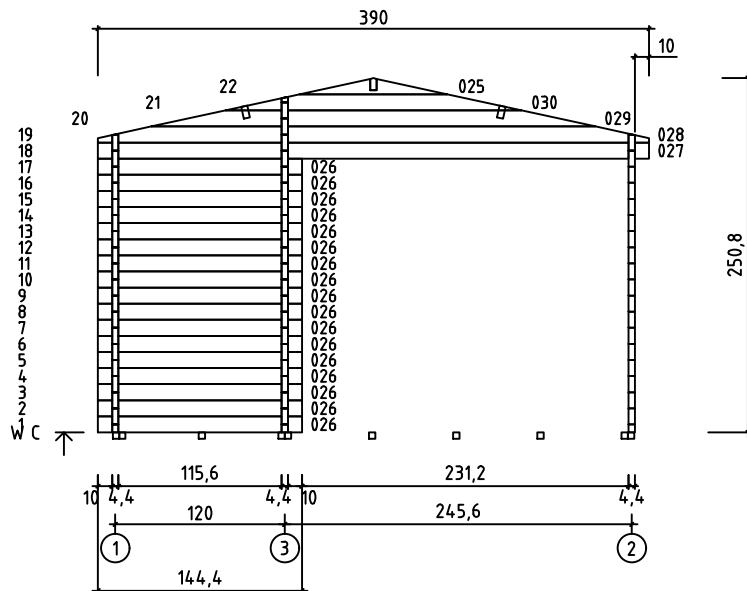
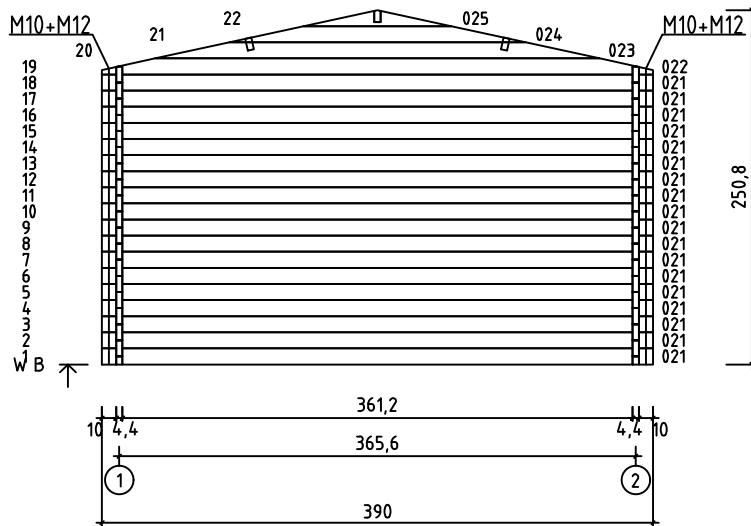
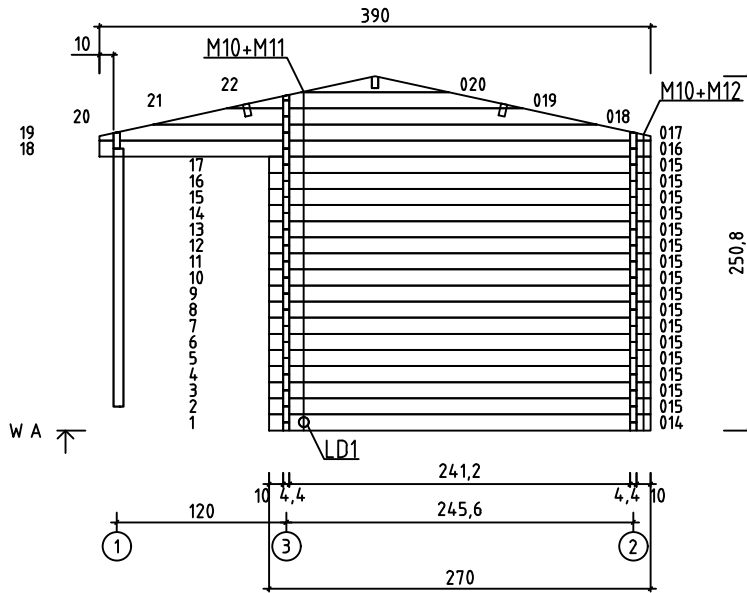

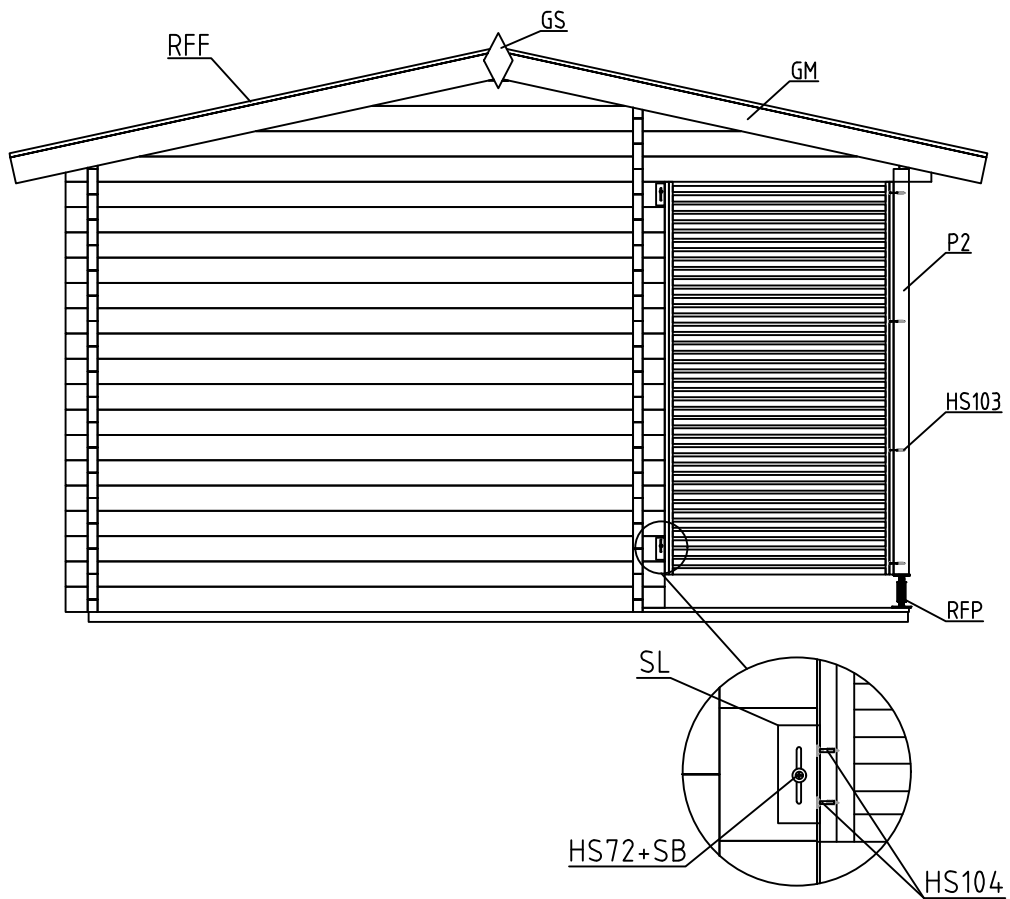



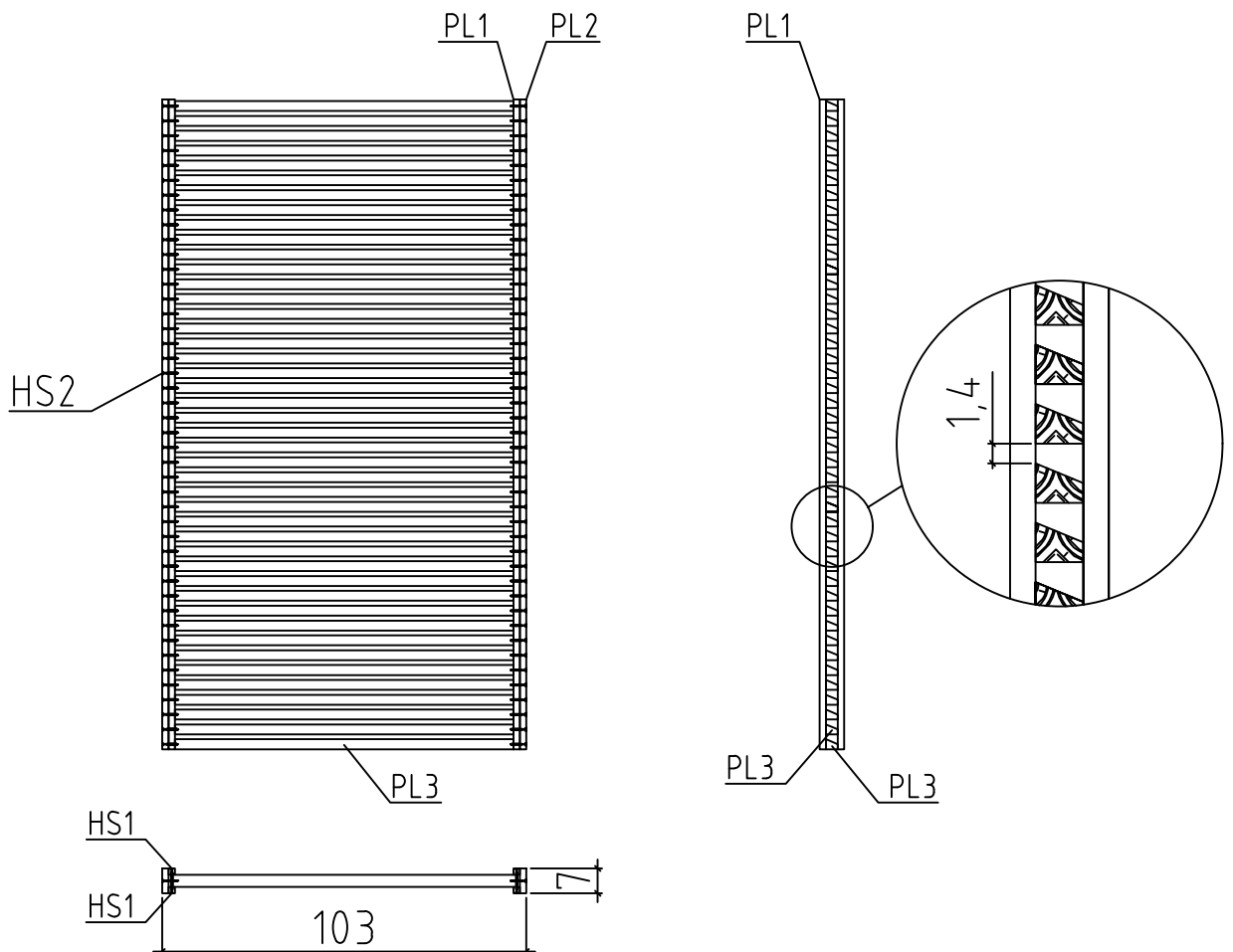

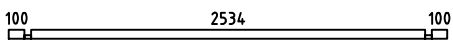
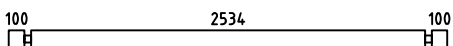

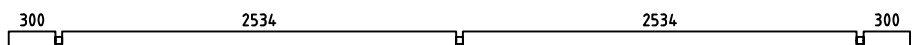
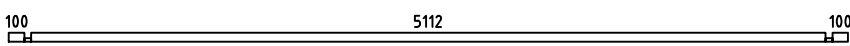
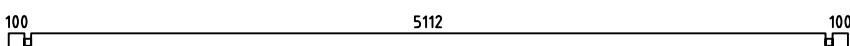
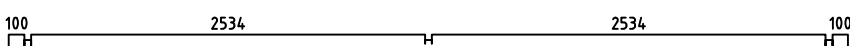
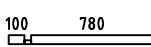

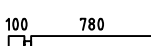

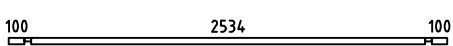
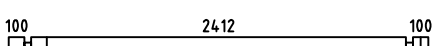
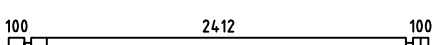
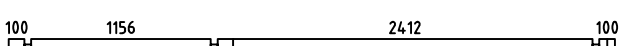
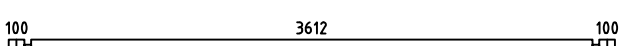
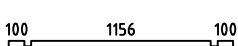
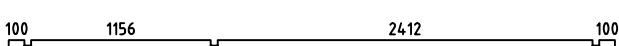
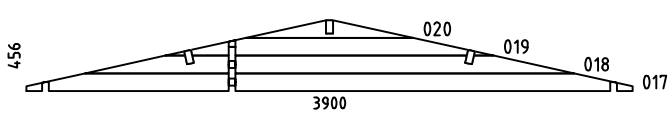
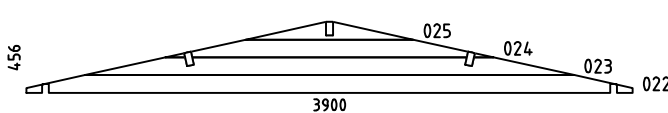

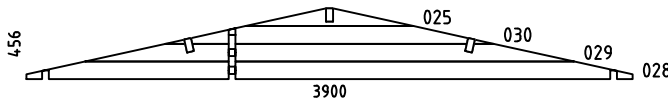
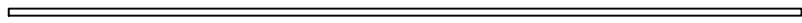
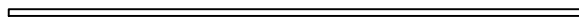
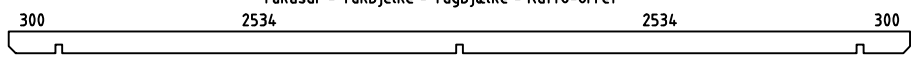







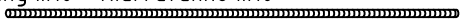

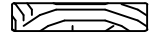

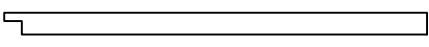
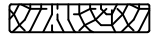

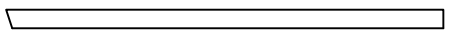
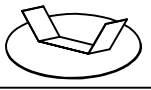
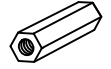

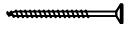



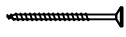

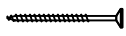

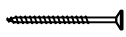
Terrassracke - Terrasserekkverk - Terrassegelander - Terrassikaide

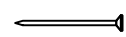

Pos	09.03.2018 Delförteckning - Liste over deler - Stykliste - Osaluettelo Art.Nr. 4416902	8/11	Q	P (mm)	L (mm)
001			1	44x57	2822
002			4	44x114	2822
003			32	44x114	416
004			16	44x114	416
005			2	44x120	5800
006			1	44x57	5400
007			16	44x114	5400
008			1	44x114	5400
009			1	44x57	924
010			1	44x57	300
011			17	44x114	924
012			17	44x114	300
013			1	44x42	2822
014			1	44x114	2700
015			16	44x114	2700
016			1	44x114	3900
021			18	44x114	3900
026			17	44x114	1444
027			1	44x114	3900
WA-1			1		
WB-1			1		

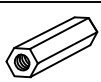
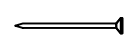
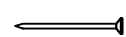
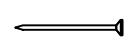
Pos	09.03.2018	Delförteckning - Liste over deler - Stykliste - Osaluettelo Art.Nr. 4416902	9/11	Q	P (mm)	L (mm)
WC-1				1		
IAR2		Grund - Grunnmur - Fundament - Perustus 		10	45x45	5100
IAR1		Grund - Grunnmur - Fundament - Perustus 		2	45x45	3690
A-PR1		Tåkasar - Takbjelke - Tagbjælke - Katto-orret 		3	44x140	5800
		Golvbrädor - Gulvbord - Gulvbrædder - Lattialaudat 		29	90x18	3608
		Golvbrädor - Gulvbord - Gulvbrædder - Lattialaudat 		28	90x18	2408
		Terrassbrädor - Terrassebord - Terrassebrædder - Terrasilauta 		28	90x19	1200
DB		Takbräde - Takbord - Tagbrædder - Kattolauta 		130	90x18	2200
		Golvläkt - Gulvlist - Gulvliste - Jalkalista 			18x18	17.43
RFF		Takläkt - List for takpapp - Tagpapliste - Kattohuopalista 		4	18x58	2250
M12		Gängad stång m10 - Gjengestang m10 - Gevindstang m10 - Kierretanko m10 		3		125
M11		Gängad stång m10 - Gjengestang m10 - Gevindstang m10 - Kierretanko m10 		1		340
M10		Gängad stång m10 - Gjengestang m10 - Gevindstang m10 - Kierretanko m10 		4		2000
PL1		List till terrassräcke - List for terrasserekkerkverk - Lægte til terrassegeländer - Terrassikaiteen lista 		4	18x18	1769
PL2		List till terrassräcke - List for terrasserekkerkverk - Lægte til terrassegeländer - Terrassikaiteen lista 		2	18x70	1769
PL3		List till terrassräcke - List for terrasserekkerkverk - Lægte til terrassegeländer - Terrassikaiteen lista 		42	28x34	994
P2		Stolpe - Søyle - Stolpe - Pilari 		1	70x70	1826
TB-1		Takfotsinklädning - Speilbord - Sternbræt - Ræystäslauta 		4	18x90	2900
DRV-1		Takfot - Forsterkning av takforkant - Tagkantsforstærkning - Ræystäslista 		4	28x34	2900
GM		Vindbräde - Vindski - Vindskede - Kaapelilauta 		4	18x120	2250
LD1		Lock för gängstångshål - Lokk for gjengestanghull - Afdækning for gevindstangsåbning - Kierretangon aukon kansi 		1		
		Skarvmutter for gängstång - Forlængelsesbolt for gjengestang - Forlængelsesmøtrik til gevindstang - Kierretangon pidennysmutteri 		4	D10	

Pos	09.03.2018 Delförteckning - Liste over deler - Stykliste - Osaluettelo Art.Nr. 4416902	10/11	Q	P (mm)	L (mm)
HS104	Skruv för bindbjälke till skjutvägg - Skrue for skyvedørsfeste - Skrue til skydebeslag til væg - Seinän liukukiinnikkeen ruuvi		8	3.5x20	
HS8	Skruv för gavelsegment - Skrue for gavledel - Skrue til gavlsegment - Koristepalan ruuvi		4	3.5x35	
HS9	Skruv för gavelläkt - Skrue for vindski - Skrue til vindskede - Harjalistan ruuvi		24	3.5x50	
HS1	Skruv för täcklist - Skrue for dekkbord - Skrue til dækliste - Kateprofiilin ruuvi		20	3x30	
HS103	Skruv för montering av terrassräcke - Skrue for terrasserekverk - Skrue til terrassegelænder - Terassikaiteen kiinnitysruuvi		4	4.5x80	
HS2	Skruv för täcklist - Skrue for dekkbord - Skrue til dækliste - Kateprofiilin ruuvi		88	4x40	
HS12	Skruv för takfotsinklädning - Skrue for speilbord - Skrue til sternbrædder - Råystäslaudan ruuvi		28	4x40	
HS12	Skruv för förstärkningsreglar till takfot - Skrue for forsterkning av takforkant - Skrue til tagkantsforsterkning - Katon reunan vahvistusruuvi		28	4x40	
HS13	Skruv för stolpe - Skrue for søyle - Skrue til stolpe - Pilarin ruuvi		2	4x60	
HS18	Skruv för takbjälkar - Skrue for takbjelker - Skrue til tagbjelker - Kattopalkin ruuvi		17	5x120	
HS18	Skruv för gaveltriangel - Skrue for gavl - Skrue til gavl - Päätykolmion ruuvi		16	5x120	
HS16	Skruv för 1. väggregel - Skrue for første stokklag - Skrue til første vægbjælke - 1. seinäpalkin ruuvi		10	5x90	
HS16	Skruv för grund - Skrue for grunnmur - Skrue til fundament - Perustuksen ruuvi		32	5x90	
HS72	Skruv för bindbjälke till skjutvägg - Skrue for skyvedørsfeste - Skrue til skydebeslag til væg - Seinän liukukiinnikkeen ruuvi		2	6x40	
HS20	Skruv för höjdjustering av post - Skrue for justering av søylehøyde - Skrue til højdejustering af stolpe - Tolpan korkeudensäätöruuvi		8	6x50	
NF2	Zn spik för golvläkt - Sinkstift for gulvlist - Zn søm til gulvliste - Sinkitty naula jalkalistan asennukseen		35	1.4x40	
SH44	Hammarkloss - Hoggestabbe - Træklods til hamring - Naulauskappale		1		
	Slagmutter för gängstång - Drivmutter for gjengestang - Drivmøtrik til gevindstang - Kierretangon ohjausmutteri		4	D10	
SFS	Mutter för gängstång - Mutter for gjengestang - Møtrik til gevindstang - Kierretangon mutteri		4	D10	
NF3	Förzinkad spik till terrass - Sinkspiker for terrasse - Zn søm til terrasse - Sinkitty terassinäula		168	2.1x50	
NF4	Förzinkad takspik - Sinkspiker for tak - Zn søm til tag - Sinkitty kattonäula		404	2x50	
NF4	Förzinkad golvspik - Sinkspiker for gulv - Zn søm til loft - Sinkitty lattianäula		350	2x50	
NF5	Förzinkad spik för takläkt - Sinkspiker for takpappliste - Zn søm til tagpapliste - Kattohuopalistin sinkitty naula		24	2x40	

Pos	10.11.2017	Delförteckning - Liste over deler - Stykliste - Osaluettelo 560x1780 AK.1.100.TPSP DGP+	1/1	Q	P (mm)	L (mm)
-----	------------	--	-----	---	-----------	-----------

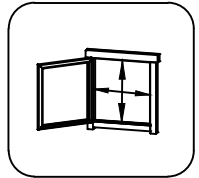
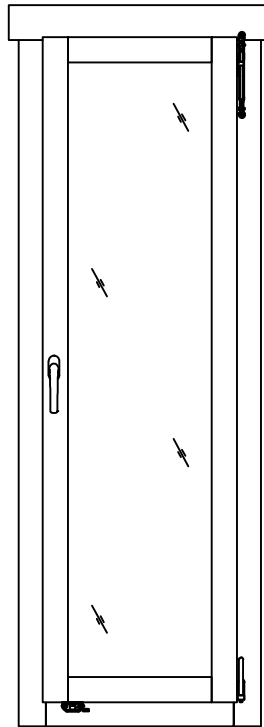

460x1684 mm

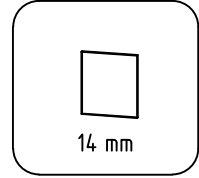

14 mm

390x1602 mm

FS2	Handtagsbeslag för fönster - Vridere til vinduer - Vindueshåndtag - Ikkunanpainikkeet		1		
-----	--	---	---	--	--

Pos

10.11.2017

Delförteckning - Liste over deler - Stykliste - Osaluettelo
1010x1780 TAK.1.100.TPM0.e DGP+

1/1





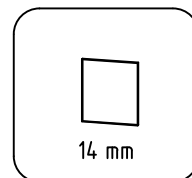
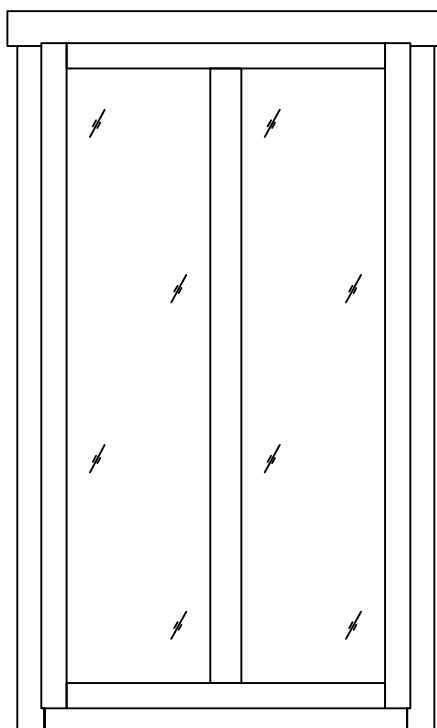

Q

P
(mm)

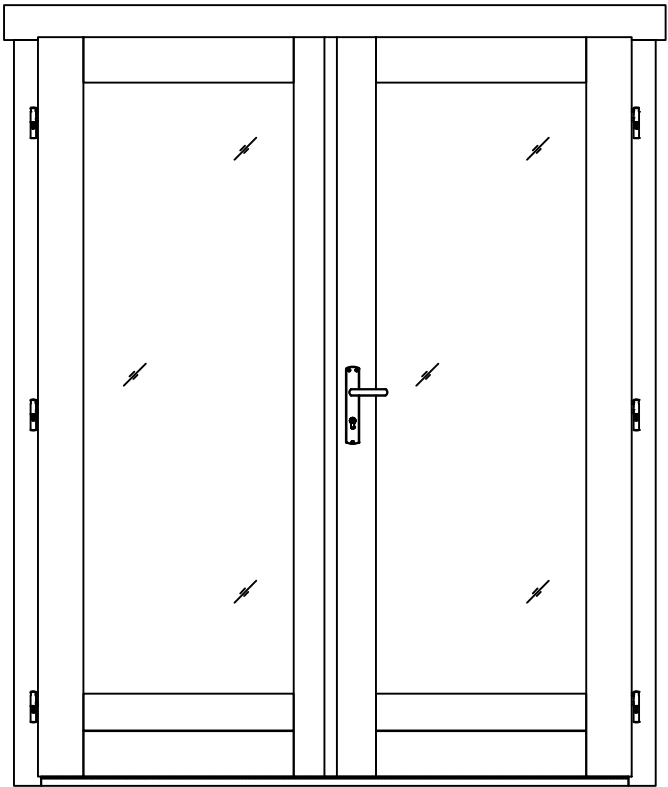
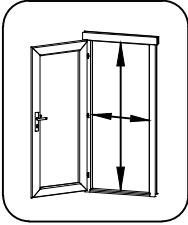
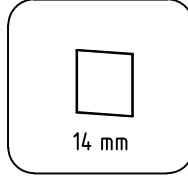
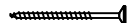
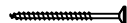
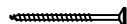
L
(mm)

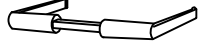

390x1602 mm

Pos	31.10.2017	Delförteckning - Liste over deler - Stykliste - Osaluettelo 1588x1957 TUK.1.100.TPVP.MM DGP+	1/1	Q	P (mm)	L (mm)
						
					 1488x1873 mm	
					 14 mm 561x1593 mm	
HS4	Skruv för golvläkt - Skruer for dørliste - Skruer til dørliste - Ovilistan asennusruuvi		5	3x30		
HS16	Skruv för dörrkarm - Skruer for dørstolpe - Skruer til dørkarm - Oven karmin ruuvi		4	5x90		
HS25	Skruv för dörrträskel - Skruer for terskel - Skruer til dørtrin - Kynnyksen ruuvi		3	4.5x65		
MH	Gångjärn för dörr - Bolt for dørhengsel - Hanskrue til dørhengsel - Oven sarana		6	14x80		
HC	Gångjärnskaopor för dörr - Deksel over hengsle - Hængsel-dæksel - Oven saranasuoja		12			
TL4	Handtag för dörr - Dørbeslag - Dørhåndtag - Ovenpainike		1			
TL5	Sats med täckbrickor för dörrlås - Et sett av dørbeslag - Sæt af låsedæksler - Lukkokilpisarja		1			
	Cylinder - Sylinderrås - Cylinderrås - Sylinterilukko		1	30x35		
	Låsets slutstykke - Fallelåsens sluttstykke - Låsens slutstykke - Ovensalvan vastakappale		2			