

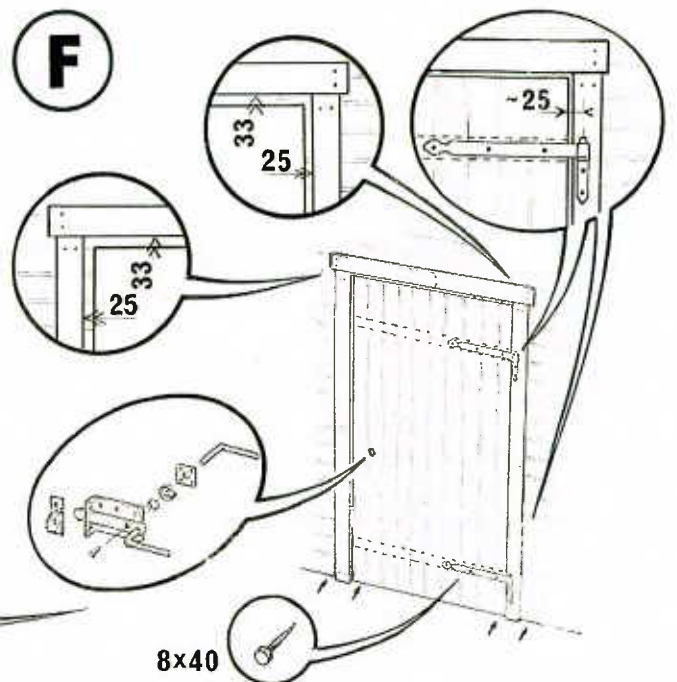

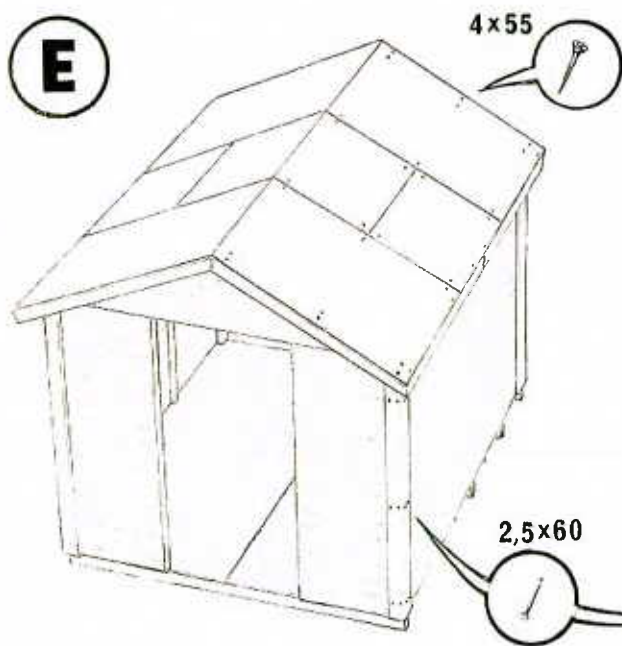

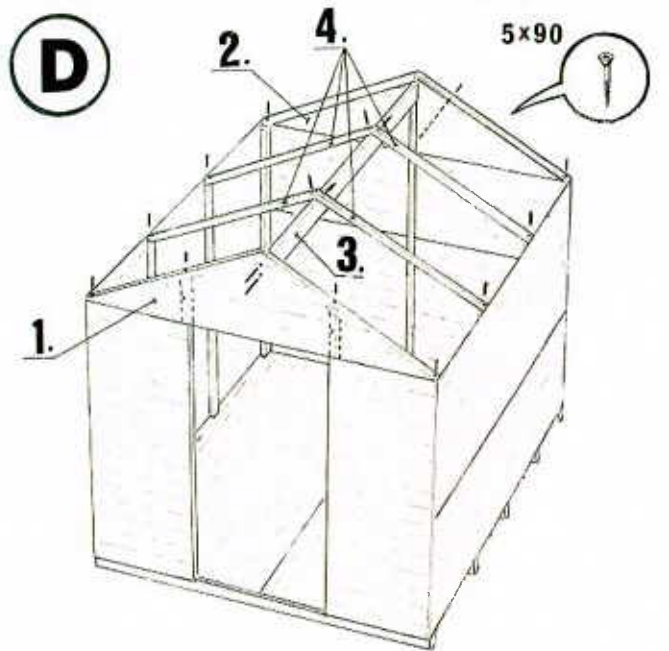

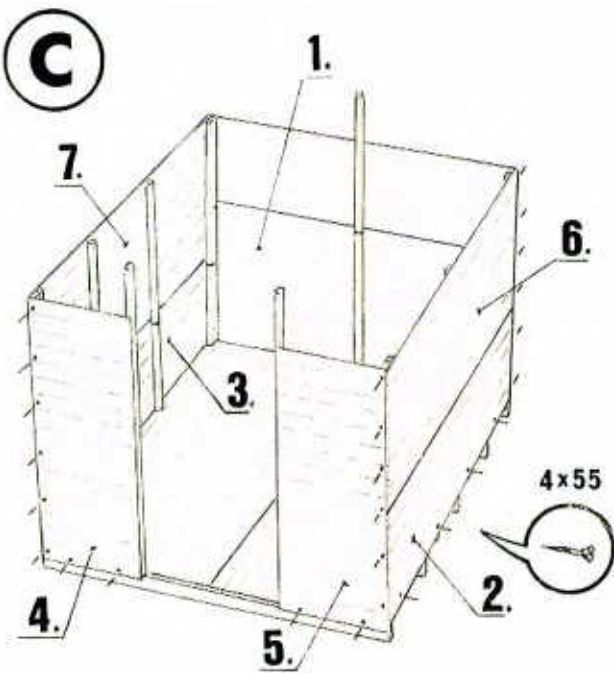

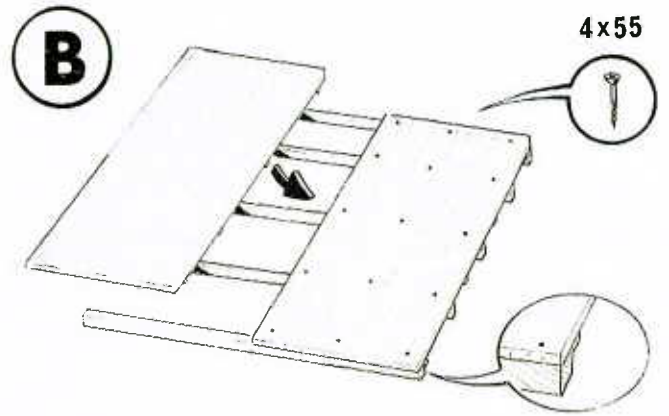
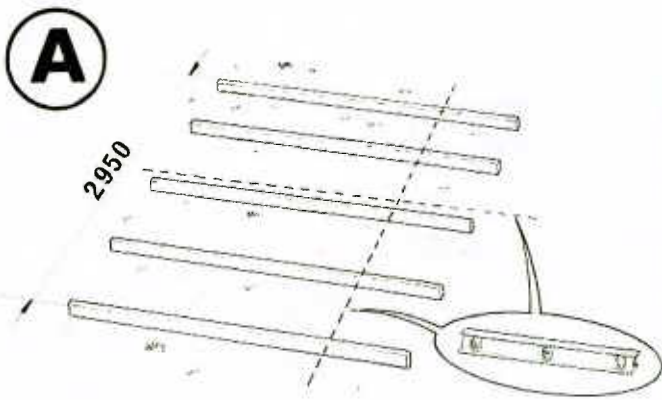





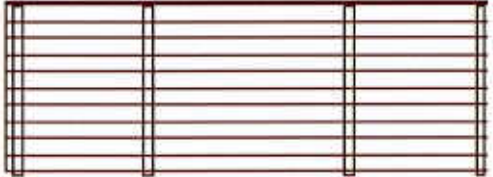
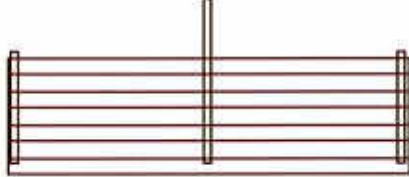











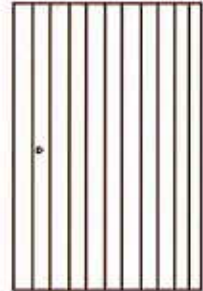

VARASTON OHJE

1. Asenna pohjapuut (nro 1) paikoilleen (katso kuva A)
2. Asenna pohjaelementit (nro 2) paikoilleen 15 kpl 4x55 ruuvilla per elementti (katso kuva B)
3. Asenna seinäelementit (nrot 4, 5, 6, 7, 8) yhteen kolmella 4x55 ruuvilla molemmista päistä sekä pohjaan neljällä 4x55 ruuvilla joka reunalta (katso kuva C)
4. Asenna oven päälle päätykolmio (nro 9) kuudella 5x90 ruu (katso kuva D)
5. Asenna toisen päädyn yläkolmio (nro 10) paikalleen kahdella 5x90 ruuvilla (katso kuva D)
6. Asenna orsipuu (nro 11) paikalleen kahdella 5x90 ruuvilla molemmista päistä (katso kuva D)
7. Asenna katon runkokuut (nro 12) yhdellä 5x90 ruuvilla molemmista päistä (katso kuva D)
8. Asenna kattovanerit (nrot 13 ja 14) paikoilleen, isot palat (nro 13) kuudella ja pienet (nro 14) neljällä 4x55 ruuvilla (katso kuva E)
9. Asenna otsalaudat (nrot 15 ja 16) paikoilleen kolmella 4x55 ruuvilla per puu (katso kuva E)
10. Asenna nurkkalaudat (nrot 17 ja 18) paikoilleen 2.5x60 nauloilla, 12 kpl per nurkka (katso kuva E)
11. Asenna ovenreunuslaudat (nrot 19 ja 20) paikoilleen kuudella 2.5x60 naulalla per lauta (katso kuva F)
12. Asenna saranat (nro 22) paikoilleen oveen 8x40 täkkipulteilla (katso kuva F)
13. Asenna säppisalpa paikalleen kuudella 5x20 ruuvilla ja vastakappale kahdella 5x35 ruuvilla (katso kuva F, säppisalvan asennusohje erikseen)

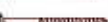

NR			koko	kpl
1		pohjapuu	45x95x2395	5
2		pohjaelementti	1200x2950	2
3		päätyelementti	1150x2395	1
4		sivuelementti	800x2950	2
5		päätyelementti, oikea	650x1900	1
6		päätyelementti, vasen	650x1900	1
7		sivuelementti	1150x2950	1
8		päätyelementti	750x2395	1
9		päätykolmio	30/600x2400	1
10		päätykolmio	30/600x2400	1
11	 	orsipuu	45x145x2950	1

12		kattorunko	45x95x1280	4
13		kattovaneri	1620x1200	4
14		kattovaneri	810x1200	4
15		päätyräystäslauta	30x100x1620	4
16		sivuotsalauta	30x100x1800	4
17		nurkkalauta	20x100x1940	4
18		nurkkalauta	20x120x1985	4
19		oven reunuslauta	20x120x1930	2
20		oven reunuslauta	20x120x1450	1
21		ovi	1100x1950	1
22		sarana		2
23		salpa		1
24		täkkipultti	8x50	10
25		ruuvi	5x90	18
26		ruuvi	4x55	134
27		naula	2.5x60	70
28		ruuvi	5x20	6
29		ruuvi	5x35	2