

C-C

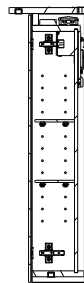

A-A

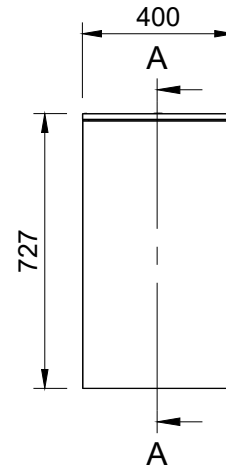

A

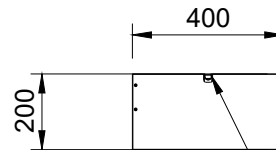

Sähkökaapeli sisääntulo
 Intaget för elkabeln
 Electrical cable entry

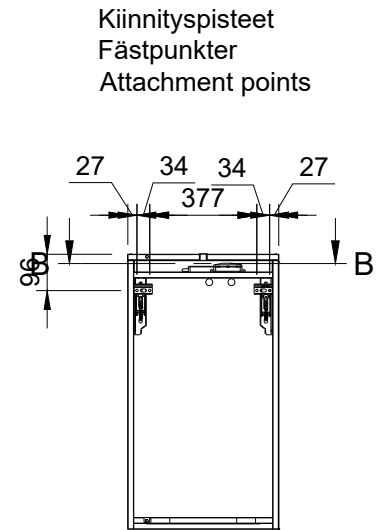

Kiinnityspisteet
 Fästpunkter
 Attachment points

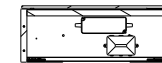

B-B

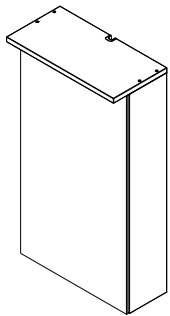

 Huoltamotie 3 29250 Nakkila www.temal.fi	Created by	Date	
	TR	17.4.2026	
	Title	Project	
	PKA40	2026	
	Description	Product line	
	UNIC PEILIKAAPPI 40	----	
Mass	Revision	Scale	Sheet
11.5 kg		1:20	1/1