

B-B

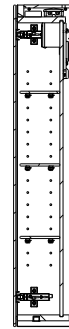

A-A

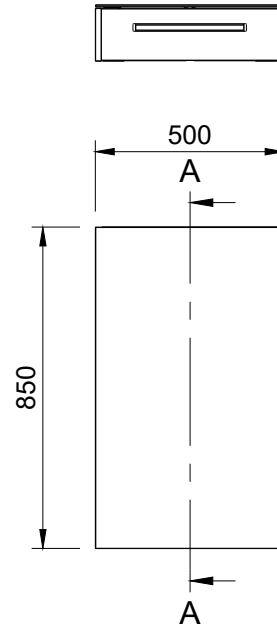

A

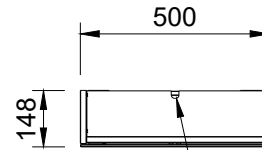

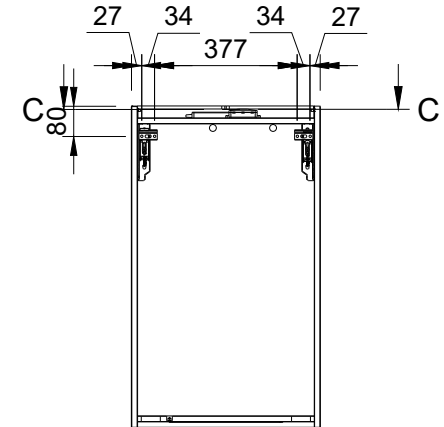

Sähkökaapeli sisääntulo
Intaget för elkabeln
Electrical cable entry

Kiinnityspisteet
Fästpunkter
Attachment points

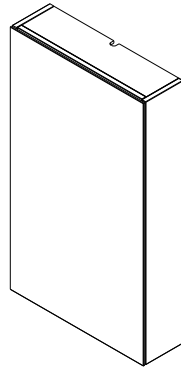
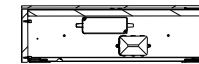

C-C



 Huoltamotie 3 29250 Nakkila www.temal.fi	Created by	Date	
	TR	20.4.2026	
	Title	Project	
	PKB50	2026	
	Description	Product line	
	EMINA PEILIKAAPPI 50	----	
Mass	Revision	Scale	Sheet
15.288 kg		1:20	1/1