

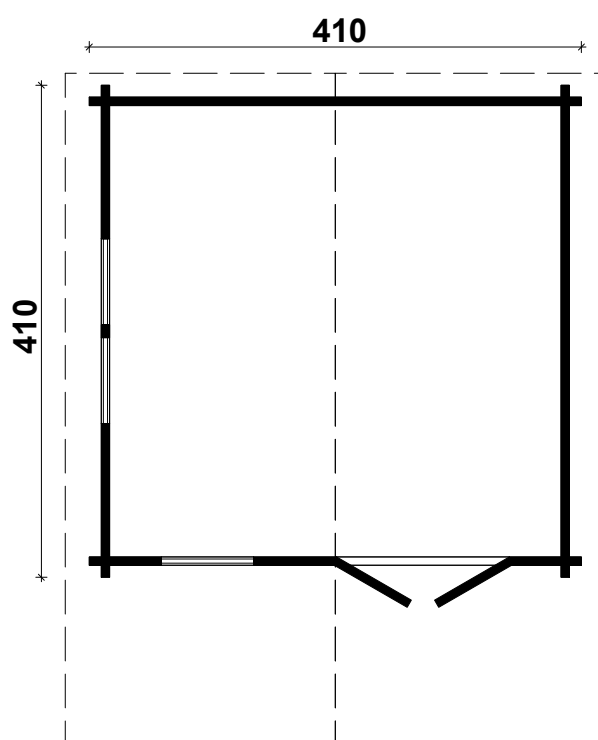

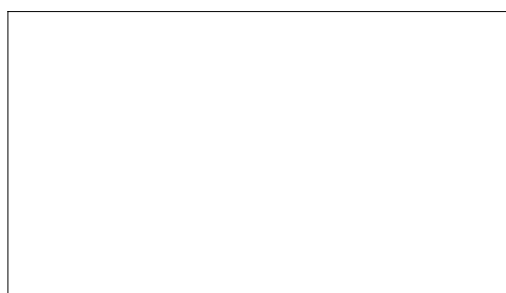

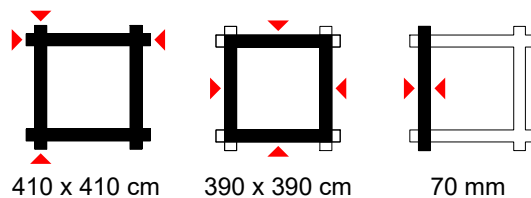





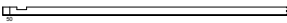



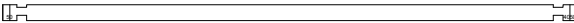

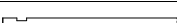

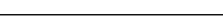
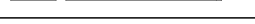

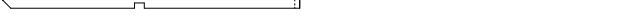

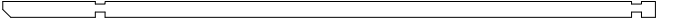
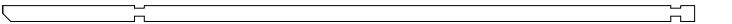
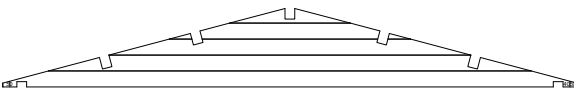

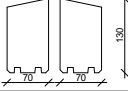
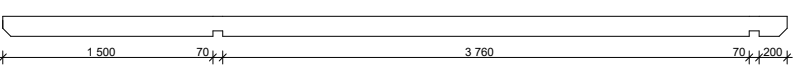
# Göteborg A 70

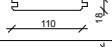
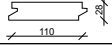
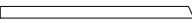
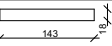
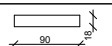
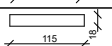

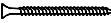

DE Alle angegebenen Maße sind ca.-Maße  
EN All dimensions are approximate  
NL Alle maten zijn circa maten  
NO Alle vedlagte mål er ca  
ES Todas las dimensiones son aproximadas  
PT Todas as dimensões são aproximadas  
PL Wszystkie wymiary są przybliżone  
EE Kõik mõõdud on ligilähedased  
IT Tutte le misure indicate sono circa  
DK Alle angivne mål er ca.-mål  
SE Samtliga mått är ungefärliga  
FR Toutes les dimensions fournies sont approximatives

# Teileliste Göteborg A 70 mm - 410 x 410 cm

Nr.	Beschreibung	Profil mm	Länge mm	Stück	
001	Fundamenthölzer		3870	2	
002			3730	8	
003			2060	1	
004			600	1	
005			4100	1	
006			4100	19	
007			4100	22	
008			2060	8	
009			1280	15	
010			600	26	
011			690	9	
012			1560	1	
013			1840	1	
014			2120	1	
015			4380	1	
016			4660	1	
017			4940	1	
018			5220	2	
019			--	--	
020				4100	2
021				5600	2(1+1)
022				5600	5(4+1)
023	Dachpappe			--	--
024	Dachbretter		2320	102+2	
025	Fußbodenbretter		3757	35+1	
026	Giebelblende 		2370	4	
027	Giebelabschlussbrett		2370	4	
028	Traufenbrett		5600	2	
029	Traufenleiste		5600	2	
030	Raute			2	
031	Fußleisten		ca. 15,1m		
032	Gewindestange		2200	4	
033	Schrauben 4,0x40; 4,0x50; 5,0x70; 6,0x140 		50 / 800 / 20 / 60		
034	Nägel 1,4x35			50	
036	Mutter, Scheibe 			8	

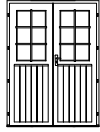
# Teileliste Göteborg A 70 mm - 410 x 410 cm

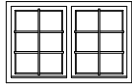
Nr.	Beschreibung	Profil mm	Länge mm	Stück
037	Schlaghölzer	70 x 114	300-400	
038	Doppeltür 1425 x 1955 mm ISO / 70 mm - R			1
039	Einzelfenster 765 x 990 mm ISO / 70 mm			1
040	Doppelfenster 1530 x 990 mm ISO / 70 mm			1

# Göteborg A 70 mm - 410 x 410 cm

## Fundamentplan

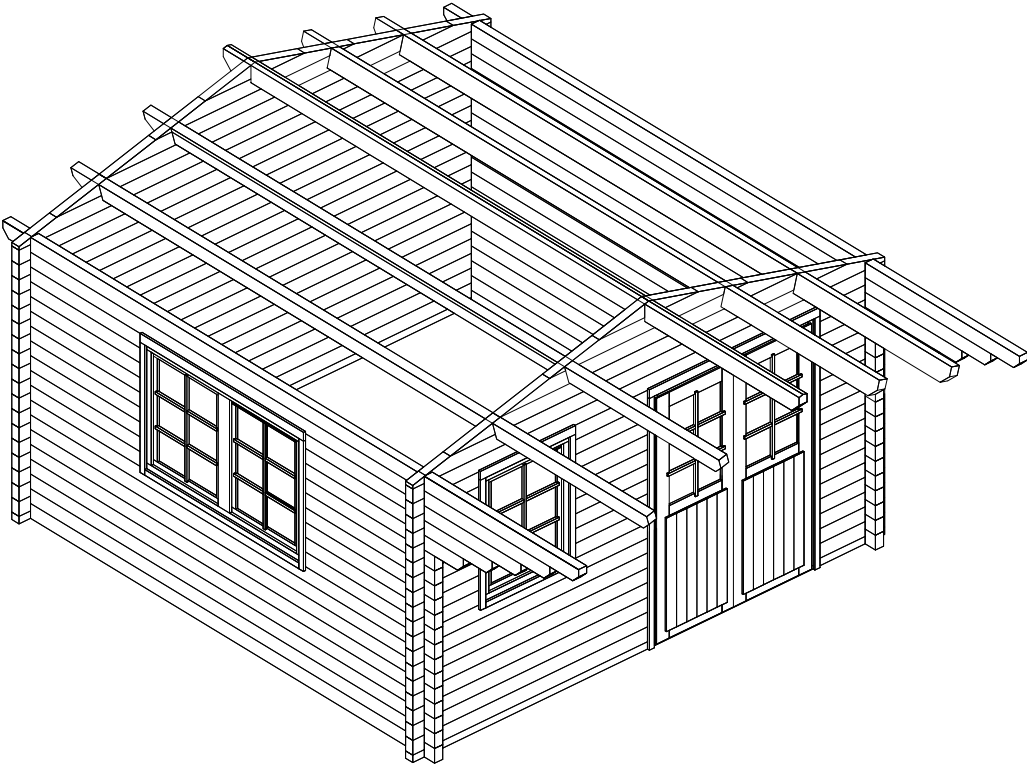
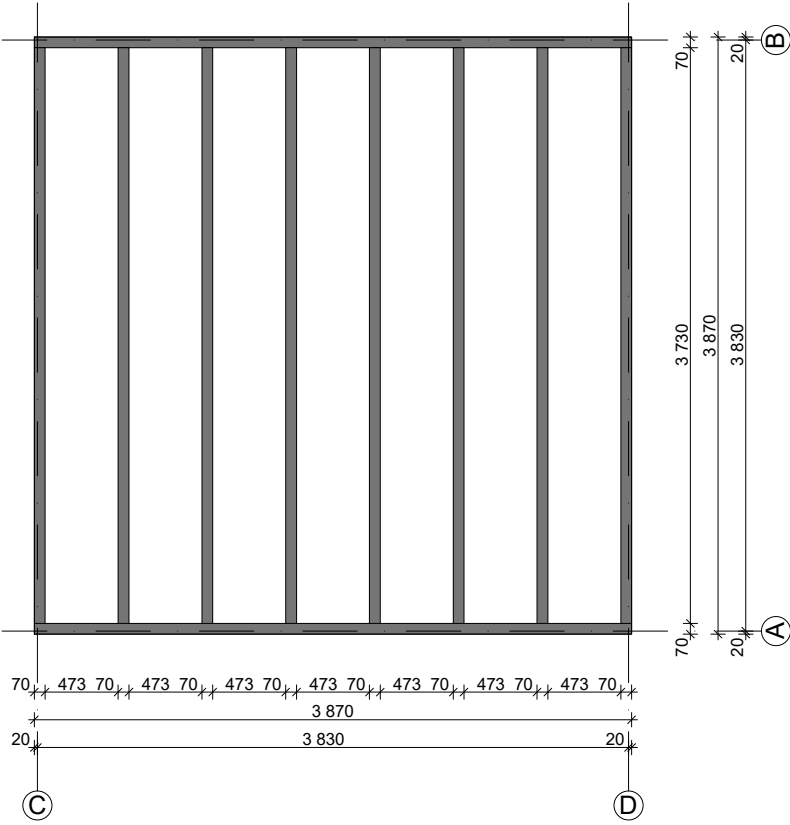

# Göteborg A 70 mm - 410 x 410 cm

## Wandplan

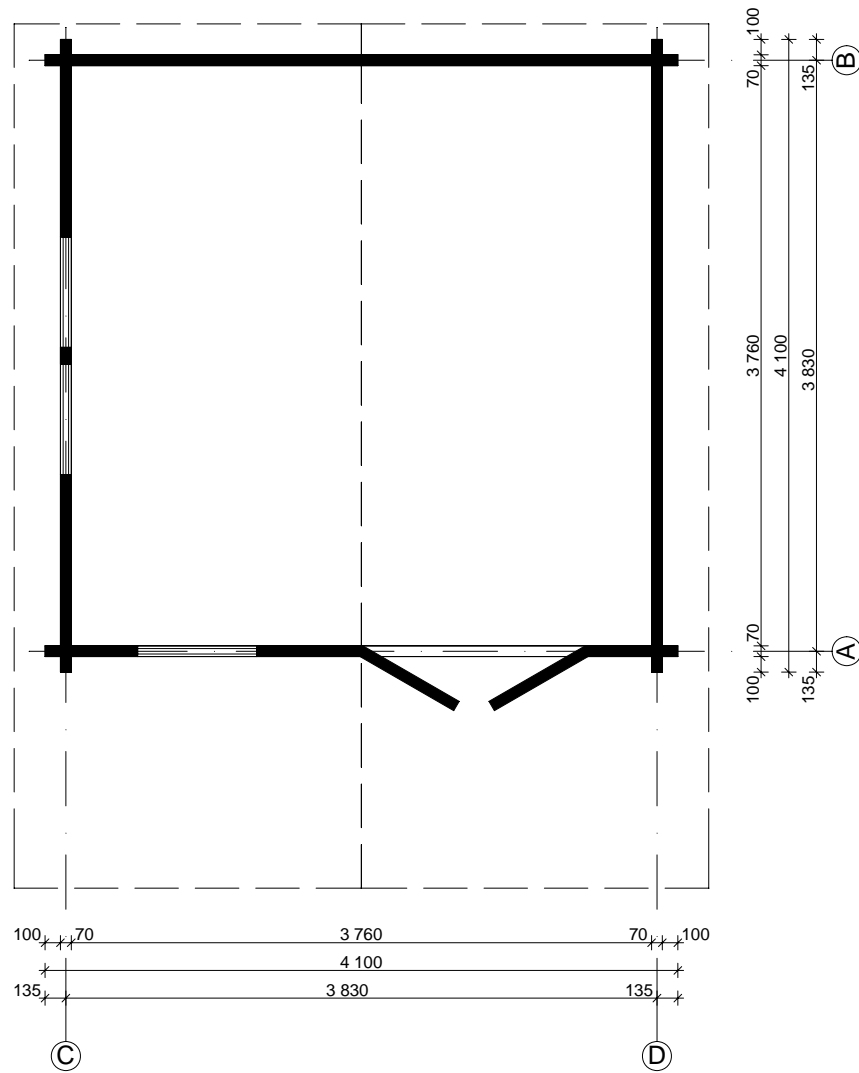

# Wandplan Göteborg A 70 mm - 410 x 410 cm

## Wand A

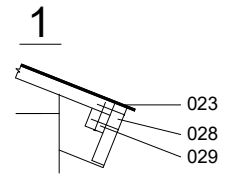
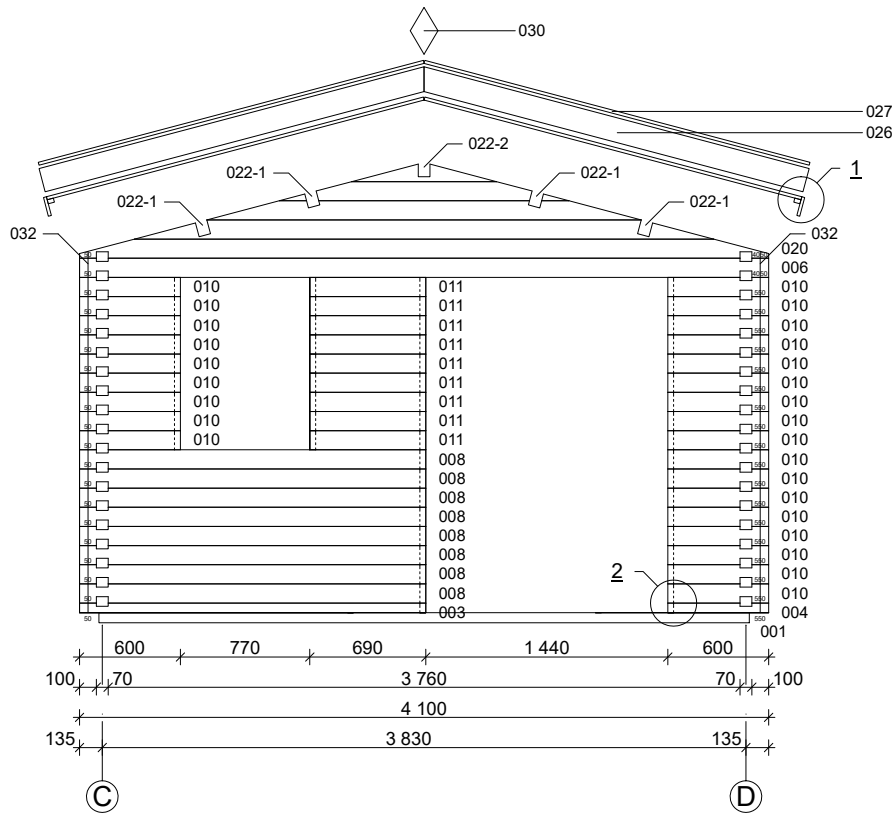

2

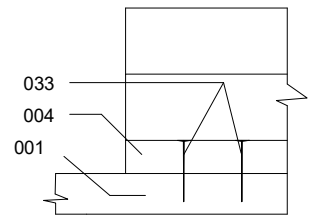

A-A

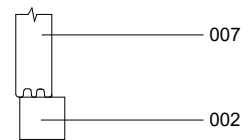

B-B

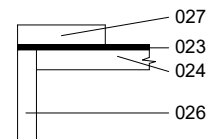

## Wand B

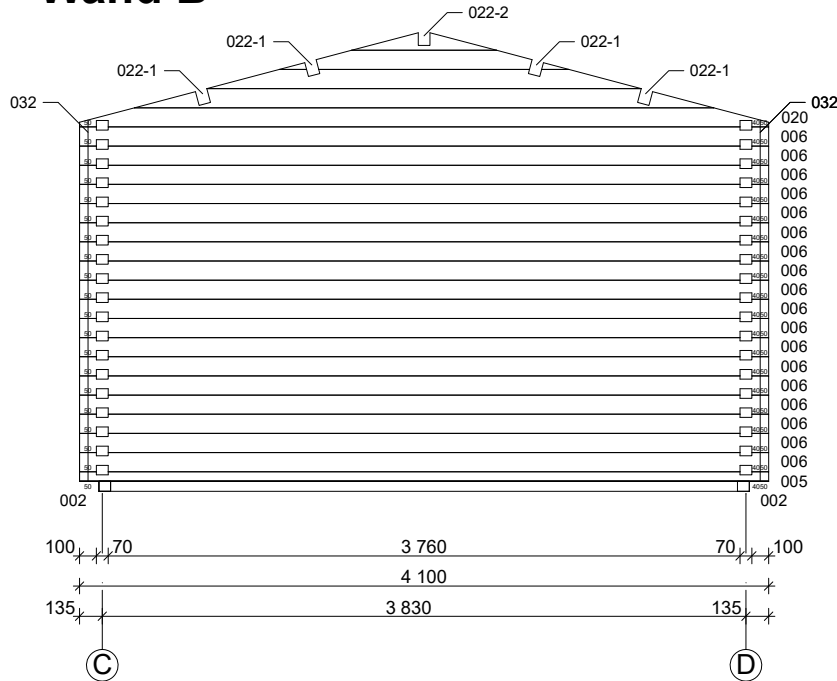



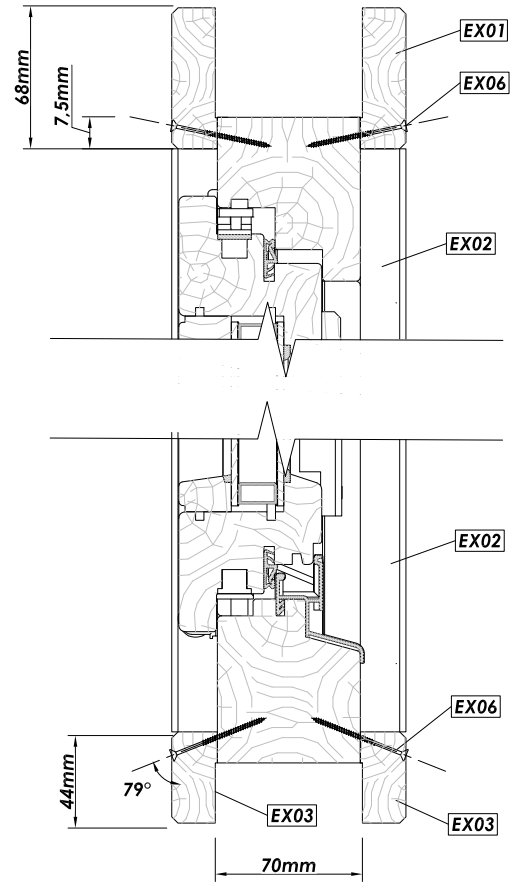
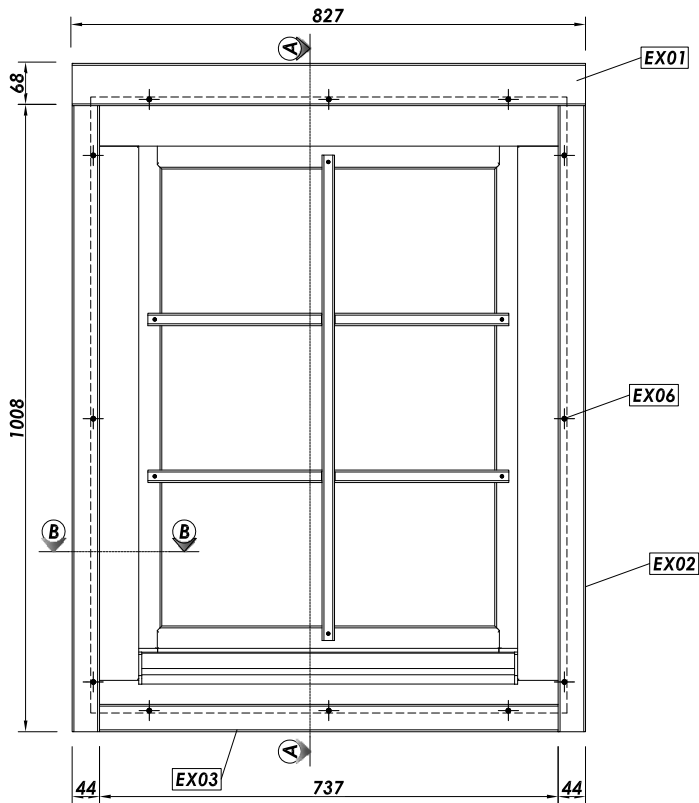

# A - A

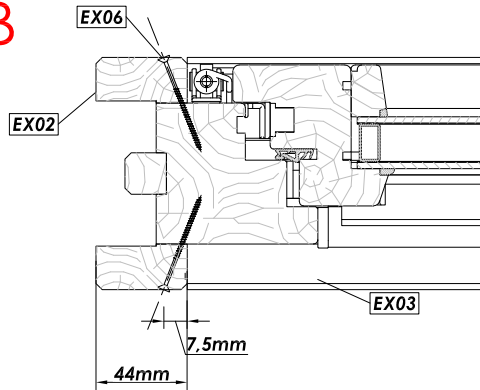

# B - B

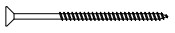

Premium Window 70mm / 765 x 990				
Nr.	Description	Profile mm	Length mm	Quantity
EX01	Exterior- and interior trim	 22x68	827	2
EX02	Exterior- and interior trim	 22x44	1008	4
EX03			737	2
EX04			--	--
EX05			--	--
EX06	Screws 3,5 x 50			

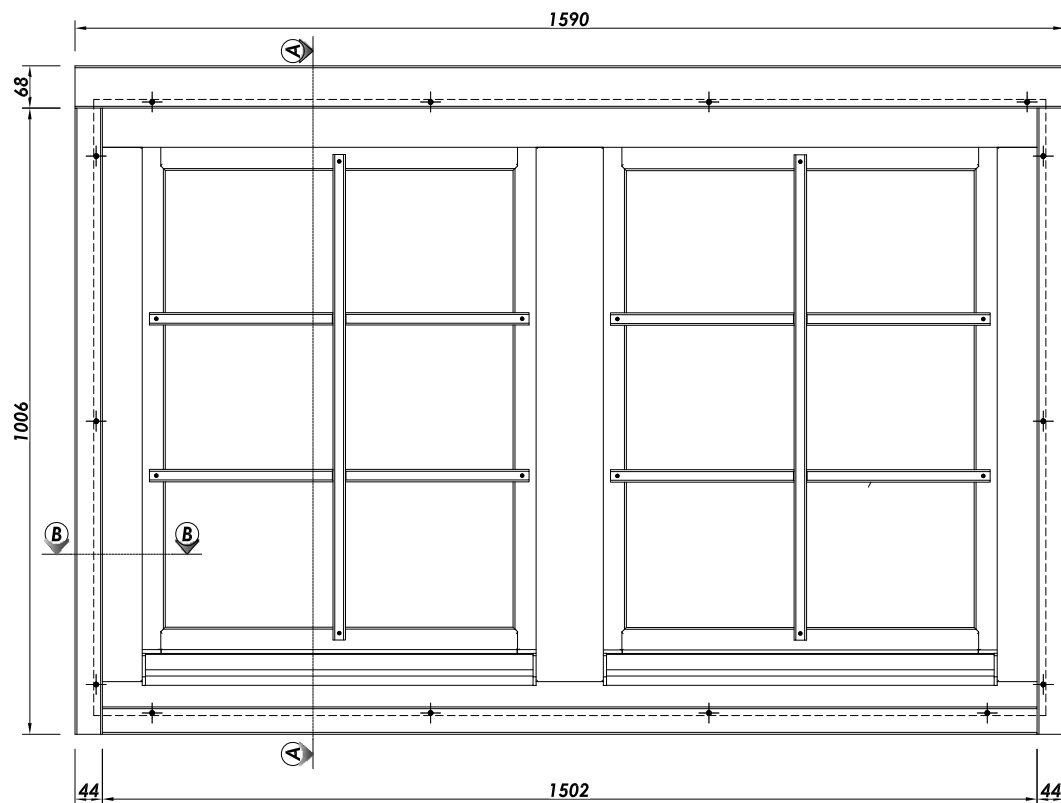

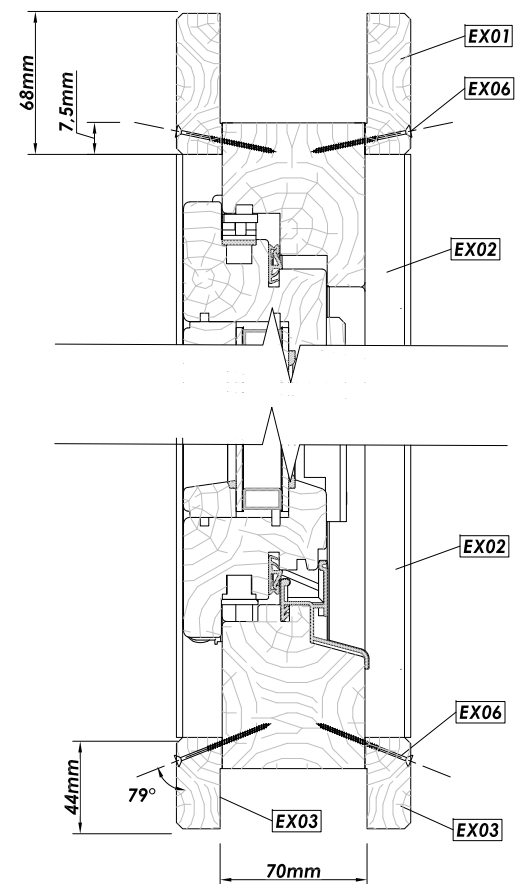

A - A

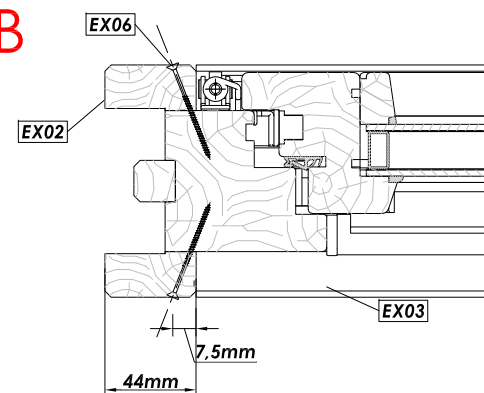

B - B



Premium Window 70mm / 1530 x 990

Nr.	Description	Profile mm	Length mm	Quantity
EX01	Exterior- and interior trim	 22x68	1590	2
EX02	Exterior- and interior trim	 22x44	1006	4
EX03			1502	2
EX04			--	--
EX05			--	--
EX06	Screws 3,5 x 50			

# Double Door Frame 58/70mm

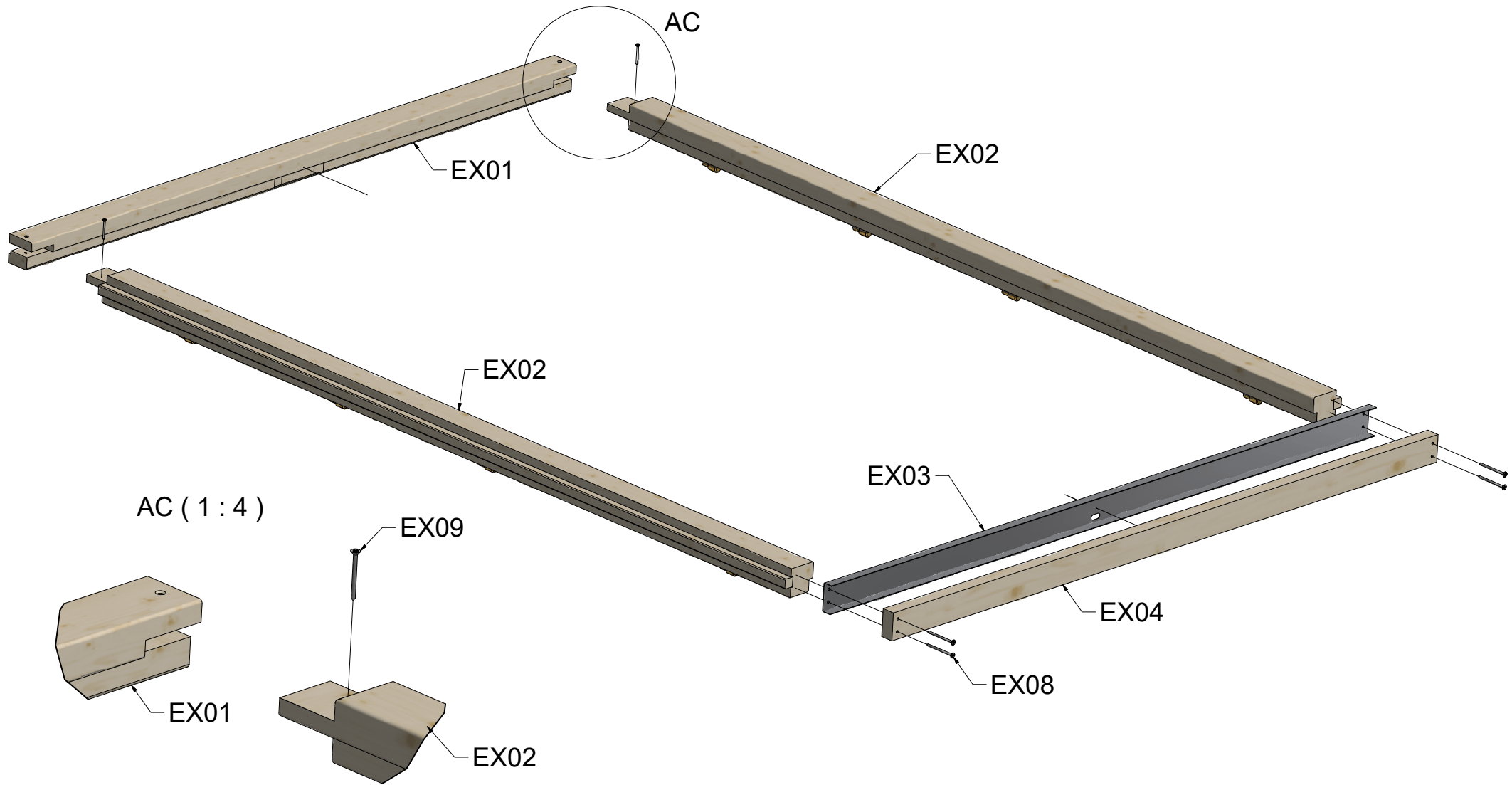

# Double Door Frame 58/70mm

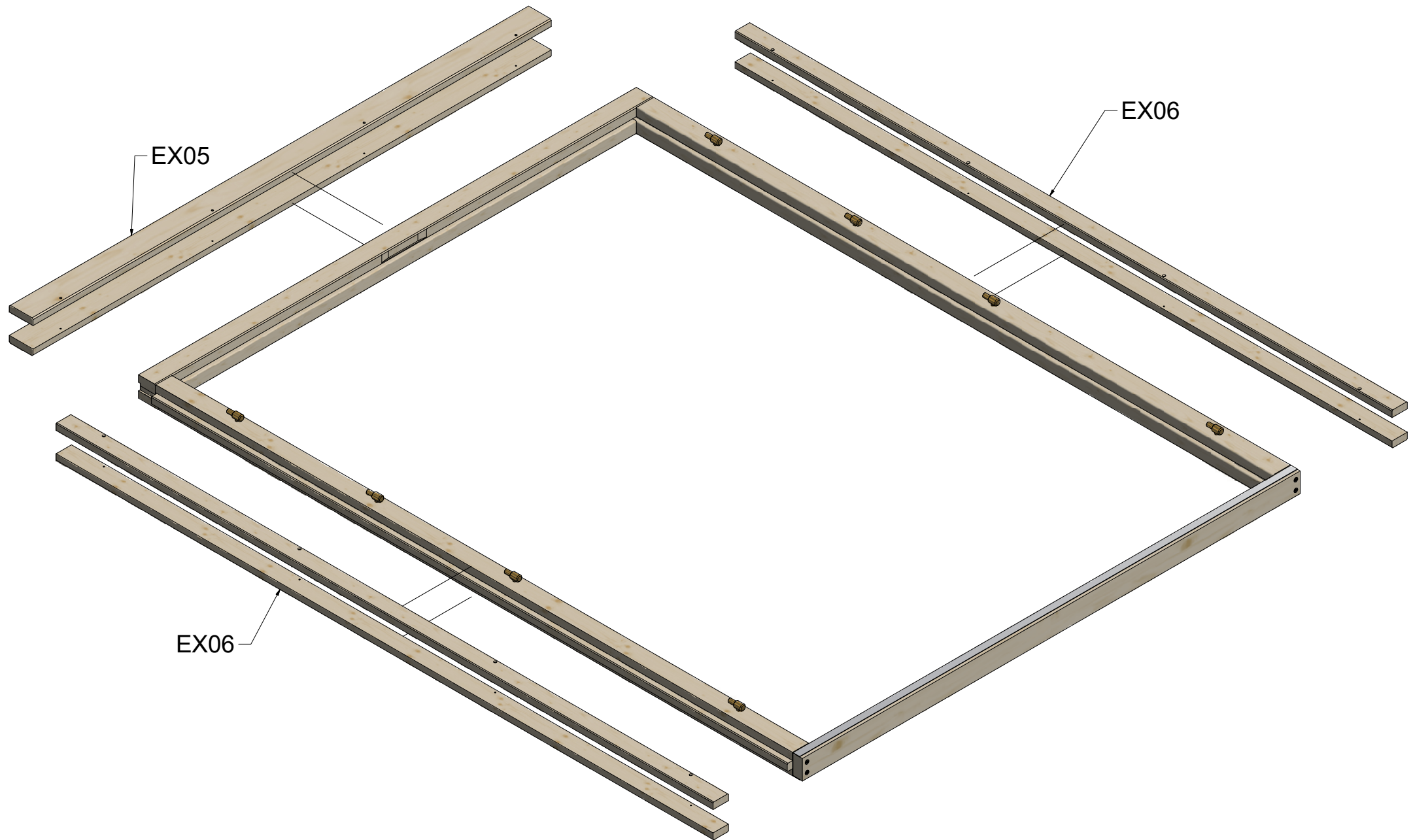

# Double Door Frame 58/70mm

AA ( 1 : 2 )

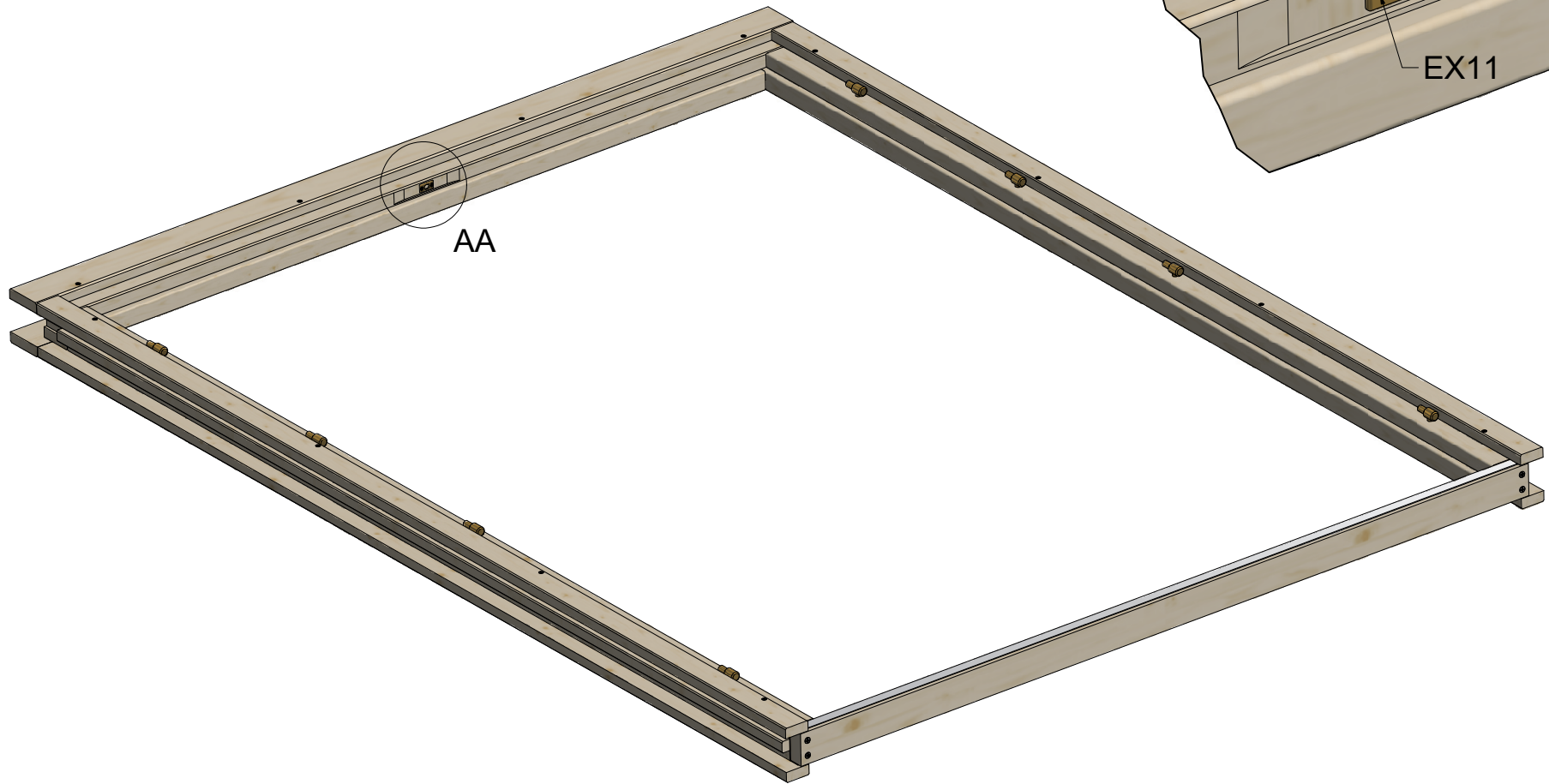
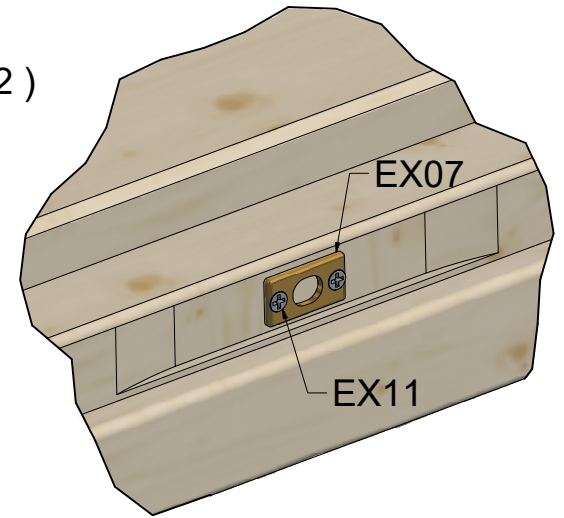

VIEW43 ( 1 : 20 )

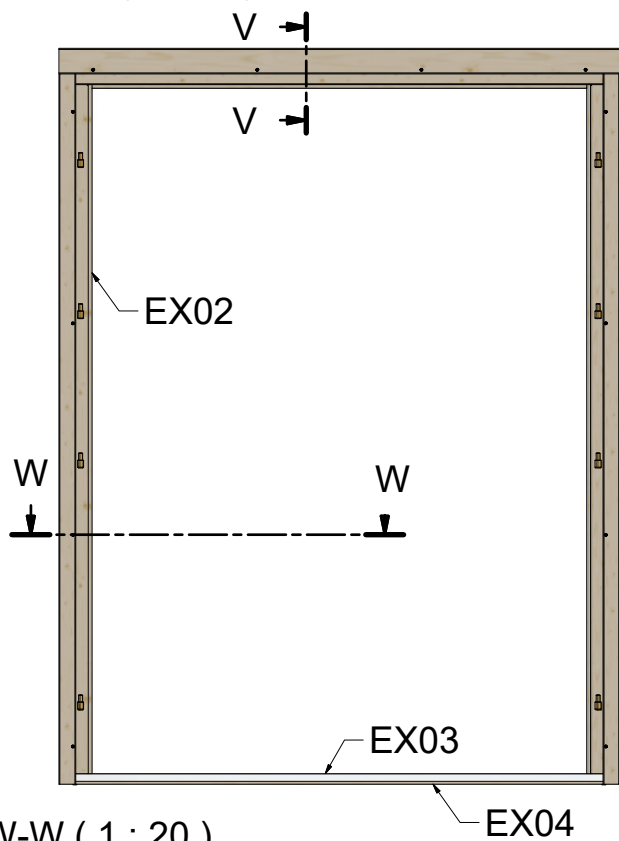

V-V ( 1 : 4 )

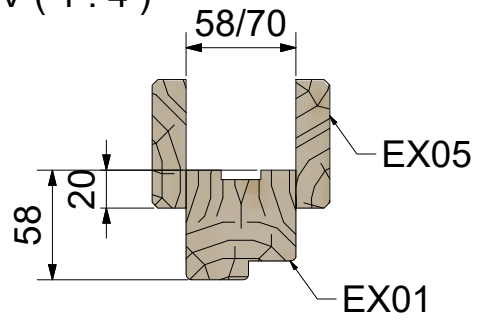







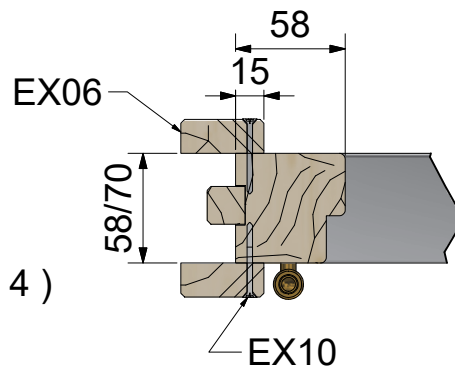









W-W ( 1 : 20 )



Y ( 1 : 4 )

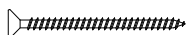

Specification Double Door Frame 58/70mm

Nr	Description	Profile	Amount
EX01		 58 X 58/70	1
EX02		 58 X 58/70	1+1
EX03		 15 X 58/70	1
EX04		 28 X 58/70	1
EX05		 18 X 68	2
EX06		 18 X 44	4
EX07			1
EX08	Screws 5,0 x 70 		4
EX09	Screws 4,0 x 50 		2
EX10	Screws 4,0 x 40 		24
EX11	Screws 3,0 x 30 		2