

Göteborg B 70

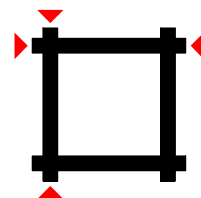

500 x 410 cm

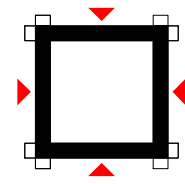

480 x 390 cm

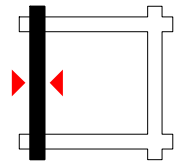



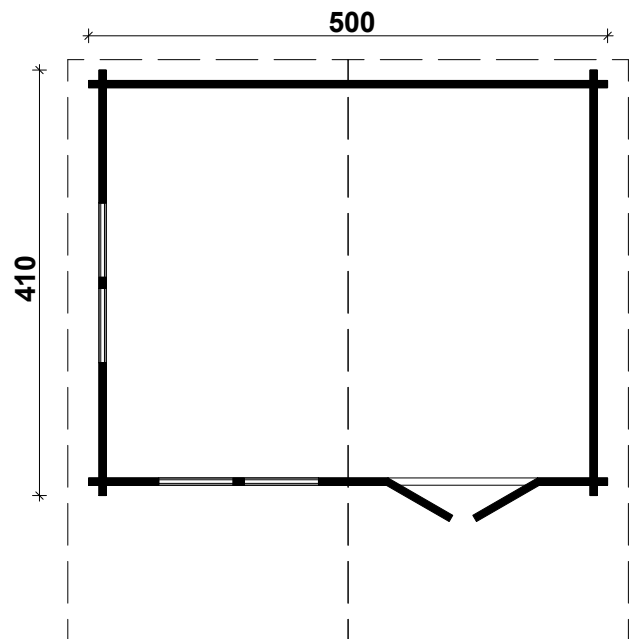







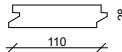
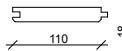

70 mm

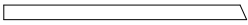
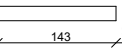
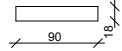
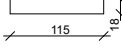



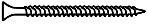

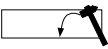
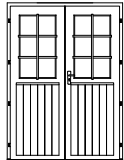
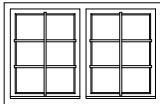







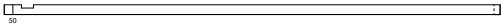

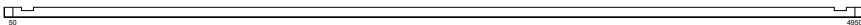

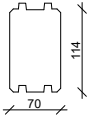



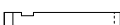

DE Alle angegebenen Maße sind ca.-Maße
EN All dimensions are approximate
NL Alle maten zijn circa maten
NO Alle vedlagte mål er ca
ES Todas las dimensiones son aproximadas
PT Todas as dimensões são aproximadas
PL Wszystkie wymiary są przybliżone
EE Kõik mõõdud on ligilähedased
IT Tutte le misure indicate sono circa
DK Alle angivne mål er ca.-mål
SE Samtliga mått är ungefärliga
FR Toutes les dimensions fournies sont approximatives

Göteborg B 70 mm / 500 x 410 cm - EX

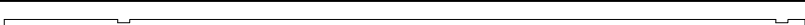
Nr.		 mm	 mm	 x
EX01	Foundation beams / Fundamenthölzer		4770	2
EX02			3730	9
EX03	Floorboard / Fußbodenbretter		4657	35+1
EX04	Roofboard / Dachbretter		2790	102+2
EX05	Roofing felt / Dachpappe		--	--
EX06	Fascia board / Giebelblende 		2840	4
EX07	Gable edge board / Giebelabschlussbrett		2840	4
EX08	Eave edging / Traufenbrett		5600	2
EX09	Eave edging slat / Traufenleiste		5600	2
EX10	Diamond / Raute			2
EX11	Baseboard / Fußleisten		ca. 16,9 m	
EX12	Threaded rod / Gewindestange		2200	4
EX13	Nut, Washer / Mutter, Scheibe 	M10		8
EX14	Screws / Schrauben 4,0x40 / 4,0x50 / 5,0x70 / 6,0x140 		50 / 900 / 50 / 60	
EX15	Nails / Nägel 1,4x35 		50	
EX17	Hitblock / Schlaghölzer 	70 x 114	300-400	3
EX18	Double door / Doppeltür 1425 x 1955 mm ISO / 70 mm - R			1
EX19	Double window / Doppelfenster 1530 x 990 mm ISO / 70 mm			2

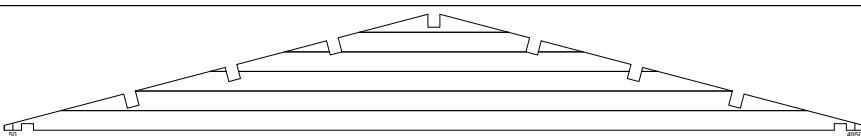
Göteborg B 70 mm / 500 x 410 cm - Specification / Teileliste

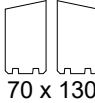
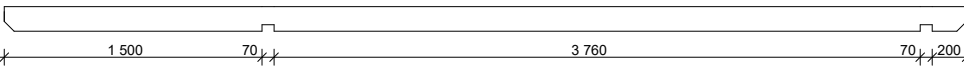
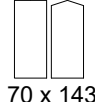
Nr.		 mm	 mm	 x	
003			2885	1	
004			675	1	
005			5000	1	
006			5000	19	
007			4100	22	
008			2885	8	
009			1280	15	
010			675	26	
011			670	9	
012			1560	1	
013			1840	1	
014			2120	1	
015			4380	1	
016			4660	1	
017			4940	1	
018			5220	2	
020			5000	2	
021				5600	2(1+1)
022				5600	7(6+1)

Göteborg B 70 mm / 500 x 410 cm

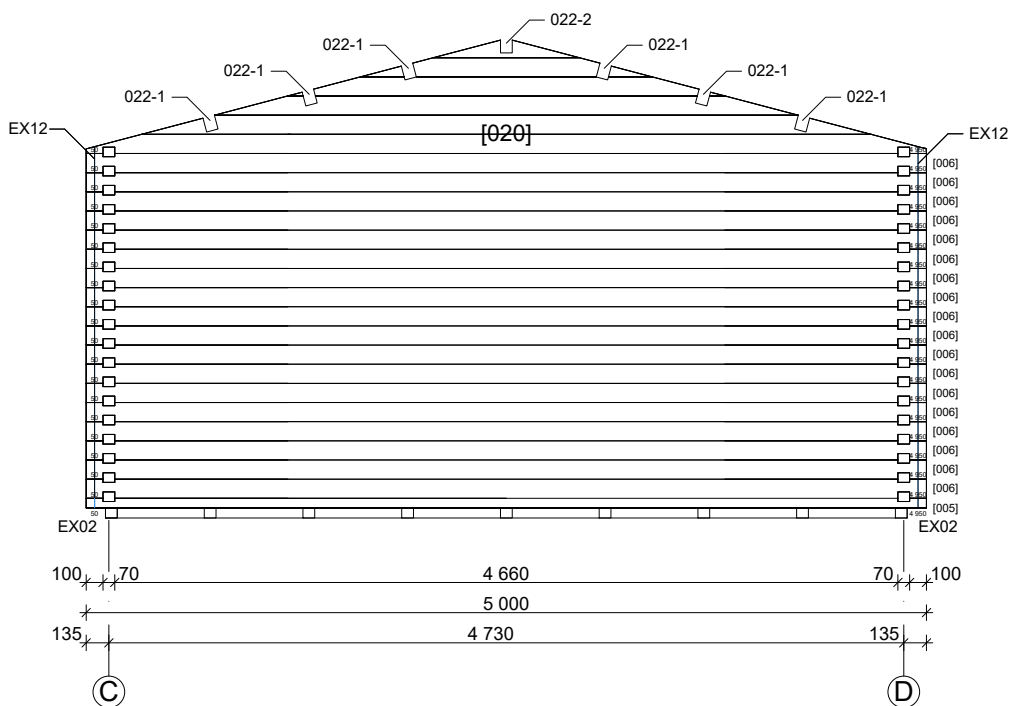
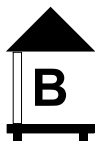
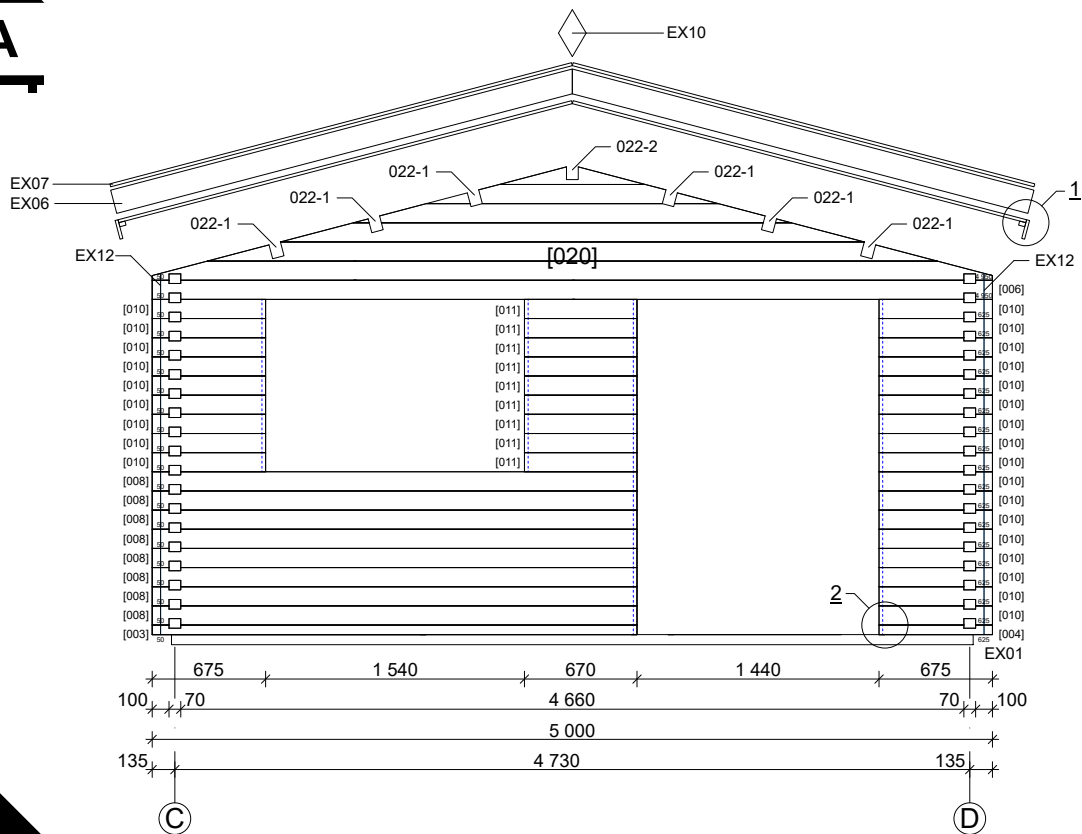

1

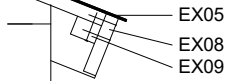

2

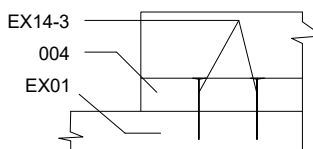

100 100

Göteborg B 70 mm / 500 x 410 cm

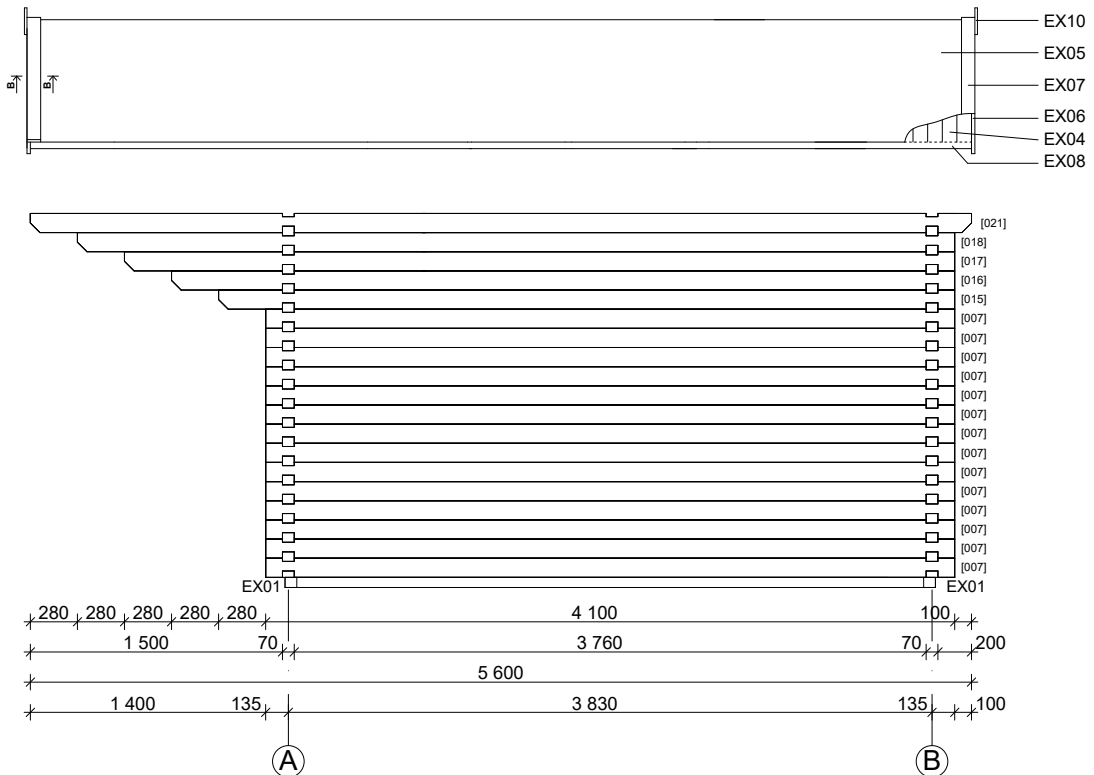
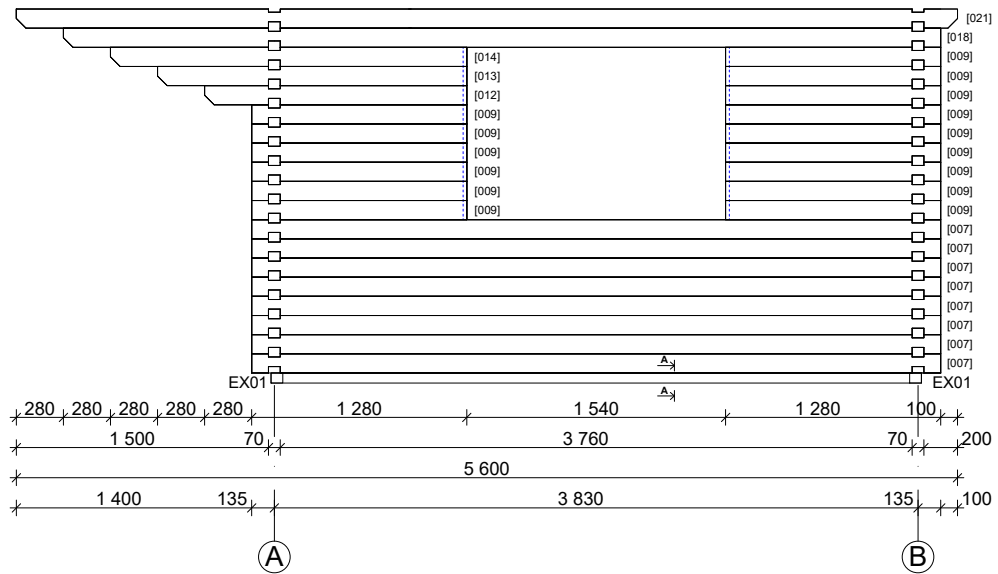
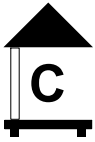

A-A

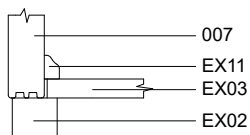

B-B

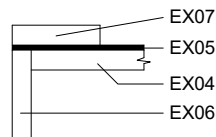

Double Door Frame 58/70mm

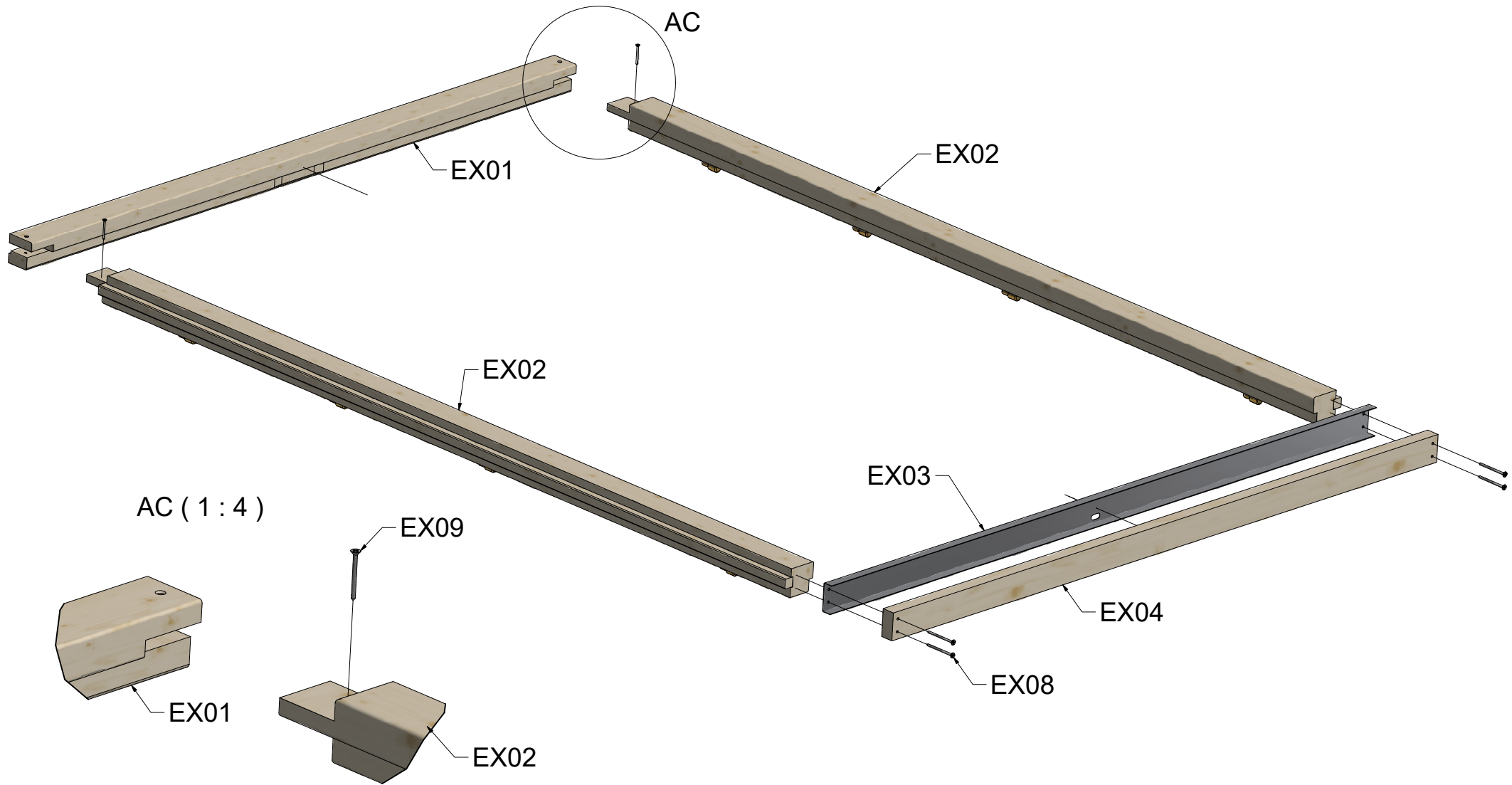

Double Door Frame 58/70mm

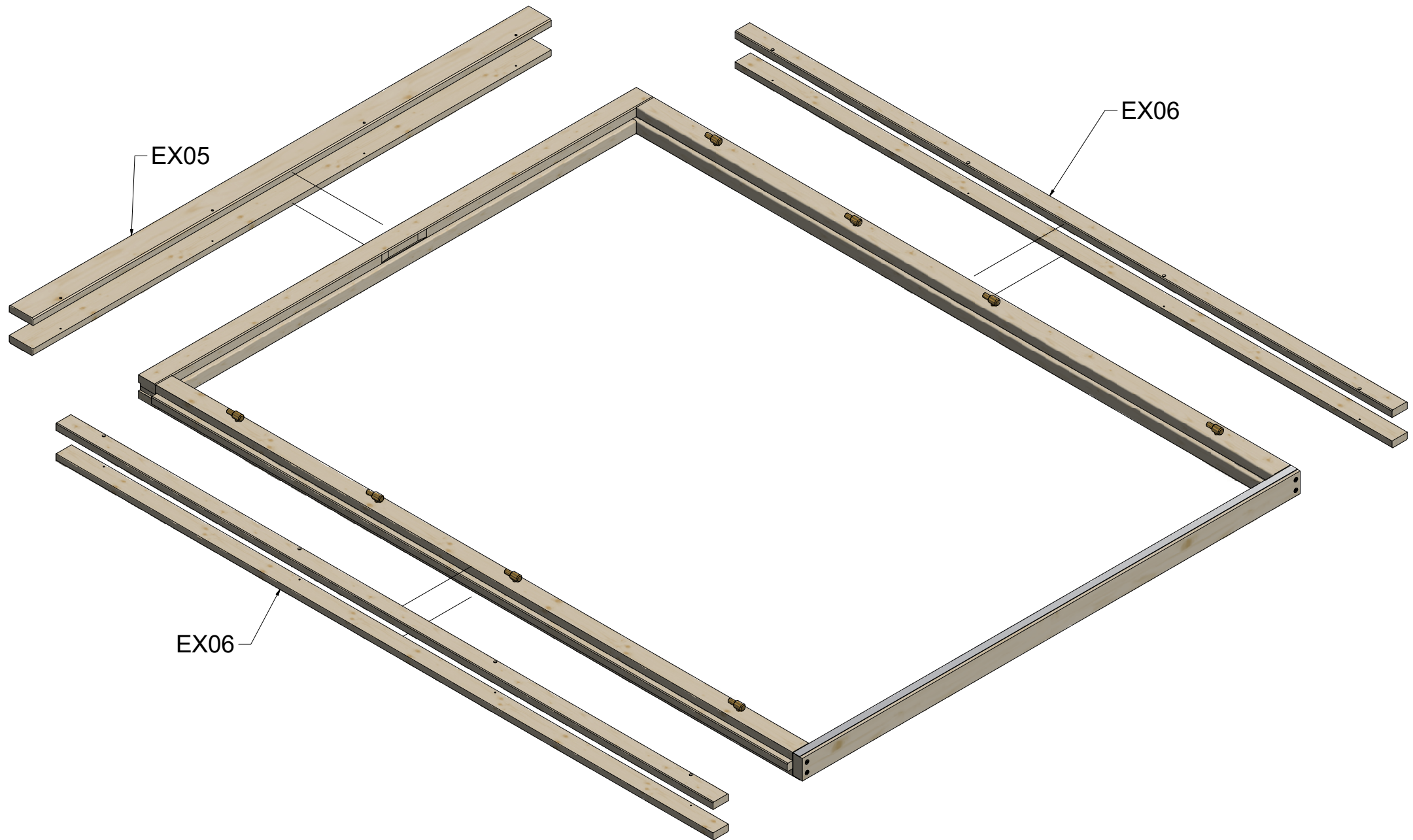

Double Door Frame 58/70mm

AA (1 : 2)

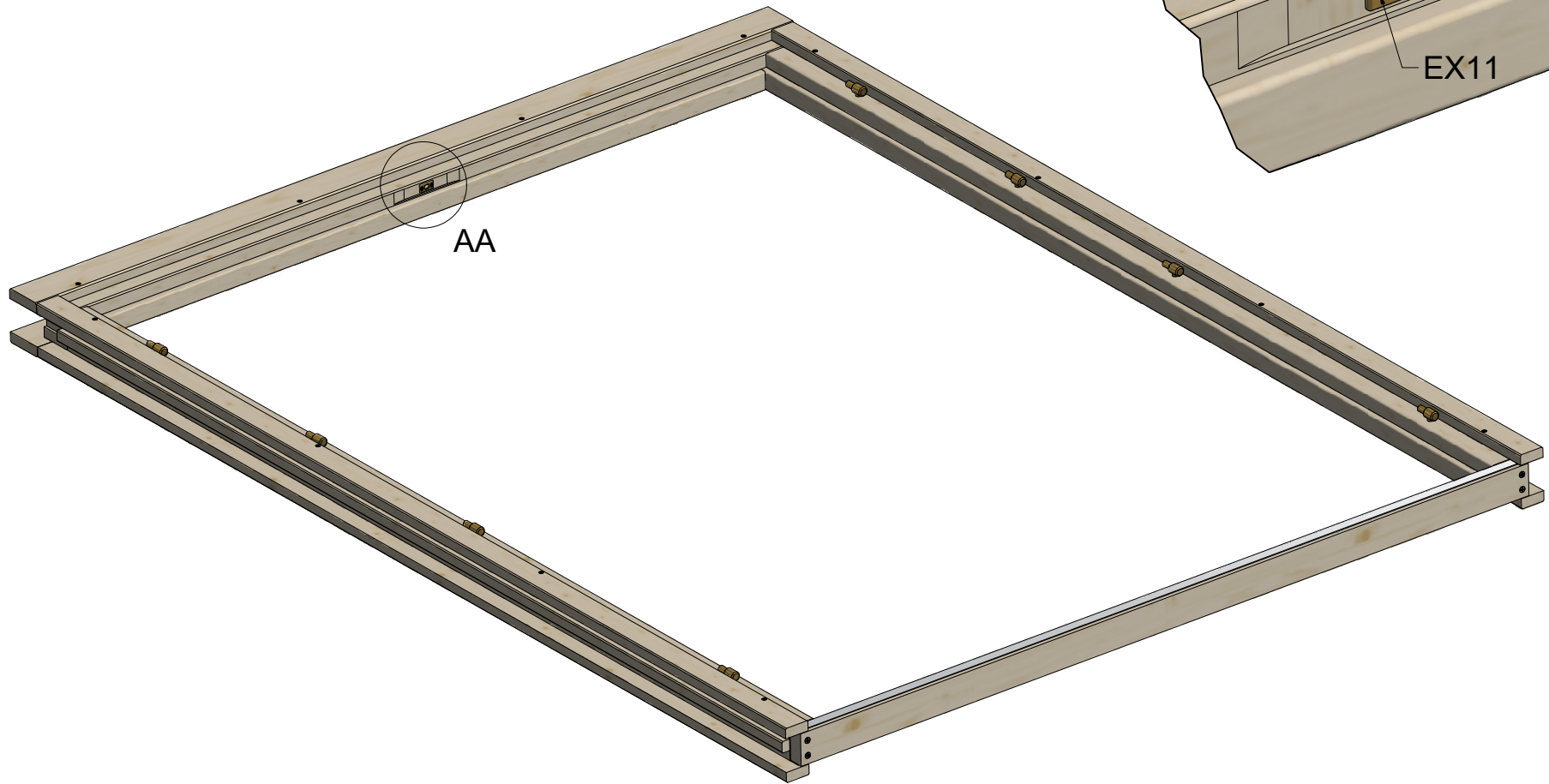
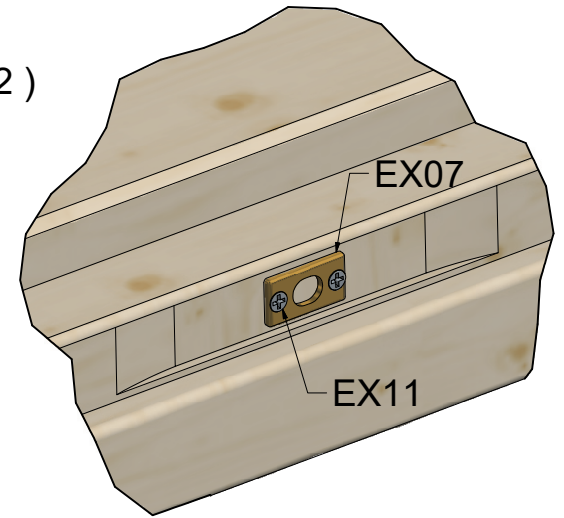

VIEW43 (1 : 20)

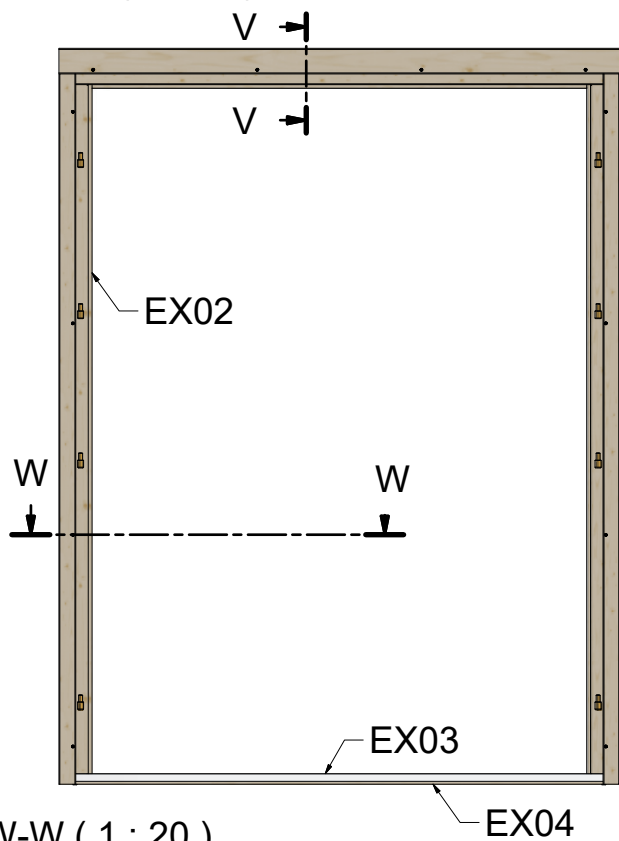

V-V (1 : 4)

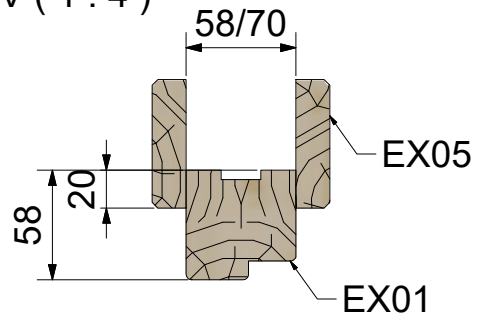







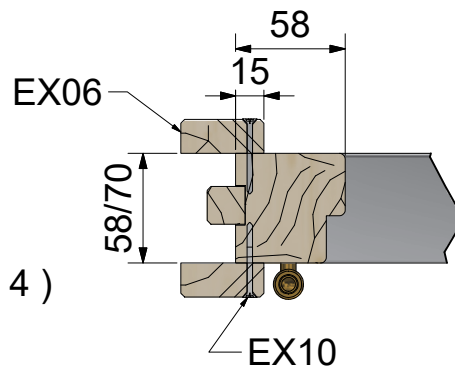









W-W (1 : 20)



Y (1 : 4)

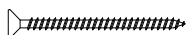

Specification Double Door Frame 58/70mm

Nr	Description	Profile	Amount
EX01		 58 X 58/70	1
EX02		 58 X 58/70	1+1
EX03		 15 X 58/70	1
EX04		 28 X 58/70	1
EX05		 18 X 68	2
EX06		 18 X 44	4
EX07			1
EX08	Screws 5,0 x 70 		4
EX09	Screws 4,0 x 50 		2
EX10	Screws 4,0 x 40 		24
EX11	Screws 3,0 x 30 		2

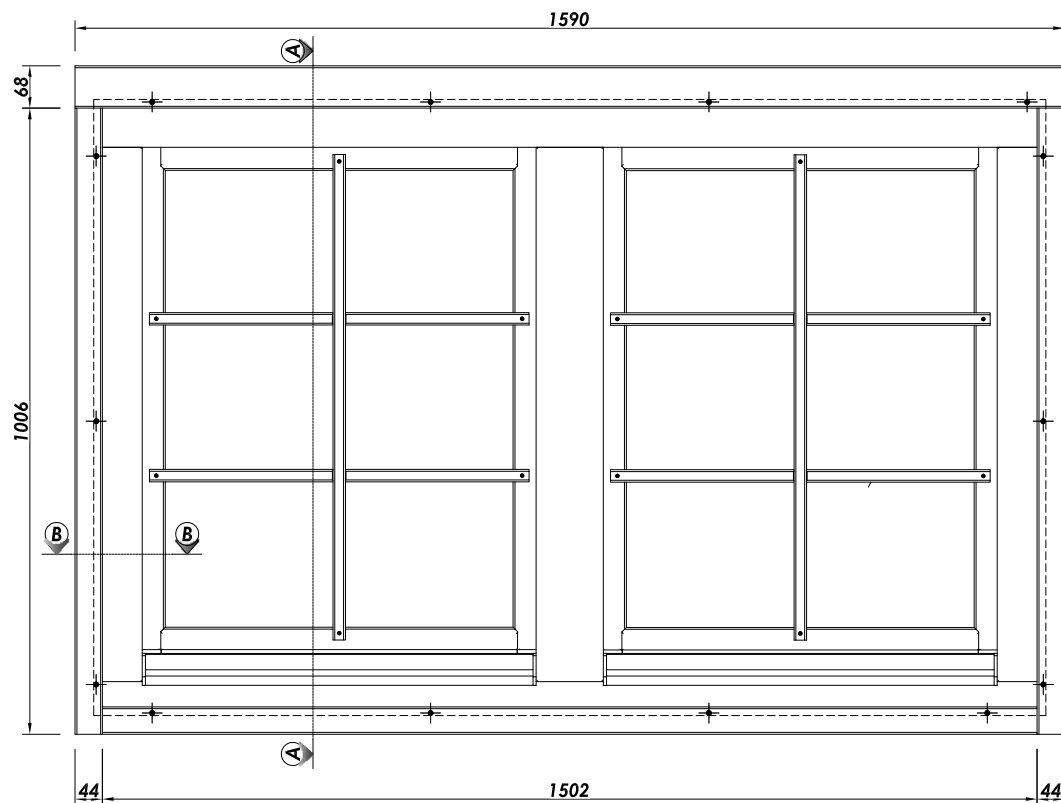

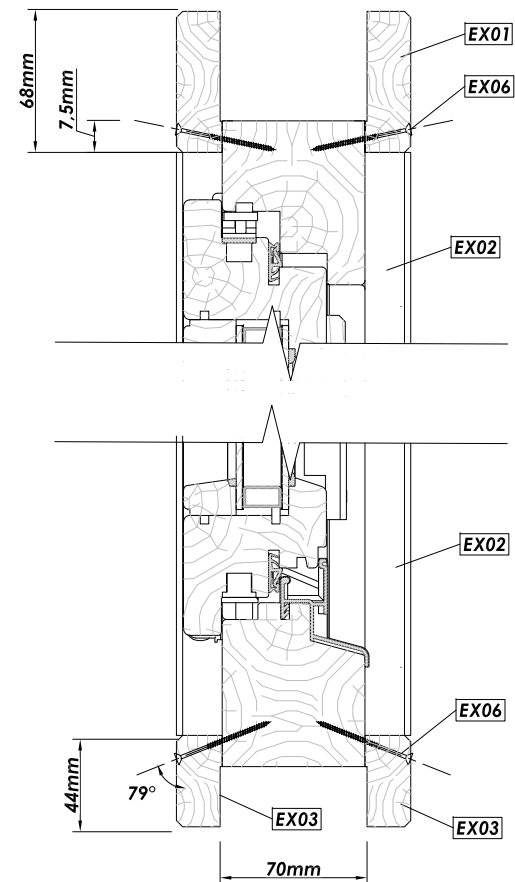

A - A

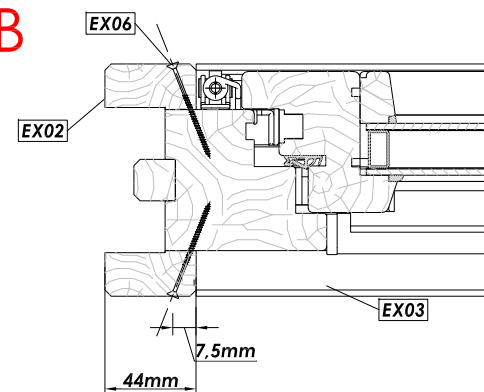

B - B



Premium Window 70mm / 1530 x 990

Nr.	Description	Profile mm	Length mm	Quantity
EX01	Exterior- and interior trim	 22x68	1590	2
EX02	Exterior- and interior trim	 22x44	1006	4
EX03			1502	2
EX04			--	--
EX05			--	--
EX06	Screws 3,5 x 50			28+2