

Göteborg C 70

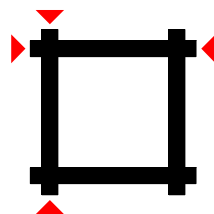

560 x 410 cm

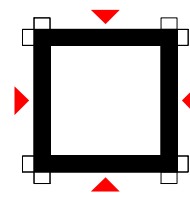

540 x 390 cm

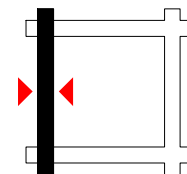



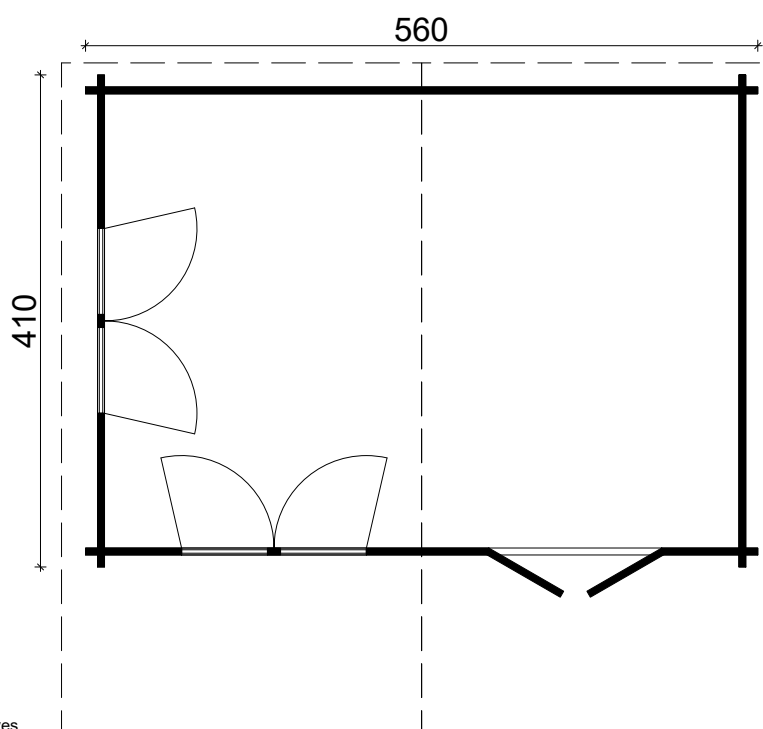









70 mm

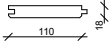
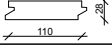
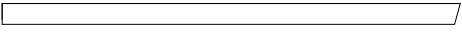
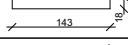
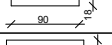
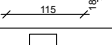

DE
EN
NL
NO
ES
PT
PL
EE
IT
DK
SE
FR

Alle angegebenen Maße sind ca.-Maße
All dimensions are approximate
Alle maten zijn circa maten
Alle vedlagte mål er ca
Todas las dimensiones son aproximadas
Todas as dimensões são aproximadas
Wszystkie wymiary są przybliżone
Kõik mõõdud on ligilähedased
Tutte le misure indicate sono circa
Alle angivne mål er ca.-mål
Samtliga mått är ungefärliga
Toutes les dimensions fournies sont approximatives

Göteborg C 70 mm / 560 x 410 cm - Specification / Teileliste

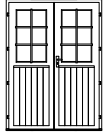
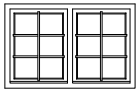
Nr.		 mm	 mm	 x
EX01	Foundation beams / Fundamenthölzer	 60 x 70	5370	2
EX02			3730	11
EX03	Roof boards / Dachbretter		3110	102+2
EX04	Floor boards / Fußbodenbretter		5256	35+1
EX05	Fascia board / Giebelblende 		3150	4
EX06	Gable edge board / Giebelabschlussbrett		3150	4
EX07	Eave edging / Traufenbrett		5600	2
EX08	Eave edging slat / Traufenleiste		5600	2
EX09	Diamond / Raute			2
EX10	Baseboard / Fußleisten		ca. 18,0 m	
EX11	Threaded rod / Gewindestange	∅ 10	2200	4
EX12	Screws / Schrauben 4,0x40 / 4,0x50 / 5,0x70 / 6,0x140 		60 / 750 / 50 / 70	
EX13	Nails / Nägel 1,4 x 35 			50
EX14	Nut, washer / Mutter, Scheibe 	M10		8
EX15	Dowel / Dübel	∅ 16	150	--
EX16	Roofing felt / Dachpappe 		--	--
EX17	Hitblock / Schlaghölzer 	70 x 114	300-400	3
EX18	Double door / Doppeltür 1425 x 1955 mm ISO / 70 mm - R			1
EX19	Double window / Doppelfenster 1530 x 990 mm ISO / 70 mm			2

A-A

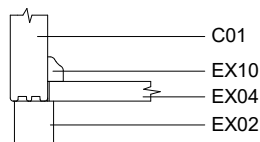

1

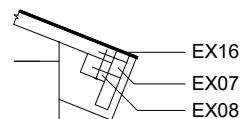

2

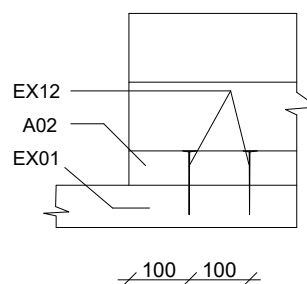



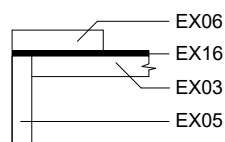















B-B





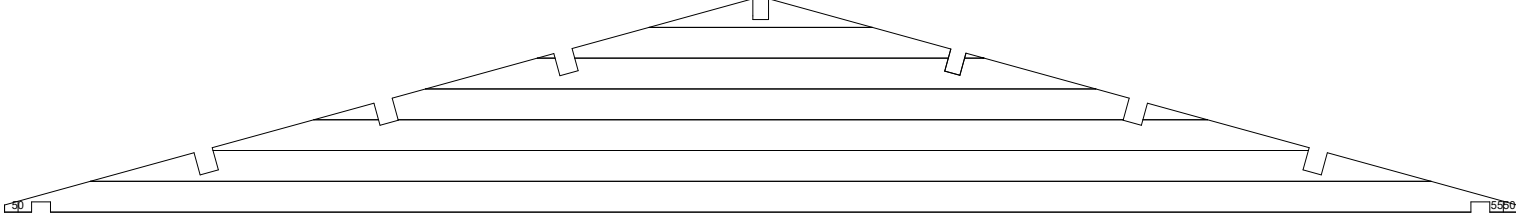
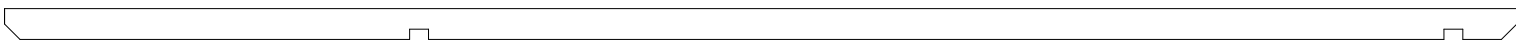









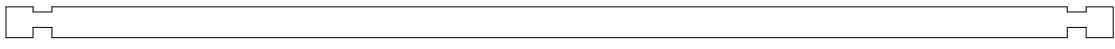
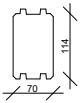
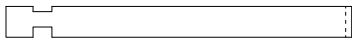

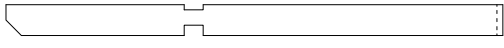
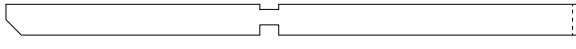
100 / 100

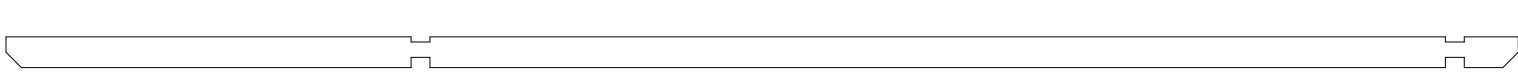
Göteborg C 70 mm / 560 x 410 cm - A; B; LT

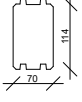
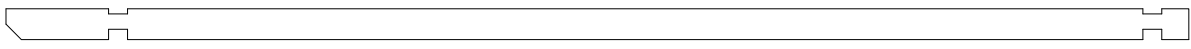
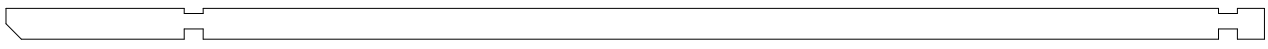
Nr.		 mm	 mm	 x
A01			3360	1
A02			800	1
A03			3360	8
A04			800	26
A05			1020	9
A06			5600	1
B01			5600	1
B02			5600	18
B03 A07			5600	2
LT		 70 x 143	5600	7(6+1)

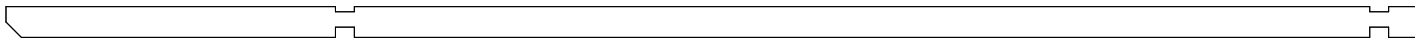
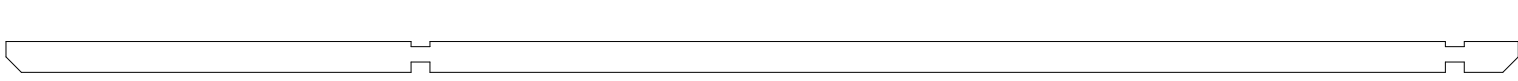
Göteborg C 70 mm / 560 x 410 cm - C; D

Nr.		 mm	 mm	 x
C01			4100	8
C02			1280	15
C03			1560	1
C04			1840	1
C05			2120	1
C06			5220	1
C07			5600	1(1+0)
D01			4100	14
D02			4380	1
D03			4660	1
D04			4940	1
D05			5220	1
D06			5600	1(0+1)

Göteborg C 70 mm / 560 x 410 cm

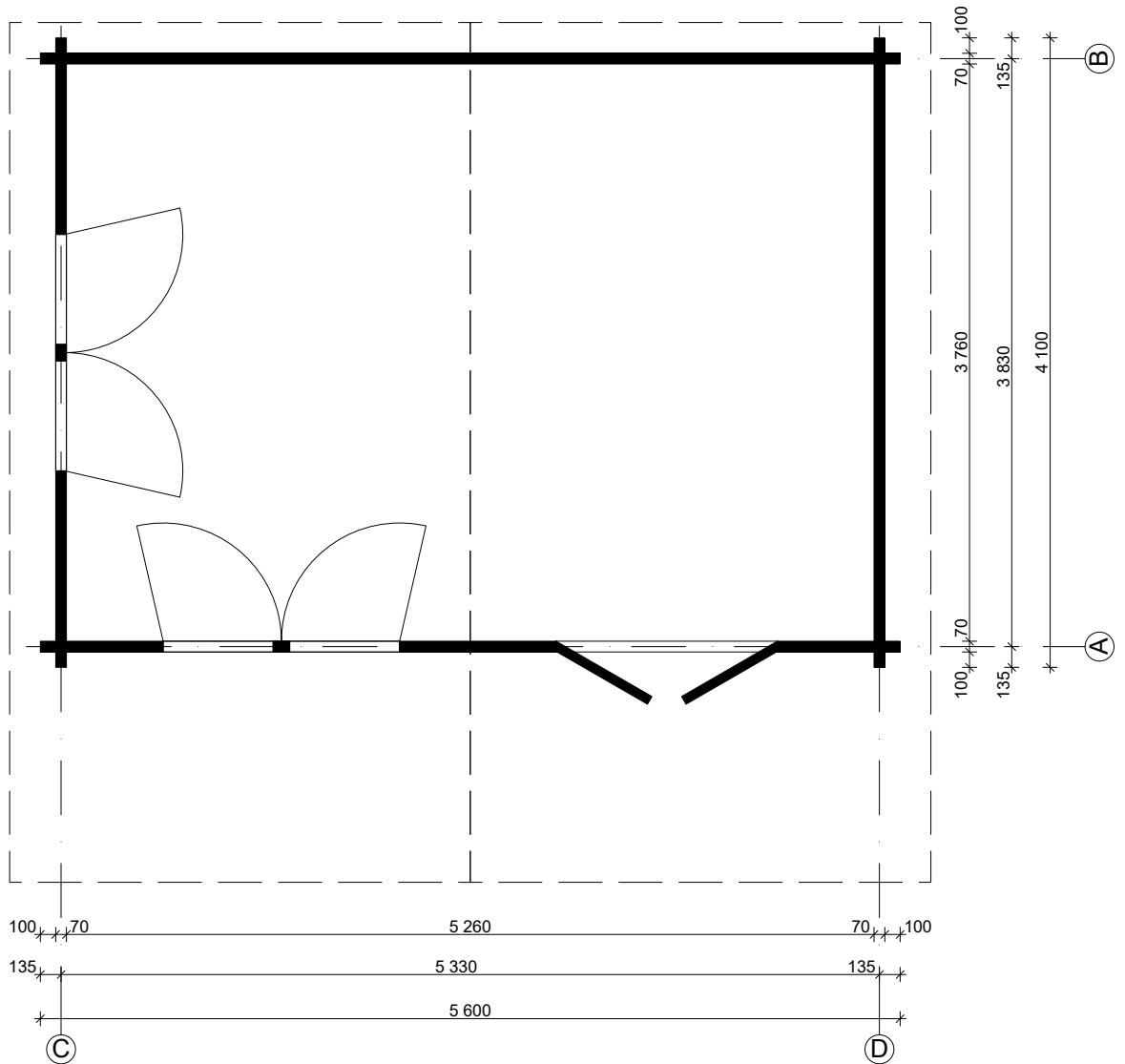
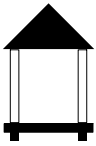
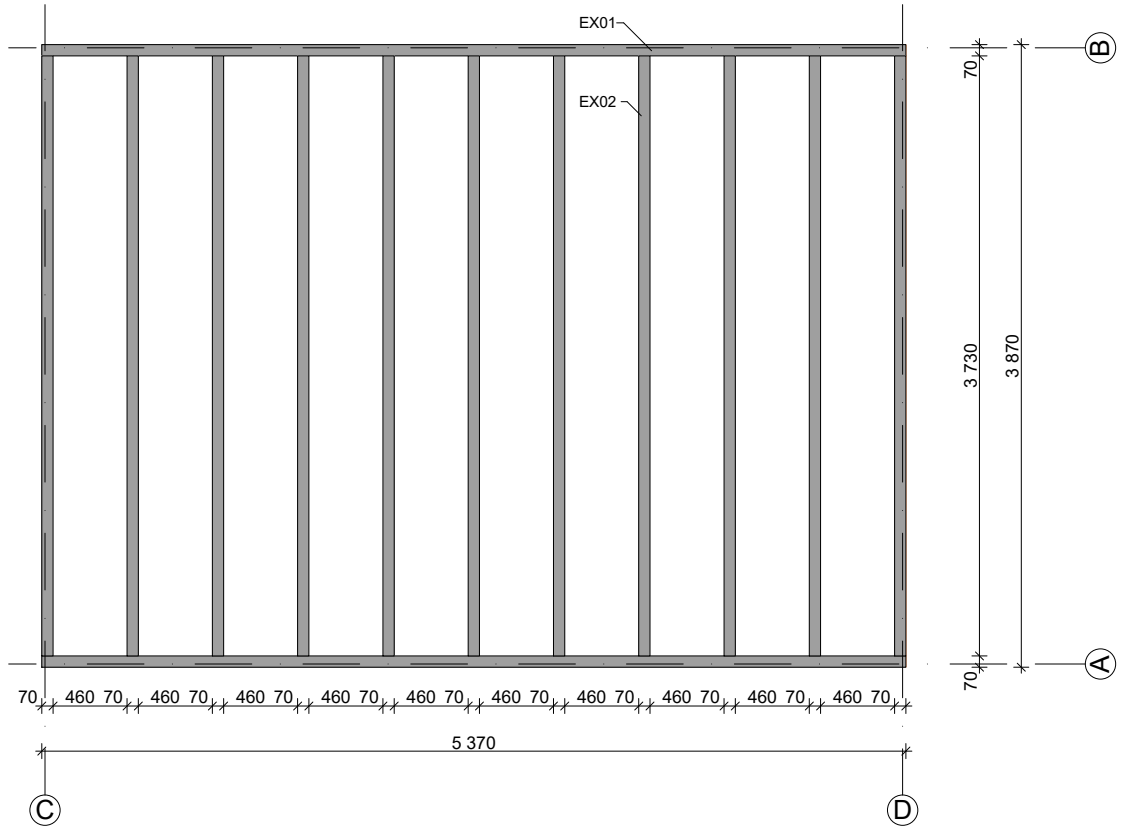
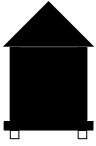

Göteborg C 70 mm / 560 x 410 cm - A; B

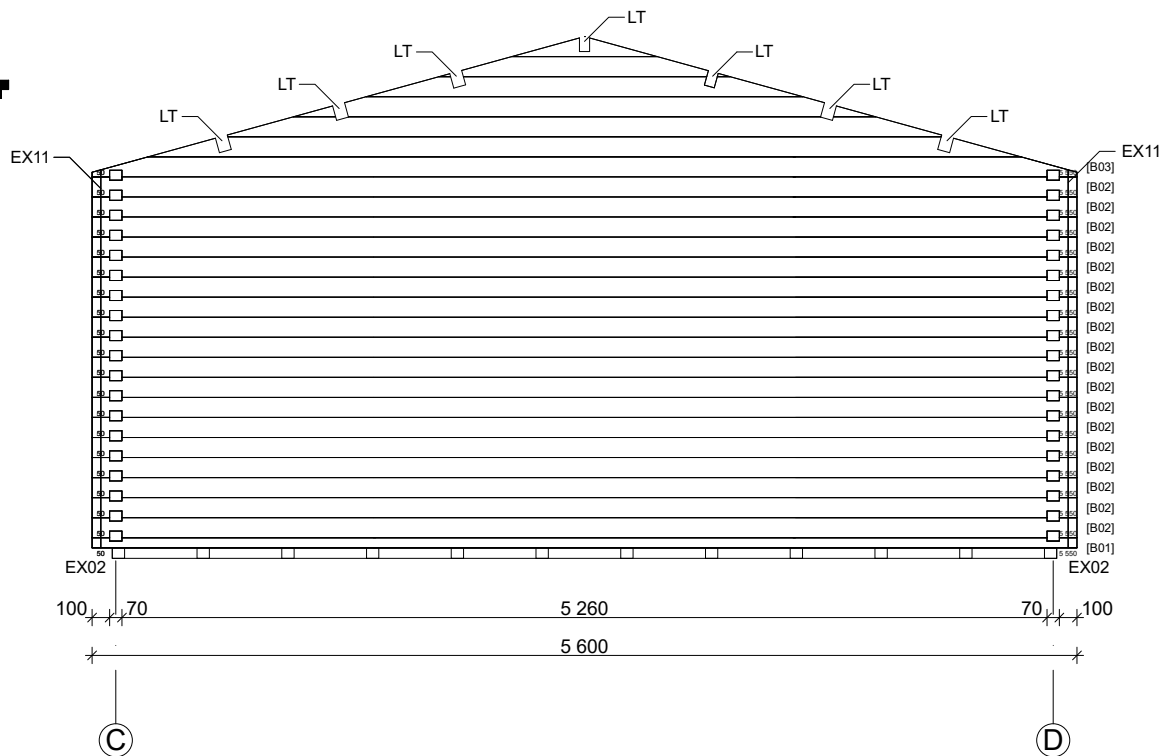
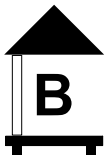
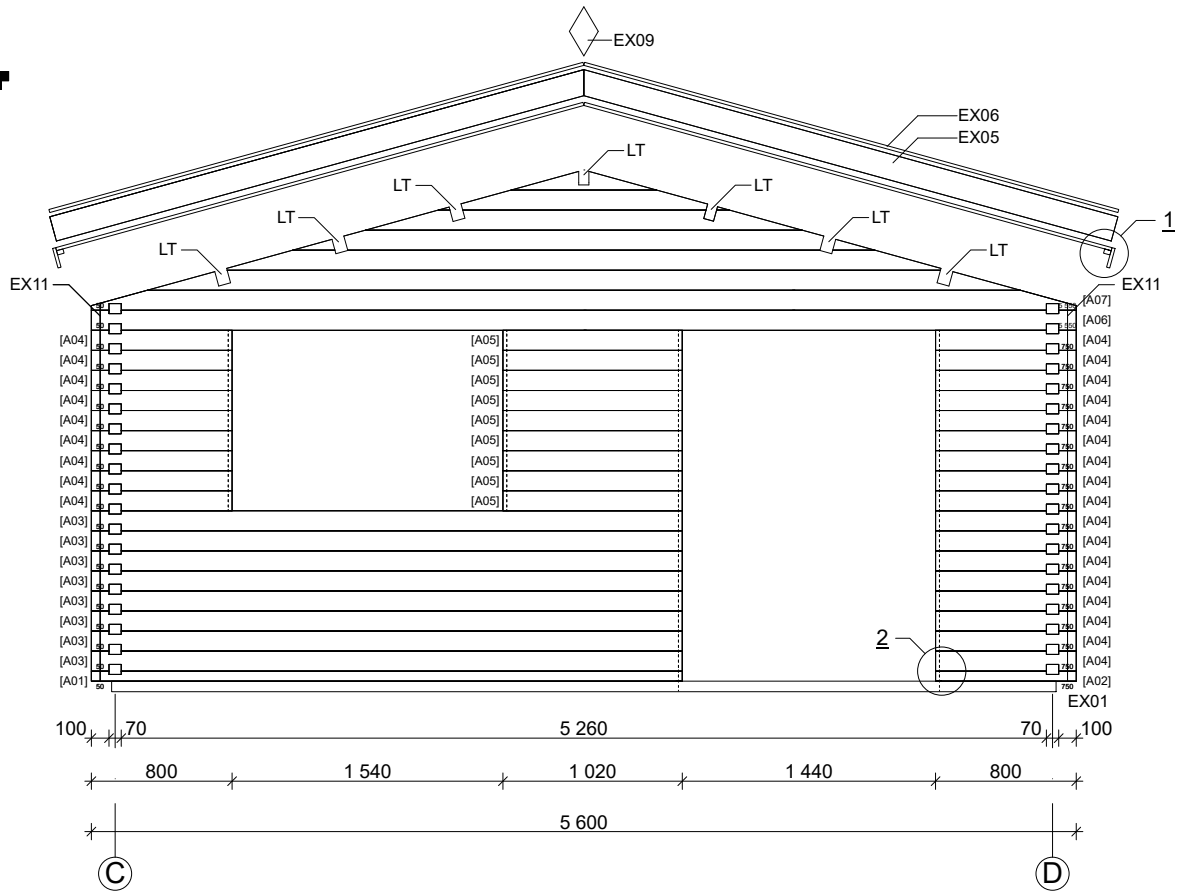
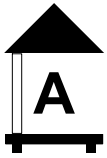

Double Door Frame 58/70mm

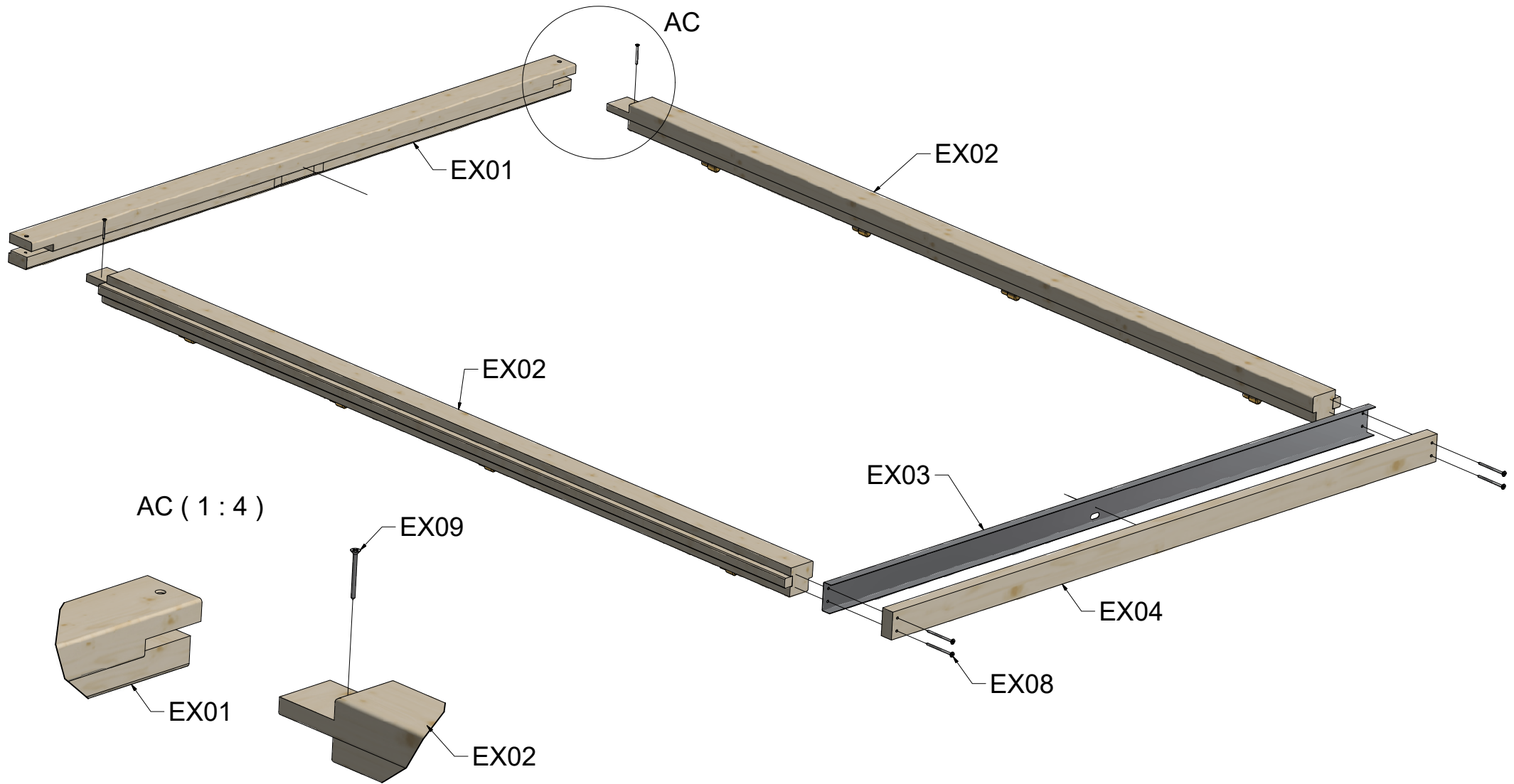

Double Door Frame 58/70mm

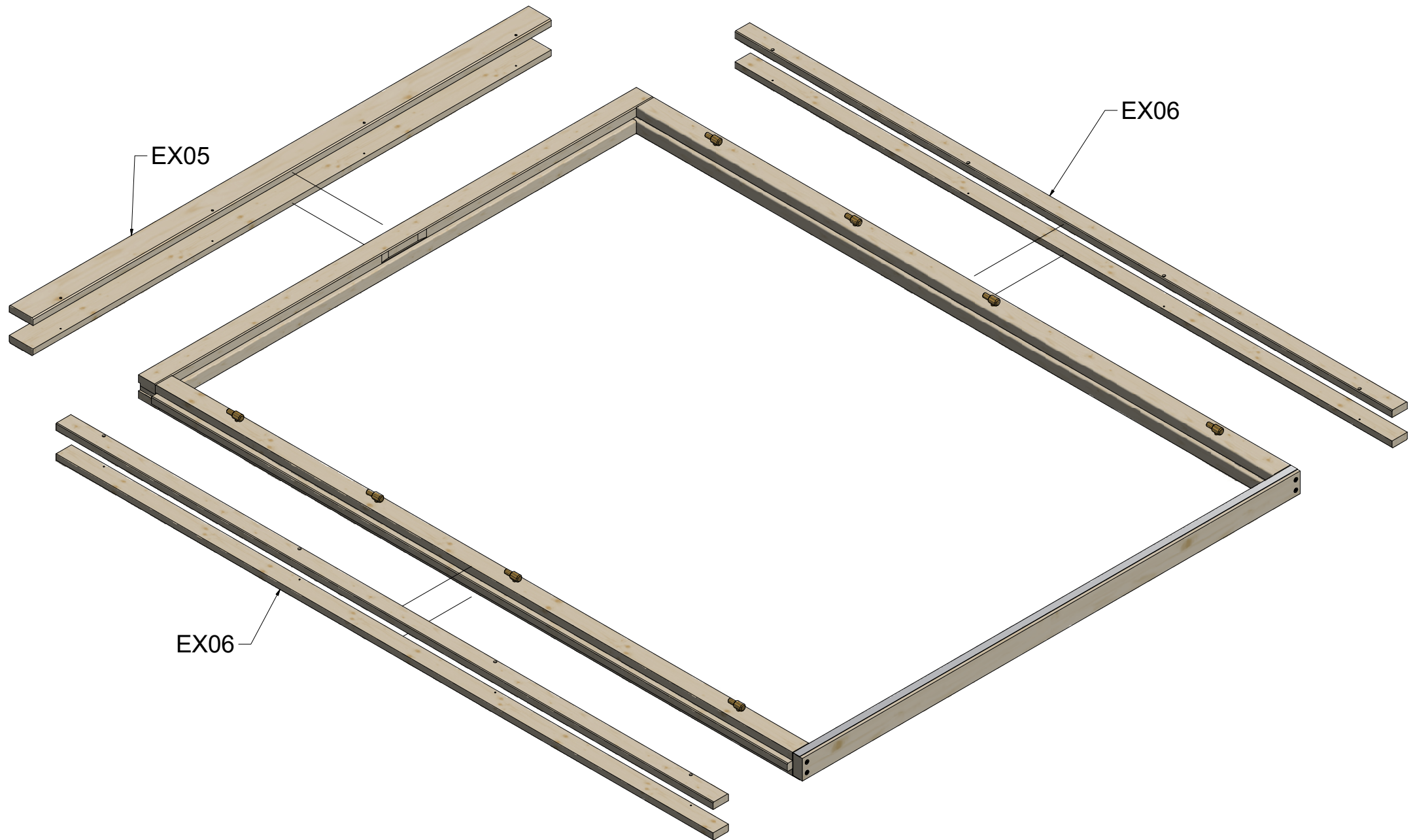

Double Door Frame 58/70mm

AA (1 : 2)

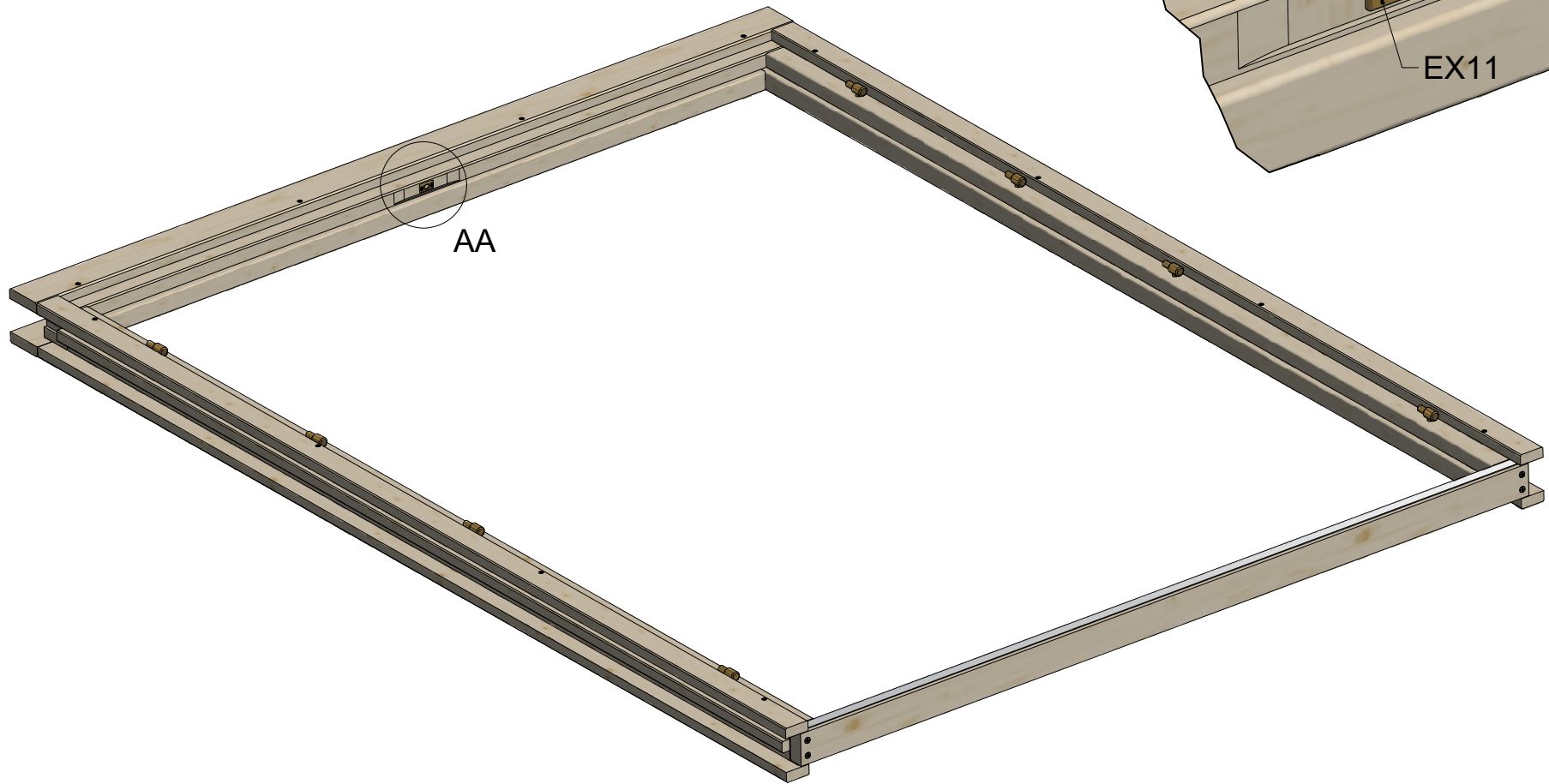
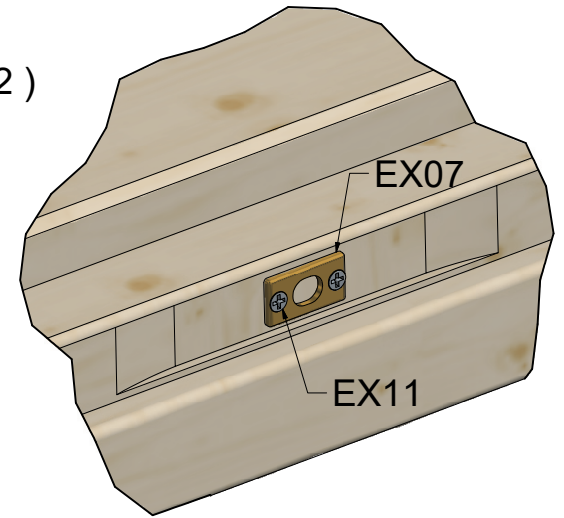

VIEW43 (1 : 20)

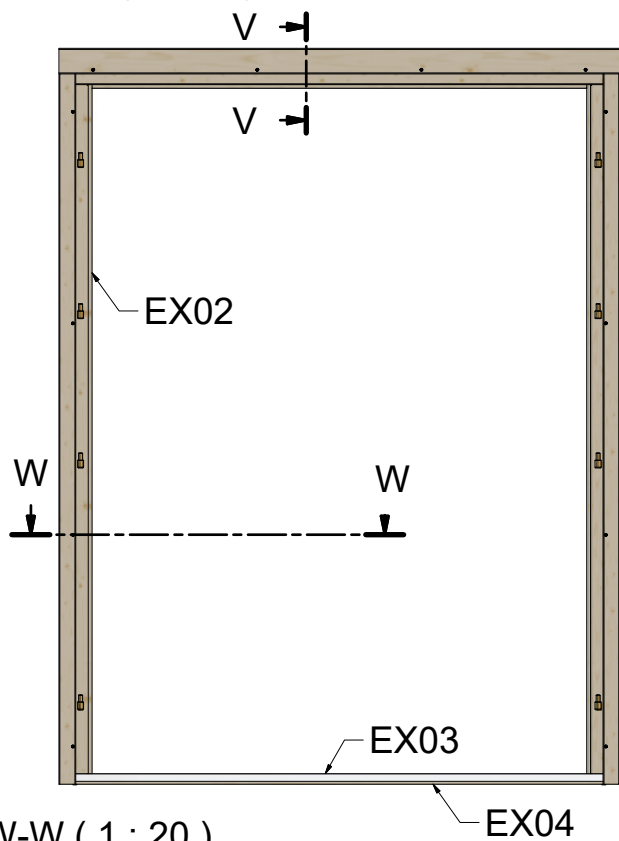

V-V (1 : 4)

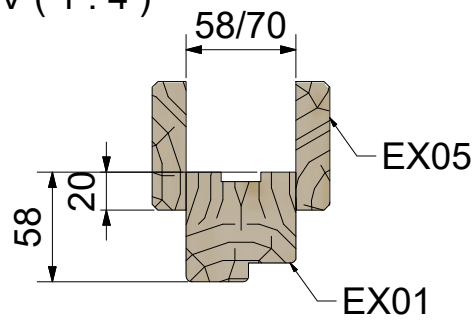







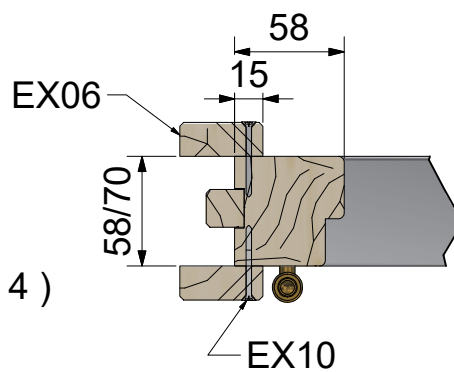









W-W (1 : 20)



Y (1 : 4)

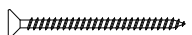

Specification Double Door Frame 58/70mm

Nr	Description	Profile	Amount
EX01		 58 X 58/70	1
EX02		 58 X 58/70	1+1
EX03		 15 X 58/70	1
EX04		 28 X 58/70	1
EX05		 18 X 68	2
EX06		 18 X 44	4
EX07			1
EX08	Screws 5,0 x 70 		4
EX09	Screws 4,0 x 50 		2
EX10	Screws 4,0 x 40 		24
EX11	Screws 3,0 x 30 		2

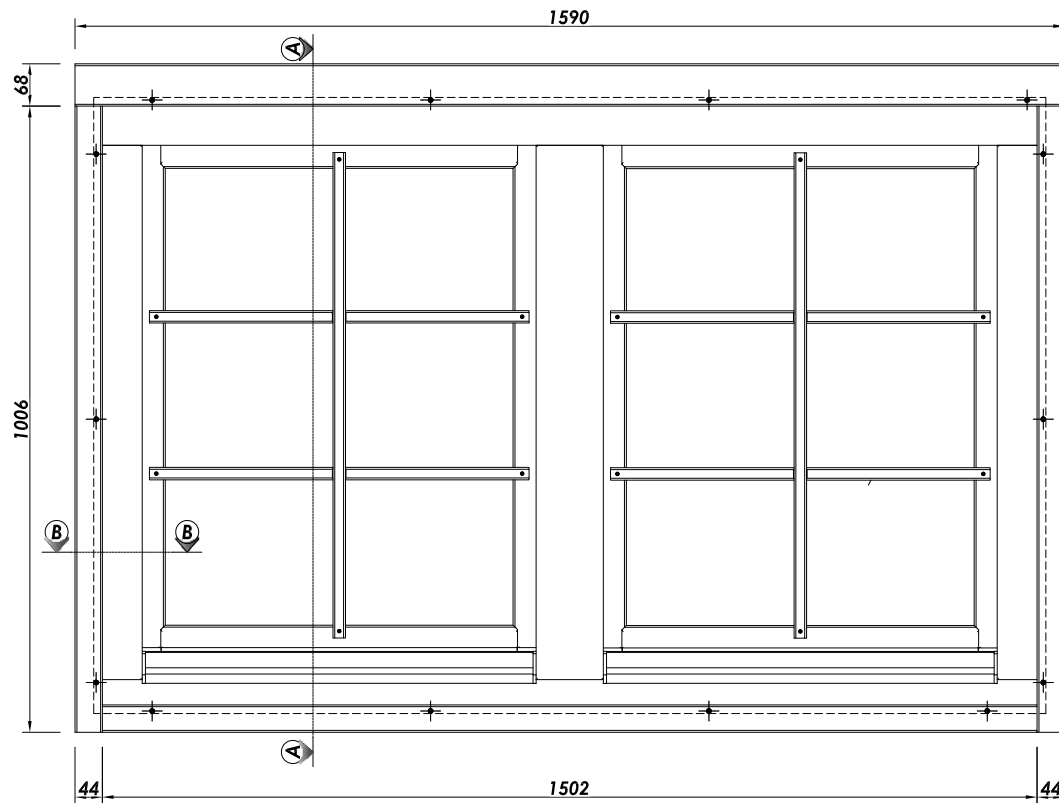

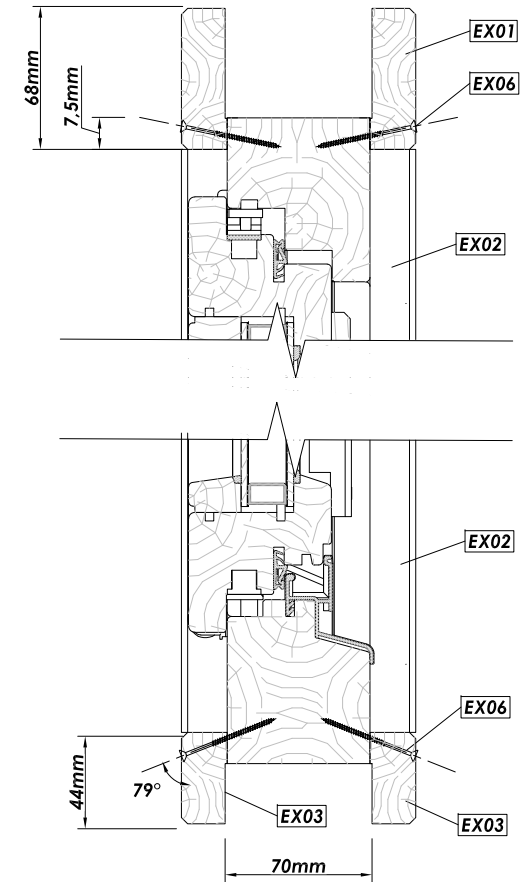

A - A

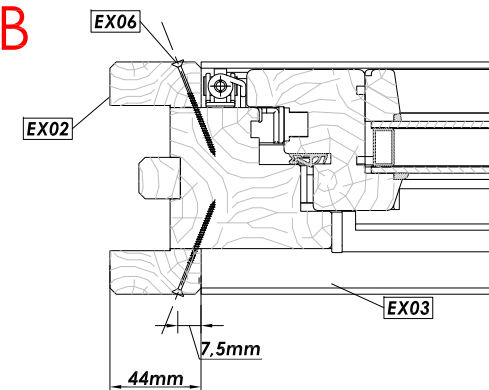

B - B



Premium Window 70mm / 1530 x 990

Nr.	Description	Profile mm	Length mm	Quantity
EX01	Exterior- and interior trim	 22x68	1590	2
EX02	Exterior- and interior trim	 22x44	1006	4
EX03			1502	2
EX04			--	--
EX05			--	--
EX06	Screws 3,5 x 50			28+2