

Pedro B 70

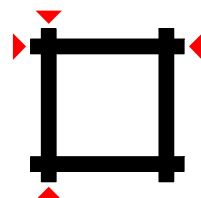

500 x 350 cm

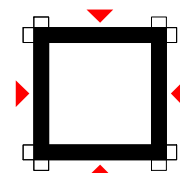

480 x 330 cm

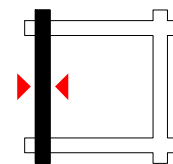



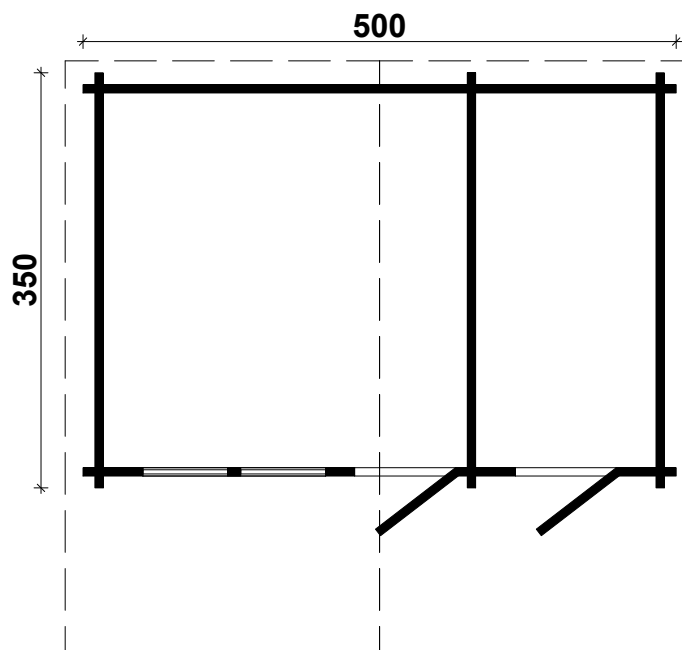
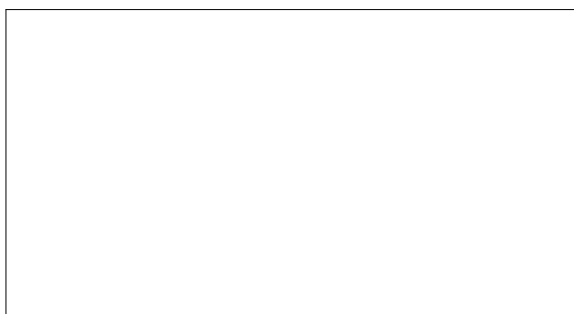









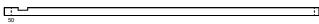

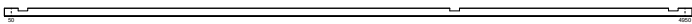
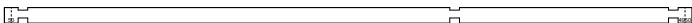

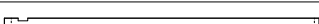



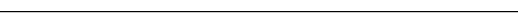

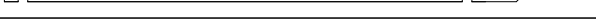
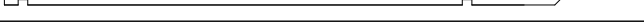

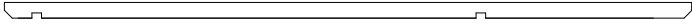
70 mm

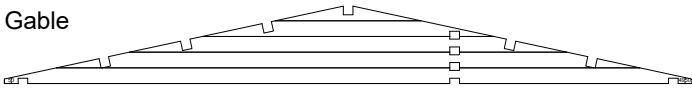

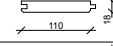
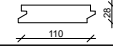
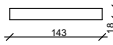
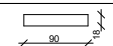
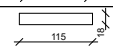
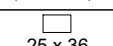
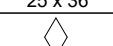
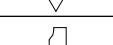
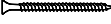
DE Alle angegebenen Maße sind ca.-Maße
EN All dimensions are approximate
NL Alle maten zijn circa maten
NO Alle vedlagte mål er ca
ES Todas las dimensiones son aproximadas
PT Todas as dimensões são aproximadas
PL Wszystkie wymiary są przybliżone
EE Kõik mõõdud on ligilähedased
IT Tutte le misure indicate sono circa
DK Alle angivne mål er ca.-mål
SE Samtliga mått är ungefärliga
FR Toutes les dimensions fournies sont approximatives

Pedro B 70 mm / 500 x 350 cm - Specification

Nr.		 mm	 mm	 x		
001	Foundation beams		4770	2		
002			3130	10		
003			2289/506/505	1/1/1		
004			5000	1		
005			5000	17		
006			3500	45		
007			505	26		
008			2289	8		
009			--	--		
010				506	17	
011				244	9	
012				3780	2	
013				4060	2	
014				4340	2	
015				4620	3	
016					5000	3(1+2)
017	Purlin 					5000
018	Gable 			5000	2	
019	Door 840 x 1955 mm - 70 mm - R				1	
020	Door 840 x 1955 mm - 70 mm - R			1		
021	Double window 1530 x 990 mm - 70 mm - Tilt & Turn			1		
022	Roofing felt				--	
023	Roof board			2775	92+2	
024	Floor board			1518/3065	29+1/29+1	
025	Facia board		2815	4		
027	Gable edge board		2815	4		
028	Eave edging		5000	2		
029	Eave edging slat		2500	4		
030	Diamond			2		
031	Baseboard		ca. 21,8 m			
032	Threaded rod	$\varnothing 10$	2080	4		
033	Screws 4,0x40 / 4,0x50 / 5,0x70 / 6,0 x 140 		100 / 760 / 50 / 60			
034	Nails 1,4 x 35 		50			
036	Nut, washer 			8		
037	Hit block 		300-400	3		

Walls - Pedro B 70 mm

Wall A

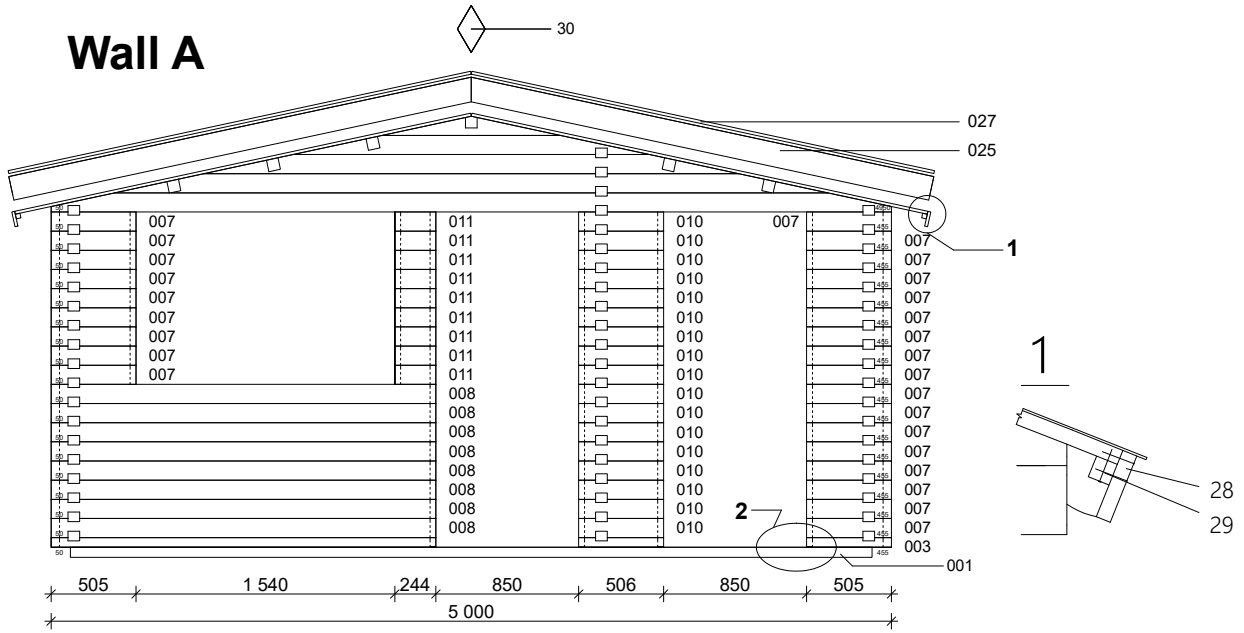

Wall B

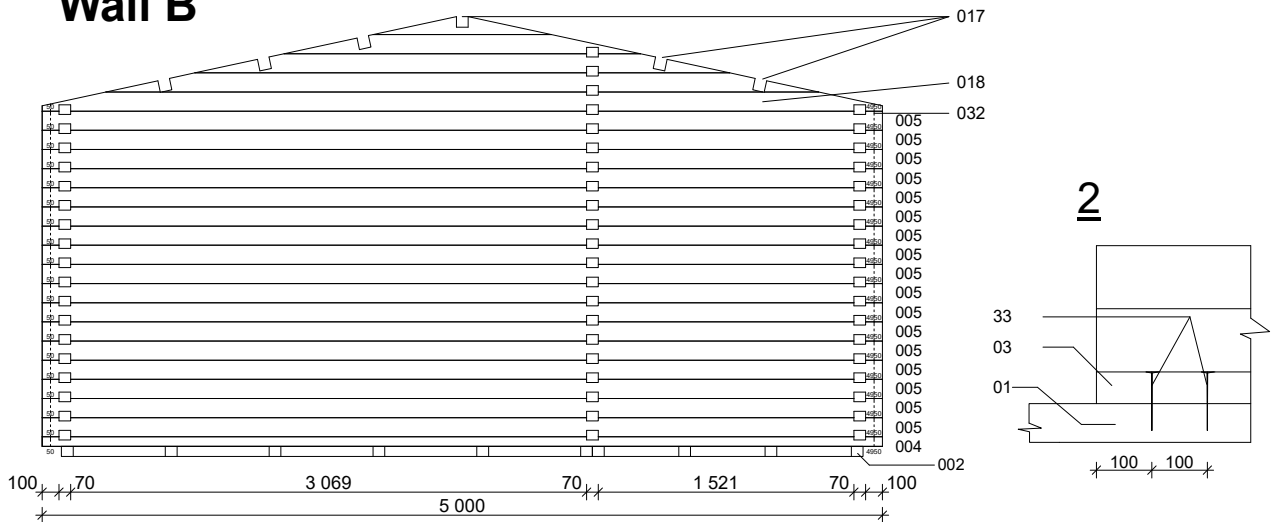

Wall D, E

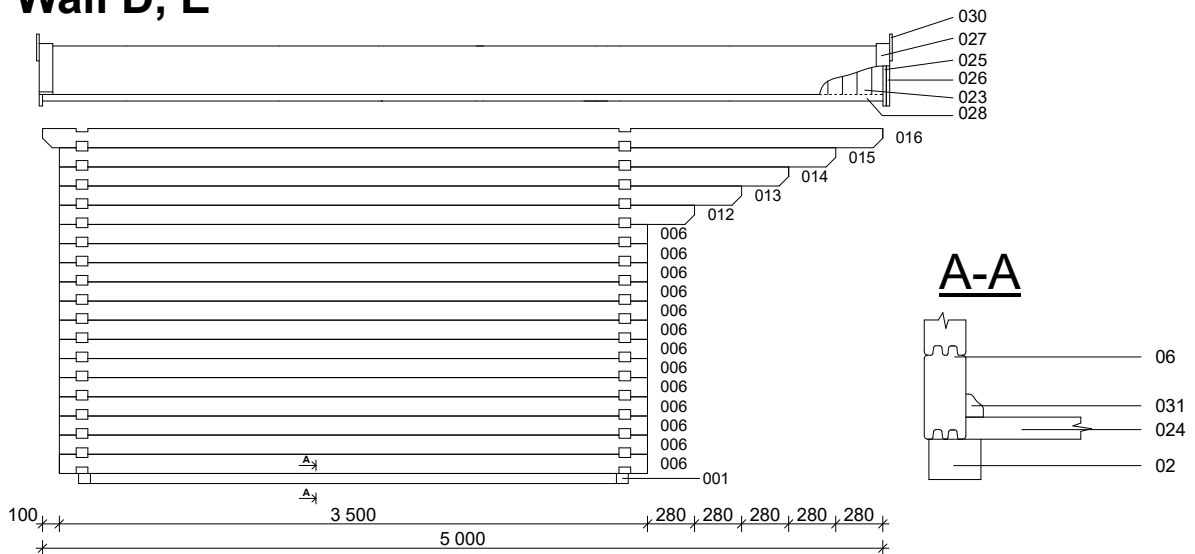

Walls - Pedro B 70 mm

Wall C

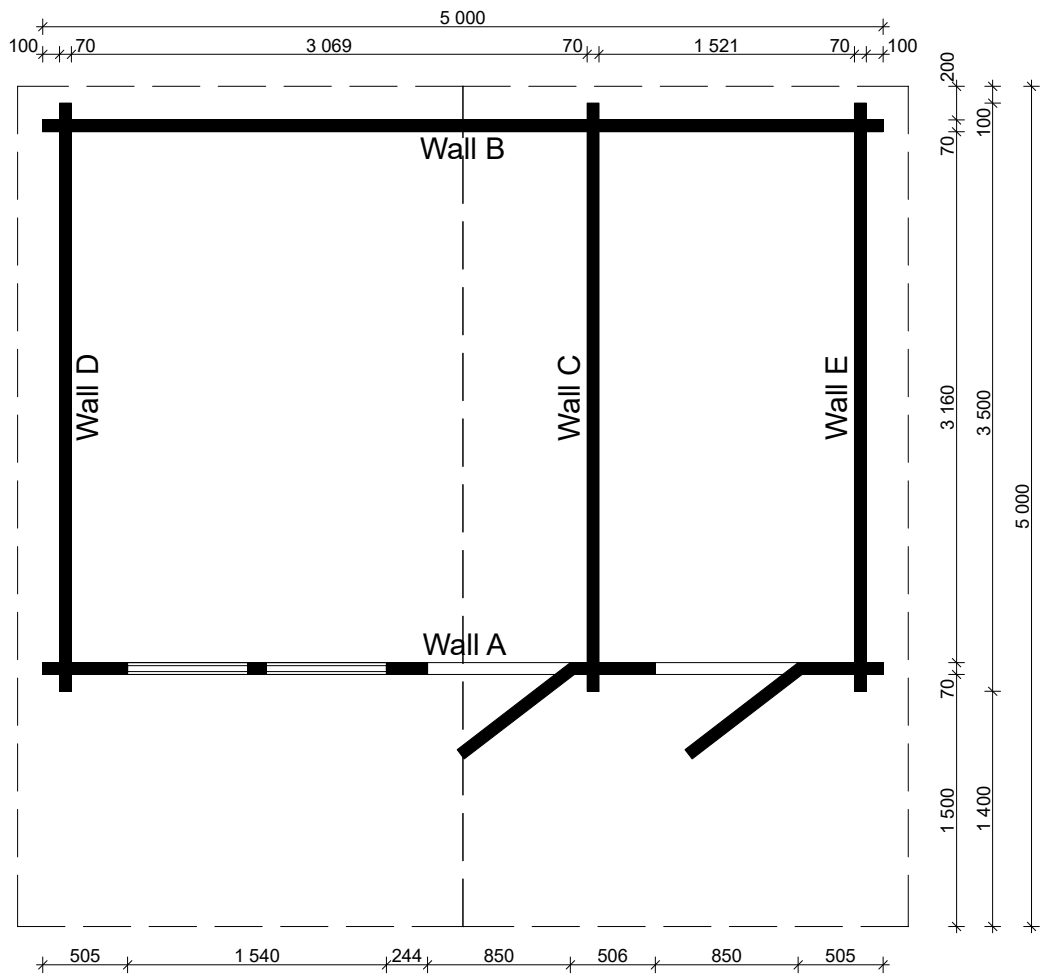
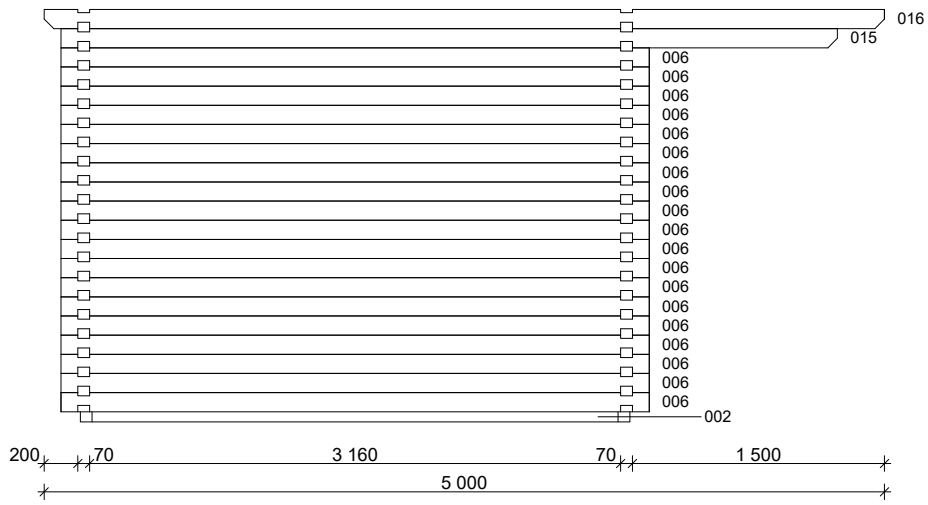

Foundation - Pedro B 70 mm

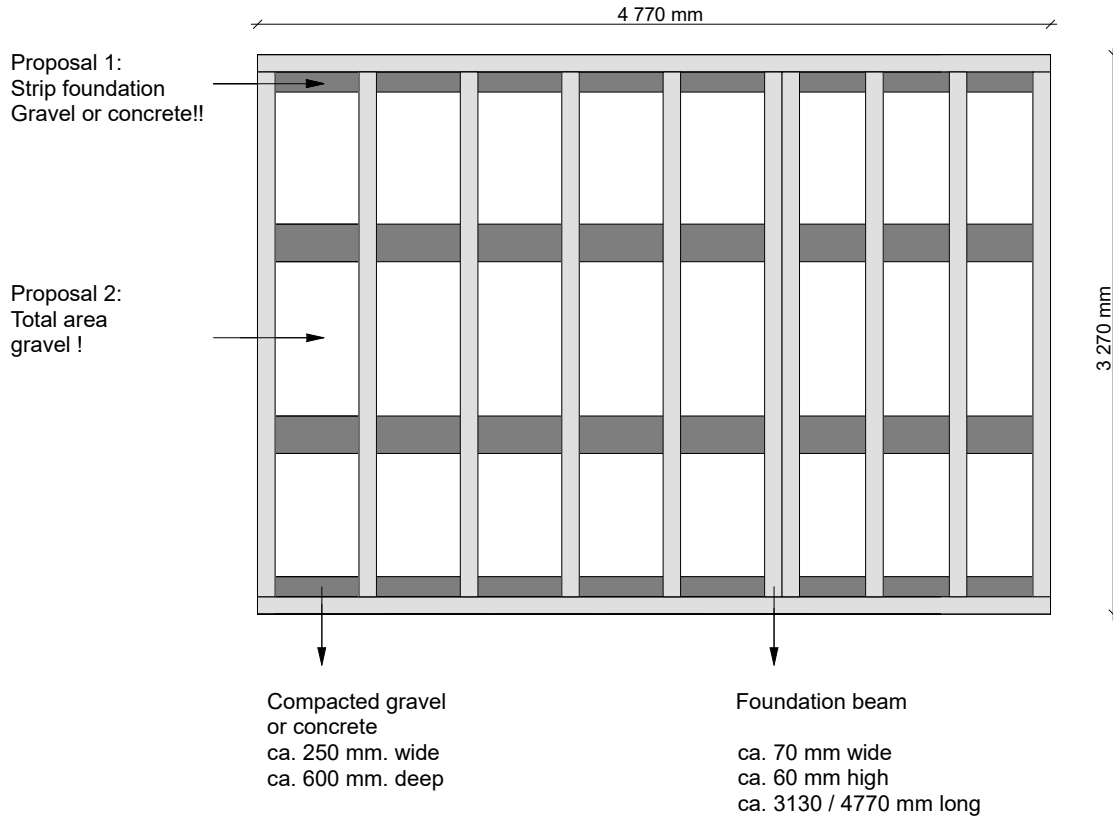

House	Number of foundation beams
Pedro B 70	2 (ca. 70 x 60 x 4770 mm)
	10 (ca. 70 x 60 x 3130 mm)

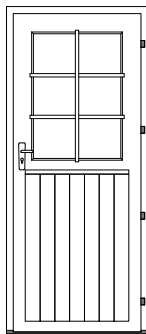

NR. 019
Door 70 mm / DG
840 x 1955 mm
1 st.

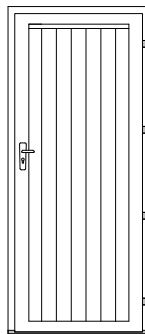

NR. 020
Door 70 mm
840 x 1955 mm
1 st.

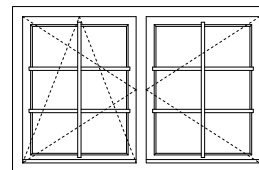

NR. 021
Double window 70 mm / DG
1530 x 990 mm
1 st.

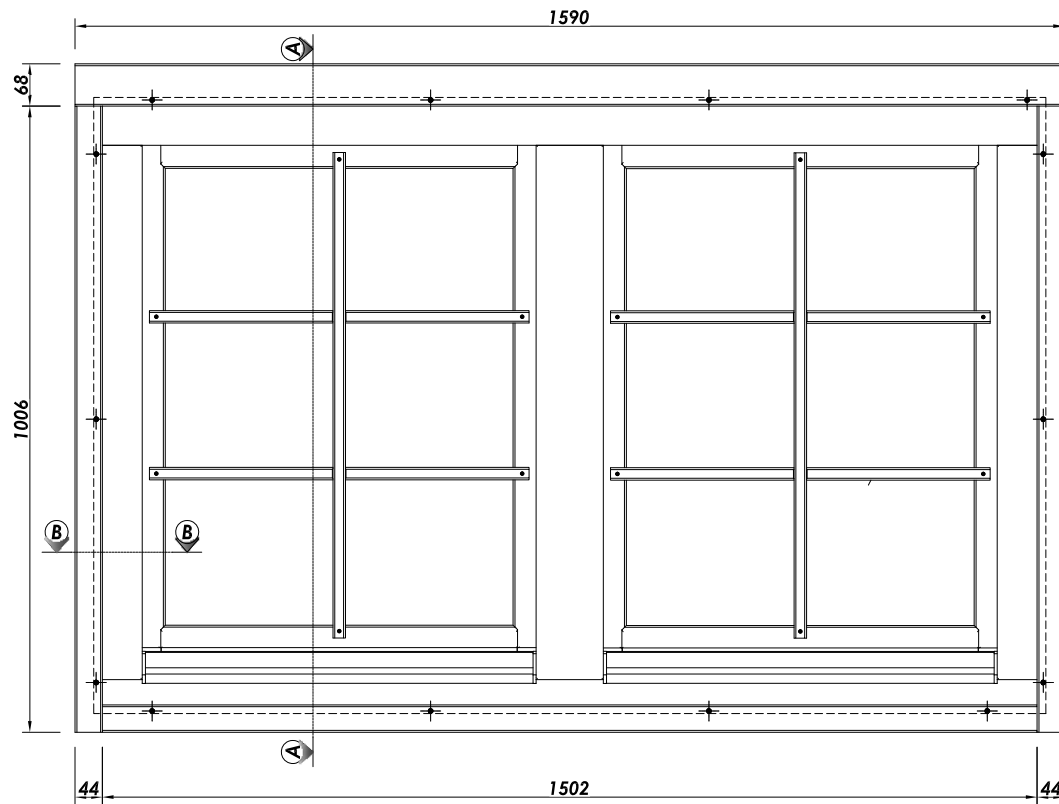

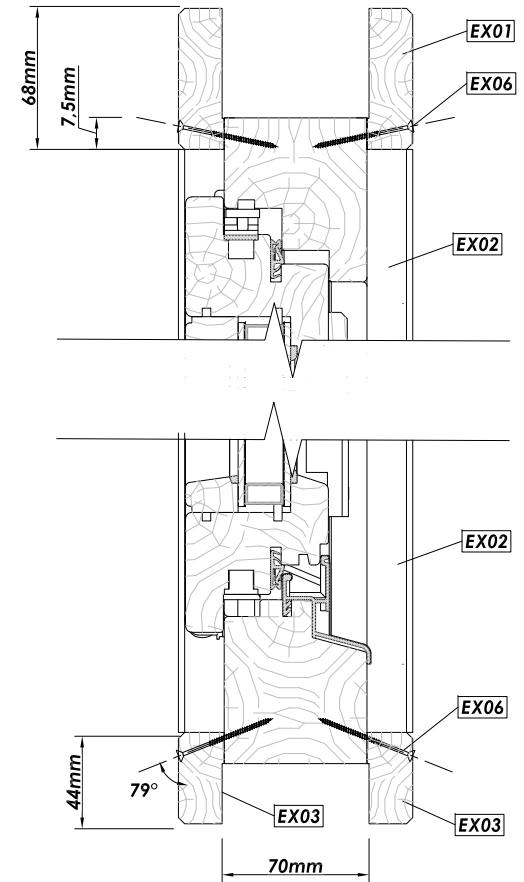

A - A

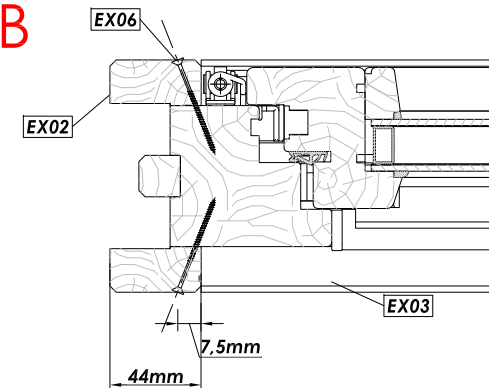

B - B

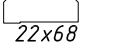
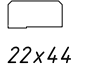

Premium Window 70mm / 1530 x 990

Nr.	Description	Profile mm	Length mm	Quantity
EX01	Exterior- and interior trim	 22x68	1590	2
EX02	Exterior- and interior trim	 22x44	1006	4
EX03			1502	2
EX04			--	--
EX05			--	--
EX06	Screws 3,5 x 50			28+2