



Easy Compact Heatpump Double Duct Air Conditioner



INSTALLATION AND USER MANUAL

BEFORE INSTALLING AND USING THIS AIR CONDITIONER PLEASE READ ALL INSTRUCTIONS CAREFULLY

1. GENERAL INFORMATION

1.1 INTRODUCTION.....	1
1.2 IMPORTANT SAFETY INSTRUCTIONS...	1
1.3 RECEIVING THE GOODS	2
1.4 HANDLING.....	2
1.5 LIST OF ACCESSORIES.....	2
1.6 TECHNICAL FEATURES.....	3

2. INSTALLATION

2.1 POSITIONING OF THE AIR CONDITIONER	4
2.2 PAPER TEMPLATE	4
2.3 DRILLING THE WALL	6
2.4 FASTENING THE BRACKET.....	7
2.5 INSTALLATION OF THE PIPES	7
2.6 FITTING THE GRATINGS.....	8
2.7 FITTING THE AIR CONDITIONER ON BRACKET.....	9

3. USE AND MAINTENANCE

3.1 INTRODUCTION OF LCD ICONS	10
3.2 REMOTE CONTROL FUNCTIONS	10
3.3 HEATING MODE	11
3.4 COOLING MODE	11
3.5 DRY MODE	12
3.6 FAN MODE	12
3.7 SLEEP MODE	13
3.8 AUTO MODE	13
3.9 TIMER OFF FUNCTION	14
3.10 TIMER ON FUNCTION	14
3.11 ELECTRICAL HEAT FUNCTION.....	15
3.12 ON BOARD CONTROL FUNCTION.....	16
3.13 FRESH AIR SYSTEM.....	17
3.14 INSTALL AND CHANGE THE BATTERY	17
3.15 MAINTENANCE.....	18
3.16 PROBLEM SOLVING	19

1.1 INTRODUCTION

PLEASE NOTE. Do not dispose of any packaging until the installation of the air conditioner is completed.

After having removed the packing, check that all the content is intact and complete. (See list of accessories). In the event of missing parts, contact your retailer.

This air conditioner has been designed to cool or heat the air of a room and should only be used for this purpose.

The manufacturer cannot be held liable for damage caused to property or injury to persons or animals due to incorrect installation, regulation and maintenance or improper use.

This air conditioner contains R410A refrigerant: at the end of its life, the disposal of this air conditioner must be in accordance with the strict regulation governing the recycling of this product, please operate with caution during the disposal. Please contact your local authority for regulatory advice.

Do not switch on before having totally assembled the air conditioner and before installing in its correct operating position.

Before starting the appliance, check that it is correctly earthed, according to the legislation in force in the country concerned.

1.2 IMPORTANT SAFETY INSTRUCTIONS



When using electrical appliances, basic safety precautions should always be followed:

Do not place objects on the product or allow objects to obstruct the inlet or outlet openings. Extreme care should be taken when any product is used by, or near children and pets, and whenever the product is left operating and unattended.

Please note:

Before operating the product remove the air conditioner from its packaging and check it is in good condition.

Do not let children play with the packaging, for example plastic bags.

Do not operate any product with a damaged cord or plug, or after the air conditioner malfunctions, has been dropped, or damaged in any manner. Return the air conditioner to an authorised service center for examination and repair to avoid a hazard.

Do not attempt to repair or adjust any electrical or mechanical functions on this air conditioner as this may void warranty, contact your service engineer.

Always operate the product from a power source of the same voltage, frequency and rating as indicated on the product identification plate.

This air conditioner is not intended for use in wet or damp locations.

Do not place the air conditioner near an open flame, cooking or heating appliance, or hot surface.

Do not let the power cord hang over the edge of a table or counter. Arrange the power cord away from an area where it may be tripped over.

Never place the power cord under a carpet or rug. Do not operate the air conditioner in areas where petrol, paint, or other flammable liquids are used or stored.

Do not carry out any cleaning or maintenance or access internal parts until the air conditioner has been disconnected from the mains electricity supply.

Do not alter the safety or regulating devices without the permission and instructions of the air conditioner manufacturer.

Do not pull, remove or twist the electric cable connected to the air conditioner, even if disconnected from the mains electricity supply. Avoid prolonged direct contact with the flow of the air from the air conditioner and the room being closed with no ventilation for a long period of time.

Repair or maintenance work must be carried out by a service engineer or by qualified technicians in compliance with the instructions given in this booklet. Do not alter the appliance, since hazardous situations could be created while the manufacturer of the appliance will not be liable for any damage or injury caused.

This instruction booklet is an integral part of the appliance and should therefore be carefully preserved and always accompany the appliance in the event of transfer to another owner or user or another installation engineer. Should the booklet be damaged or lost, please request an additional.

1.3 RECEIVING THE GOODS

The air conditioner is delivered in a protective packaging and is accompanied by an instruction manual. This manual is an integral part of the air conditioner and should therefore be carefully read and preserved. When the air conditioner is unpacked, please check that the air conditioner and the accessory pack are complete and undamaged.

1.4 HANDLING

Be fully aware of the weight of the air conditioner before attempting to lift it. Take all necessary precautions to avoid damaging the product or causing personal injury

It is advisable to remove the packaging only when the air conditioner has been located in the point of installation

Carefully remove the adhesive strips positioned on the air conditioner

Packaging components must be disposed correctly and not left within reach of children, since they are a potential source of danger

1.5 LIST OF ACCESSORIES(P0)

- 1.FASTENING BRACKET
- 2.REMOTE CONTROL
- 3.REMOTE CONTROL HOLDER
- 4.DRAINAGE PIPE
- 5.EXTERNAL GRATING
- 6.AIR DISCHARGE PIPE (160 mm.)
- 7.AIR INTAKE PIPE (150 mm.)
- 8.KIT OF SCREWS
- 9.GRATING FIXING CORD
- 10.INSTRUCTION MANUAL
- 11.PAPER TEMPLATE FOR WALL DRILLING
(See page)
12. 160mm RING
13. 150mm RING

wz-28Ec can be connected only to a supply with system impedance no more than 0.193 ohm. In case necessary, please consult your supply authority for system impedance information.

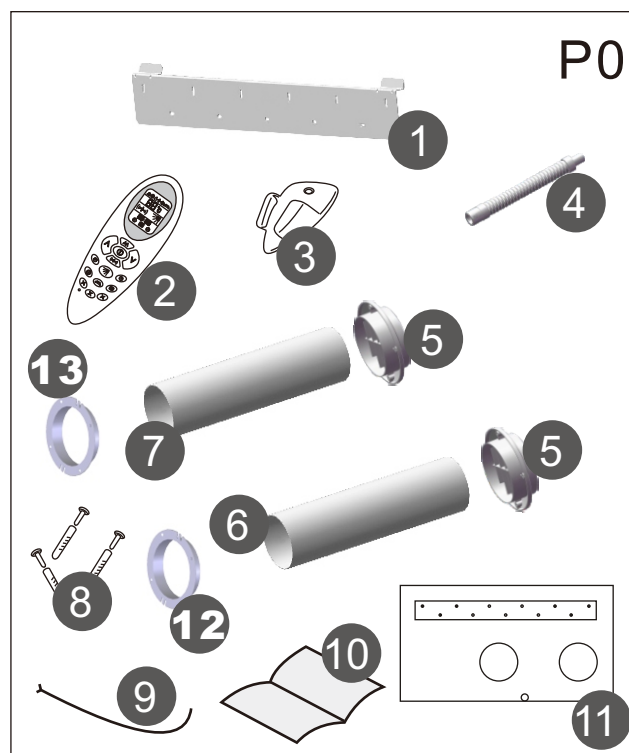

This product has been manufactured to comply with 2006/95/EC and with amendments 92/31/EEC and 93/68/EEC



Waste electrical products should not be disposed of with household waste. Please recycle where facilities exist. Check with your Local Authority or retailer for recycling advice.



Any batteries used in the remote control contain materials, which are hazardous to the environment. They must be removed from the remote control when they reach the end of their life and disposed of responsibly.

1.6 TECHNICAL FEATURES(P1,P2)

Model	Easy Compact Heatpump
Cooling capacity * W (BTU/h)	2565 (9000)
Heating capacity * W (BTU/h)	2555 (9000)
Electrical Heat *W (BTU/h)	500 (1700)
Rated voltage (V)	230
Absorbed power in cooling* (W)	924
Absorbed current in cooling* (A)	4.2
Absorbed power in heating* (W)	831
Absorbed current in heating* (A)	3.8
Air flow (m ³ /h)	400
Noise level (dB A)	50
Dehumidification capacity* (L/24h)	22.5
Optional temperature (remote control)	18-30°C
Fuse (T3.15L)	250V
Refrigerant	R410A
Global warmer potential (GWP)	2088
Dimensions H/W/D(cm)	58/100/24.5
Weight (Kg)	48

*The above datas could be change in order to improve the performances

STANDARD TEST CONDITIONS -EN 14511-

OPERATING CONDITIONS IN COOLING AND DEHUMIDIFICATION MODE

- Inside 27°C DB; 19°C WB
- Outside 35°C DB; 24°C WB

OPERATING CONDITIONS IN HEATING MODE

- Outside 7°C DB; 6°C WB
- Inside 20°C DB

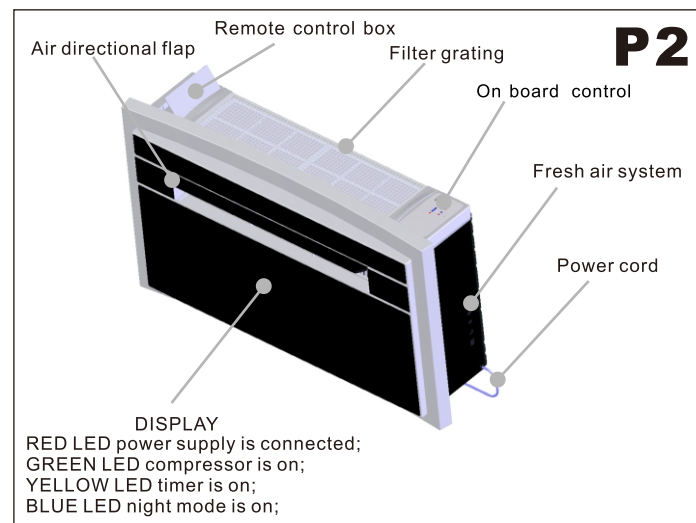
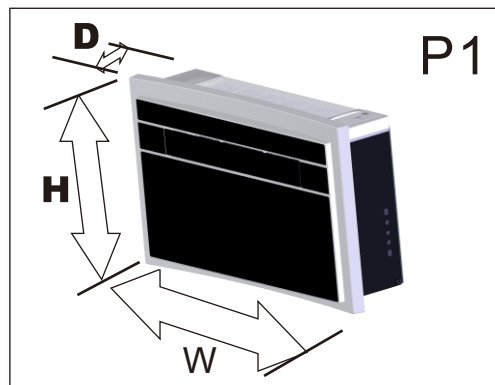
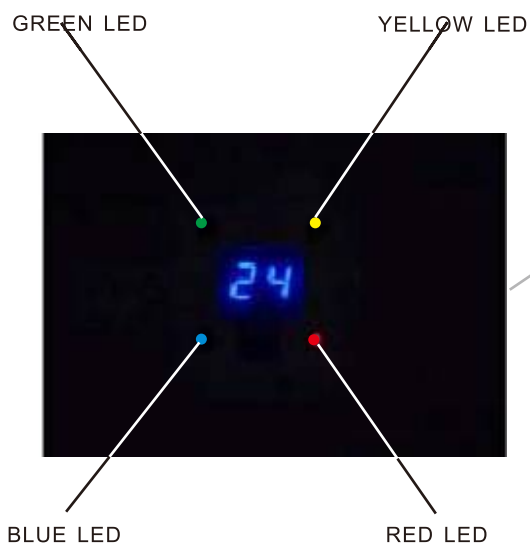

The display will show both setting temperature and ambient temperature. After adjusting the setting temperature, the setting temperature will flash 15 times on the display, then the display will show the ambient temperature for 70 seconds. After that, the display will be off until next adjustment.

2.1 POSITIONING THE AIR CONDITIONER (P3)

To maintain the best performance from your air conditioner, prevent breakdowns or hazards, you must position it correctly. Please follow the guidelines and instruction below in full, as failure to do so could cause potential installation problems.

- The air conditioner must be installed on an exterior wall that has access to the outside with a minimum of 2 meters clearance to the outside.

- The air conditioner must be fitted leaving room all around as illustrated in the paper template

- The wall on which the air conditioner is installed must be sturdy and able to withstand the weight of the air conditioner.

After determining the best place for installation as described above, please check to ensure that the wall can be drilled in the chosen area without interfering with other structures or installations (beams, piers, pipes, wires, etc.).

Please also ensure that there are no obstacles on the outside of the wall, which may obstruct air circulation through the drilled holes, for example: plants and their leaves, slats or panelling, drain pipes, overflows and gratings, etc.). Any obstruction could interfere with the correct performances of the air conditioner.

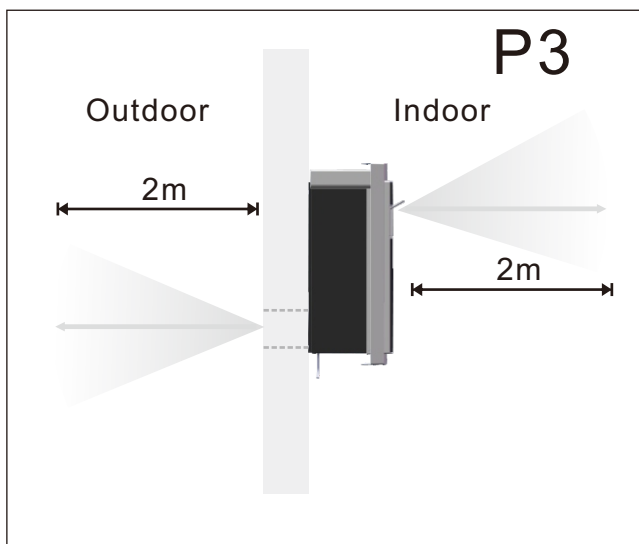

2.2 PAPER TEMPLATE (P4)

Fasten the template to the wall once the following guidelines have been thoroughly checked.

- Do not drill any holes until you are completely confident that there are no obstacles in the area you wish to drill and there are no obstructions, which could be hidden by the construction of the wall, for example: Electrical wiring water & gas pipes or supporting lintels or beams.

- Ensure that a spirit level is used, as the air conditioner must be level.

- Follow the installation instructions in full.

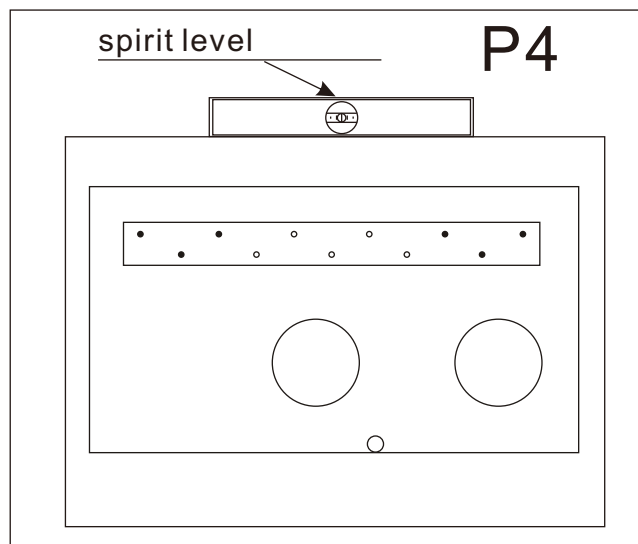

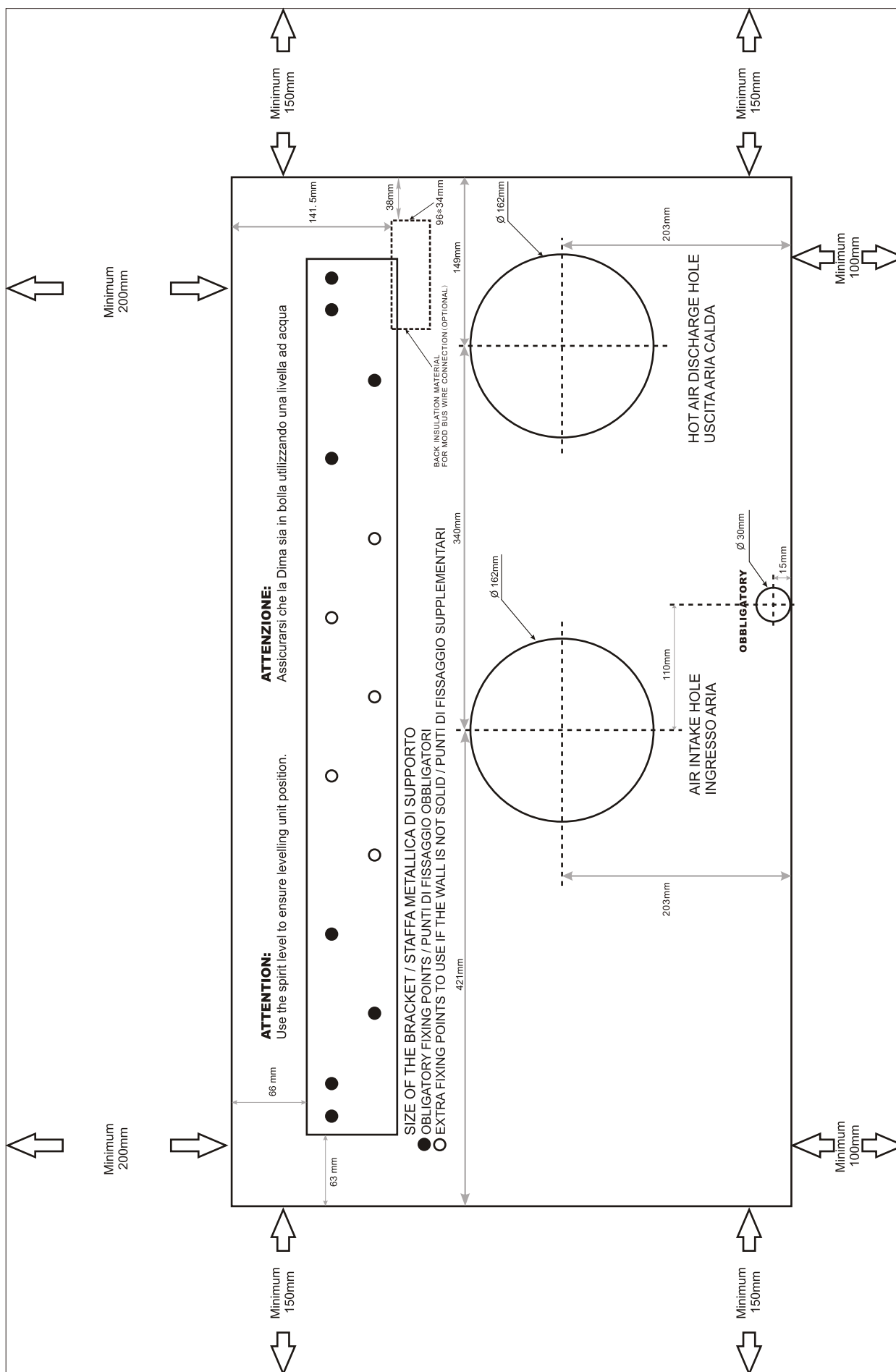

2.3 DRILLING THE WALL (P5)

Please note: If you are drilling the hole above ground floor level, please ensure that an area has been secured and while the holes are drilled the outside area is supervised, until drilling has been completed.

INTAKE AND OUTLET HOLES

- This operation should be carried out using the proper tools (diamond tip or core borers drills with high twisting torque and adjustable rotation speed).
- Fasten the template to the wall taking care to check the distance from the floor and or ceiling and keep it horizontal by using a spirit level.
- Use a pilot drill to mark the centre of each core hole to be drilled.
Use a core boring head having a diameter of 162 mm to drill the two holes for intake and outlet the air.

 It is recommended that the holes must have a slightly downward inclination of 3-5 degrees to prevent any backflow of water from the pipes.

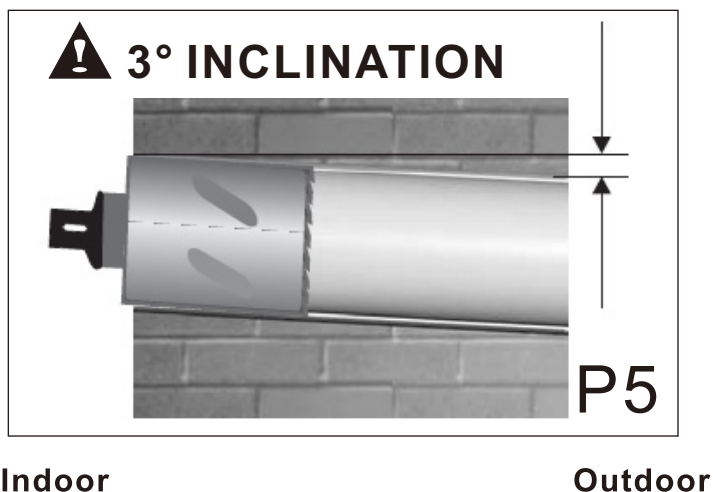

DRAINAGE HOLE(P13)

This air conditioner has a double system to drain the condensate moisture automatically. Before install the Air Conditioner choose which is the suitable system for your installation. Please read carefully the follow instructions.

System "A": drill a hole through the wall measuring 30mm in diameter in the position shown in the paper template. Drainage occurs by gravity. **For this reason, it is essential for the drain line to have a minimum downward inclination at least 3 degrees throughout its length:** connect the drain pipe (from rubber terminal) to the air conditioner (back side) after unplugged the black rubber cup (see picture P13). With this solution you can drain the condensate moisture to a suitable place to do not cause any problems to your neighbours

If use system "A", please do not unplug the black rubber cup from system "B".

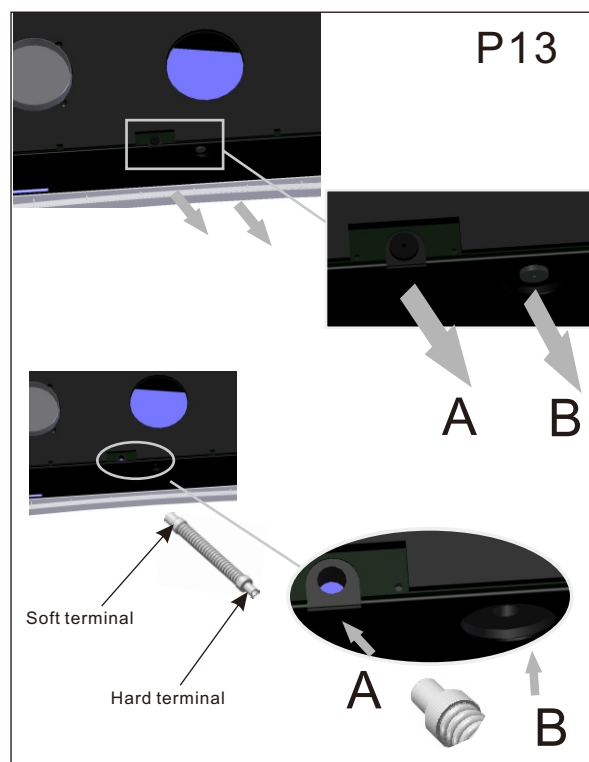

System "A" is more common use , and the discharge pipe go outside where there is no problem to connect or to discharge it , this solution is OK for hot country and normal cold temperature out side .

System "B": in case of impossibility to install the drainage pipe as showed on "A" system, please use system "B" to drain the condensate moisture to a suitable place.

If use system "B", please do not unplug the black rubber cup from system "A".

Usually "B" hole is used in the installation when the outside temperature is very low, and in this way we prevent no ice in the discharge water pipe. This solution is used also to be more easy for the installer to connect the internal drainage pipe when he don't want to see the pipe from outside.

2.4 FASTENING THE BRACKET (P6)

- Drill the holes for anchoring the fastening bracket to the wall using preferably the 6 holes showed in black on the paper template. If the wall is not sturdy enough it is advisable to use extra anchor bolts using the holes showed in grey on the paper template.
- The anchor bolts provided require a 8mm holes; the wall should be inspected to determine if provided bolts are useful or if it is necessary to use a different anchorage. The manufacturer is not liable in case of underestimation of the structural consistency of the anchorage made at the time of installation.

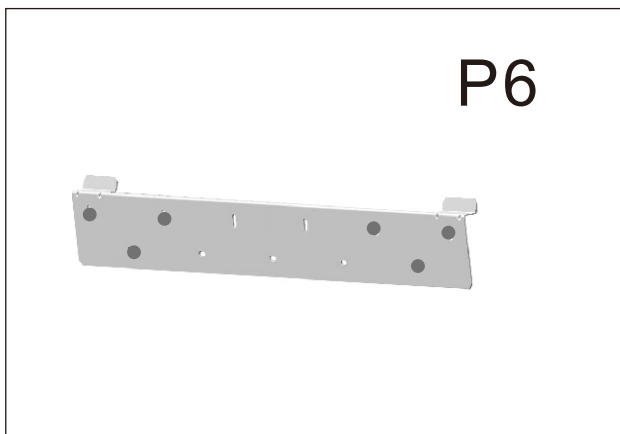

2.5 INSTALLATION OF THE PIPES (P20)

- After drilling the holes, the plastic pipes supplied with the air conditioner need to be fitted through them.
- The pipe with a diameter of 160mm (air discharge pipe) has to be fitted in the right hole. The length of the pipes should be same the depth of the wall plus 10mm. Use a normal hacksaw to cut the supplied pipes to the correct length. Remember that the modification must to have the same inclination of the holes (minimum 3 degrees).
- The tube diameter is nearly the same as that carried out using the 162 mm nominal diameter core drill therefore you may need to slightly force the introduction of the pipe using, in difficult cases, a normal rubber hammer and a small piece of timber to gently tap the tube into the hole.
- Insert the 160mm ring into the space between the wall and pipe.
- Please use the same instructions to fit the left hand tube (Fresh air intake) using the supplied pipe with a diameter of 150mm. The tube diameter is slightly smaller than that carried out using the 162 mm nominal diameter core drill.
- Insert the 150mm ring into the space between the wall and pipe.
- Please centre the pipes into the holes in the wall and insulate and seal their perimeters to prevent air and humidity infiltration using polyurethane foam and using plaster as finishing on the inside wall.

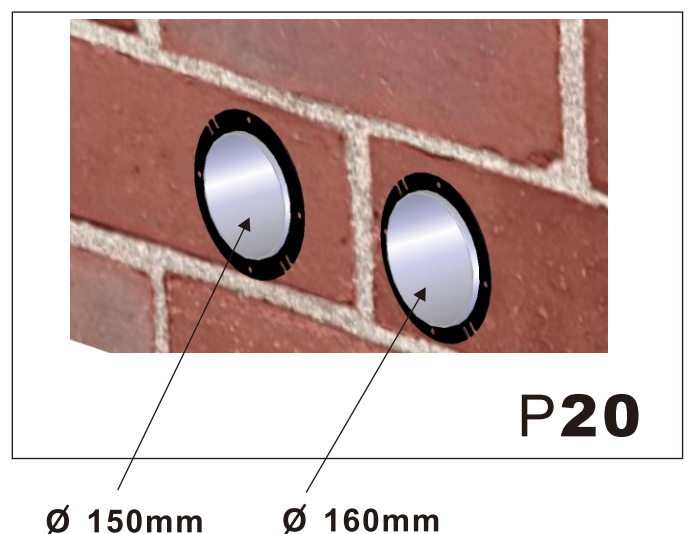

2.6 FITTING THE GRATINGS

(P7,P8,P9,P10)

To fit the external two gratings please proceed as follows: familiarise yourself with the fitting of the grating to the tube, before installation. Insert the cords through the centre of the grating. One grating fits on the outside of the tube and the other fits inside. The air discharge is the bigger hole and the grating therefore fits on the outside of the air discharge tube. Insert the supplied cord into the hole. Fold the outer grating in half grasping the cord with your free hand. Insert your arm inside the pipe with the grating and push all the way to the outside. Let the grating unfold and pull the cord toward you. One grating fits on the outside of the tube and the other fits inside. With a little patience and manipulation the 2 gratings will fit the end of the tubes. Grasping the cord, insert your fingers between the fins and pull the grating toward you until the same is properly slipped in the pipe, keeping the fins in vertical position.

If the external grating is accessible to prevent its removal, it is recommended to fasten it to the wall with wall plugs and screws with a diameter of 6 mm. Tighten the cord and fasten it to the dent on the internal flanges.



P9

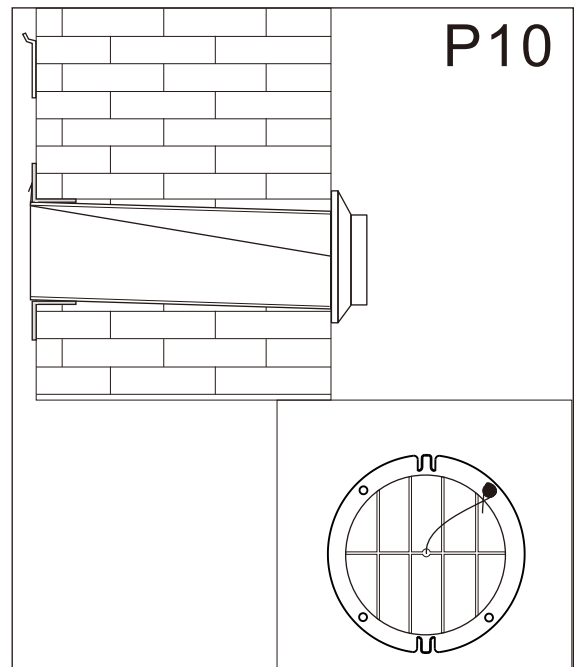

P10

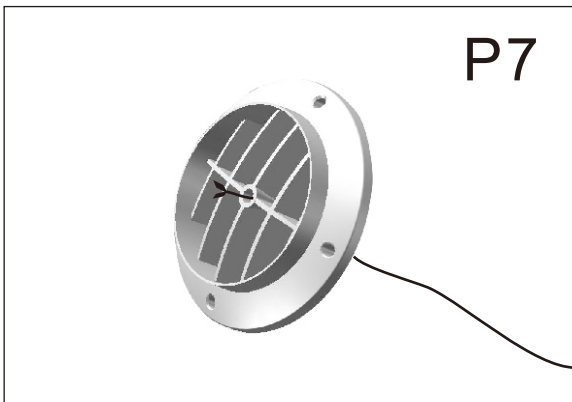

P7



P8

2.7 FITTING THE AIR CONDITIONER ON BRACKET (P11,P12)

After checking again that the fastening bracket is securely fastened to the wall, and that any necessary preparations for electric connection and condensate drainage (if it needs) have been made, fasten the air conditioner to its supporting bracket. Lift it up by holding the sides at the bottom. Tilt the air conditioner slightly toward you to facilitate the operation of fastening it to the bracket. The air conditioner can now be pushed firmly against the wall. Inspect carefully the installation to make sure that the insulating back panel must fit firmly against the wall and there are no fissures at the back of the air conditioner and that the two plastic semicircle on the back side of the air conditioner are placed inside of the two plastic hoses fixed inside the wall.



The appliance shall not be installed the laundry-dry.

The appliance must be positioned so that the plug is accessible

The appliance shall be installed in accordance with national wiring regulations.

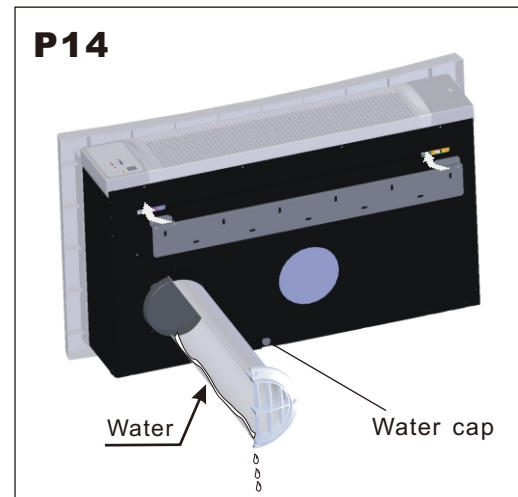
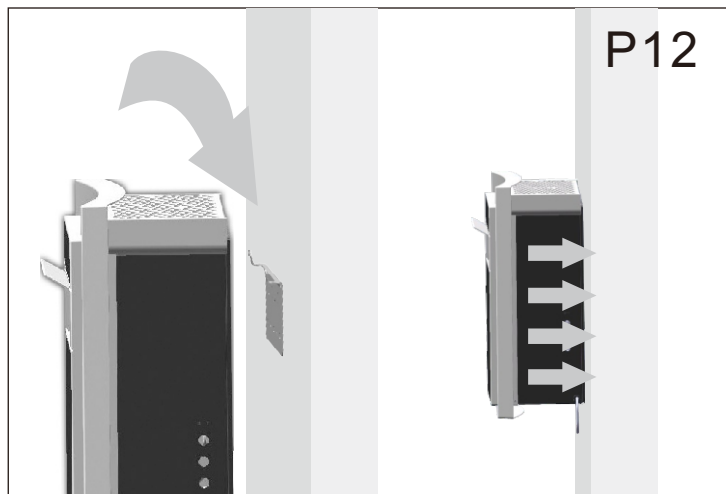
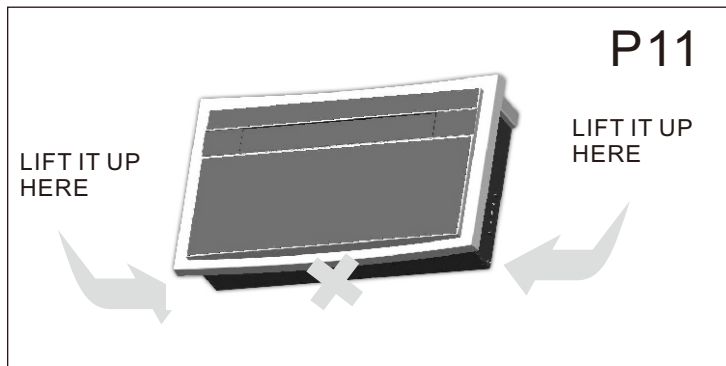

3.1 INTRODUCTION OF LCD ICONS

Icons	Meaning	Icons	Meaning
	Auto		Fan speed
	Cooling		Airflow direction
	DRY		Timer off
	Fan		Timer on
	Heating		Sleep
	Electrical Heat		TEMP
	Clock		Not Used

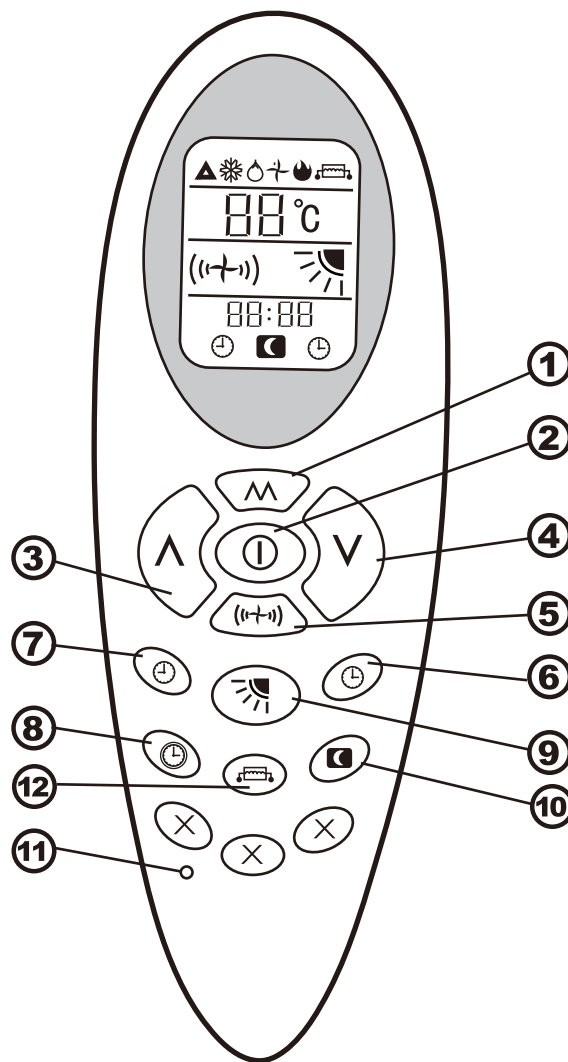







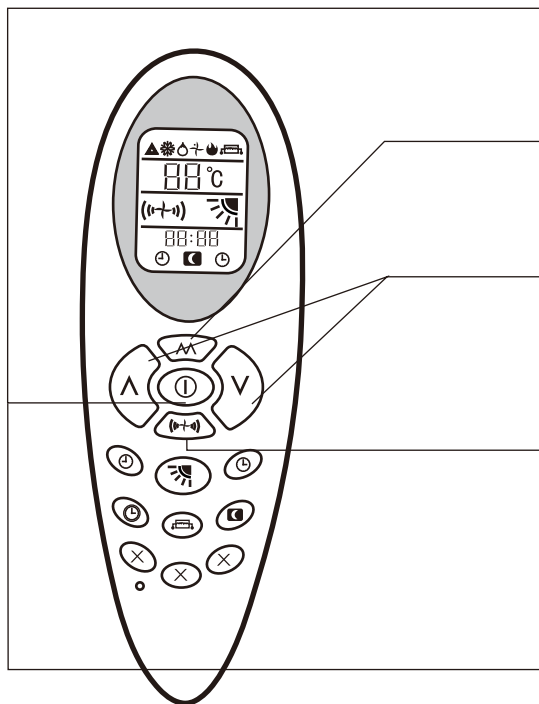



3.2 REMOTE CONTROL FUNCTIONS

- ① **MODE BUTTON:** Set up the air conditioner operating mode
- ② **ON/OFF BUTTON:** Turn on or turn off the air conditioner
- ③ **UP BUTTON:** Increase the temperature and time
- ④ **DOWN BUTTON:** Decrease the temperature and time
- ⑤ **FAN SPEED BUTTON:** Set up the fan speed.
- ⑥ **TIMER ON BUTTON:** Set up the time the air conditioner starts.
- ⑦ **TIMER OFF BUTTON:** Set up the time the air conditioner stops
- ⑧ **CLOCK BUTTON:** Adjust the clock
- ⑨ **LOUVER SWING BUTTON:** Adjust the airflow direction
- ⑩ **SLEEP BUTTON:** Automatically adjusting the setting temperature according the circadian rule.
- ⑪ **RESET BUTTON**
- ⑫ **ELECTRICAL HEAT BUTTON:** Switch on the electrical heat in order to get enough heating capacity in cold winter.

3.3 Heating mode









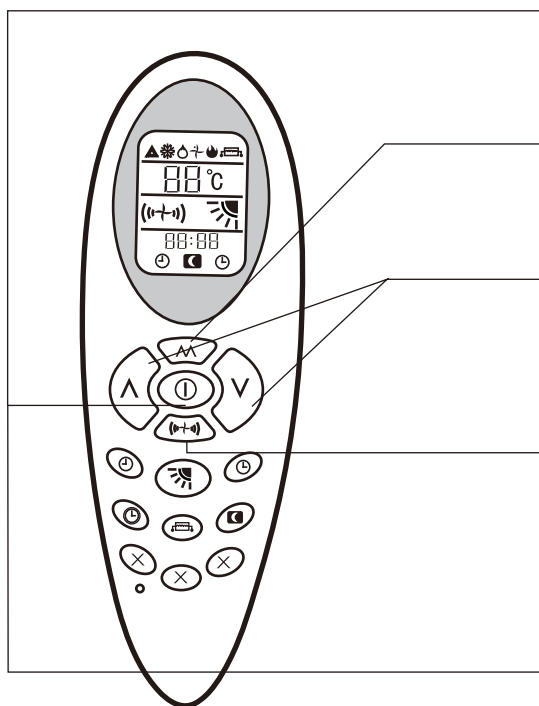

Sequence of the operations

- 1** Press the **ON/OFF** button “”, switch on the air conditioner, it will run by memory mode.
- 2** Press the **MODE** button “” set up the mode to heat “”, the air conditioner will run in heating.
- 3** Press **UP** “” or **DOWN** “” button, to adjust the setting up temperature
- 4** Press the **FAN SPEED** button “”, set up the fan speed  is low speed,  is middle speed,  is high speed,  (flashing) is auto fan , the speed is chosen by the difference of room temperature and setting temperature.
- 5** Press the **ON/OFF** button “”, switch off the air conditioner. Next time when this button is pressed, the air conditioner will operate in this mode by memory

3.4 Cooling mode



Sequence of the operations

- 1** Press the **ON/OFF** button “”, switch on the air conditioner, it will run by memory mode.
- 2** Press the **MODE** button “” set up the mode to cool “”, the air conditioner will run in cooling.
- 3** Press **UP** “” or **DOWN** “” button, to adjust the setting up temperature
- 4** Press the **FAN SPEED** button “”, set up the fan speed  is low speed,  is middle speed, is high speed, (flashing) is auto fan , the speed is chosen by the difference of room temperature and setting temperature.
- 5** Press the **ON/OFF** button “”, switch off the air conditioner. Next time when this button is pressed, the air conditioner will operate in this mode by memory

3.5 Dry mode

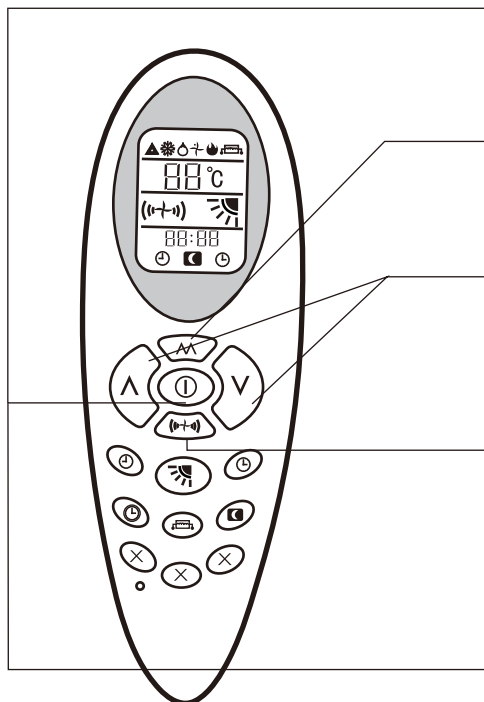

Sequence of the operations

- 1** Press the **ON/OFF** button “⓪” , switch on the air conditioner, it will run by memory mode.
- 2** Press the **MODE** button “^” set up the mode to dry “δ” , the air conditioner will run in dehumidifying.
- 3** Press **UP** “^” or **DOWN** “V” button, to adjust the setting up temperature
- 4** **FAN SPEED** button is “(f-f)” disable, indoor fan speed always is low in dry mode.f-f
- 5** Press the **ON/OFF** button “⓪” , switch off the air conditioner. Next time when this button is pressed, the air conditioner will operates in this mode by memory.

3.6 Fan mode

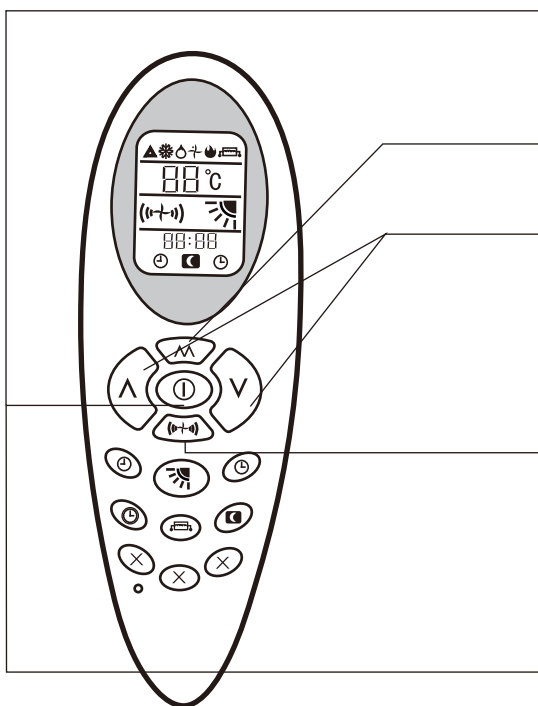

Sequence of the operations

- 1** Press the **ON/OFF** button “⓪” , switch on the air conditioner, it will run by memory mode.
- 2** Press the **MODE** button “^” set up the mode to fan “+” , the air conditioner will run in fan.
- 3** Press **UP** “^” or **DOWN** “V” button, to adjust the setting up temperature.
- 4** Press the **FAN SPEED** button “(f-f)” , set up the fan speed. f-f is low speed, f-f is middle speed, f-f is high speed, f-f (flashing) is auto speed.
Fan auto fan, the speed is chosen by the difference of room temperature and setting temperature.
Room temperature-setting temperature>5℃, high speed.
Room temperature-setting temperature>3℃, middle speed.
Room temperature-setting temperature>1℃, low speed.
- 5** Press the **ON/OFF** button “⓪” , switch off the air conditioner. Next time when this button is pressed, the air conditioner will operates in this mode by memory.

3.7 Sleep mode

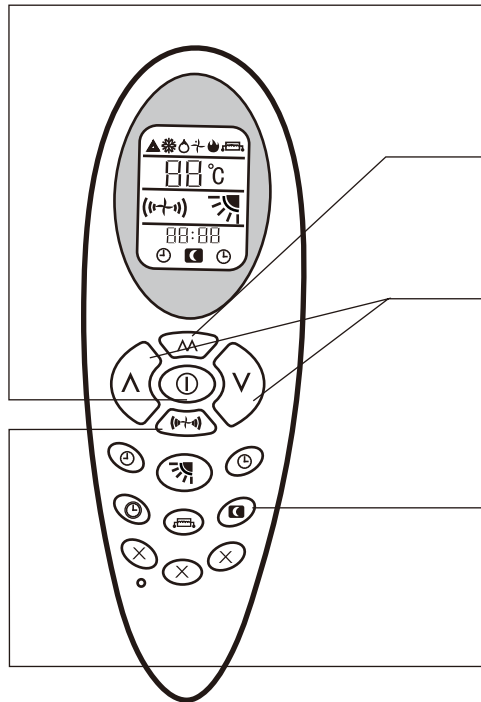

Sequence of the operations

- 1** Press the **ON/OFF** button “”, switch on the air conditioner, it will run by memory mode.
- 2** Press the **MODE** button “” set up the mode to cool “” /heat “” (heat pump)/auto “” , the air conditioner will run in setting mode.
- 3** Press **UP** “” or **DOWN** “” button, to adjust the setting up temperature
- 4** Press the **SLEEP** button “” ,this icon will display on LCD, sleep function is set up; press it again, cancel the sleep function.
- 5** If the sleep function is launched, the fan speed is steady in low speed.

3.8 Auto mode

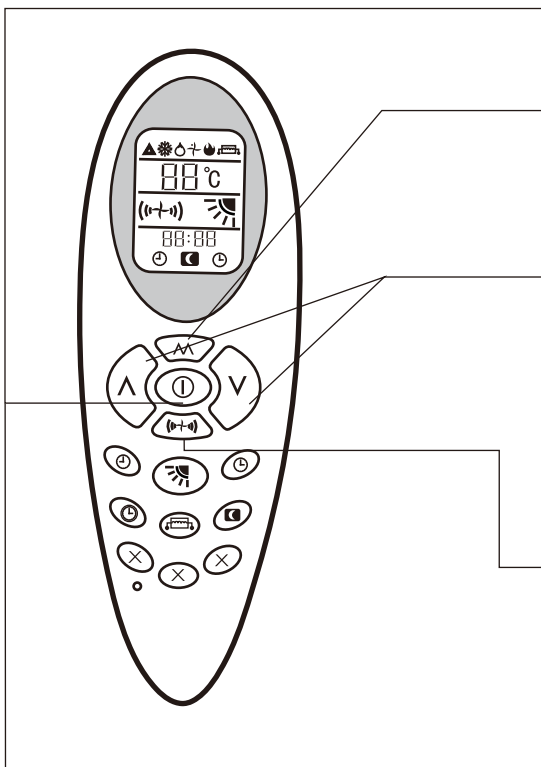

Sequence of the operations

- 1** Press the **ON/OFF** button “”, switch on the air conditioner, it will run by memory mode.
- 2** Press the **MODE** button “” , set up the mode to auto “” , the air conditioner will run in auto mode. (Reference to “emergency operation”)
- 3** According to the difference of room temperature and setting temperature automatically choose the running mode (cool, heat, fan). The temperature setting button UP “” and DOWN “” are disable.
When room temperature $\leq 20^{\circ}\text{C}$, run with heat mode.
When $20^{\circ}\text{C} < \text{room temperature} < 25^{\circ}\text{C}$, un with fan mode.
When room temperature $\geq 25^{\circ}\text{C}$, run with cool mode.
- 4** Press the **FAN SPEED** button “” , set up the fan speed.
 is low speed, is middle speed, is high speed, (flashing) is auto speed.
For auto fan, the speed is chosen by the difference room temperature and setting temperature.
- 5** Press the **ON/OFF** button “” , switch off the air conditioner. Next time when this button is pressed, the air conditioner will operates in this mode by memory.

3.9 Timer off function

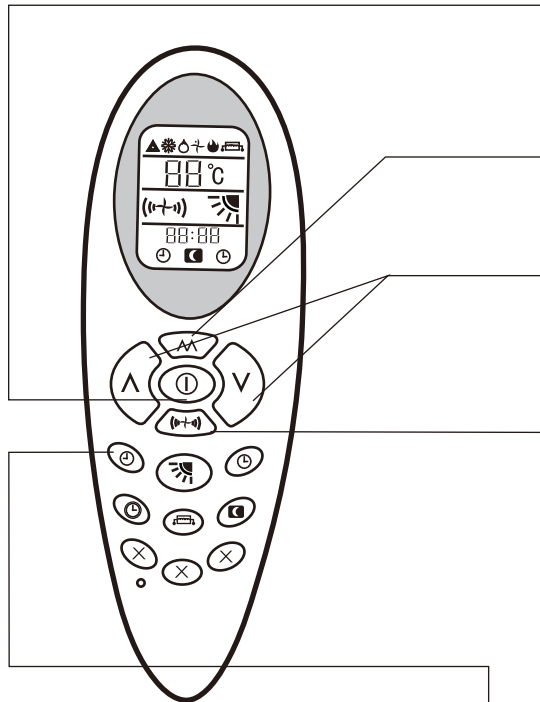

Sequence of the operations

- 1** Press the **ON/OFF** button “Ⓜ”, switch on the air conditioner, it will run by memory mode.
- 2** Press the **MODE** button “^” set up the mode to which you want.
- 3** Press **UP** “^” or **DOWN** “V” button, to adjust the setting up temperature
- 4** Press the **FAN SPEED** button “(+)”, set up the fan speed, (L) is low speed, (M) is middle speed, (H) is high speed, (A) (flashing) is auto speed. For auto fan, the speed is chosen by the difference of room temperature and setting temperature.
- 5** Press the **TIMER OFF** button “Ⓜ”, set up the time the air conditioner switch off. Press the button “^” each time, adjusting up 1 hour; Press the button “V” each time, adjusting up 1 minute; When the time is over, the air conditioner will be switched off automatically. If press this button again before the air conditioner switch off, the timer off setting will cancelled.



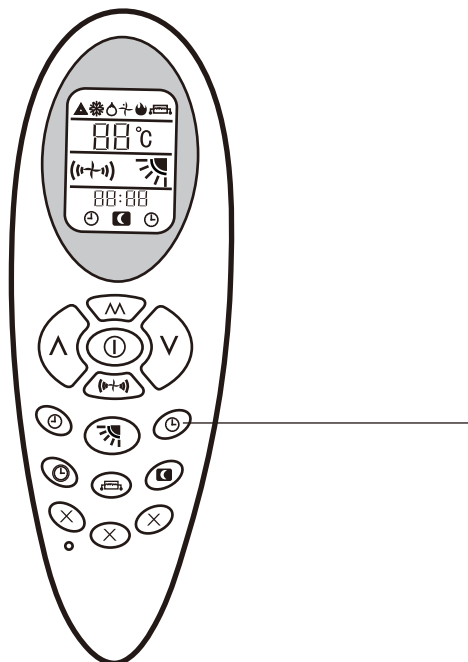









3.10 Timer on function



Sequence of the operations

- 1** The air conditioner is switched off.
- 2** Press the **TIMER ON** button “Ⓜ”, set up the time which the air conditioner switch on. Press the button “^” each time, adjusting up 1 hour; Press the button “V” each time, adjusting up 1 minute. Set up the operation **MODE, TEMPERATURE, FAN SPEED** etc., when the time is arrived, the air conditioner will start automatically. If the **TIMER ON** button is pressed again, the **TIMER ON** setting will be cancelled.

3. 11 Electrical heat function

- 1** Press the **ON/OFF** button “” , switch on the unit, it will run by memory mode.
- 2** Press the **MODE** button “” set up the mode to heat “” , the unit will run in heating.
- 3** Press **UP** “” or **DOWN** “” button, to adjust the setting up temperature
- 4** Press the **FAN SPEED** button “” , set up the fan speed.  is low speed,  is middle speed,  is high speed,  (flashing) is auto speed. For auto fan , the speed is chosen by the difference of room temperature and setting temperature.
- 5** Press the assistant **ELECTRICAL HEAT** button “” ,the icon will display on the LCD, starting the assistant heat; press this button again, stop the assistant heat.
- 6** Press the **ON/OFF** button “” , switch off the unit. Next time when this button is pressed, the unit will operates in this mode by memory.

3. 12 On board control function

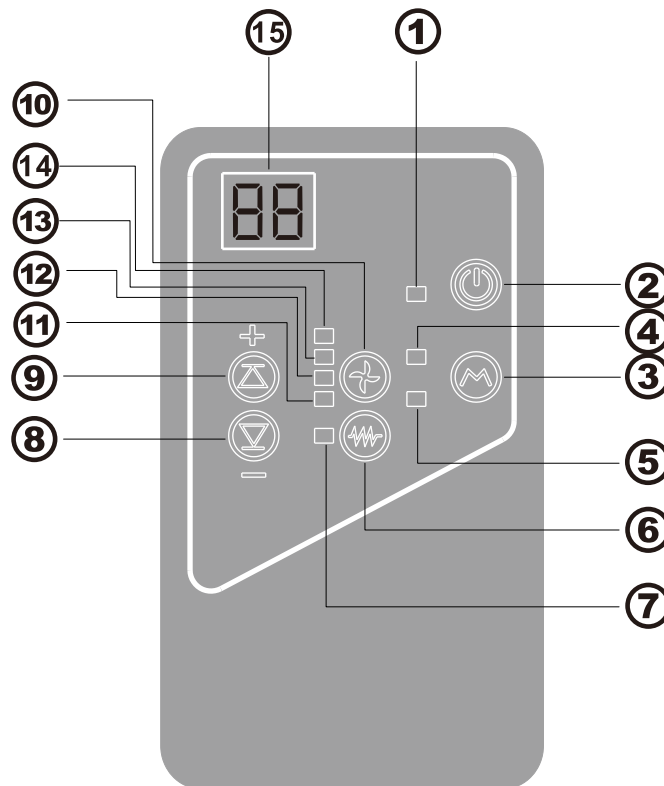

- ① RUNNING LED :Signal the working state of compressor
- ② ON/OFF BUTTON : turn on or turn off the air conditioner
- ③ MODE BUTTON : Set up the air conditioner operating mode
- ④ COOLING LED :Signal the cooling state
- ⑤ HEATING LED : Signal the heating state
- ⑥ ELECTRICAL HEAT BUTTON:Turn on or turn off the electrical heat.
- ⑦ ELECTRICAL HEAT LED: Signal the electrical heat state.
- ⑧ DOWN BUTTON : Decrease the temperature and time
- ⑨ UP BUTTON : Increase the temperature and time
- ⑩ FAN SPEED BUTTON : Set up the fan speed
- ⑪ HIGH SPEED LED : Signal the high speed working state
- ⑫ MIDDLE SPEED LED :Signal the middle speed working state
- ⑬ LOW SPEED LED :Signal the low speed working state
- ⑭ AUTO FAN LED : Signal the automatic fan state
- ⑮ Temperature display window

If you select the AUTO speed, the fan speed is according with the room temperature and setting temperature.

Room temperature-setting temperature $>5^{\circ}\text{C}$, high speed.

Room temperature-setting temperature $>3^{\circ}\text{C}$,middle speed.

Room temperature-setting temperature $>1^{\circ}\text{C}$,low speed.

- ⑮ Temperature display window

The display will show both setting temperature and ambient temperature. After adjusting the setting temperature, the setting temperature will flash 15 minutes on the display, then the display will show the ambient temperature for 70 seconds. After that, the display will be off until next adjustment.

3.13 Fresh air system

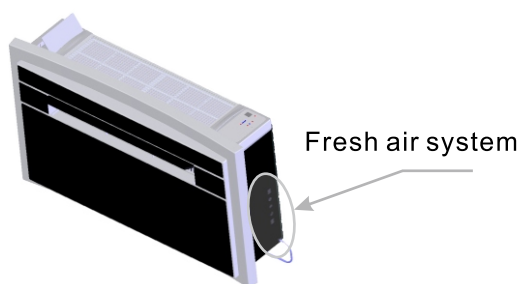

Fresh air system

Push here to open

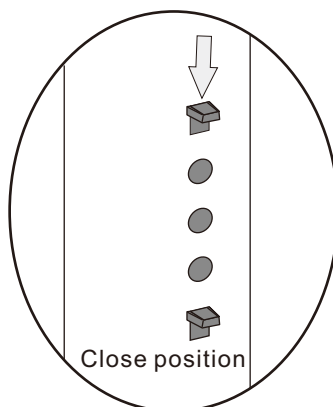

Close position

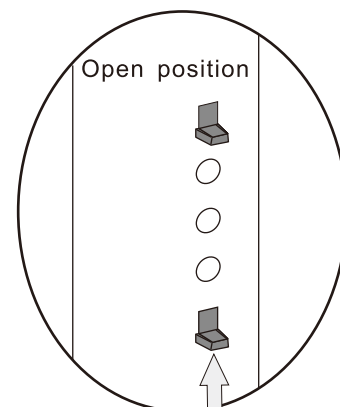

Open position

Push here to close

When the fresh air system is open the air conditioner will change the room air automatically : in this way new clean and fresh air will intake to the room. You can open or close the fresh air system any moment.

If the air fresh system is close the air conditioner performances are more high so we suggest to maintain the fresh air system closed and open it just a few minutes per day.

3.14 Install and change the battery

- Open the cover of battery, hold the hook and lightly pull up.
- Insert the battery (AAA,2pcs),the positive must be same with the mark on the plastic surface.
- Reinstall the cover of battery.
- Inspection: if press **ON/OFF** button “”, no icons are displayed, please install the battery again.

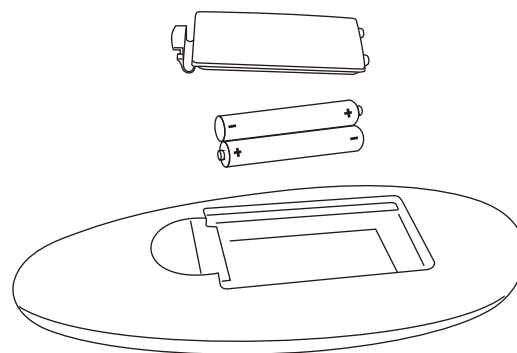

3.15 MAINTENANCE

(P15,P16,P17,P18)

FILTERS CLEANING:

The filters should be regularly cleaned to keep the air conditioner running efficiently. Clean the filters every two weeks.

How to proceed:

-Disconnect the air conditioner from the electrical supply.

-Extract the filter grating.(P15) on the same direction of the arrow.

Take out the filter as shown P17.

Proceed to wash them (not use hot water) and only when they are dried replace them in the same way.

ATTENTION: Do not use the air conditioner without filters as it could seriously damage the air conditioner.

EXTERNAL CLEANING:

-Disconnect the air conditioner from the electrical supply.

-Wipe external surfaces clean with a damp cloth only.

-Do not use an abrasive cloth and/ or solvents, as this may damage the surfaces.

-Do not use excessively wet cloths or sponges, as water stagnation could damage the air conditioner and compromise safety.

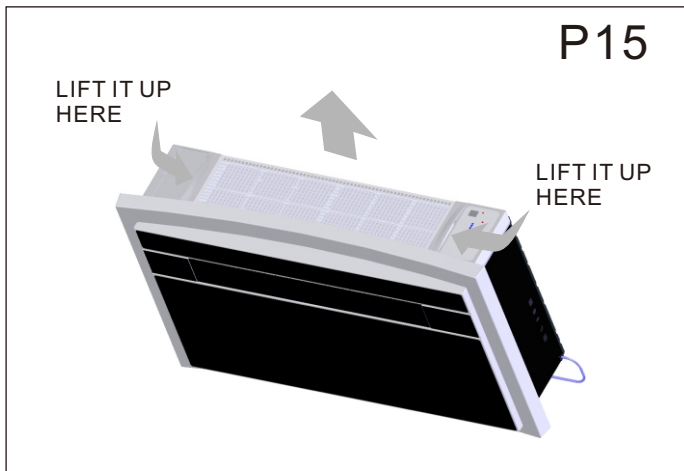
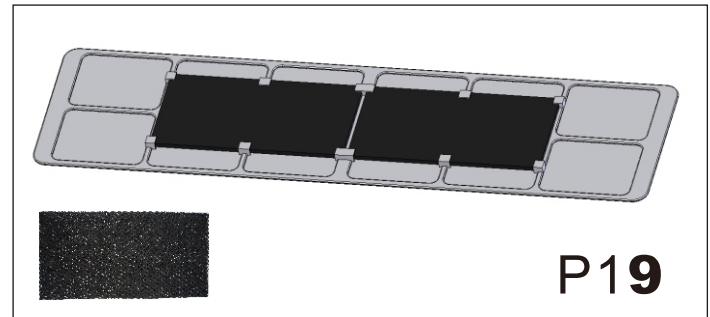
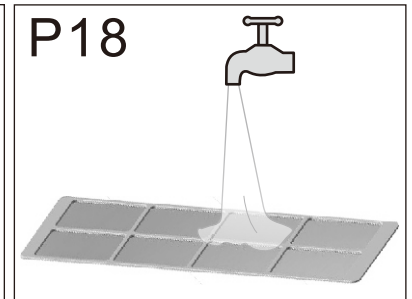
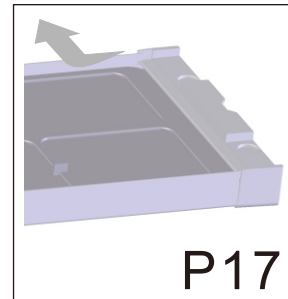
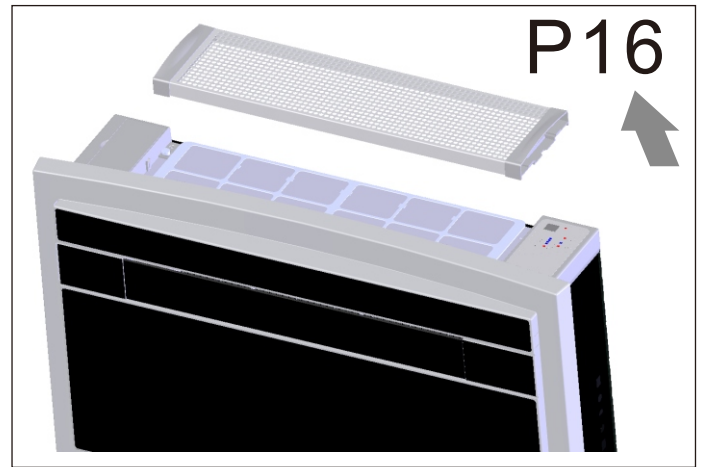

ACTIVE CARBON FILTER

The unit includes active carbon filter, which not only has the function of eliminating suspended matters that a common mechanical filter has, but also can eliminate foreign matters such as free chlorine, odors, colors and toxic matters that are difficult to filter out by using conventional approaches. With active carbon filter, the room air would be fresh and good for the body health.

Is advisable to change them every three month , because it's not possible to wash or clean them.

POSITION OF ELECTRICAL HEATER

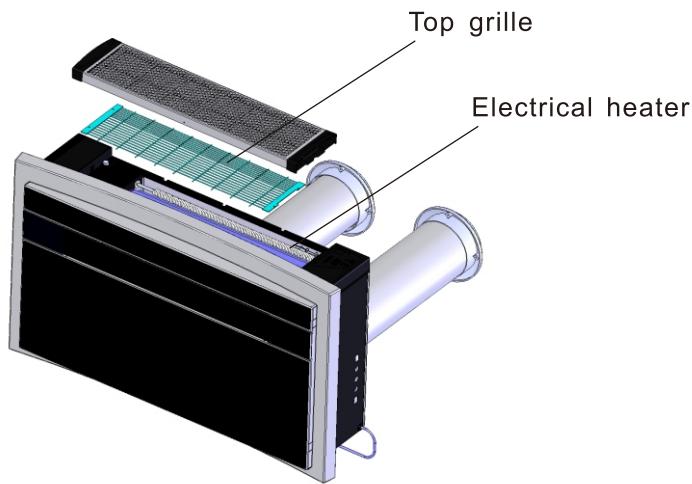

Electrical heater is positioned in the top of the machine, and it is protected by the top grille.

3.16 PROBLEM SOLVING

PROBLEM POSSIBLE CAUSES

- The air conditioner does not work.
- The air conditioner does not refrigerate the room
- Strange smell in the room. Water drips from the air conditioner.
- The remote control does not work.
- The air conditioner does not work for 3 minutes when switched on.

POSSIBLE SOLUTIONS

1. Wrong setting of the timer / Check it.
2. Problems on the power supply/Call the service center.
- 3.The filter could be dirty / Clean it.
- 4.The room temperature is too high / Wait until the temperature goes down.

5. The temperature is not properly set/Check it.

6.The grids could be obstructed / Check and remove the eventual obstacles.

-Dampness in the room, coming from walls, carpets, furnishing or similar

-Wrong installation of the air conditioner.

-Wrong connection of the drainage pipe.

-Exhausted batteries.

-Wrong insertion of the batteries inside the remote control

-Protection of the air conditioner. Wait for 3 minutes and the air conditioner will start to work again.



If the supply cord damaged, it must be replaced by manufacturer or its service agent or a similarly qualified person in order to avoid a hazard.

The max operation temperature for the air conditioner (max cooling: outdoor DB43°C / WB26°C, indoorDB32°C / WB23°C; min heating: outdoor DB-5°C / WB-6°C, indoor DB20°C)

This appliance is not intended for use by persons (including children) with reduced physical, sensory or mental capabilities, or lack of experience and knowledge, unless they have been given supervision or instruction concerning use of the appliance by a person responsible for their safety. Children should be supervised to ensure that they do not play with the appliance.

<p>Smaltimento delle apparecchiature obsolete Disposal of your old appliance Entsorgung von Altgeräten Élimination des appareils obsolètes Como deshacerse de aparatos eléctricos y electrónicos viejos Eliminação do seu antigo aparelho</p>	
--	---

IT

Smaltimento delle apparecchiature obsolete

1. Quando su n prodotto è riportato il simbolo di un bidone della spazzatura sbarrato da una croce significa che il prodotto è coperto dalla Direttiva Europea 2002/96/EC.
2. Tutti i prodotti elettrici ed elettronici dovrebbero essere smaltiti separatamente rispetto alla raccolta differenziata municipale, mediante impianti di raccolta specifici designati dal governo o dalle autorità locali.
3. Il corretto smaltimento delle apparecchiature obsolete contribuisce a prevenire possibili conseguenze negative sulla salute umana e sull'ambiente.
4. Per informazioni più dettagliate sullo smaltimento delle apparecchiature obsolete, contattare il comune, il servizio di smaltimento rifiuti o il negozio in cui è stato acquistato il prodotto.

FR

Élimination des appareils obsolètes

1. Quand figure sur un produit le symbole représentant une poubelle barrée d'une croix, cela indique que le produit est assujéti à la Directive européenne 2002/96/EC.
2. Tous les appareils et composants électriques et électroniques doivent être éliminés auprès de déchetteries spécifiques indiquées par les pouvoirs publics nationaux ou par les autorités locales.
3. La bonne élimination des appareils obsolètes contribue à prévenir les conséquences dommageables pour la santé des personnes et pour l'environnement.
4. Pour plus d'informations concernant l'élimination des appareils obsolètes, veuillez contacter votre mairie, le service d'élimination des ordures ou encore le magasin où le produit a été acheté.

UK

Disposal of your old appliance

1. When this crossed-out bin symbol appears on a product it means that the product is covered by European Directive 2002/96/EC.
2. All electrical and electronic products should be disposed of separately from the municipal waste stream via specific collection facilities designated by the government or the local authorities.
3. Proper disposal of your old appliance will help prevent potential negative consequences for the environment and human health.
4. For more detailed information about disposal of your old appliance, please contact your municipality, the waste disposal service or the shop where you purchased the product.

ES

Como deshacerse de aparatos eléctricos y electrónicos viejos

1. Si en un producto aparece el símbolo de un contenedor de basura tachado, significa que este se acoge a la Directiva 2002/96/EC.
2. Los aparatos eléctricos no se deben desechar junto con los residuos domésticos, sino a través de puntos de recogida designados por el gobierno o las autoridades locales.
3. La correcta recogida y tratamiento de los dispositivos inserivbles contribuye a evitar riesgos potenciales para el medio ambiente y la salud pública.
4. Para obtener más información sobre cómo deshacerse de sus aparatos eléctricos y electrónicos viejos, póngase en contacto con su ayuntamiento, el servicio de recogida de basuras o el establecimiento donde adquirió el producto.

DE

Entsorgung von Altgeräten.

1. Wenn dieses Symbol eines durchgestrichenen Abfallimers auf einem Produkt angebracht ist, unterliegt dieses Produkt der europäischen Richtlinie 2002/96/EC.
2. Alle Elektro- und Elektronik-Altgeräte müssen getrennt vom Hausmüll über dafür staatlich vorgesehene Stellen entsorgt werden.
3. Eine ordnungsgemäße Entsorgung des Altgeräts trägt dazu bei, Schäden an der Umwelt und der menschlichen Gesundheit zu vermeiden.
4. Weitere Informationen zur Entsorgung des Altgeräts erhalten Sie bei der Stadtverwaltung, beim Entsorgungsamt oder in dem Geschäft, in dem Sie das Produkt erworben haben.

PT

Eliminação do seu antigo aparelho

1. Quando este símbolo de caixote do lixo com uma cruz em cima estiver afixado a um produto, significa que o produto se encontra abrangido pela Directiva Europeia 2002/96/EC.
2. Todos os produtos eléctricos e electrónicos devem ser eliminados separadamente do lixo doméstico através de pontos de recolha designados para o efeito pelo governo ou pelas autoridades locais.
3. A eliminação crrecta do seu aparelho antigo ajuda a evitar potenciais consequências negativas para o ambiente e para a saúde humana.
4. Para obter informações mais detalhadas acerca da eliminação do seu aparelho antigo, contacte as autoridades locais, um serviço de eliminação de resíduos ou a loja onde comprou o produto.