

# Asennusohje - OCEAN 6+3

---



## Sisällys

HOITO-OHJEET .....	1
KIERRÄTYS .....	1
TYÖKALUT .....	2
OSAT .....	2
KIINNITYSPROFIILIN ASENNUS SEINÄÄN .....	3
LAAHUSTIIVISTEEN ASENNUS .....	4
SUIHKUSEINÄN ASENNUS KIINNITYSPROFIILIIN .....	5
SUIHKUSEINÄN TUKI .....	6
OVIKULMAN SÄÄTÖ .....	7

## HOITO-OHJEET

Lika ja tahrat poistetaan tavallisella saniteettitilojen puhdistusaineella tai astianpesuaineella runsaasti vettä käyttäen. Huuhtelun jälkeen lasi kuivataan huolellisesti lastalla, jotta vältetään kalkkitahroilta.

Kalkkitahroja syntyy kun kalkkipitoinen vesijohtovesi kuivuu jättäen lasiin valkoisia tahroja. Mahdolliset kalkkitahrat poistetaan etikkahappoliuoksella (pöytäetikka laimennettuna). Hankaukseen käytetään ikkunanpesuliinaa. Lasi huuhdellaan runsaalla vedellä ja kuivataan lopuksi lastalla.



## KIERRÄTYS

1. Käytä suojalaseja ja -käsineitä.
2. Irrota ovet ja lasiseinät.
3. Irrota kaikki metalliosat lasista.
4. Irrota tiivisteet ovista.
5. Kokoa irtonaiset roskat erikseen ja kierrätä lasi, metalli, ruuvit ja muovi alla olevan ohjeen mukaisesti.
  - METALLI TOIMITETAAN METALLINKERÄYKSEEN
  - RUUVIT TOIMITETAAN METALLINKERÄYKSEEN
  - LASI TOIMITETAAN LASINKERÄYKSEEN
  - MUOVILISTAT TOIMITETAAN MUOVINKERÄYKSEEN
  - MUOVIOSAT TOIMITETAAN MUOVINKERÄYKSEEN







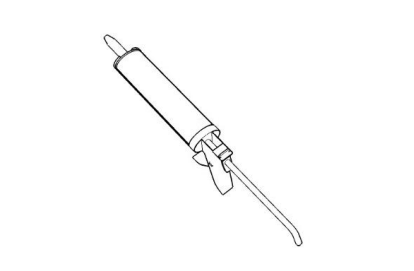
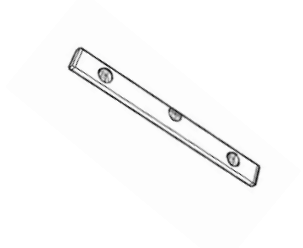
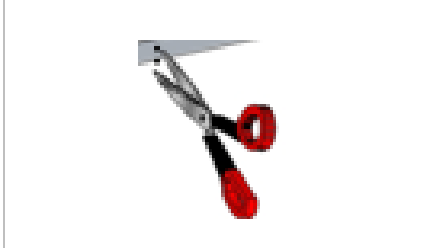

Hae ohjeet tarvittaessa [www.vihtaovet.fi](http://www.vihtaovet.fi)

TYÖKALUT

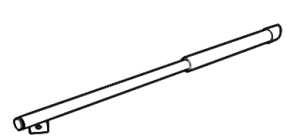
OSAT

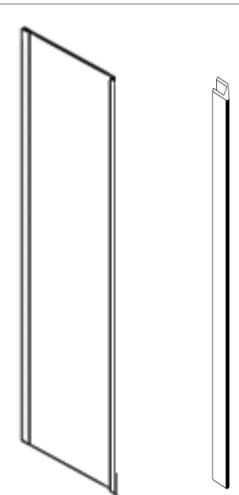
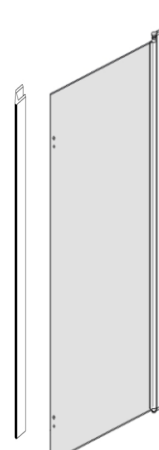
	x 6		x 6		x 1
	x 6		x 6		
	x 2		x 2		x 2
	x 2		x 2		x 1

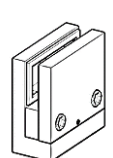
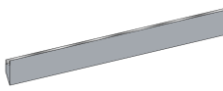
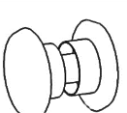
KIINNITYSPROFIILIN ASENNUS SEINÄÄN

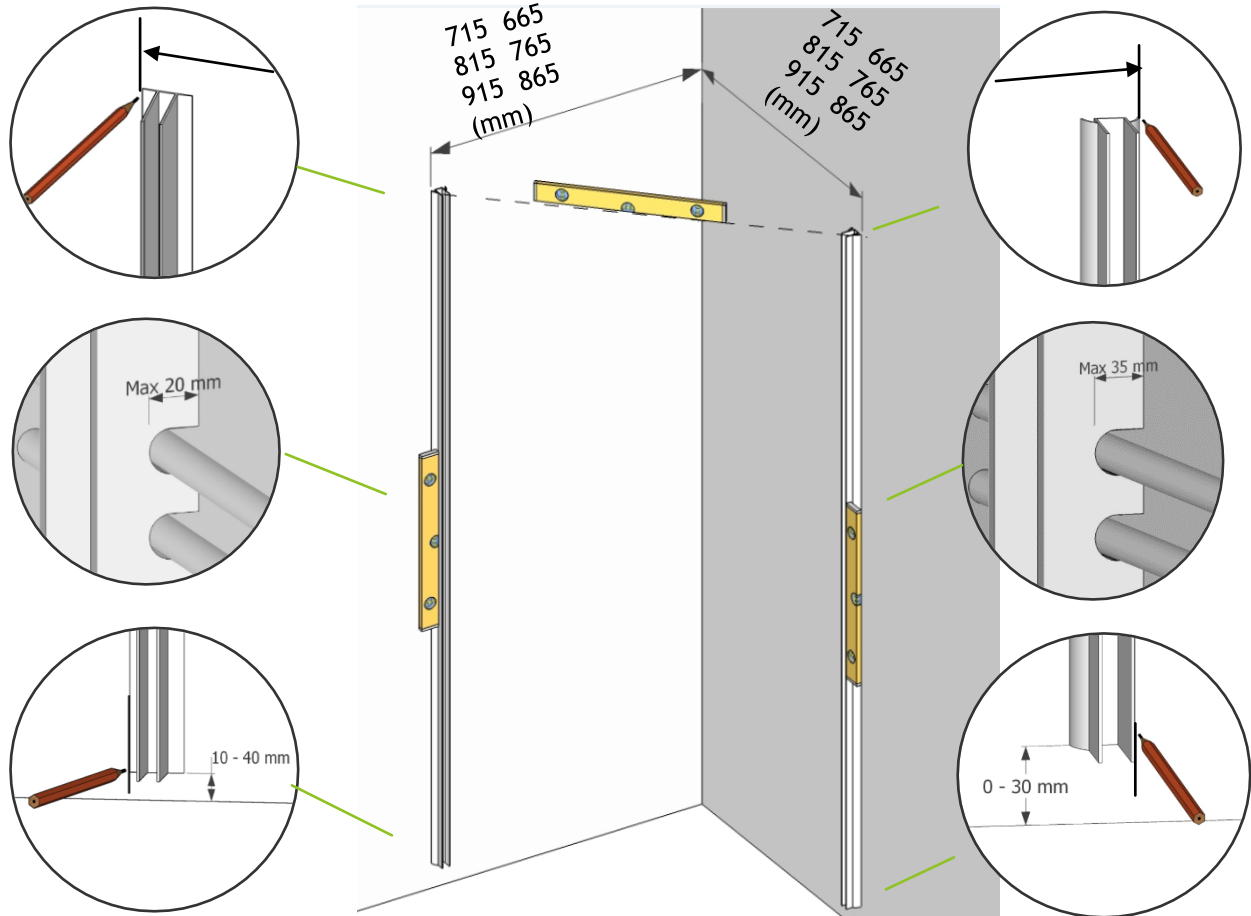

\*huomio lattian kaato

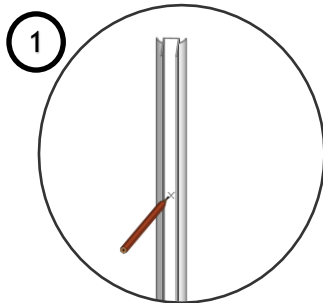

X 3



X 3

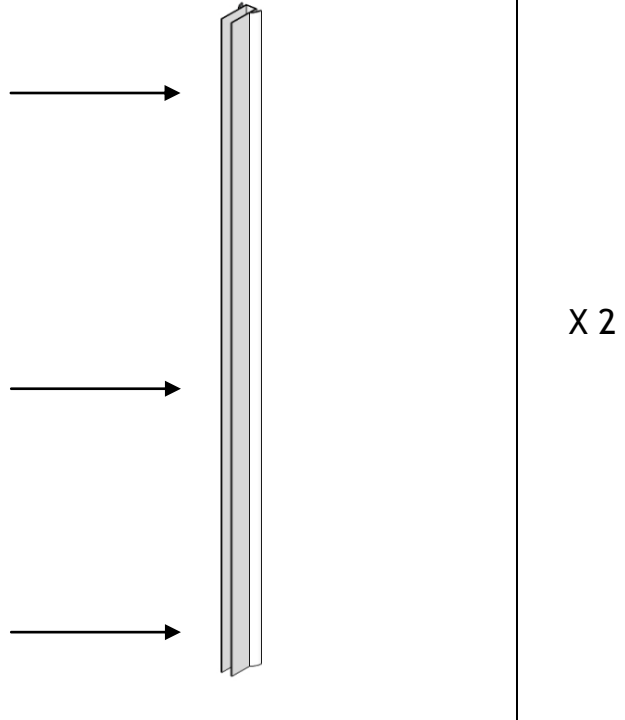

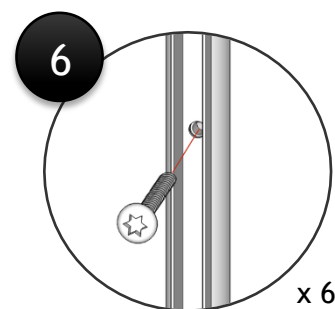
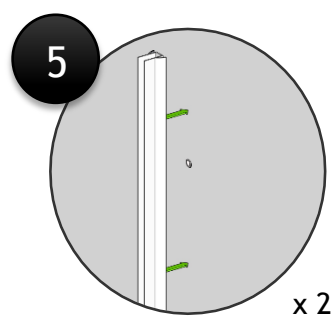
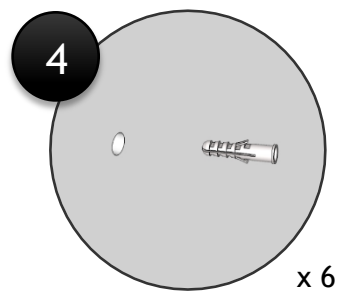
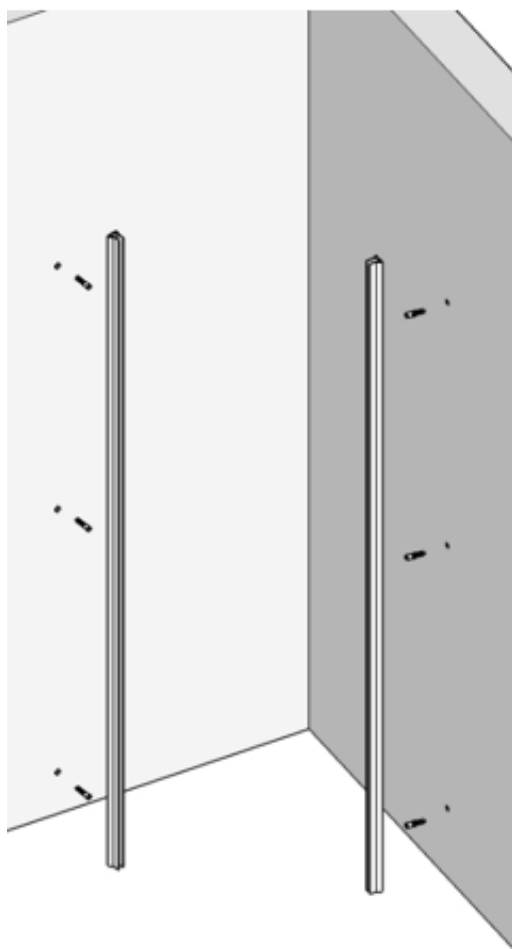
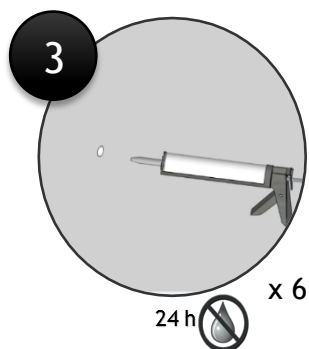
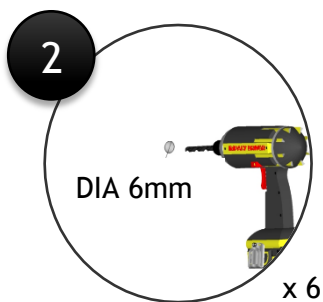
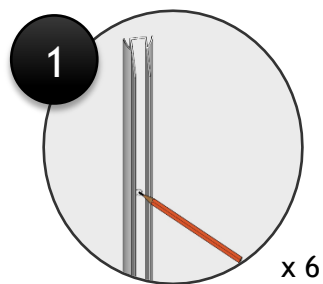

### LAAHUSTIIVISTEEN ASENNUS

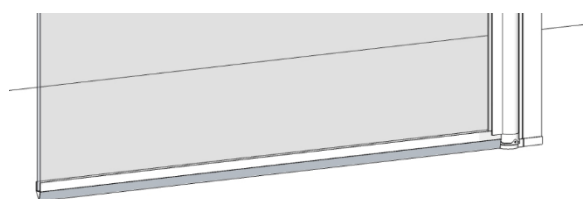
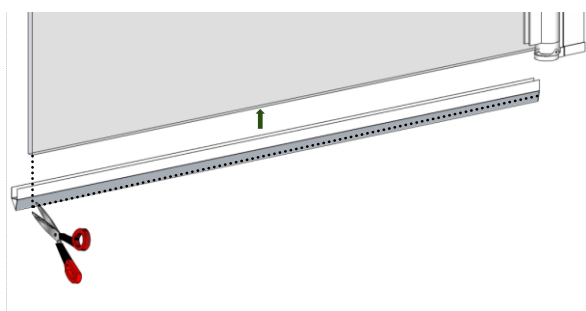

SUIHKUSEINÄN ASENNUS KIINNITYSPROFIILIIN

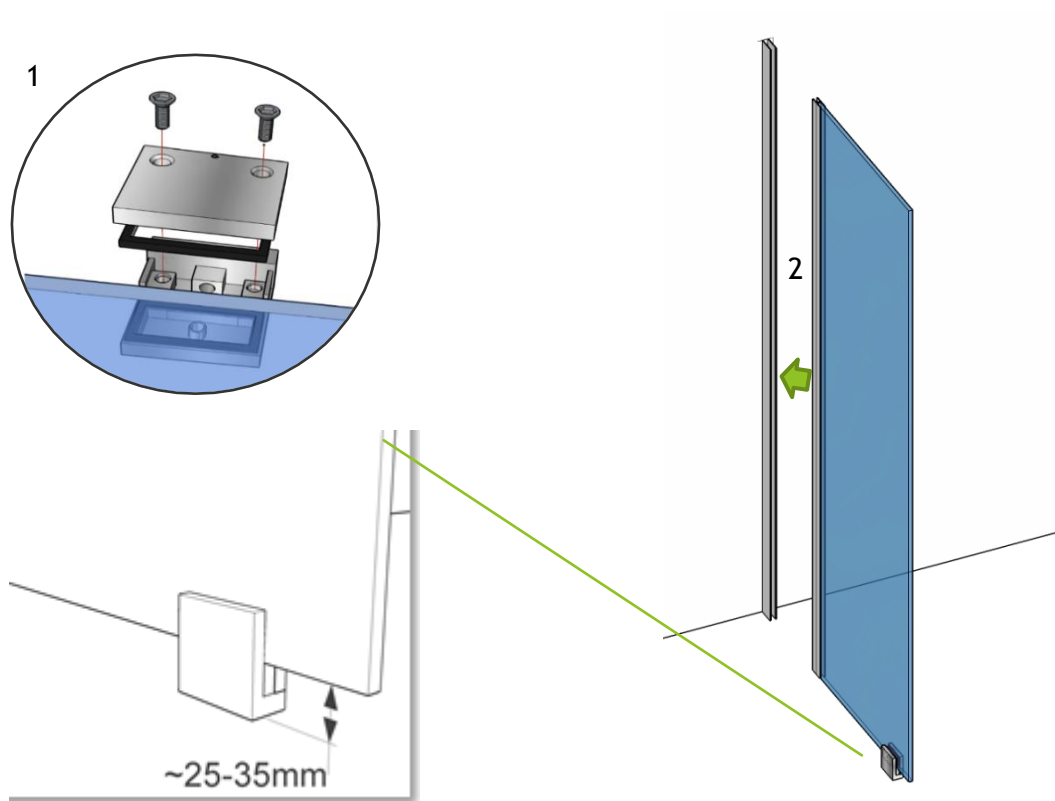

pystysäätö ±7mm

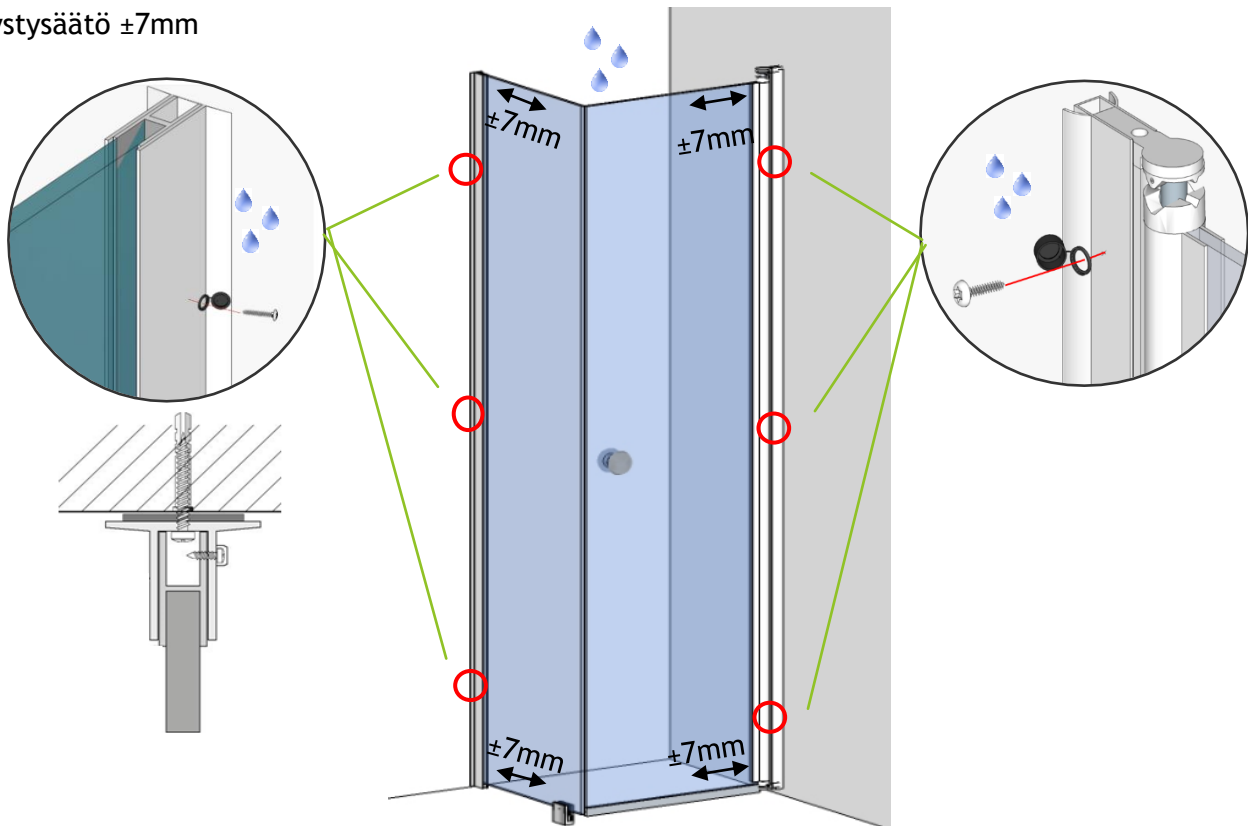

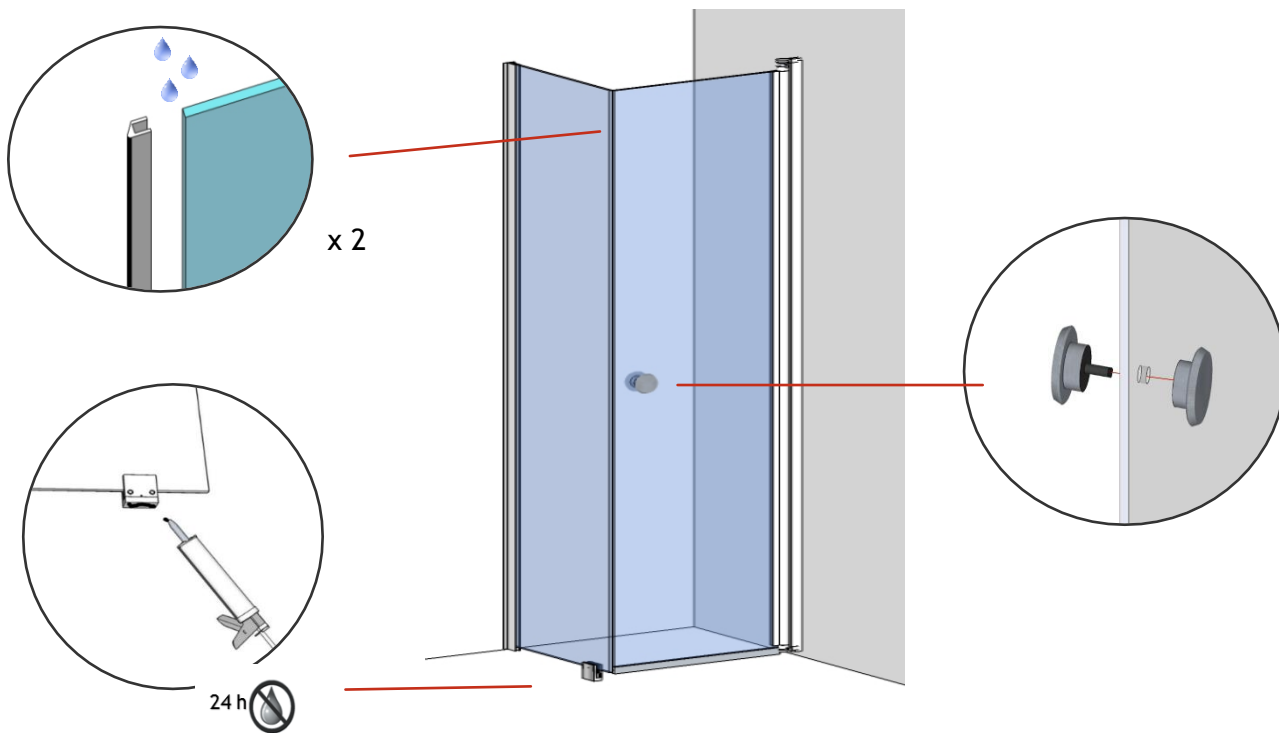

### SUIHKUSEINÄN TUKI

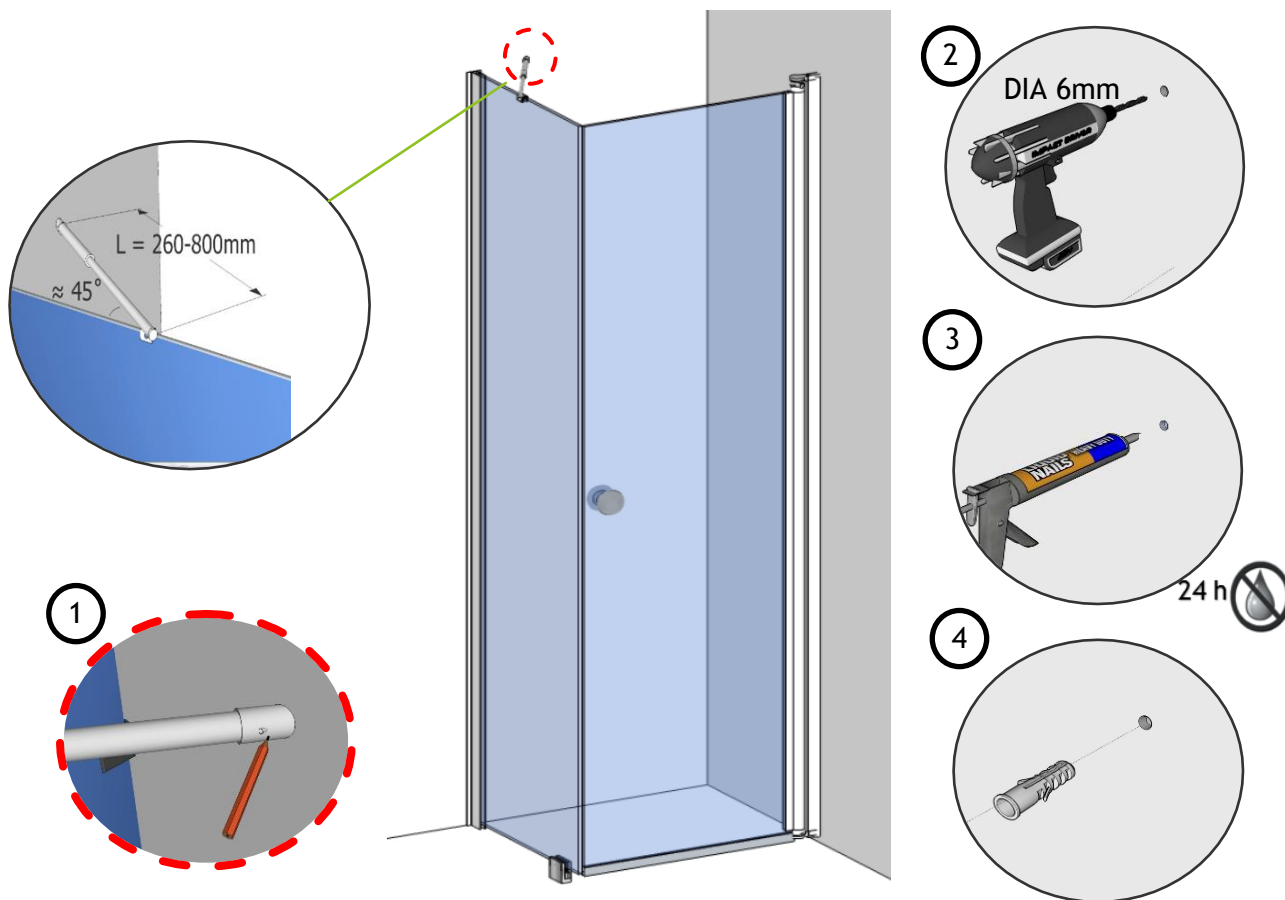

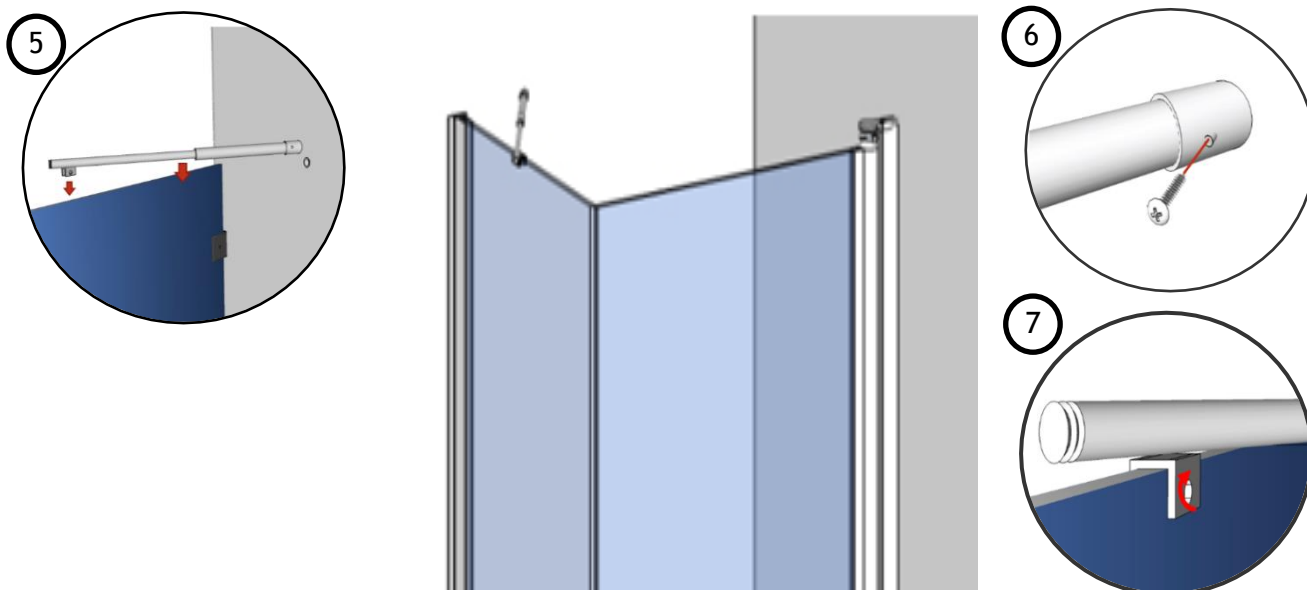

### OVIKULMAN SÄÄTÖ

